

DIXON

DPL417



The Right Connection®

DIXONVALVE.COM
877.963.4966



The Right Connection®

2017 Table of Contents

Engineered Fluid Transfer Couplings



Bayloc™ dry disconnect couplers and adapters, Mann Tek dry disconnect couplers and safety breakaways, FloMAX fluid nozzles, API couplers, vapor recovery couplers, pipe caps, drop elbows, swivel joints, railroad unloading assemblies

A pgs.
Aiv - A52

ADS Industrial Fluid Controls



Outalarms, Spillguard™ monitors, probes, cables, outage gauges, open dome adapter, gauge rods

B pgs.
Bi - B6

Coupling Systems



Boss™ ground joint complete females, stems and wing nuts, Boss™ clamps, frac fittings, external swage stems, scovill style couplings, tri-clover stems, fixed welded flanges, combination nipples, short ferrules

C pgs.
Ci - C51

Cam & Groove



Dixon®, Boss-Lock™, EZ Boss-Lock™, swaged-on and phonograph finish, polypropylene, reducing couplers, adapters, gaskets, replacement handles, accessories, Strap-Grip

D pgs.
Dii - D68

Industrial Hose Fittings



King™ combination nipples, shank suction couplings, strainers, threaded foot valves, hose menders, hose barbs and inserts, push-on hose barbs, garden hose fittings, Agri-Lock and Bauer style couplings, expansion ring couplings

E pgs.
Ei - E72

Clamps, Sleeves and Ferrules



Worm gear clamps, t-bolt clamps, single and double bolt clamps, spiral clamps, clamp hand tools, single and double ear clamps, short crimp sleeves, notched NOS ferrules, band clamps, Air King™ clamps

F pgs.
Fi - F27

Pneumatic Fittings



Sand blast couplings, Surelock™ hose ends, Dix-Lock™ interchange couplers and plugs, Dual-Lock™ couplers and plugs, Air Chief industrial and automotive male and female fittings, Parker E-z mate industrial couplers, King™ cables, air receiver manifolds, FRL's, blow guns, gauges, air brake fittings

G pgs.
Gii - G164

Hydraulic Fittings



Hydraulic couplings, food grade silicone flanged couplers, dust caps and plugs, threaded plugs, hose barbs, extension plugs, push-loc barbs, blowout prevention safety couplers, wingstyle threaded couplers, connectors, elbows, tees, bolt flanges, pipe and tube clamps

H pgs.
Hi - H81

Valves



Bronze ball valves, mini ball valves, industrial wafer ball valves, nozzle valves, butterfly valves, flow control valves, needle valves, angle hose valves, wye valves, siamese connections, sanitary valves

I pgs. Iii - I88

Pipe, Welding and Tube Fittings



NPT threaded pipe fittings, pipe nipples, Tuff-Lite™ threaded fittings, swage nipples, hammer unions, instrumentation fittings, SAE flare fittings, push to connect fittings, hydrant adapters, sanitary clamps, european fittings, sight glasses

J pgs. Ji - J197

Nozzles, Spray Guns and Accessories



Petroleum fuel nozzles, fire nozzles, washdown nozzles and stations, spray guns and accessories, soap nozzles

K pgs. Kii - K40

Hose and Tubing



Mill hose, washdown hose, fire hose, racks and reels, garden hoses, PVC tubing, polyurethane tubing, hose cutters, spiral hose

L pgs. Li - L42

Maintenance and Repair



Thread tape and sealant, hydrostatic test pumps, spill kits, grease whip hose assemblies and fittings, oxy-acetylene fittings, torque wrenches

M pgs. Mi - M16

Technical

Metal	Non-Metal	Gasket/Seal Material
1 = Excellent 2 = Good 3 = Fair X = Not Recommended -- Contact Dixon®	A = Acceptable X = Not Recommended -- Contact Dixon®	T = PTFE V = FKM E = EPDM, EPR N = Neoprene B = Buna N



Dixon® hose coupling workshop, SOS van, safety information, pressure recommendations, corrosion resistance of coupling material

N pgs. Ni - N15

Tab Descriptions



A-Engineered Fluid Transfer Couplings



F-Clamps, Sleeves and Ferrules



K-Nozzles, Spray Guns and Accessories



B-ADS Industrial Fluid Controls



G-Pneumatic Fittings



L-Hose and Tubing



C-Coupling System



H-Hydraulic Fittings



M-Maintenance and Repair



D-Cam & Groove



I-Valves



N-Technical



E-Industrial Hose Fittings



J-Pipe, Welding and Tube Fittings

A - Engineered Fluid Transfer Couplings



Gravity drop adapter dust caps
page A-26



Vapor recovery coupler x
45° hose shank
page A-29



TTMA flange sight flow indicators
page A-33



Split flange swivels
page A-47

B - ADS Industrial Fluid Controls

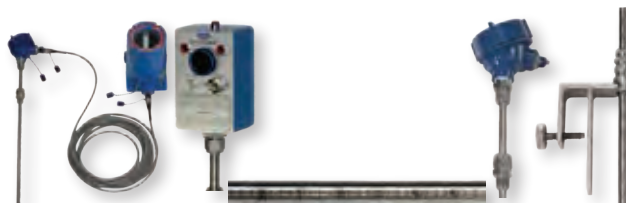

Outalarms, Spillguard™ monitors, probes, cables
page B-2 to B-6

D - Cam & Groove



EZLink™ armless cam and groove
page D-7 to D-8



Boss-Lock™ coupler x
tube with 45° cut
page D-43



Global adapter x TTMA flange
page D-60



Polypropylene dust caps and plugs
page D-68

E - Industrial Hose Fittings



Long shank GHT couplings
page E-42

G - Pneumatic Fittings



Nylon King Cable™
page G-47

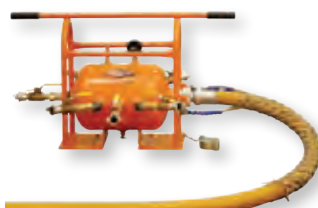

ASME manifold with King™ safety
whipsock for supply hose
page G-48



Watts compact filters manual drain
page G-112



Watts compact lubricators zinc bowl
sight glass with twist drain
page G-115

I - Valves



Betts Wet-R-Dri™ butterfly valves
page I-18



3A sample valve with manual handle
page I-73

J - Pipe, Welding and Tube Fittings



Lead free brass female hex
couplings, adapters
page J-5, J-7



ANSI flat face flange x
male NST (NH)
page J-37



Painted iron clamps with Baylast™
gaskets
page J-43

K - Nozzles, Spray Guns and Accessories



Pressure spray gun
page K-32

L - Hose and Tubing



Kevlar® protective sleeves
page L-40

Dry Disconnects A-2 to A-12

Bayloc™ style.....	A-2 to A-4
Coupler x female NPT.....	A-2
Greaseless coupler x female NPT	A-2
Coupler locking kit.....	A-2
Adapter x female NPT.....	A-3
Jump size adapter x female NPT	A-3
Adapter x 150# ASA flange.....	A-3
Vapor adapter x female NPSM	A-4
Cam & groove actuator style couplers.....	A-4
Bayonet style.....	A-5
90° swivel coupler x female NPT	A-5
Straight coupler x female NPT	A-5
Straight swivel coupler x female NPT	A-5
Dust plugs	A-5
Adapter x female NPT.....	A-5
Dust caps	A-5
Mann Tek style.....	A-6 to A-12
Coupler hose unit x female NPT	A-7
Coupler x 150# ASA flange.....	A-7
Coupler x TTMA flange	A-7
Dust plugs	A-7
Adapter tank unit x female NPT	A-8
Adapter tank unit x 150# flange	A-8
Adapter tank unit x TTMA flange.....	A-8
Dust caps	A-8
Steam coupler x female NPT	A-9
Steam adapter x female NPT.....	A-9
Dry gas couplings.....	A-10
Coupler hose unit x female NPT	A-10
Dust plugs	A-10
Adapter tank unit x female NPT	A-10
Adapter tank unit x female ACME	A-10
Adapter tank unit x 150# ASA flange	A-10
Dust caps	A-10
Dry aviation couplings	A-11 to A-12
Coupler x female NPT.....	A-11
Coupler x female BSP.....	A-11
Dust plug.....	A-11
Adapter x female NPT.....	A-12
Adapter x 150# ASA flange.....	A-12
Dust cap.....	A-12

Safety Break-aways A-13 to A-14

Marine series.....	A-13
Female NPT coupling	A-13
Male NPT coupling.....	A-13
150# flange	A-13
Industrial series	A-14
Female NPT coupling	A-14

Safety Break-aways (cont.) A-13 to A-14

Male NPT coupling.....	A-14
150# flange coupling.....	A-14
TTMA flanged.....	A-14

FloMAX Refueling..... A-15 to A-23

Diesel series	A-15 to A-17
Nozzles	A-15
Receiver, one-piece body	A-15
Receiver, two-piece body.....	A-15
Non-interchange nozzles and receivers.....	A-16
2" nozzles and receivers.....	A-16
Gravity fill receivers.....	A-17
Fuel vents	A-17
Fuel swivels	A-17
Service box	A-17
Standard series	A-18 to A-19
Engine oil nozzles and receivers	A-18
Coolant fluid nozzles and receivers	A-18
Hydraulic oil nozzles and receivers.....	A-19
Transmission nozzles and receivers.....	A-19
R series	A-20 to A-21
Engine oil nozzles and receivers	A-20
Coolant fluid nozzles and receivers	A-20
Hydraulic oil nozzles and receivers.....	A-21
Transmission fluid nozzles and receivers	A-21
High flow series	A-22
¾" nozzles	A-22
1" nozzles and receivers.....	A-22
Part number cross reference	A-23

Tank Truck Fittings..... A-24 to A-42

API.....	A-24 to A-27
API couplers	A-24
With bonded nose seal	A-24
With replaceable nose seal.....	A-24
Locking handle repair kit.....	A-24
API valves.....	A-24
Load only	A-24
Load / unload	A-24
API drop adapters.....	A-25
With sight glass.....	A-25
Gravity drop adapters	A-25
Repair kits.....	A-25
API Dust caps.....	A-25
Gravity drop adapter dust caps.....	A-26
Dixon Bayco adapters and couplers with grounding tab	A-26
API compatible rack cords.....	A-27
Optic assemblies.....	A-26
Thermistor assemblies.....	A-27
Replacement parts.....	A-27



Tank Truck Fittings (cont.) A-24 to A-42	Tank Truck Fittings (cont.) A-24 to A-42
Dixon® vapor recovery couplers A-28 to A-29	Tight fill A-38
With probe x adapter A-28	Elbows, complete unit A-38
With probe x coupler with probe A-28	Elbow coupler body A-38
Coupler x hose shank A-28	Male adapter inlet end A-38
Coupler x 45° hose shank A-29	Side seal A-38
With probe coupler x female NPT A-29	Drop elbow A-38
TTMA A-30 to A-33	Side seal to top seal adapter A-38
Flanged tee A-30	Dust caps and plugs with pull handle A-39
Flanged adapters A-30	Reelcraft® static discharge reel A-39
Flange x male NPT A-30	TFA series fill pipe adapter A-40
Flange x extended length male NPT A-30	Fuel delivery tank adapters A-40
Flange x female NPT A-30	Vapor recovery tank adapters A-40
Slip-on socket weld flange A-30	Caps A-41 to A-42
Buttweld flange A-30	Vapor caps A-41
Flange extension with port A-31	Automatic pressure / vacuum relief caps A-41
Flange extensions A-31	Standard stationary vent caps A-42
Cam and groove A-31	Fuel delivery adapter cap A-42
Adapter x TTMA flange A-31	Swivels A-43 to A-47
Coupler x TTMA flange A-31	Swivel joints A-43
22½° adapter x TTMA flange A-31	Single plane style A-44
22½° coupler x TTMA flange A-31	Double plane style A-44, A-45
Flange gaskets A-32	Triple plane style A-45
Sight Flow Indicators A-32 to A-33	Ordering Information A-46
TTMA flanged short sight flow indicators A-32	Loading arm A-47
TTMA flanged sight flow indicators A-32 to A-33	Split flange A-47
Repair kits A-33	Railroad tank car connections ... A-48 to A-51
Flange screen A-33	Style A A-48
Tank Transport Equipment A-34 to A-35	Style F A-48
Fusible pipe caps A-34	Style GF A-48
Pipe caps A-34	Style S A-48
Reducers A-34	Style T A-49
Reducing cap A-34	Dixon® coupler x tank car thread A-49
Coupling gaskets A-34	EZ Boss-Lock™ x coupler tank car thread A-49
Pipe caps A-35	Railroad unloading assemblies A-50
Thread adapters A-35	Dixon® tank car adapters A-50
Cam and groove adapter A-35	Cam and groove railroad tank car gaskets A-51
6200 series side lever type drop elbows A-36	Pin lug wrench A-51
6500 series self-locking drop elbows A-36	Threaded Pipe Fittings A-52
Inlets A-36	Sight flow indicators A-52
Male adapter A-36	
Female coupler A-36	
Female NPT A-36	
Dual point vapor recovery elbows, ball lever A-37	
Adapter inlet A-37	
Single point coaxial drop elbow A-37	
Adapter fuel inlets A-37	
Coupler fuel inlets A-37	

Bayloc™ Dry Disconnect Coupler x Female NPT

Features:

- automatic closing poppet assembly
- must be used with a DBA style adapter for coupler to operate, sold separately
- fully interchangeable with Kamvalok (OPW trademark) fittings
- maximum operating pressure at 70°F (21°C):
 - 1½" - 210 PSI
 - 2" - 150 PSI
 - 3" - 120 PSI
- aluminum fittings have stainless internals equivalent to 304 stainless



- stainless handle allows exposure to corrosive chemicals or wash down service
- heavy duty handle attachment prevents bending of crank assembly
- one piece stainless crank and link provide long service life
- EZ Boss-Lock™ cam arms, standard on all 1½" and 2" fittings, provide high security from accidental opening due to vibration or snagging
- large paddle type locking cam arms, standard on 3" fittings, allow for an easy grip



coupler x 1½" or 2" female NPT



coupler x 3" female NPT

Female NPT	Coupler Size	Seal Material	Maximum PSI at 70°F (21°C)	Aluminum		Stainless Steel ¹	
				Part #	Price/E	Part #	Price/E
1½"	2"	Buna	210	DBC61-150	\$753.40	DBC71-150	\$1668.00
2"	2½"		150	DBC61-200	792.55	DBC71-200	1855.75
3"	4"		120	DBC61-300	1650.70	DBC71-300	3983.20
1½"	2"	FKM	210	DBC62-150	816.85	DBC72-150	1731.90
2"	2½"		150	DBC62-200	887.90	DBC72-200	1951.65
3"	4"		120	DBC62-300	1842.45	DBC72-300	4194.95
1½"	2"	PTFE Encapsulated Silicone & FFPM	210	DBC63-150	1853.75	DBC73-150	2427.10
2"	2½"		150	DBC63-200	2124.15	DBC73-200	2838.60
3"	4"		120	DBC63-300	3413.85	DBC73-300	5627.20
1½"	2"	EPDM	210	DBC64-150	1174.65	DBC74-150	1731.90
2"	2½"		150	DBC64-200	1303.75	DBC74-200	1951.65
3"	4"		120	DBC64-300	2115.95	DBC74-300	4194.95
1½"	2"	FFPM and PTFE ²	210	---	---	DBC76-150	5193.75
2"	2½"		150	DBC66-200	4888.10	DBC76-200	5633.25
3"	4"		120	DBC66-300	8060.25	DBC76-300	11649.90
1½"	2"	PTFE Encapsulated FKM & FFPM	210	---	---	DBC77-150	2486.25
2"	2½"		150	---	---	DBC77-200	2455.65
3"	4"		120	---	---	DBC77-300	5215.75
3"	4"	FKM-B	120	DBC69-300	2223.30	DBC79-300	4592.50

Bayloc™ Dry Disconnect Greaseless Coupler x Female NPT



Female NPT	Coupler Size	Seal Material	Stainless Steel ¹	
			Part #	Price/E
1½"	2"	PTFE Encapsulated FKM & FFPM	DBC77-150-GL	\$2764.70
2"	2½"		DBC77-200-GL	2950.45

¹ stainless steel corrosion resistance is equivalent to 304 stainless steel

² FFPM gasket, main seal O-ring and handle O-ring, PTFE seals on cylinder assembly, stuffing box, and seal under poppet screw

Bayloc™ Dry Disconnect Coupler x 90° Swivel Female NPT



Female NPT	Coupler Size	Seal Material	Aluminum	
			Part #	Price/E
2"	2½"	Buna FKM	DBS61-200	\$960.85
2"	2½"		DBS62-200	1108.30
2"	2½"	PTFE Encapsulated Silicone & FFPM	DBS63-200	2251.45

Bayloc™ Dry Disconnect Coupler Locking Kit



Description	Aluminum	
	Part #	Price/E
for use with 1½" and 2" dry disconnect couplers	DBCL-200	\$106.70
for use with 3" dry disconnect couplers	DBCL-300	106.70

Note: Reference page D-59 for dust plugs for couplers.

Bayloc™ Dry Disconnect Adapter x Female NPT

Applications:

- compatible with most cam and groove style dry disconnects
- helps prevent spillage from normal or accidental disconnects
- spring loaded sealing device snaps closed should valve become disconnected with the poppet open

Features:

- two-piece adapter design for easy rebuilding of adapters
- fully interchangeable with Kamvalok (OPW trademark) style fittings
- for pressure ratings at other temperatures, contact Dixon®
- contact Dixon® at 800.355.1991 for chemical compatibility, size, material selection and special configurations

Female NPT	Adapter Size	Seal Material	Maximum PSI at 70°F (21°C)	Aluminum		Stainless Steel	
				Part #	Price/E	Part #	Price/E
1½"	2"	Buna	210	DBA11-150	\$205.70	DBA71-150	\$500.90
2"	2½"		150	DBA11-200	222.95	DBA71-200	573.85
3"	4"		120	DBA11-300	435.55	DBA71-300	1284.45
1½"	2"	FKM	210	DBA12-150	210.10	DBA72-150	500.90
2"	2½"		150	DBA12-200	229.40	DBA72-200	643.75
3"	4"		120	DBA12-300	449.45	DBA72-300	1302.45
1½"	2"	PTFE Encapsulated Silicone	210	DBA63-150	276.85	DBA73-150	506.35
2"	2½"		150	DBA63-200	319.60	DBA73-200	648.15
3"	4"		120	DBA63-300	479.45	DBA73-300	1510.20
1½"	2"	EPDM	210	DBA64-150	255.70	DBA74-150	519.40
2"	2½"		150	DBA64-200	291.70	DBA74-200	573.85
3"	4"		120	DBA64-300	559.30	DBA74-300	1416.25
1½"	2"	FFPM	210	DBA66-150	878.90	DBA76-150	1174.60
2"	2½"		150	DBA66-200	1084.05	DBA76-200	1298.45
3"	4"		120	DBA66-300	1877.70	DBA76-300	2876.40
1½"	2"	PTFE Encapsulated FKM	210	---	---	DBA77-150	557.35
2"	2½"		150	---	---	DBA77-200	679.20
3"	4"		120	---	---	DBA77-300	1376.35
3"	4"	FKM-B	120	DBA69-300	687.20	---	---



adapter x 1½" and 2" female NPT



adapter x 3" female NPT

Bayloc™ Dry Disconnect Jump Size Adapter x Female NPT

Female NPT	Adapter Size	Seal Material	Maximum PSI at 70°F (21°C)	Aluminum	
				Part #	Price/E
2"	2"	Buna	150	DBA11-1520	\$214.75
2"	2"	FKM	150	DBA12-1520	224.15



Bayloc™ Dry Disconnect Adapter x 150# ASA Flange

Female NPT	Adapter Size	Seal Material	Maximum PSI at 70°F (21°C)	Stainless Steel	
				Part #	Price/E
2"	2"	FKM	150	DBAF72-1520	\$1172.35
		PTFE Encapsulated Silicone		DBAF73-1520	1184.00
		EPDM		DBAF74-1520	1184.00
		FFPM		DBAF76-1520	1717.55
2"	2½"	FKM	150	DBAF72-200	1210.85
		PTFE Encapsulated Silicone		DBAF73-200	1221.10
		EPDM		DBAF74-200	1221.10
		FFPM		DBAF76-200	1928.50
3"	4"	FKM	150	DBAF72-300	1928.60
		PTFE Encapsulated Silicone		DBAF73-300	2010.15
		EPDM		DBAF74-300	2010.15
		FFPM		DBAF76-300	3175.10



Note: Reference page D-59 for dust caps for adapters

- For flange dimensions, diagrams and additional information please reference dixonvalve.com.

Bayloc™ Dry Disconnect Vapor Adapter x Female NPSM



Female NPSM	Adapter Size	Seal	Max PSI at 70°F (21°C)	Stainless Steel ¹	
				Part #	Price/E
1½"	2"	PTFE	150	DBAV73-2030	\$685.45

¹ stainless steel corrosion resistance is equivalent to 304 stainless steel

Note: Reference page D-59 for dust caps for adapters

Cam & Groove Actuator Style Couplers

Applications:

- suited for vapor recovery, suction pump line and other applications where it is necessary to easily drain the hose or pipe for cleaning
- can also be used when product retention in a hose or pipe is desired and damage from accidental spill from an open coupler is not a concern
- couplers work with the DBA popped adapters on page A-3 in applications where automatic closure for the coupler is not desired

Features:

- EZ Boss-Lock™ cam arms
- stainless steel locking lever standard
- use with standard cam and groove dust plugs sized one size larger than the dry disconnect size
- prevents spillage from normal and accidental disconnection of the connection

Materials:

- 316 stainless steel body
- 304 stainless steel internal components
- replacement parts are available, contact Dixon® for more information



Female NPT	Coupler Size	Seal Material	Stainless Steel	
			Part #	Price/E
1½"	2"	<i>Buna</i>	D2C71-150	\$1030.85
2"	2½"		D2C71-200	1135.10
1½"	2"	<i>FKM</i>	D2C72-150	1051.40
2"	2½"		D2C72-200	1156.90
1½"	2"	<i>PTFE Encapsulated Silicone</i>	D2C73-150	1272.75
2"	2½"		D2C73-200	1347.35
1½"	2"	<i>EPDM</i>	D2C74-150	1030.85
2"	2½"		D2C74-200	1135.10
1½"	2"	<i>PTFE Encapsulated FKM</i>	D2C77-150	1272.75
2"	2½"		D2C77-200	1347.35
1½"	2"	<i>FKM-B</i>	D2C79-150	1102.90
2"	2½"		D2C79-200	1214.60

Application:

- for the spill-less transfer of petroleum products such as fuel oil, lube oil blending and tank truck delivery

Feature:

- ensures a spill free connection, fluid cannot flow until couplings are connected together and valve is opened; coupling can then not be disconnected until the valve handle is closed
- maximum operating pressure: **85 PSI @ 70°F (21°C)**, for pressure ratings at other temperatures contact Dixon®
- replacement parts available, contact Dixon® for more information

Bayonet Style Dry Disconnect 90° Swivel Coupler x Female NPT

Size	Seal Material	Anodized Aluminum	
		Part #	Price/E
2"	Buna	BS61-200	\$864.95
2"	FKM	BS62-200	932.90
3"	Buna	BS61-300	1478.20
3"	FKM	BS62-300	1596.10



Bayonet Style Dry Disconnect Straight Coupler x Female NPT

Size	Seal Material	Anodized Aluminum	
		Part #	Price/E
2"	Buna	BC61-200	\$687.20
2"	FKM	BC62-200	749.15



Bayonet Style Dry Disconnect Straight Swivel Coupler x Female NPT

Size	Seal Material	Anodized Aluminum	
		Part #	Price/E
2"	Buna	BSS61-200	\$864.95
2"	FKM	BSS62-200	932.90
3"	Buna	BSS61-300	1396.35
3"	FKM	BSS62-300	1516.20



Bayonet Style Dust Plugs

Size	Rubber with Stainless Steel Chain	
	Part #	Price/E
2"	BCP-200	\$64.55
3"	BCP-300	73.45



Bayonet Style Dry Disconnect Adapter x Female NPT

Size	Seal Material	Stainless Steel		Brass		Aluminum	
		Part #	Price/E	Part #	Price/E	Part #	Price/E
2"	Buna	BA31-200	\$215.75	---	---	---	---
2"	FKM	BA32-200	215.75	---	---	---	---
3"	Buna	---	---	BA31-300	\$523.35	BA61-300	\$479.45
3"	FKM	---	---	BA32-300	523.35	BA62-300	479.45



Bayonet Style Dust Caps

Size	Rubber with Stainless Steel Chain	
	Part #	Price/E
2"	BAC-200	\$50.95
3"	BAC-300	56.65



Mann Tek Dry Disconnect Couplings

Applications:

- used by producers of ink, adhesives, fatty acids, pharmaceuticals, liquid soaps, petroleum, chemicals, agricultural and a wide variety of common caustic and specialty acids
- designed for the quick and spill free connection and disconnection of hoses and pipelines

Features:

- easy to handle - push and turn - free flow, turn and pull - closed
- time saving - no need to drain hoses or pipe systems
- economical - no loss or spillage of liquids at connection or disconnection
- safety - the valve cannot be opened until the unit is coupled
- environmental friendly - accidental spillage eliminated when proper used
- safe and reliable - due to rugged construction
- product life - uncomplicated design and high quality materials ensures long product life
- selectivity - To avoid product contamination, selective versions of the couplers and adapters are available. Contact Dixon® for further information.
- produced according to NATO standard STANAG 3756 and ATOFINA SGM 2049.TUY.C.
- working pressure at ambient temperature **70°F (21°C)**:
 - aluminum: **230 PSI**, up to 4"
 - brass/ gunmetal ¹: **230 PSI**, up to 4"
 - stainless steel: **360 PSI**
- standard seal supplied: FKM
- optional seals:
 - EPDM
 - NBR - nitrile
 - Kalrez®
 - Chemraz®
- seal kits are available
- interchanges with Avery Hardoll and Todo-matic®

¹ produced to US government bronze specification G



How it Works

The principle of operation is identical for all sizes of couplings.

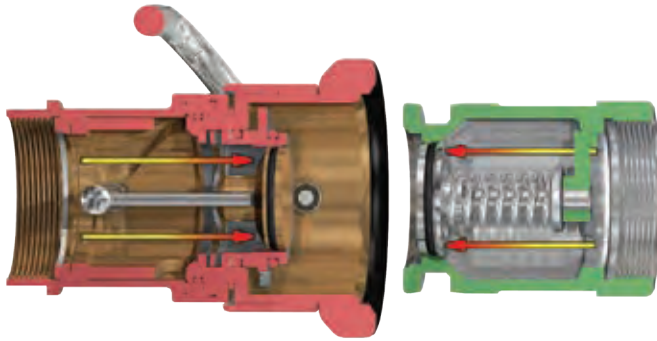

Closed:

- Turn and pull
it's released - no spillage

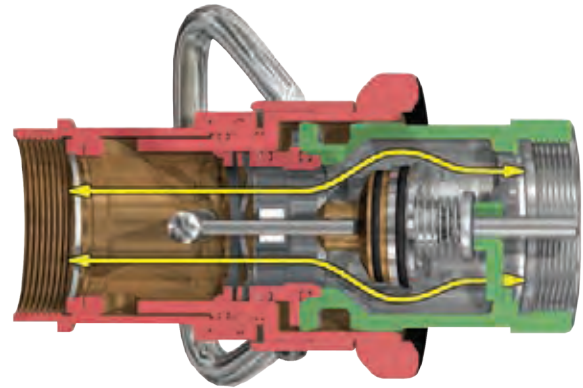

Open:

- Push and turn
it's coupled - full flow

Mann Tek Dry Disconnect Couplers - Hose Unit

Features:

- coupler has built-in swivel
- stainless steel ball bearings
- stainless steel shaft journal embedded in PTFE to eliminate seizure
- riveted piston pin to minimize the risk for failure under extreme pressure conditions
- the protective ring is a specially formulated, weather resistant and electrically conductive rubber compound
- all wetted parts are stainless steel
- stainless steel couplers: rollers are Hastelloy C276 on the stainless steel shaft
- aluminum and brass couplers: rollers are aluminum-bronze on the stainless steel shaft
- composite (Polyeten PE-HD 300) plugs provide good protection against corrosion and withstand hot and cold environments

Coupler - Hose Unit x Female NPT



Female NPT	Body Size	316 Stainless Steel		Aluminum		Brass / Gunmetal ¹	
		Part #	Price/E	Part #	Price/E	Part #	Price/E
3/4"	56 mm	DDC075SS	\$1764.45	DDC075AL	\$934.65	DDC075BR	\$1311.40
1"	56 mm	DDC100SS	1764.45	DDC100AL	934.65	DDC100BR	1311.40
1 1/2"	70 mm	DDC150SS	2710.30	DDC150AL	1355.15	DDC150BR	1627.95
2"	70 mm	DDC200SS	2775.55	DDC200AL	1355.15	DDC200BR	1627.95
3"	105 mm	DDC300SS105	4698.55	DDC300AL105	1518.95	DDC300GM105	2154.50
3"	119 mm	DDC300SS	4721.95	DDC300AL	1552.40	DDC300GM	2404.90
4"	164 mm	DDC400SS	8137.20	DDC400AL	3220.15	DDC400GM	4372.35
6"	238 mm	DDC600SS	22275.20	DDC600AL	11312.40	---	---

¹ produced to US government bronze specification G

Coupler - Hose Unit x 150# ASA Flange

150# Flange	Body Size	316 Stainless Steel	
		Part #	Price/E
2"	70 mm	DDC200SSFL	\$4237.50
3"	119 mm	DDC300SSFL	6569.60
4"	164 mm	DDC400SSFL	10351.30
6"	238 mm	DDC600SSFL	21214.50
8"	272 mm	DDC800SSFL	78697.45



- For flange dimensions, diagrams and additional information please reference dixonvalve.com.

Coupler - Hose Unit x TTMA Flange

TTMA Flange	Body Size	Aluminum	
		Part #	Price/E
4"	164 mm	DDC400AL164TTMA	\$4324.30



- For flange dimensions, diagrams and additional information please reference dixonvalve.com.

Dust Plugs for Coupler - Hose Unit

Size	Body Size	Polyeten PE-HD 300	
		Part #	Price/E
3/4" and 1"	56 mm	DDDP075	\$87.90
1 1/2" and 2"	70 mm	DDDP150	91.15
3"	105 mm	DDDP300105	94.10
3"	119 mm	DDDP300	94.10
4"	164 mm	DDDP400	188.45
6"	238 mm	DDDP600 ¹	504.20



¹ 6" is aluminum

Mann Tek Dry Disconnect Adapters - Tank Unit

Application:

- usually installed on the tank or manifold

Features:

- conical valve seat reduces the risk for piston blow out
- PTFE bearing between piston shaft and guide eliminates risk of seizure
- aluminum adapter: aluminum poppet, stainless steel internal parts
- stainless steel adapter: stainless steel poppet, stainless steel internal parts
- brass / gunmetal ¹ adapter: brass poppet, brass and stainless steel internal parts
- composite (Polyeten PE-HD 300) cap to provide good protection in harsh environments
- FKM (FPM) gaskets standard on polyeten caps

Adapter-Tank Unit x Female NPT



Female NPT	Body Size	316 Stainless Steel		Aluminum		Brass / Gunmetal ¹	
		Part #	Price/E	Part #	Price/E	Part #	Price/E
¾"	56 mm	DDA075SS	\$642.35	DDA075AL	\$469.65	DDA075BR	\$534.25
1"	56 mm	DDA100SS	642.35	DDA100AL	469.65	DDA100BR	534.25
1½"	70 mm	DDA150SS	950.25	DDA150AL	472.25	DDA150BR	544.30
2"	70 mm	DDA200SS	950.25	DDA200AL	472.25	DDA200BR	544.30
3"	105 mm	DDA300SS105	1314.55	DDA300AL105	562.90	DDA300GM105	733.45
3"	119 mm	DDA300SS	1283.70	DDA300AL	580.60	DDA300GM	764.40
4"	164 mm	DDA400SS	2359.85	DDA400AL	1042.85	DDA400GM	1587.70
6"	238 mm	DDA600SS	8745.50	DDA600AL	4332.95	---	---

Adapter-Tank Unit x 150# ASA Flange



150# Flange	Body Size	316 Stainless Steel		Aluminum		Brass / Gunmetal ¹	
		Part #	Price/E	Part #	Price/E	Part #	Price/E
¾"	56 mm	DDA075SSFL	\$1195.45	---	---	---	---
1"	56 mm	DDA100SSFL	1195.45	DDA100ALFL	\$836.25	DDA100BRFL	\$949.00
1½"	70 mm	DDA150SSFL	1257.25	DDA150ALFL	694.10	DDA150BRFL	957.55
2"	70 mm	DDA200SSFL	1257.25	DDA200ALFL	694.10	DDA200BRFL	957.55
3"	105 mm	DDA300SS105FL	1422.05	DDA300AL105FL	792.15	DDA300GM105FL	1051.25
3"	119 mm	DDA300SSFL	1754.80	DDA300ALFL	873.35	DDA300GMFL	1126.50
4"	164 mm	DDA400SSFL	2860.70	DDA400ALFL	1228.60	DDA400GMFL	2000.55
6"	238 mm	DDA600SSFL	9244.10	DDA600ALFL	4761.30	---	---
8"	272 mm	DDA800SSFL	33726.90	---	---	---	---

¹ produced to US government bronze specification G

- For flange dimensions, diagrams and additional information please reference dixonvalve.com.

Adapter-Tank Unit x TTMA Flange



TTMA Flange	Body Size	Aluminum	
		Part #	Price/E
3"	105 mm	DDA300AL105TTMA	\$792.15
3"	119 mm	DDA300AL119TTMA	873.35
4"	164 mm	DDA400AL164TTMA	1228.60

- For flange dimensions, diagrams and additional information please reference dixonvalve.com.

Dust Caps for Adapter-Tank Unit



Size	Body Size	Polyeten PE-HD 300	
		Part #	Price/E
¾" and 1"	56 mm	DDDC075	\$142.55
1½" and 2"	70 mm	DDDC150	156.10
3"	105 mm	DDDC300105	172.30
3"	119 mm	DDDC300	191.65
4"	164 mm	DDDC400	360.35
6"	238 mm	DDDC600 ¹	1338.05

¹ 6" dust cap is aluminum

Note: Reference page A-10 for rubber dust caps.



Mann Tek Dry Disconnects for Steam Service

Applications:

- designed to fit hoses carrying steam used in chemical (heating), pharmaceutical (disinfection and sterilization) and at loading bays

Features:

- coupling housing and all inner parts: stainless steel
- EPDM 291 seal
- unintentional separation is eliminated preventing accidents and avoiding unintended down time
- performance unaffected by surface rust
- lockable versions are available on 1½" and 2", contact Dixon®
- couplers supplied with double handles
- **150 PSI at 350°F (177°C)**

Coupler - Hose Unit x Female NPT

Female NPT	Body Size	316 Stainless Steel	
		Part #	Price/E
¾"	56 mm	DDSC075SS	\$2423.05
1"	56 mm	DDSC100SS	2423.05
1½"	70 mm	DDSC150SS	2833.35
2"	70 mm	DDSC200SS	2833.35



Adapter - Tank Unit x Female NPT

Female NPT	Body Size	316 Stainless Steel	
		Part #	Price/E
¾"	56 mm	DDSA075SS	\$745.50
1"	56 mm	DDSA100SS	745.50
1½"	70 mm	DDSA150SS	982.20
2"	70 mm	DDSA200SS	982.20





Mann Tek Dry Gas Couplings

Applications:

- primary application is in the handling of LPG - Propane and Butane
- designed for loading and discharge of bobtails or intermediate bulk delivery trucks to and from rail cars

Features:

- reliable, easy to maintain
- can be coupled to a tank unit with pressures up to **225 PSI** at ambient temperature **70°F (21°C)**, if pressure is higher, equip couplings with pressure relief valves.
- minimizes the risk of cold burns, spillage, product loss and health risks and keeps the environment free of hazardous vapors and liquids
- compatible with existing dry disconnect couplings
- stainless steel and brass / gunmetal (*produced to US government bronze specification G*)
- FKM (FPM) seals
- working pressure: **360 PSI** at ambient temperature **70°F (21°C)**
- composite (Polyeten PE-HD 300) plug provides good protection in harsh environments
- for pressure relief options contact Dixon®

Coupler-Hose Unit x Female NPT



Female NPT	Body Size	316 Stainless Steel	
		Part #	Price/E
1"	56 mm	DGC100SS	\$2238.20
2"	71 mm	DGC200SS	3370.90
3"	119 mm	DGC300SS	4751.90

Dust Plug for Dry Gas Adapter



Size	Body Size	Polyeten PE-HD 300	
		Part #	Price/E
1"	56 mm	DGDP100	\$91.35
2"	71 mm	DGDP200	91.35
3"	119 mm	DGDP300	91.35

Adapter-Tank Unit x Female NPT



Female NPT	Body Size	316 Stainless Steel	
		Part #	Price/E
1"	56 mm	DGA100SS	\$803.90
2"	71 mm	DGA200SS	1045.95
3"	119 mm	DGA300SS	1193.00

Adapter-Tank Unit x Female ACME



Female ACME	Body Size	316 Stainless Steel	
		Part #	Price/E
1¾"	56 mm	DGA100SS175	\$2305.45
3¼"	71 mm	DGA200SS325	1806.00

Adapter-Tank Unit x 150# ASA Flange



150# Flange	Body Size	316 Stainless Steel	
		Part #	Price/E
1"	56 mm	DGA100SSFL	\$1316.45
2"	71 mm	DGA200SSFL	1401.35
3"	119 mm	DGA300SSFL	1664.30

- For flange dimensions, diagrams and additional information please reference dixonvalve.com.

Dust Cap for Dry Gas Coupler



Size	Body Size	Material	Part #	Price/E
1"	56 mm	<i>polyeten PE-HD300</i>	DGDC100	\$147.50
2"	71 mm	<i>rubber</i>	DGDC200	81.80
3"	119 mm	<i>rubber</i>	DGDC300	94.15

Mann Tek Dry Aviation Couplers - Hose Unit

Application:

- designed for use in aviation refueling systems

Features:

- working pressure: **150 PSI** at ambient temperature **70°F (21°C)**
- composite (Polyeten PE-HD 300) plug provides good protection in harsh environments
- accepts international standard 2½" point bayonet, hose end refueling nozzles according to: ISO45 / MS24484 / STANAG 3105 / British Aerospace Spec. 2C14, **they are not configured for under-wing refueling** 
- gunmetal coupling ring minimizes the risk of seizure
- riveted piston pin minimizes risk of failure under extreme pressure conditions
- protective ring is a specially formulated, weather resistant and electrically conductive rubber compound

Materials:

- body: high strength aluminum
- coupling ring: gunmetal (*produced to U.S. government bronze specification G*)
- bayonet flange and inner parts: stainless steel, aluminum
- all wetted parts are aluminum and stainless steel
- stainless steel ball bearings
- stainless steel shaft journal embedded in PTFE eliminates seizure
- PTFE bearings between the driving plate and piston guide eliminate the risk of seizure

Coupler-Hose Unit x Female NPT

Female NPT	Body Size	Aluminum	
		Part #	Price/E
2½"	ISO 45	DAC250AL	\$1786.30
3"	ISO 45	DAC300AL	1786.30

Coupler-Hose Unit x Female BSP

Female BSP	Body Size	Aluminum	
		Part #	Price/E
2½"	ISO 45	DAC250ALBSP	\$1786.30
3"	ISO 45	DAC300ALBSP	1786.30



Dust Plug for Dry Aviation Coupler

Size	Body Size	Aluminum	
		Part #	Price/E
2½"	ISO 45	DADP250	\$220.45



Mann Tek Dry Aviation Adapters - Tank Unit

Application:

- designed for use in aviation refueling systems

Features:

- working pressure: **150 PSI** at ambient temperature **70°F (21°C)**
- composite (Polyeten PE-HD 300) cap provides good protection in harsh environments
- accepts international standard 2½" point bayonet hose end refueling nozzles according to: ISO45 / MS24484 / STANAG 3105 / British Aerospace Spec. 2C14, **not configured for under-wing refueling** 
- gunmetal coupling ring minimizes the risk of seizure
- PTFE bearings between the piston shaft and the piston guide eliminate the risk of seizure
- conical valve seat eliminates the risk of piston blow out when extreme pressure is used

Materials:

- body: high strength aluminum
- coupling ring: gunmetal
- bayonet flange and inner parts: stainless steel, aluminum
- all wetted parts are in aluminum and stainless steel

Adapter-Tank Unit x Female NPT



Size	Body Size	Aluminum	
		Part #	Price/E
2½"	ISO 45	DAA250AL	\$1027.65
3"	ISO 45	DAA300AL	1027.65

Adapter-Tank Unit x 150# ASA Flange



150# Flange	Body Size	Aluminum	
		Part #	Price/E
2½"	ISO 45	DAA250ALFL	\$1191.00
3"	ISO 45	DAA300ALFL	1189.85

- For flange dimensions, diagrams and additional information please reference dixonvalve.com.

Dust Cap for Dry Aviation Adapter



Size	Body Size	Polyeten PE-HD 300	
		Part #	Price/E
2½"	ISO 45	DADC250	\$151.10

Mann Tek Safety Break-away Coupling - Marine Version

Application:

- typically for ship-to-offshore platform and ship-to-ship product transfer operations

Features:

- **designed to be installed within a hose string where the coupling will have a length of hose attached to both sides**
- minimizes spillage and damage associated with pull-away incidents
- coupling automatically senses excessive load, closes the valves and disconnects, release is executed when force causes bolts to break
- working pressure: **360 PSI** at ambient temperature **70°F (21°C)**
- FKM (FPM) O-rings
- optional non-closure design available, contact Dixon®



Female NPT x Female NPT

Size	DN Size	316 Stainless Steel	
		Part #	Price/E
2"	50	MSBC200SS	\$3210.70
3"	80	MSBC300SS	5680.95
4"	100	MSBC400SS	9110.75
5"	125	MSBC500SS	17259.20



Male NPT x Male NPT

Size	DN Size	316 Stainless Steel	
		Part #	Price/E
2"	50	MSBC200SSMNPT	\$3331.30
3"	80	MSBC300SSMNPT	5926.65
4"	100	MSBC400SSMNPT	9725.50
5"	125	MSBC500SSMNPT	16233.15
6"	150	MSBC600SSMNPT	32438.60



150# Flange x 150 Flange

Size	DN Size	316 Stainless Steel	
		Part #	Price/E
2"	50	MSBC200SSFL	\$4923.95
3"	80	MSBC300SSFL	7895.55
4"	100	MSBC400SSFL	11325.30
5"	125	MSBC500SSFL	19382.40
6"	150	MSBC600SSFL	30838.40
8"	200	MSBC800SSFL	63601.75



- For flange dimensions, diagrams and additional information please reference dixonvalve.com.

How it Works

Safety break-away couplings have three external break bolts. In the case of axial tension all of the bolts take up the force corresponding to the break force on the hose with a safety margin. Non-axial forces concentrate the tension forces more strongly on one bolt, so that the safety break-away coupling reacts in a natural way to the reduction of the hose break forces.



BEFORE emergency disconnect

The safety break-away valve consists of two halves, each with a valve that has a O-ring seal.

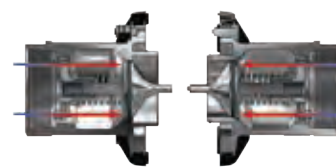

AFTER emergency disconnect

When the safety break-away couplings separate, it allows the valves to close. The two valves close rapidly, minimizing exposure to personnel and the environment.

Mann Tek Safety Break-away Coupling - Industrial Version

Application:

- loading rack, bulk loading / unloading, road tankers and rail tankers

**Features:**

- designed to be installed between a fixed point (pipe, pump, manifold) and a hose
- minimizes spillage and damage associated with pull-away incidents
- coupling automatically senses excessive load, closes valves and disconnects, release is executed when force causes bolts to break
- high flow rate / low pressure drop
- working pressure: stainless steel **360 PSI** and aluminum **230 PSI** at ambient temperature **70°F (21°C)**
- FKM (FPM) seal standard
- optional non-closure design available, contact Dixon®

Female NPT x Female NPT



Size	DN Size	316 Stainless Steel		Aluminum	
		Part #	Price/E	Part #	Price/E
2"	50	SBC200SS	\$2675.55	SBC200AL	\$1380.15
3"	80	SBC300SS	5043.20	SBC300AL	2594.85
4"	100	SBC400SS	7592.25	SBC400AL	3971.85
5"	125	SBC500SS	13527.15	SBC500AL	8602.95
6"	150	SBC600SS	24469.95	SBC600AL	19209.55

Male NPT x Male NPT



Size	DN Size	316 Stainless Steel		Aluminum	
		Part #	Price/E	Part #	Price/E
2"	50	SBC200SSMNPT	\$2797.30	SBC200ALMNPT	\$1510.20
3"	80	SBC300SSMNPT	4980.35	SBC300ALMNPT	2760.25
4"	100	SBC400SSMNPT	8206.55	SBC400ALMNPT	4137.45
5"	125	SBC500SSMNPT	13527.15	SBC500ALMNPT	8602.95
6"	150	SBC600SSMNPT	28993.75	SBC600ALMNPT	20521.70

150# Flange x 150# Flange



Size	DN Size	316 Stainless Steel		Aluminum	
		Part #	Price/E	Part #	Price/E
2"	50	SBC200SSFL	\$4103.25	SBC200ALFL	\$2364.25
3"	80	SBC300SSFL	6579.60	SBC300ALFL	3460.65
4"	100	SBC400SSFL	9437.80	SBC400ALFL	4890.95
5"	125	SBC500SSFL	16854.05	SBC500ALFL	11139.50
6"	150	SBC600SSFL	25698.65	SBC600ALFL	20128.60
8"	200	SBC800SSFL	63601.75	---	---

- For flange dimensions, diagrams and additional information please reference dixonvalve.com.

Mann Tek TTMA Flanged Breakaway Coupling - Industrial Version

Features:

- minimizes spillage and damage associated with drive away and pull away incidents
- installs between an API coupler and loading arm
- coupling automatically senses excessive load, closes the valves and disconnects, release is executed when force causes the bolts to break
- high flow rate / low pressure drop
- 150 PSI** at ambient temperature **70°F (21°C)**
- FKM/FPM is standard seal



Size	Aluminum	
	Part #	Price/E
4"	SBC400ALTTMA	\$4890.95

- For flange dimensions, diagrams and additional information please reference dixonvalve.com.

FloMAX Diesel Fueling System

Application:

- designed for on-site refueling of construction, mining, forestry and agricultural equipment

Diesel Fuel Nozzles

Features:

- 1½" female NPT
- tested to 180 gallons per minute
- integrated high flow swivel and sealing plug
- plug/bumper assembly gives complete nose seal
- investment cast aluminum housing
- anodized aluminum non-wear parts
- stainless steel wear components
- Delron® bushings eliminate metal-to-metal wear
- interchanges with Caterpillar® and Wiggins systems



Description	Part #	Price/E
dog latch mechanism with sealing plug	FN600	\$2517.00
ball lock with sealing plug	FN600BL	2517.00
sealing plug for FN600	FN600B-PLUG	179.80
sealing plug for FN600BL	FN600B	179.80

One-Piece Diesel Fuel Receivers

Features:

- 2" male NPT
- O-ring sealed aluminum cap
- cap has set screw attached vinyl coated cable lanyard



Description	Material	Part #	Price/E
one-piece receiver without cap	<i>nickel-plated steel</i>	FRS	\$350.65
one-piece receiver with cap	<i>nickel-plated steel</i>	FRS-C	404.55
one-piece receiver without cap	<i>anodized aluminum</i>	FRA	350.65
one-piece receiver with cap	<i>anodized aluminum</i>	FRA-C	404.55
cap for receiver	<i>anodized aluminum</i>	FR-CAP	121.40

Two-Piece Diesel Fuel Receivers

Features:

- 2" male NPT
- O-ring sealed aluminum cap
- cap has set screw attached vinyl coated cable lanyard



Description	Part #	Price/E
two-piece receiver with removable stainless sleeve, without cap	FR-RS	\$602.30
two-piece receiver with removable stainless sleeve with cap	FR-RS-C	656.25
removable sleeve replacement for two-piece receiver	FR-RS-R	197.80
cap for receiver	FR-CAP	121.40



Non-Interchange Diesel Fuel Nozzle

Application:

- used in biodiesel fueling

Features:

- 1½" female NPT
- design prevents fuel contamination
- connects to the non-interchange receiver only
- ball lock design

Description	Part #	Price/E
ball lock fuel nozzle	<i>FN600BL-NI</i>	\$2891.25

Non-Interchange Diesel Fuel Receiver

Application:

- used in biodiesel fueling

Features:

- design prevents fuel contamination
- connects to the non-interchange nozzle only
- ball lock design



Description	Anodized Aluminum Part #	Price/E
one-piece receiver with cap	<i>FRA-NI-C</i>	\$464.55

2" High Volume Diesel Fueling System

Features:

- capable of flowing over 400 GPM
- 2" female NPT
- stainless steel ball lock design
- removable pull back assembly

Materials:

- housing: aluminum
- non-wear parts: anodized aluminum
- internal wear components: stainless steel
- bushings: Delron®

Diesel Fuel Nozzles



Description	Part #	Price/E
2" fuel nozzle	<i>FX1500</i> ¹	\$4483.35
2" fuel nozzle - with plug	<i>FX1500P</i> ¹	4636.15
2" fuel nozzle - with swivel	<i>FX1500S</i> ¹	4708.10
2" fuel nozzle - with swivel, with plug	<i>FX1500SP</i> ¹	4860.90
2" sealing plug for nozzle	<i>FX1500PLUG</i>	213.55

¹ must be used with high flow fuel vents found on page A-17

Diesel Fuel Receivers



Description	Part #	Price/E
2" diesel fuel receiver	<i>FRX</i>	\$672.00
2" fuel receiver with cap	<i>FRX-C</i>	784.35
2" cap for receiver	<i>FRXCAP</i>	157.35

Diesel Fuel Gravity Fill Receivers

Feature:

- used with the FN600 or FN600BL to convert to gravity fueling

Size	Description	Part #	Price/E
1 3/8"	straight	GFR-0	\$454.00
1 3/8"	45°	GFR-45	481.00
1 3/8"	90°	GFR-90	481.00
1"	straight	GFR1-0	481.00
1"	45°	GFR1-45	503.45
1"	90°	GFR1-90	503.45

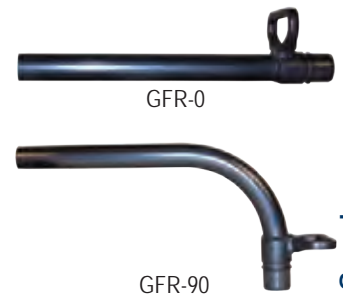

Engineered Fluid Transfer Couplings

Fuel Vents

Features:

- 2" male NPT
- billet cap provides superior impact resistance
- easily serviced all metal construction
- rigid ball cage for positive seal
- available with: threaded outlet, half coupling and anti-vandalism mounting

Description	Part #	Price/E
vent with 5" tube	VT	\$418.05
vent with 7" tube	VT7	431.55
vent with 9" tube	VT9	445.00
vent with 5" tube and threaded outlet	VTT	467.50



High Flow Fuel Vents

Feature:

- 7" tubes are available, contact Dixon® for more information

Description	Part #	Price/E
high flow fuel vent with 5" tube	VTX	\$777.60
high flow fuel vent with 9" tube	VTX-9	813.55



Diesel Fuel Swivels

Features:

- stainless steel male threaded base and ball bearings
- hard black anodized female threaded nut
- fluorosilicone sealing O-rings

Thread Size	Description	Part #	Price/E
1 1/2" male NPT x 1 1/2" female NPT	standard	FNS	\$323.65
2" male NPT x 1 1/2" female NPT	standard	FNS2	337.15
1 1/2" female NPT x 1 1/2" female NPT	double	FNSID	364.15
1 1/2" male NPS x 1 1/2" female NPT	standard	FN600S¹	323.65

¹ used with FN600 or FN600BL



Service Box

Features:

- Designed to enclose receivers for diesel fuel, hydraulic oil, transmission fluid and coolant reducing contamination and weather related problems.
- normally installed on heavy duty earth mover equipment and drill rigs
- 12 gauge steel construction with heavy duty hinges
- painted with Imron® Primer

Part #	Price/E
FSB	\$1719.95



receivers sold separately

Standard Series Connectors

Features:

- standard series connectors consist of four color-coded mating connectors
- all-metal construction with stainless steel wear components and anodized aircraft grade aluminum non-wear components
- easily recognizable labeling
- fully compatible and interchangeable with industry standards

Engine Oil Nozzles

Features:

- **bright red**
- universally fits both R-series and Standard series crankcase receivers
- incorporates 10 locking balls with a 40% deeper engagement
- resistant to clogging with a greater ease of cleaning
- smooth actuation
- larger diameter pullback lanyard



Male Thread	Description	Anodized Aluminum	
		Part #	Price/E
3/4" NPT	engine nozzle ball lock	ENBL	\$575.35
3/4" NPT	engine nozzle ball lock with plug	ENBL-P	629.30
---	engine nozzle plug	ENBL-PLUG	98.90

Engine Oil Receivers



ERS-C



ERJ-C

Male Thread	Description	Anodized Aluminum	
		Part #	Price/E
3/4" NPT	engine receiver	ERS	\$247.20
3/4" NPT	engine receiver with cap	ERS-C	305.65
---	engine receiver cap	ERS-CAP	98.90
3/4" JIC	engine receiver with JIC bulkhead base	ERJ	319.15
3/4" JIC	engine receiver with JIC bulkhead base and cap	ERJ-C	373.10

Coolant Fluid Nozzles

Features:

- **bright teal**
- standard roll-pin locking mechanism
- ergonomically engineered pullbacks and caps



Male Thread	Description	Anodized Aluminum	
		Part #	Price/E
1/2" NPT	coolant nozzle ball lock	CN	\$382.10
1/2" NPT	coolant nozzle ball lock with plug	CN-P	436.00
---	coolant nozzle plug	CN-PLUG	98.90

Coolant Fluid Receivers



Male Thread	Description	Anodized Aluminum	
		Part #	Price/E
1/2" NPT	coolant receiver	CR-S	\$220.30
1/2" NPT	coolant receiver with cap	CR-C	274.20
---	coolant receiver cap	CR-CAP	98.90

Hydraulic Oil Nozzles

Features:

- **bright gold**
- 10 steel dog latching mechanism
- ergonomically engineered pullbacks and caps

Female Thread	Description	Anodized Aluminum	
		Part #	Price/E
3/4" NPT	hydraulic nozzle	HN	\$575.35
3/4" NPT	hydraulic nozzle with plug	HN-P	629.30
---	hydraulic nozzle plug	HN-PLUG	98.90



Hydraulic Oil Receivers

Male Thread	Description	Anodized Aluminum	
		Part #	Price/E
3/4" NPT	hydraulic receiver	HR	\$463.00
3/4" NPT	hydraulic receiver with cap	HR-C	521.40
---	hydraulic receiver cap	HR-CAP	98.90



Transmission Fluid Nozzles

Features:

- **bright violet**
- 6 steel dog latching mechanism
- ergonomically engineered pullbacks and caps

Male Thread	Description	Anodized Aluminum	
		Part #	Price/E
1/2" NPT	transmission nozzle	TN	\$516.95
1/2" NPT	transmission nozzle with plug	TN-P	570.85
---	transmission nozzle plug	TN-PLUG	98.90



Transmission Fluid Receivers

Female Thread	Description	Anodized Aluminum	
		Part #	Price/E
3/8" NPT	transmission receiver	TR	\$269.75
3/8" NPT	transmission receiver with cap	TR-C	328.15
---	transmission receiver cap	TR-CAP	98.90



R Series Connectors

Features:

- fully compatible and interchangeable with industry standards
- all-metal construction using anodized aircraft grade aluminum non-wear components
- standard roll-pin locking mechanism
- ergonomically engineered pullbacks and caps

Engine Oil Nozzles

Feature:

- bright red



Female Thread	Description	Anodized Aluminum	
		Part #	Price/E
3/4" NPT	R-series engine nozzle	R-EN	\$445.00
3/4" NPT	R-series engine nozzle with plug	R-EN-P	498.95
---	R-series engine nozzle plug	R-EN-PLUG	98.90

Engine Oil Receivers



Male Thread	Female Thread	Description	Anodized Aluminum	
			Part #	Price/E
1.625-12 UN-2A	1.312-12 UN-2B	R-series engine receiver	R-ER	\$193.30
1.625-12 UN-2A	1.312-12 UN-2B	R-series engine receiver with cap	R-ER-C	251.75
---	---	R-series engine receiver cap	R-ER-CAP	98.90

Coolant Fluid Nozzles

Feature:

- bright teal



Female Thread	Description	Anodized Aluminum	
		Part #	Price/E
1/2" NPT	R-series coolant nozzle	R-CN	\$418.05
1/2" NPT	R-series coolant nozzle with plug	R-CN-P	471.95
---	R-series coolant nozzle plug	R-CN-PLUG	98.90

Coolant Fluid Receivers



Male Thread	Female Thread	Description	Anodized Aluminum	
			Part #	Price/E
1.187-12 UN-2A	.875-14 UN-2B	R-series coolant receiver	R-CR	\$161.85
1.187-12 UN-2A	.875-14 UN-2B	R-series coolant receiver with cap	R-CR-C	220.30
---	---	R-series coolant receiver cap	R-CR-CAP	98.90

Hydraulic Oil Nozzles

- Feature:**
 • bright gold

Female Thread	Description	Anodized Aluminum	
		Part #	Price/E
1" NPT	R-series hydraulic nozzle	R-HN	\$485.45
1" NPT	R-series hydraulic nozzle with plug	R-HN-P	543.85
---	R-series hydraulic nozzle plug	R-HN-PLUG	98.90



Engineered Fluid
Transfer Couplings

Hydraulic Oil Receivers

Male Thread	Female Thread	Description	Anodized Aluminum	
			Part #	Price/E
1.875-12 UN-2A	1.625-12 UN-2B	R-series hydraulic receiver	R-HR	\$242.75
1.875-12 UN-2A	1.625-12 UN-2B	R-series hydraulic receiver with cap	R-HR-C	301.20
---	---	R-series hydraulic receiver cap	R-HR-CAP	98.90

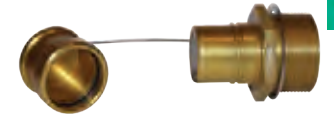

Transmission Fluid Nozzles

- Feature:**
 • bright violet

Female Thread	Description	Anodized Aluminum	
		Part #	Price/E
3/4" NPT	R-series transmission nozzle	R-TN	\$395.55
3/4" NPT	R-series transmission nozzle with plug	R-TN-P	449.50
---	R-series transmission nozzle plug	R-TN-PLUG	98.90



Transmission Fluid Receivers

Male Thread	Female Thread	Description	Anodized Aluminum	
			Part #	Price/E
1.312-12 UN-2A	1.062-12 UN-2B	R-series transmission receiver	R-TR	\$179.80
1.312-12 UN-2A	1.062-12 UN-2B	R-series transmission receiver, cap	R-TR-C	238.25
---	---	R-series transmission receiver cap	R-TR-CAP	98.90



High Flow 3/4" Series Connectors

Features:

- 6 nozzle and receiver sets color coded for quick identification of mating parts; each color nozzle and receiver only couples with matching color component providing complete protection against cross contamination
- maximum flow rate: 50 GPM at 40 PSI
- working pressure rating: **200 PSI**

Nozzles

Male Thread	Description	Anodized Aluminum	
		Part #	Price/E
3/4" NPT	red nozzle with plug	ENBL-P	\$629.30
	gold nozzle with plug	ENBL-P2	629.30
	teal nozzle with plug	ENBL-P3	629.30
	violet nozzle with plug	ENBL-P4	629.30
	navy nozzle with plug	ENBL-P5	629.30
	copper nozzle with plug	ENBL-P6	629.30

Receivers

Male Thread	Description	Anodized Aluminum	
		Part #	Price/E
3/4" NPT	red receiver with cap	ERS-C	\$305.65
	gold receiver with cap	ERS-C2	305.65
	teal receiver with cap	ERS-C3	305.65
	violet receiver with cap	ERS-C4	305.65
	navy receiver with cap	ERS-C5	305.65
	copper receiver with cap	ERS-C6	305.65

- ERS series is available with JIC bulkhead base, substitute 'J' for 'S', example: ERJ-C2

High Flow 1" Series Connectors

Features:

- 7 color coded nozzle and receiver sets for quick identification of mating parts; nozzle and receiver only couple with matching color component providing complete protection against cross contamination
- nozzle/receiver combination has a flow area equivalent to a 1" schedule 80 pipe
- working pressure: **500 PSI** with burst pressure: **1500 PSI**
- all wear parts are stainless steel; all non-wear parts are colored anodized aircraft grade aluminum
- standard nozzle mounting: 1" female NPT; receiver: 1" male NPT
- nozzle incorporates a ball lock mechanism ensuring smooth and reliable operation
- length: nozzle 3.90" (99 mm), receiver 3.44" (87 mm)
- nozzle and receiver coupled length: 5.44" (138 mm)
- diameter: 2.50" (64 mm)
- hex size: 2" (51 mm)

Nozzles

Female NPT	Description	Anodized Aluminum	
		Part #	Price/E
1"	red nozzle with plug	HFN-P1	\$705.65
	gold nozzle with plug	HFN-P2	705.65
	teal nozzle with plug	HFN-P3	705.65
	violet nozzle with plug	HFN-P4	705.65
	navy nozzle with plug	HFN-P5	705.65
	copper nozzle with plug	HFN-P6	705.65
	blue/gray nozzle with plug	HFN-P7	705.65

Receivers

Male NPT	Description	Anodized Aluminum	
		Part #	Price/E
1"	red receiver with cap	HFR-C1	\$444.96
	gold receiver with cap	HFR-C2	444.96
	teal receiver with cap	HFR-C3	444.96
	violet receiver with cap	HFR-C4	444.96
	navy receiver with cap	HFR-C5	444.96
	copper receiver with cap	HFR-C6	444.96
	blue/gray receiver with cap	HFR-C7	444.96

FloMAX Part Number Cross Reference

Standard Series Connectors

R Series Connectors

Dixon® Part #	Caterpillar® Part #	Wiggins Part #
Engine Oil Nozzles		
ENBL	9S9273	OS2
ENBL-P	---	OSP2
ENBL-PLUG	9S9274	OP-12
ERJ	---	ON6
Engine Oil Receivers		
ERS	9S9271	ON2
ERS-C	---	ONC2A
ERS-CAP	9S9272	O3B12P
Coolant Fluid Nozzles		
CN	108-5455	EC280B8
CN-P	---	---
CN-PLUG	108-5456	1209-8
Coolant Fluid Receivers		
CR-S	IQ5459	EC285A8
CR-C	---	---
CR-CAP	5P3587	1208-8
Hydraulic Oil Nozzles		
HN	108-5433	6000B12
HN-P	---	---
HN-PLUG	---	6009-12
Hydraulic Oil Receivers		
HR	108-5454	6005A12
HR-C	---	---
HR-CAP	IQ-5468	6008-12
Transmission Fluid Nozzles		
TN	126-7538	C-1807
TN-P	---	---
TN-PLUG	---	P-1844
Transmission Fluid Receivers		
TR	108-5456	P-1804
TR-C	---	---
TR-CAP	SP3587	P-1880

Dixon® Part #	Caterpillar® Part #	Wiggins Part #
Engine Oil Nozzles		
R-EN	---	R15
R-EN-P	---	---
R-EN-PLUG	---	R1507
Engine Oil Receivers		
R-ER	---	R16
R-ER-C	---	---
R-ER-CAP	---	R1605
Coolant Fluid Nozzles		
R-CN	---	R11
R-CN-P	---	---
R-CN-PLUG	---	R1107
Coolant Fluid Receivers		
R-CR	---	R12
R-CR-C	---	---
R-CR-CAP	---	R1205
Hydraulic Oil Nozzles		
R-HN	---	R17
R-HN-P	---	---
R-HN-PLUG	---	R1707
Hydraulic Oil Receivers		
R-HR	---	R18
R-HR-C	---	---
R-HR-CAP	---	R1805
Transmission Fluid Nozzles		
R-TN	---	R13
R-TN-P	---	---
R-TN-PLUG	---	R1307
Transmission Fluid Receivers		
R-TR	---	R14
R-TR-C	---	---
R-TR-CAP	---	R1405

Diesel Fueling System

Fuel Vent Series

Dixon® Part #	Caterpillar® Part #	Wiggins Part #
VT	6G7803	ZV10
VT7	---	ZV10F
VT9	---	ZV10
VTT	5V6106	ZV10C
VT-C	---	ZV10A
VT-A-7	9G01965	ZV11
VT-A-9	4T1314	ZV11A

Dixon® Part #	Caterpillar® Part #	Wiggins Part #
Nozzles		
FN600	---	ZZF150
FN600BL	---	ZZ9A1
FN600B-PLUG	---	---
Receivers		
FRS	2G9000	ZN2A
FRS-C	---	ZNC2A
FRA	---	ZN2A
FRA-C	---	ZNC2A
FR-CAP	0D0630	ZC20P
FR2	9D0630	---
FR2-C	---	---
FR2-R	---	---
GFR-0	---	ZN6A
GFR-45	---	---
GFR-90	---	ZN6B
GFR1-0	---	ZN6B
GFR1-45	---	---
GFR1-90	---	ZN6B
FNS	---	ZS9
FNS2	---	---
FN600S	---	---
BFN	---	ZS5
BH-F	---	---
FNS10	---	---
FR-SOCKET	---	---
BH-W	---	---



API Couplers

Features:

- completely modular coupler can be built with various face seal combinations to be compatible with different alternative fuel / performance levels and applications
- 4" TTMA inlet mounting flange
- 5 cam design for easy alignment and tight connection
- ball-end handle for easy, comfortable operation
- no special tools needed for maintenance
- shaft seals can be changed without removing coupler from loading arm
- link, shaft, pin and crank: hardened 17-4PH stainless steel
- cam: stainless steel
- weight: 20 lbs.
- maximum working pressure: **150 PSI**
- peak surge pressure: **350 PSI**
- maximum flow rate: 1000 GPM
- pressure drop: **3 to 4 PSI**
- replacement parts are available, contact Dixon®



API Couplers with Bonded Nose Seal

Seal Material	Operating Temperature	Part #	Price/E
<i>Buna</i>	-20°F to 250°F (-29°C to 121°C)	5300	\$2343.25
<i>FKM-B</i>	-10°F to 400°F (-23°C to 204°C)	5300B	2577.60
<i>FKM-GFLT</i>	-20°F to 400°F (-29°C to 204°C)	5300G	2577.60
<i>FKM-B with stainless wave spring</i>	-10°F to 400°F (-23°C to 204°C)	5300BC¹	2636.00
<i>FKM-B with stainless wave spring</i>	-10°F to 400°F (-23°C to 204°C)	5300BCL	2700.00

¹ stainless steel internal springs and is recommended for crude oil service

API Couplers with Replaceable Nose Seal

Seal Material	Operating Temperature	Part #	Price/E
<i>Buna</i>	-20°F to 250°F (-29°C to 121°C)	5400	\$2343.25
<i>FKM-B</i>	-10°F to 400°F (-23°C to 204°C)	5400B	2577.60
<i>FKM-GFLT</i>	-20°F to 400°F (-29°C to 204°C)	5400G	2577.60

API Coupler Locking Handle Repair Kit



Description	Part #	Price/E
locking handle kit for 5300BC rack couplers	5354K21	\$234.18

API Load Only Valves

Application:

- used for bottom loading and unloading of petroleum tankers, typically mounted to the piping below each tank compartment using the built-in 4" TTMA flange connection



Description	Part #	Price/E
load only API valve without sight glass, ALH nose ring	5204LNG	\$547.50
load only API valve without sight glass, Baylast™ seal, stainless steel springs	5204LSNG	643.75
load only API valve without sight glass, Baylast™ seal, stainless steel springs with 1/2" FNPT drain port	5204LSNGP	721.00

API Load/Unload Valves



Description	Part #	Price/E
load/unload API valve with sight glass, ALH nose ring	5204	\$799.00
load/unload API valve, without sight glass, fixed handle, Baylast™ seal	5204NG	777.65

API Drop Adapters

Application:

- for offloading through an API adapter

Adapter Size	Coupler Size	Description	Aluminum	
			Part #	Price/E
3"	4" API	with Baylast™ O-ring seal	4530	\$202.00
4"	4" API	with Baylast™ O-ring seal	4540	202.00
4"	4" API	with Buna-N O-ring seal	4540F	347.20



API Drop Adapters with Sight Glass

Adapter Size	Coupler Size	Description	Aluminum	
			Part #	Price/E
3"	4" API	with inline sight glass and Baylast™ flat gasket	4530SG	\$257.00
4"	4" API	with inline sight glass and Baylast™ flat gasket	4540SG	259.45



API Gravity Drop Adapters

Adapter Size	Coupler Size	Description	Aluminum	
			Part #	Price/E
3"	4" API	with flat Buna gasket	31440-225AL	\$183.80
4"	4" API	with flat Buna gasket	41440-225AL	189.60



API Drop Adapter Repair Kits

Description	Part #	Price/E
replacement cam arms, pins and Baylast™ O-ring seal (standard)	4500RK	\$27.60
replacement cam arms, pins and FKM O-ring seal (optional)	4500RK-V	48.30
replacement 18" chain and S hook	5205-RK4	11.10
sight glass repair kit (fits 3" and 4")	4540SG-RK1	67.55
flat replacement Baylast gasket for 4530SG, 4540SG	4540SG-RK2	8.80
replacement cam arms and pins (fits 3" and 4")	4540SG-RK3	30.80
Baylast O-ring replacement seal for 4530, 4540, 5000-24	4500-5	7.30
flat replacement gasket for 31440-225AL, 41440-225AL, 41450-DCAL	2143SEALBU	13.00

API Dust Caps

Size	Description	Aluminum		Optional Qty
		Part #	Price/E	
4" API	with flat Buna gasket and brass cam arms	41450-DCAL	\$159.00	5
	with O-ring Baylast™ seal and brass cam arms	5000-24	127.90	10
	with locking arms	5000-24L	131.85	1



Adapter Size	Description	Nylon		Optional Qty
		Part #	Price/E	
4" API	with flat Buna seal and plated steel pad lockable roller lever	5000-25	\$89.50	20





4540DC



4540DC-1200

Gravity Drop Adapter Dust Caps

Features:

- designed to fit on any 4" cam and groove adapter, specifically 4" gravity drop adapters
- reduce weight
- easy Pull Off / Push On operation
- Buna gasket
- NOT intended to be pressurized

Size	Black Nylon	
	Part #	Price/E
4"	4540DC	\$96.15
4"	4540DC-1200¹	109.00

¹ supplied with chain

Dixon Bayco Adapter with Grounding Tab



Size	Description	356T6 Aluminum	
		Part #	Price/E
4"	male adapter with grounding tab	400-C-ALGT	\$111.15

Dixon Bayco Coupler with Grounding Tab



Size	Description	356T6 Aluminum	
		Part #	Price/E
4"	female coupler with grounding tab	400-E-ALGT	\$75.80

API Compatible Loading Rack Cords

Features:

- highly visible safety orange jacket meets trip hazard requirements
- cord is bonded mechanically and resistant to abrasion and oil
- Cord sets are interchangeable with Scully and Civacon. All wiring is compatible with standard Scully color codes and wiring number configurations. The 9 pin conductor is shielded to be compatible with Scully VIP system.
- plug body is reinforced nylon and is color coded Optic Blue or Thermistor Green
- button contacts are 316 stainless steel to prevent corrosion or galling
- all other hardware is stainless steel

API Optic Cord Assemblies



FT620

Description	Part #	Price/E
plug with 30' coiled cable, 6 contact pins, 3 J slots	FT620	\$1099.15
plug with 20' straight cable, 6 contact pins, 3 J slots	FT620S	1045.95
plug with 30' coiled cord, 6 contact pins, 3 J slots, J560 plug	FT620P	1305.00
replacement plug assembly with 6 contact pins, 3 J slots	FT621	585.05
replacement 30' coiled cable, optic 6 conductor	FT622	620.00
plug storage hanger	FT623	340.45
replacement 20' straight cord, optic 6 conductor	FT624	1050.00

API Thermistor Cord Assemblies

Description	Part #	Price/E
plug with 30' coiled cable, 8 contact pins, 2 J slots	FT600	\$1099.15
plug with 30' coiled cable, 8 contact pins, 2 J slots, 13 pin connector	FT600P	1439.39
plug with 30' coiled cord, 10 contact pins, 2 J slots (for Canada)	FT600C	1099.15
plug with 20' straight cable, 8 contact pins, 2 J slots	FT600S	1045.95
plug with 30' coiled cable, 10 contact pins, 4 J slots	FT600CP	1439.40
plug with 20' straight cable, 10 contact pins, 4 J slots (for Canada)	FT600SC	1045.95
replacement plug assembly with 8 contact pins, 2 J slots	FT601	568.00
replacement plug assembly with 10 contact pins, 4 J slots (for Canada)	FT601-10	568.00
replacement 30' coiled cable, Thermistor 10 conductor	FT602	620.00
plug storage hanger	FT603	330.50
replacement 20' straight cord, Thermistor 10 conductor	FT604	825.00



API Rack Cord Assemblies

FloTech Part #	Civacon Part #	Scully Part #	API		Cord		J-Slots			Pins			Breakaway Plug	
			Thermistor	Optic	20' Straight	30' Coiled	2	3	4	6	8	10	Optic "J560" Aluminum	Thermistor 13 Pin Plastic
FT600	7300SR-7300	21818	✓			✓	✓				✓			
FT600-4			✓			✓		✓		✓				
FT600C	7300CSR-7300	31092	✓			✓		✓			✓			
FT600C-2	7300C-7300		✓			✓	✓				✓			
FT600P	7320SR-7320		✓			✓	✓				✓			✓
FT600P-4			✓			✓		✓		✓				✓
FT600S	7300-STRAIGHT	20830	✓		✓			✓			✓			
FT600SC	7300C-STRAIGHT		✓		✓			✓			✓			
FT600CP			✓			✓		✓		✓				✓
FT600SP			✓				✓				✓			✓
FT605C				✓		✓		✓	✓					
FT620	7100SR-7100	21831		✓		✓		✓	✓					
FT620P	7100-J560			✓		✓		✓	✓			✓		
FT620X620				✓		✓		✓	✓					
FT620S	7100-STRAIGHT	21764		✓	✓			✓	✓					

API Rack Cord Parts

FloTech Part #	Civacon Part #	Scully Part #	API		Cord		J-Slots				Pins		
			Thermistor	Optic	20' Straight	30' Coiled	2	3	4	6	8	10	
FT601	7310SR-7310		✓					✓				✓	
FT601-4			✓							✓		✓	
FT601-10			✓							✓			✓
FT602			✓			✓							
FT603	7350-7350		✓							✓			
FT604			✓		✓								
FT621	7110SR-7110	21766		✓				✓			✓		
FT622	7220-7220	31099		✓				✓					
FT623	7150-7150			✓				✓					
FT624		31098		✓	✓	✓							

Dixon® Vapor Recovery Couplers

- not intended for liquid service, for vapor recovery *only* 

Materials:

- body: cast aluminum
- arms: bronze with stainless steel pins
- finger rings: plated carbon steel
- gasket: Buna-N

Dixon® Vapor Recovery Coupler with Probe x Adapter



Coupler Size	Adapter Size	356T6 Aluminum	
		Part #	Price/E
4"	3"	4030-DAVR-AL	\$139.50

Dixon® Vapor Recovery Coupler with Probe x Coupler with Probe



Coupler Size	Coupler Size	356T6 Aluminum	
		Part #	Price/E
4"	4"	400-DDVR-AL	\$160.00

Dixon® Vapor Recovery Coupler with Probe x Hose Shank



VR4030CS-AL

Applications:

- for use with 3" vapor hose
- not intended for liquid service, for vapor recovery *only* 

Features:

- cast aluminum body, bronze arms with stainless steel pins and finger rings
- Buna-N gasket
- VR4030CS-AL has an FKM O-ring poppet seal
- *Dixon® replacement handle assemblies will not work on these fittings, contact Dixon® for replacements.* 



VRC.3000AL

Coupler Size	Hose Shank Size	Description	Part #	Price/E
3"	3"	---	VRC3000AL	\$144.05
4"	2"	---	4020-CVR-AL	128.00
4"	3"	no poppet	4030-CVR-AL	129.10
4"	3"	poppet	VR4030CS-AL ¹	213.25
4"	3"	floating bridge poppet	VR4030CS-SH ²	584.00
4"	4"	no poppet	400-CVR-AL	137.00
4"	4"	floating bridge poppet	VR4040CS-AL ²	412.00

- ¹ interchanges with all competitor vapor valves *except* Civacon #633LVH (special bulb design). 
- ² superior interface with air interlock



4030-CVR-AL

Repair Kits

Description	Part #	Price/E
seal repair kit: gasket, machine screw and FKM O-ring	VR4040CSRK1	\$21.35
cam arm repair kit: paddle arm and cam arm pin	VR4040CSRK2	74.35

Dixon® Vapor Recovery Coupler x 45° Hose Shank



Features:

- 'floating bridge' poppet design allows optimal flow
- machined hose shank ensures easier insertion into hose and better sealing
- durable, easy to couple stainless cam arms
- big wings ensure contact with air interlock button on tanker helping prevent drive-offs
- change poppet seal without removing the coupler from the hose
- secure to hose with traditional band clamps or built in crimp collar
- 4" MNPT version allows for either cam and groove or threaded flange option
- seal: Buna N
- not intended for liquid service, for vapor recovery *only* 

Coupler Size	Hose Shank Size	Aluminum	
		Part #	Price/E
4"	3"	VR4030CS-AL45	\$683.00
	4"	VR4040CS-AL45	683.00

Dixon® Vapor Recovery with Probe Coupler x Female NPT

- not intended for liquid service, for vapor recovery *only* 

Materials:

- body: cast aluminum
- arms: bronze with stainless steel pins
- finger rings: plated carbon steel
- gasket: Buna-N



Coupler Size	Female NPT Size	356T6 Aluminum	
		Part #	Price/E
4"	3"	4030-DVR-AL	\$155.00
	4"	400-DVR-AL	157.30



Tank Truck Flanged Tee

Size	356T6 Aluminum	
	Part #	Price/E
4"	400-TLT-AL	\$255.00

- For flange dimensions, diagrams and additional information please reference dixonvalve.com.

TTMA Series Flange Adapters

Features:

- simply and easily converts threaded components to a standard TTMA flange configuration
- solid cast lightweight aluminum design is more durable than welded fabrications
- design improves flow through adapter
- compact size reduces the overall space needed to install

TTMA Flange x Male NPT Adapters



TTMA Flange	Male NPT	Overall Length	Aluminum	
			Part #	Price/E
3"	3"	2½"	TTF3AL-3MT	\$87.50
4"	3"	2½"	TTF4AL-3MT	65.90
4"	4"	2½"	TTF4AL-4MT	61.10

TTMA Flange x Extended Length Male NPT Adapters



TTMA Flange	Male NPT	Overall Length	Aluminum	
			Part #	Price/E
4"	3"	5½"	TTF4AL-3EMT	\$87.50
	4"	5½"	TTF4AL-4EMT	102.15

TTMA Flange x Female NPT Adapter



TTMA Flange	Female NPT	Overall Length	Aluminum	
			Part #	Price/E
4"	3"	2½"	TTF4AL-3FT	\$78.35
	4"	2½"	TTF4AL-4FT	78.05

TTMA Slip-on Socket Weld Flange



TTMA Flange	Pipe Size	356T6 Aluminum	
		Part #	Price/E
4"	4"	TTF400SP	\$67.00

TTMA Slip-on Plate Flange



TTMA Flange	Pipe Size	Aluminum	
		Part #	Price/E
4"	4"	TTMA-64	\$29.75

TTMA Buttweld Flange



TTMA Flange	Pipe Size	Thickness	Aluminum	
			Part #	Price/E
3"	4"	⅜"	TTF3AL	\$26.58
4"	4"	⅜"	TTF4AL	33.29

- For flange dimensions, diagrams and additional information please reference dixonvalve.com.

TTMA Flange Spacer with 1/2" Port

Size	Description	Aluminum	
		Part #	Price/E
4"	flange spacer with 1/2" female NPT port	TTFS4AL-FP50	\$185.60



TTMA Flange Extensions

Application:

- used on load arms to connect an API load coupler to a load arm

Features:

- adds a 6" space between the load arm and the tank truck
- extension with groove provides a specified parting point to prevent excessive damage to the loading arm



TETF4AL



TETFG4AL

Size	Description	Aluminum	
		Part #	Price/E
4"	TTMA flange extension	TETF4AL	\$130.00
4"	TTMA flange extension with groove	TETFG4AL	133.50
4"	TTMA flange extension with 1/2" female NPT port	TETF4ALFP50	304.85

- For flange dimensions, diagrams and additional information please reference dixonvalve.com.

Dixon™ Adapters and Couplers x TTMA

Features:

- aluminum flanges have a flat face, stainless flanges have a raised face
- reference dixonvalve.com for flange drilling standards
- pressure rating is based on the seal of the mating part, see ratings on page D-5

Size	356T6 Aluminum		316 Stainless Steel	
	Part #	Price/E	Part #	Price/E
3"	300-ALT-AL	\$78.25	300-ALT-SS¹	\$480.00
3" x 4"	3040ALTAL	112.80	---	---
4"	400-ALT-AL	84.70	400-ALT-SS¹	750.00
6"	600-ALT-AL	236.00	---	---



¹ parts are produced as a welded fabrication

Cam & Groove Coupler x TTMA Flange

Features:

- supplied standard with a Buna-N gasket, other gaskets available on pages D-48 to D-50
- use Dixon® replacement handles only

Size	356T6 Aluminum	
	Part #	Price/E
3"	300-DLT-AL	\$142.60
3" x 4"	3040DLTAL	159.40
4"	400-DLT-AL	167.00
6"	600-DLT-AL	350.00



- For flange dimensions, diagrams and additional information please reference dixonvalve.com.

Cam & Groove 22 1/2° Adapter x TTMA Flange

Feature:

- pressure rating is based on the seal of the mating part, see ratings on page D-5

Size	356T6 Aluminum	
	Part #	Price/E
4"	40022ALTAL	\$186.30



Cam & Groove 22 1/2° Coupler x TTMA Flange

Features:

- supplied standard with a Buna-N gasket, other gaskets available on pages D-48 to D-50
- use Dixon® replacement handles only

Size	356T6 Aluminum	
	Part #	Price/E
4"	40022DLTAL	\$153.60



- For flange dimensions, diagrams and additional information please reference dixonvalve.com.



TTMA Flange Gaskets

Size	OD	ID	Thick.	Material	Part #	Price/E
3"	5-5/8"	3-1/2"	1/8"	Cork / Buna	300GTTFCB	\$3.90
	5-5/8"	3-1/2"	1/16"	PTFE envelope with Klinger filler	300GTTFTK	17.25
	5-5/8"	3-1/2"	1/8"	Klingersil® C-4300	300GTTFK	9.95
	5-29/32"	3-1/2"	3/32"	PTFE with fiber core	40321TF	22.65
	7-1/4"	5"	5/32"	PTFE with soft fiber core	40364TF	95.45
	5-5/8"	3-5/8"	1/8"	Baylast™	40364BL	20.61
4"	6-5/8"	4-9/16"	1/8"	Cork / Buna	400GTTFCB	4.60
	6-5/8"	4-9/16"	1/16"	PTFE envelope with Klinger filler	400GTTFTK	23.00
	6-5/8"	4-9/16"	1/8"	Klingersil® C-4401	400GTTFK	18.25
	6-7/8"	4-9/16"	3/32"	PTFE with fiber core	40322TF	42.30
	8-3/8"	5-7/8"	5/32"	PTFE with soft fiber core	40323TF	70.00
	8-1/4"	5-7/8"	1/8"	Baylast™	40323BL	25.61
	6-5/8"	4-5/8"	1/8"	Baylast™	400GTTFBL	25.50

• For flange dimensions, diagrams and additional information please reference dixonvalve.com.

Sight Flow Indicators

Features:

- Due to the proprietary blending of petroleum products, Dixon® recommends that thermoplastic tubing and gaskets be immersion tested in the product to be handled to ensure compatibility (not compatible with crude oil).
- for dimensional information on tank truck flange drilling reference dixonvalve.com
- maximum flange bolt torque is 200 in-lb (inch pounds)



TTMA Flanged Short Sight Flow Indicators

Features:

- durable cast aluminum housing, replaces competitions all acrylic sight glass as commonly found on tank trucks
- allows for visual identification of the fuel grade prior to opening the valve
- works with tank truck flanged butterfly valves found on gasoline trucks
- low cost sight glass tube can be easily replaced
- rated to **150 PSI**



Size	Width	Aluminum	
		Part #	Price/E
3"	1 3/4"	5200-SFI-3	\$165.55
4"	1 3/4"	5200-SFI	180.95

TTMA Flanged Sight Flow Indicators

Features:

- allows for visual identification of the fuel grade prior to opening the valve
- works with tank truck flanged butterfly valves found on gasoline trucks
- larger ID 4 3/8" flow indicator allows tank truck flanged butterfly valves to connect to either end of the indicator
- pressure rating: **150 PSI**



Size	Width	ID	Aluminum	
			Part #	Price/E
4"	3 1/4"	4 3/8"	5201-SFI	\$256.25

Features:

- allows for visual identification of the fuel grade prior to opening the valve
- 4" flow diameter



Size	ID	Aluminum	
		Part #	Price/E
4"	4 3/8"	4-1460-AL	\$190.10

• For flange dimensions, diagrams and additional information please reference dixonvalve.com.

TTMA Flanged Sight Flow Indicators

Size	Nominal Width	Acrylic	
		Part #	Price/E
3"	1 3/4"	TT3ASG	\$116.00
4"	1 3/4"	TT4ASG	116.00
3"	1 3/4"	TT3ASG-ETH¹	370.00
4"	1 3/4"	TT4ASG-ETH¹	370.00

Optically Enhanced Sight Glass

Size	Nominal Width	Acrylic	
		Part #	Price/E
3"	1 3/4"	TT3ASGOE	\$130.00
4"	1 3/4"	TT4ASGOE	130.00
3"	1 3/4"	TT3ASG-ETHOE¹	370.00
4"	1 3/4"	TT4ASG-ETHOE¹	370.00



¹ for use with ethanol

• For flange dimensions, diagrams and additional information please reference dixonvalve.com.

Sight Flow Indicator Repair Kits

Description	Used on	Part #	Price/E
3" replacement sight glass, Baylast™ O-ring and retainer ring kit	---	5200-SFI-3-RK1	\$80.75
3" replacement sight glass, FKM O-ring and retainer ring kit	---	5200-SFI-3V-RK1	149.60
4" replacement sight glass, Baylast™ O-ring and retainer ring kit	---	5200-SFI-RK1	80.75
4" replacement sight glass, FKM O-ring and retainer ring kit	---	5200-SFIV-RK1	149.60
replacement Baylast O-rings, sight glass and retaining ring	5201-SFI	5201-SFI-RK1	84.45
Buna-N O-ring	---	O249BU	4.75
plexiglass insert	---	4PSG	84.00
Buna-N O-ring	---	O246BU	4.25



5200-SFIV-RK1

TTMA Flange Screen

Feature:

- stainless steel screen is encapsulated in an FKM gasket

Male NPT	Description	Stainless Steel	
		Part #	Price/E
2"	screen with 1" square holes	TTFS4SS	\$150.00

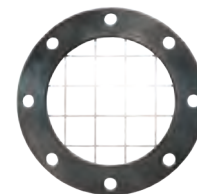

• For flange dimensions, diagrams and additional information please reference dixonvalve.com.

Tank Transport Fusible Pipe Caps



Size	Stainless Steel ¹		Aluminum		Iron		Optional Qty
	Part #	Price/E	Part #	Price/E	Part #	Price/E	
3"	300-SFC-SS	\$118.90	300-SFC-AL	\$125.53	300-SFC-MI	\$120.00	10

¹ PTFE gaskets are standard in stainless steel fittings.

Tank Transport Pipe Caps



Size	Stainless Steel ¹		Aluminum		Iron		Optional Qty
	Part #	Price/E	Part #	Price/E	Part #	Price/E	
2"	200-PC-SS	\$121.00	---	---	200-PC-MI	\$40.00	---
3"	300-PC-SS	89.75	300-PC-AL	\$44.75	300-PC-MI	50.40	10
4"	400-PC-SS	248.00	---	---	---	---	---

¹ PTFE gaskets are standard in stainless steel fittings.

Tank Transport Reducers



Female NPSM	Male NPT	Stainless Steel ¹		Aluminum		Iron		Optional Qty
		Part #	Price/E	Part #	Price/E	Part #	Price/E	
3"	2"	3020-RD-SS	\$140.00	3020-RD-AL	\$85.00	3020-RD-MI	\$58.00	10
4"	3"	4030-RD-SS²	570.00	4030-RD-AL	128.00	---	---	---

¹ PTFE gaskets are standard in stainless steel fittings.

² welded fabrication

Tank Transport Reducing Cap



Size	Stainless Steel ¹		Optional Qty
	Part #	Price/E	
3" x 1"	3010-RC-SS	\$196.00	10

¹ PTFE gaskets are standard in stainless steel fittings.

Coupling Gaskets



Size	Buna-N		Opt Qty	PTFE		Optional Qty
	Part #	Price/E		Part #	Price/E	
1½"	---	---	--	150GPCTF	\$5.70	--
2"	200GPCBU	\$2.10	25	200GPCTF	4.95	10
3"	300GPCBU	2.35	25	300GPCTF	6.45	25
4"	---	---	--	400GPCTF	15.00	--

Intermodal Tank Transport Pipe Caps

Size	Aluminum		Stainless Steel ¹		Optional Qty
	Part #	Price/E	Part #	Price/E	
3"	300PCALAP	\$59.95	300PCSSAP	\$102.50	10

¹ PTFE gaskets are standard in stainless steel fittings



Intermodal Tank Transport Thread Adapters

Female BSPP	Male NPT	Stainless Steel ¹	
		Part #	Price/E
3"	2"	3020RDSSAP	\$175.00
	3"	3030RDSSAP	255.00

¹ PTFE gaskets are standard in stainless steel fittings



Intermodal Tank Transport Cam & Groove Adapter

Size	Stainless Steel ¹	
	Part #	Price/E
3"	300ASSAP	\$152.00

¹ PTFE gaskets are standard in stainless steel fittings



6200 Series Side Lever Type Drop Elbows

Features:

- cast aluminum modular construction
- brass handle and cam arms with buna gasket
- stainless steel bolts on inlet end
- acrylic sight glass with buna seals
- for information on additional elbow configurations such as pre-assembled elbows, contact Dixon®

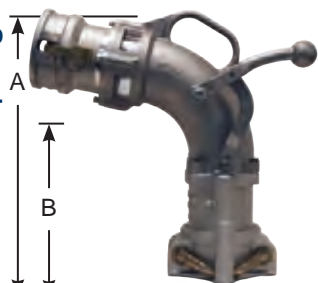

side lever with 4" coupler inlet



side lever without inlet connection

Size	Inlet	A Overall Height	B Ground Clearance	Aluminum	
				Part #	Price/E
4"	elbow only, <i>without inlet connection</i>	17¾"	10⅞"	6200	\$933.70
	elbow with 4" adapter inlet			6200A	1049.55
	elbow with anti-spill sleeve, <i>without inlet connection</i>			6200T	1016.40
	elbow with 4" coupler inlet			6200D	1134.25
4"	tall elbow only, <i>without inlet connection</i>	21"	13¾"	6200X	1042.50
	tall elbow with 4" adapter inlet			6200XA	1175.90
	tall elbow with anti-spill sleeve, <i>without inlet connection</i>			6200XT	1131.10
	tall elbow with 4" coupler inlet			6200XD	1249.30

6500 Series Self-Locking Drop Elbows



no inlet

Size	Inlet	A Overall Height	B Ground Clearance	Aluminum	
				Part #	Price/E
4"	tightfill elbow with locking handle	17¾"	10⅞"	6500	\$988.35
4"	tightfill elbow with locking handle and 4" adapter inlet	17¾"	10⅞"	6500A	1042.75

Male Adapter Inlets



Inlet Size	Aluminum	
	Part #	Price/E
3"	6000-16	\$99.90
4"	6000-17	99.90

Female Coupler Inlets



Inlet Size	Aluminum	
	Part #	Price/E
3"	6000-15	\$183.15
4"	6000-14	183.15

Female NPT Inlet



Inlet Size	Aluminum	
	Part #	Price/E
4"	6000-20	\$100.05

Dual Point Vapor Recovery Elbows - Ball Lever

Features:

- for use in two point vapor recovery systems
- one-piece locking arms
- advanced design side lever locking system
- bolt on 3" male outlet included (**VR6000-6**) which can be rotated for extended life
- lubrication fitting on locking stem
- see below for 6400 series co-axial elbow for single point vapor recovery

Materials:

- seals: buna
- hardware: stainless steel
- bronze locking arms housed in polymer bushings



Description	Aluminum	
	Part #	Price/E
3" male adapter with probe, without poppet valve	VR6200NP	\$732.80
3" male adapter outlet with probe and poppet valve	VR6200	834.35

Adapter Inlet

Description	Aluminum	
	Part #	Price/E
outlet adapter with outlet O-ring	VR6000-6	\$63.35



Single Point Coaxial Drop Elbow

Features:

- for single point vapor recovery only
- 3" male vapor outlet (top)
- comes assembled with 4" male inlet
- bolt-on inlets/outlets for easy, fast replacement
- replacement parts are available, please contact Dixon®
- 6400 co-axial inlets do not fit our other elbow series

Materials:

- arms: solid bronze
- sight glass: acrylic
- seals: buna

Inlet	Outlet	Aluminum	
		Part #	Price/E
4" male	3" male vapor	6400	\$1363.95

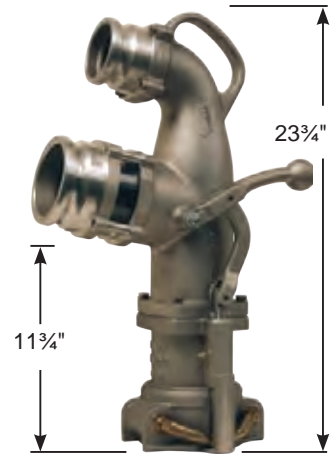

Coaxial Elbow Adapter Fuel Inlets

Features:

- for use with 6400 series coaxial elbows only
- rated for petroleum service, Ethanol to E100 and biodiesel to B20

Size	Aluminum	
	Part #	Price/E
3"	6000-16C	\$99.90
4"	6000-17C	99.90



Coaxial Elbow Coupler Fuel Inlets

Features:

- for use with 6400 series coaxial elbows only
- rated for petroleum service, Ethanol to E100 and biodiesel to B20

Size	Aluminum	
	Part #	Price/E
3"	6000-15C	\$183.15
4"	6000-14C	183.15





Tight Fill Drop Elbows - Complete Unit

Materials:

- body: aluminum
- handle and cam arms: brass
- gasket: buna
- bolts on inlet end: steel
- sight flow insert: plexiglass

Coupler Size	Inlet	Aluminum	
		Part #	Price/E
3"	3" male adapter	300300MAE	\$694.00
	4" male adapter	3004030MAE	726.00

Tight Fill Drop Elbow Coupler Body



Size	Aluminum	
	Part #	Price/E
3"	300-TFG	\$650.00

Tight Fill Male Adapter Inlet End



Inlet	Aluminum	
	Part #	Price/E
3"	300-MAE	\$71.00
4"	4030-MAE	105.00

Side Seal Drop Elbow



Features:

- for use with special 4" side seal style fill collars only
- modular, easy to repair, bolt together construction
- standard with acrylic sight glass with buna seals (2), bronze locking levers and buna main seal
- 4" male adapter inlet and lock ring installed
- replacement parts are available, contact Dixon®

Part #	Aluminum	
	Price/E	
6000ASAL	\$829.75	

Side Seal to Top Seal Adapter



Features:

- allows conventional elbows to be used with special side seal style fill collars
- bottom connects to side seal fill collar
- top section with standard 4" top seal collar profile accepts clamping of standard 4" drop elbows
- replacement parts are available, contact Dixon®

Size	Aluminum	
	Part #	Price/E
4"	6000-SSA	\$377.15

Dust Cap with Pull Handle for Hose Tubes

Features:

- Pull handles make it easier for tanker operators to remove delivery hoses from the storage tubes; the operator simply grabs the handle and easily pulls the hose out of the storage tube.
- Rugged construction protects the hose coupling and adapter from damage during transportation and removal of hoses from the hose storage tube.
- prevents possible environmental issues due to leaking residue left in an open hose

Materials:

- aluminum body
- cam arms (dust caps): brass
- seals: buna



4"

Size	Aluminum	
	Part #	Price/E
3"	300-DC-ALPH	\$79.80
4"	400-DC-ALPH	91.85

Dust Plug with Pull Handle for Hose Tubes

Dust caps and dust plugs are not to be used in pressure applications for safety and environmental reasons.



3"

Size	Aluminum	
	Part #	Price/E
3"	300-DP-ALPH	\$42.15
4"	400-DP-ALPH	42.15



4"

Reelcraft® Static Discharge Reel

Applications:

- Used to ground equipment in hazardous atmospheres, such as fuel trucks or carts transferring flammable materials. When properly clamped to ground, the static discharge reel dissipates static electrical buildup, reduced the chances of sparking and the potential for explosion.

Features:

- supplied with a 3/32" OD steel aircraft cable
- DC resistance is approximately one ohm per 50' of steel cable



Description	Stranded Steel	
	Part #	Price/E
single 7" x 7" stranded steel	G3050	\$675.00

TFA Series Fill Pipe Adapter

**Feature:**

- for use with 3" drop elbows (**300-TFG**)

Adapter Size	Female NPT	Aluminum Hardcoat		Optional Qty
		Part #	Price/E	
3"	3"	300-TFA	\$62.65	10

Fuel Delivery Tank Adapters



with NPSM thread



with NPT thread

Features:

- for use with 4" drop and co-axial elbows (6200, 6400 and 6500 series)
- **BZ4051S** has NPSM thread and is supplied with a gasket

Adapter Size	Female Thread	Height	Bronze		Optional Qty
			Part #	Price/E	
4"	4" NPSM	2 $\frac{3}{8}$ "	BZ4051S	\$110.55	5
	4" NPT	3 $\frac{1}{2}$ "	BZ4051	132.50	5

Vapor Recovery Tank Adapters

**Features:**

- for use with dual point vapor elbows (VR6200 series)
- can also be used as vapor valve on tanker but does not have air interlock mount
- poppeted vapor collar at station vapor outlet
- low profile design
- replacement parts are available, contact Dixon® for more information

Adapter Size	Female Thread	Height	Material	Part #	Price/E	Optional Qty
4"	4" NPT	3 $\frac{5}{8}$ "	bronze	VR4086	\$313.25	5
			ZN-AL alloy	VR4086-BY	246.60	5

Vapor Caps

Aluminum

Features:

- special locking cap for underground tank vapor outlet **VR4086** and tanker vapor valves
- bronze cam arms
- painted vapor recovery orange



Size	Part #	Price/E
4"	VR4050AL	\$108.40

Nylon

Features:

- centered 'T' handle allows for one-handed use and provides a solid locking mechanism
- strong and lightweight
- built-in locking feature
- corrosion resistant materials
- vapor recovery orange
- replacement parts are available, contact Dixon® for more information



Size	Part #	Price/E
4"	VR4050PL	\$66.75

Automatic Pressure / Vacuum Relief Caps

Features:

- normally closed, stops fuel evaporation and airborne contaminants
- lockable
- relieves pressure and vacuum buildup in fuel tanks

Note: Pressure/vacuum relief caps should be routinely inspected to ensure correct operation and particularly to ensure that the relieving components are free to move and that the air flow path is unblocked.



for stationary fuel tanks

Feature:

- relieves vacuum at .7 Hg (.33 PSI) and pressure at 2 PSI, 20 SCFM flow

Male NPT	Part #	Price/E
2"	2000L	\$45.85
2½"	2500L	48.30



for mobile fuel tanks

Feature:

- relieves vacuum at .33 Hg and pressure between 7.5 - 9 PSI

Male NPT	Part #	Price/E
2"	200-PV-9	\$99.90



Standard Vent Caps for Stationary Tanks

**Features:**

- allows venting of tank to atmosphere at all times
- also referred to as a breather cap
- does not have pressure or vacuum valves

Male NPT	Part #	Aluminum	Price/E
2½"	2500SFV		\$43.20

Fuel Delivery Adapter Cap

**Features:**

- single action locking cap
- bronze cam arms
- replacement parts are available, contact Dixon® for more information

Size	Part #	Aluminum	Price/E	Optional Qty
4"	SA4050AL		\$106.10	10

Swivel Joints

Applications:

- used wherever a leak-proof swivel connection is needed in pipelines or in combination with hoses to eliminate hose twisting
- Industries range from petroleum, petrochemical, refining, mining, distilling, paint, farm irrigation and fertilizing, wastewater treatment plants and food and beverage process equipment. Dixon® swivel joints are found in blending plants, drum filling applications, fluid and dry bulk transfer, vacuum trucks, oil and gas trucks and water trucks. Larger swivels can be found in the steel industry, marine bulk transfer and many more.

Features:

- full 360° rotational movement
- wide spacing between dual ball bearing raceways ensures greater load bearing capacity
- precision-machined design ensures alignment and years of trouble-free service
- O-ring dust seal protects the ball races and seals chamber from outside elements
- radius elbow design ensures a smooth flow pattern
- hydrostatic testing is performed on all swivels before shipment

Options Available:

- end configurations: female NPT, 150# flanges, TTMA flange, grooved, weld end and many other variations
- seal options: Buna, FKM, PTFE, EPDM, FDA Buna, FFKM
- ball bearing materials: carbon steel, 440 stainless steel, and 316 stainless steel
- grease materials: Lithium, FDA approved/food grade and silicone
- swivels that include oxygen, steam or submerged service can be specifically designed for unique applications (special order)
- 100% full penetration weld
- re-build kits available
- custom swivel options available, contact Dixon® at 888.226.4673

Swivel configurator available on dixonvalve.com



O-ring Parts Identification List

1. O-ring (dust) seal
2. ball retainer screw
3. O-ring (pressure) seal
4. grease fitting
5. ball bearings

O-ring Features:

- sizes: 1" - 4"
- O-ring pressure seal ensures a leak-proof seal and smooth rotation with lower torque.
- available working pressure ratings up to 1000 PSI
- available in carbon steel, 316L stainless steel, aluminum, brass and malleable iron

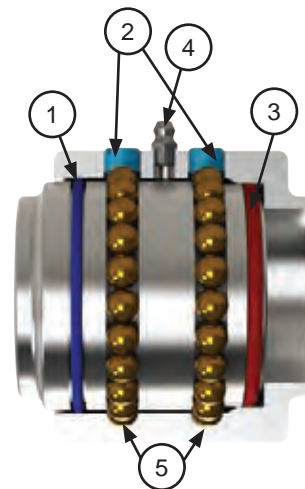

V-ring Parts Identification List

1. body
2. sleeve
3. ball bearings
4. seal retainer
5. V-ring (pressure) seal
6. spring retainer
7. ball retainer screw
8. grease fitting
9. O-ring (dust) seal

V-Ring Features:

- 2" - 12" size range
- spring loaded triple V-ring sealing system ensures a leak-proof seal at either high or low pressure and extends seal life
- available working pressure ratings up to 1000 PSI
- available in carbon steel, 316L stainless steel and limited aluminum

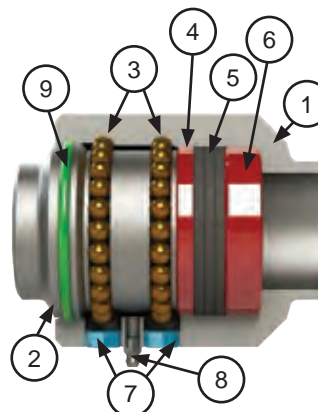

Single Plane Style 20



female NPT x female NPT

Size	Aluminum		Malleable Iron	
	Part #	Price/E	Part #	Price/E
1½"	15020FXFAL00000	\$270.70	15020FXFMI00000	\$342.60
2"	220FXFAL00000	376.15	220FXFMI00000	472.95
3"	320FXFAL00000	435.85	320FXFMI00000	701.10
4"	420FXFAL00000	649.90	---	---

Single Plane Style 30



female NPT x female NPT

Size	Aluminum		Malleable Iron	
	Part #	Price/E	Part #	Price/E
1½"	15030FXFAL00000	\$295.20	15030FXFMI00000	\$374.05
2"	230FXFAL00000	384.15	230FXFMI00000	519.70
3"	330FXFAL00000	519.70	330FXFMI00000	777.55
4"	430FXFAL00000	697.85	---	---

• contact Dixon® at 888.226.4673 for additional sizes, materials and configurations

Swivel Joint Styles Planes of Rotation

Single Plane Style 40



female NPT x female NPT



150# ASA flange x 150# ASA flange

Double Plane Style 50



female NPT x female NPT



150# ASA flange x 150# ASA flange

Double Plane Style 60



female NPT x female NPT



150# ASA flange x 150# ASA flange



Swivel Joint Styles Planes of Rotation

Double Plane Style 70



female NPT x female NPT



150# ASA flange x 150# ASA flange

Triple Plane Style 80



female NPT x female NPT



150# ASA flange x 150# ASA flange

Triple Plane Style 10



female NPT x female NPT

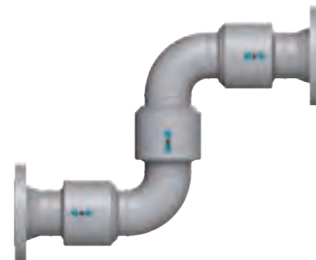

150# ASA flange x 150# ASA flange

Working Pressures

Dixon® swivels are recommended for use at the following maximum Non-Shock Cold Working Pressures (NSCWP) provided in PSI, at ambient temperatures **70°F (21°C)**.

Size	V-ring Carbon Steel CS	O-ring Carbon Steel OC	V-ring Stainless Steel SS	O-ring Stainless Steel OS	Aluminum AL	Brass BR	Malleable Iron MI
1"	---	1000	---	1000	150	---	---
1¼"	---	---	---	---	150	---	---
1½"	---	1000	---	1000	150	300	600
2"	1000	1000	1000	1000	150	300	600
3"	1000	1000	1000	1000	150	300	600
4"	1000	---	1000	---	150	---	---
6"	1000	---	---	---	150	---	---
8"	---	---	---	---	150	---	---

- When using flanged ends, the pressure rating will be reduced to coincide with that of the flange being used. Carbon steel and stainless steel 150# flanges are recommended for use at **275 PSI** maximum at ambient temperature **70°F (21°C)**.
- Lubrication should be performed periodically, depending on service and operating conditions. Twice yearly is normally sufficient.
- All dimensions are approximate. Where critical, contact Dixon® at 888.226.4673

Swivel Ordering Information

- Size
- Style (shape)
- End configuration
- Material
- Maximum working pressure
- Temperature range
- Media: specify product being handled (if chemical, advise concentration)
- Submerged or oxygen service
- If for constant rotation, advise RPM
- If for suction service, advise maximum vacuum in inches of mercury (Hg)

Our Sales and Engineering staff will help you evaluate your swivel application, please call 888.226.4673.

Example: $\frac{2}{[A]}$ $\frac{20}{[B]}$ $\frac{F}{[C]}$ X $\frac{F}{[C]}$ $\frac{CS}{[D]}$ $\frac{0}{[E]}$ $\frac{0}{[F]}$ $\frac{1}{[G]}$ $\frac{0}{[H]}$ $\frac{0}{[I]}$

A Size					
B Style					
C End Connections	W Weld End	F Female NPT	FG 150# ASA Flange	TF Tank Truck Flange	PF 300# ASA Flange (not available in aluminum)
D Material	CS (V-ring) Carbon Steel OC (O-ring) Carbon Steel	SS (V-ring) Stainless Steel OS (O-ring) Stainless Steel	AL Aluminum	BR Brass	MI Malleable Iron
Code	E Pressure Seal	F Dust Seal	G Retainers	H Ball Bearings	I Grease
0	Buna N (standard)	Buna N (standard)	no retainers (O-ring swivel)	carbon steel (Standard)	Lithium
1	FKM	FKM	aluminum (standard in CS V-ring)	440 grade SS	FDA approved/ food grade
2	PTFE	---	PTFE (standard in SS V-ring)	316 grade SS	Silicone (required with EPR seals)
3	Ethylene Propylene	Ethylene Propylene	---	---	---
4	(requires silicone grease)	(requires silicone grease)	---	---	---



The swivel should be packed such that the surfaces coming in contact with the fluid being handled are compatible with that fluid. In a case where the swivel is being used in a submerged service, this would include the dust seals and ball bearings. We always recommend the use of the stainless steel ball bearings when building a swivel for submerged service. Standard carbon steel ball bearings could rust together, making it impossible to disassemble the swivel and may affect operation.

Loading Arm Swivels

Features:

- TTMA loading arm swivel with heavy duty D style shovel handle
- TTMA flanges on both ends
- shovel handle is used to guide the API load coupler onto the adapter on the tank truck
- long radius elbow improves flow into the API load coupler and provides spacing between the load arm and the tank truck
- can be used with flange extensions on page A-31

Size	Description	Aluminum	
		Part #	Price/E
4"	Style 30 short radius, with handle, Buna seals	43HTFXTFAL00000	\$1200.00
	Style 30 short radius, with handle, FKM seals	43HTFXTFAL11000	1230.00
	Style 30 short radius, without handle, Buna seals	430TFXTFAL00000	1150.00
	Style 30 short radius, without handle, FKM seals	430TFXTFAL11000	1280.00
	Style 30 long radius, with handle, Buna seals	43HTFTFLAL00000	1250.00
	Style 30 long radius, with handle, FKM seals	43HTFTFLAL11000	1280.00
	Style 30 long radius, without handle, Buna seals	430FTFTFLAL00000	1200.00
	Style 30 long radius, without handle, FKM seals	430FTFTFLAL11000	1230.00
	Style 40 with handle, Buna seals	44HTFXTFAL00000	1400.00
	Style 40 with handle, FKM seals	44HTFXTFAL11000	1430.00
	Style 40 without handle, Buna seals	440TFXTFAL00000	1350.00
	Style 40 without handle, FKM seals	440TFXTFAL11000	1380.00
	Style 50 with handle, Buna seals	45HTFXTFAL00000	1600.00
	Style 50 with handle, FKM seals	45HTFXTFAL11000	1630.00
	Style 50 without handle, Buna seals	450TFXTFAL00000	1550.00
	Style 50 without handle, FKM seals	450TFXTFAL11000	1580.00

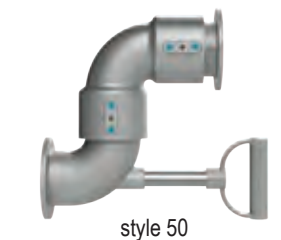
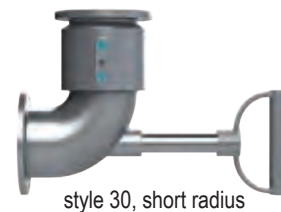

Engineered Fluid
Transfer Couplings



Replacement Parts

Description	Part #	Price/E
4" schedule 80 aluminum nipple	ATN100X7	\$25.00
D style heavy duty shovel handle	100DHAN-AL	50.00
buna seal kit	4RKOBU	38.90
FKM seal kit	4RKOVIVI	60.65



Split Flange Swivels

Applications:

- Used in petroleum, blending plants, petrochemical, refining, mining, distilling, paint plants, farm irrigation and fertilizing, wastewater treatment, food and beverage process equipment and marine

Features:

- bearing pack design allows easy seal change without removing the ball bearings
- simple maintenance: remove one nose piece, replace seal pack, reinstall with little down-time
- instream seal separates wetted area from ball bearings allowing for longer bearing pack life over conventional swivels
- pressure rating: up to **600 PSI**
- temperature: **-40°F to 450°F (-40°C to 232°C)** depending on seal material (with standard seals: **350°F (177°C)**)
- wide set bearing race for higher moment loads
- compact design for low profile applications

Materials:

- bearing pack: through hardened forged high carbon alloy
- material contact surfaces: stainless steel or carbon steel nose pieces

Available options:

- stock end configurations: 150 lb. and 300 lb. flanges, FNPT, butt weld, others per request
- stock seals: Baylast™, FKM, PTFE, others per request
- full penetration weld
- contact Dixon® at 888-226-4673 for additional materials and configurations

Size	Carbon Steel Weld x Weld with Baylast™ Pressure Seals		Carbon Steel Weld x Weld with FKM Pressure Seals		Carbon Steel 150# Flange x 150# Flange with Baylast™ Pressure Seals		Carbon Steel 150# Flange x 150# Flange with FKM Pressure Seals	
	Part #	Price/E	Part #	Price/E	Part #	Price/E	Part #	Price/E
2"	SF220WXWCS00	\$1662.00	SF220WXWCS10	\$1659.76	SF220FGXFGCS00	\$1836.00	SF220FGXFGCS10	\$1833.76
3"	SF320WXWCS00	1971.00	SF320WXWCS10	1967.70	SF320FGXFGCS00	2164.00	SF320FGXFGCS10	2160.71
4"	SF420WXWCS00	2269.00	SF420WXWCS10	2256.05	SF420FGXFGCS00	2497.00	SF420FGXFGCS10	2484.05



NEW

Railroad Tank Car Connections

Features:

- all swivel nuts have standard 5" Railroad Tank Car thread
- supplied with a Buna-N gasket in the threaded end, other gaskets available on page A-51
- also available in other materials and in 2" and 2½" sizes, consult Dixon® for pricing and availability

Style A



Stainless steel railroad tank car connections are not compatible with aluminum and brass.



Male Adapter	Swivel Nut	Elbow	316 Stainless Steel		Aluminum	
			Part #	Price/E	Part #	Price/E
3"	5"	120°	RTCA30	\$815.00	---	---
4"	5"	110°	RTCA40¹	1027.95	ATCA40	\$712.15

¹ parts are produced as a welded fabrication

Style F

Features:

- 4" TTMA flange can be bolted to sight glass; API adapter or other dry disconnect
- supplied with PTFE Buna-N envelope gasket



110° elbow

TTMA Flange	Swivel Nut	Elbow	Aluminum	
			Part #	Price/E
4"	5"	110°	ATCF40¹	\$708.00
	5"	90°	ATCF40-90	975.00

¹ part is produced as a welded fabrication

• For flange dimensions, diagrams and additional information please reference dixonvalve.com.

Style GF

Feature:

- 4" TTMA flange can be bolted to sight glass; API adapter or other dry disconnect



110° elbow

TTMA Flange	Boss-lock™ Coupler	Elbow	Aluminum	
			Part #	Price/E
4"	4"	110°	ATCGF40	\$450.00
	4"	90°	ATCGF40-90	450.00

• For flange dimensions, diagrams and additional information please reference dixonvalve.com.

Screen

Feature:

- stainless steel screen encapsulated in a buna gasket
- for use in Style GF elbows



Size	Hole Size	316L Stainless Steel	
		Part #	Price/E
4"	1"	400-G-BUSS	\$150.00

Style S



Shank Size	Swivel Nut	Elbow	Aluminum	
			Part #	Price/E
4"	5"	110°	ATCS40	\$370.45

Railroad Tank Car Connections

Style T

Male NPT	Swivel Nut	Elbow	Iron		Aluminum	
			Part #	Price/E	Part #	Price/E
3"	5"	120°	TCT30	\$265.00	ATCT30	\$292.00
4"	5"	110°	TCT40	320.00	ATCT40	360.00



Style T



Stainless steel railroad tank car connections are not compatible with aluminum and brass.

Male NPT	Swivel Nut	Elbow	316 Stainless Steel	
			Part #	Price/E
3"	5"	120°	RTCT30	\$665.00
4"	5"	110°	RTCT40	780.00



Dixon® Coupler x Tank Car Thread

Features:

- part is produced as a welded fabrication
- pressure rating is based on the seal of the mating part, see ratings on page D-5
- use Dixon® replacement handles only

Coupler	Male Tank Car Thread	Aluminum	
		Part #	Price/E
4"	5"	400DWX5TC	\$500.00



EZ Boss-Lock™ x Coupler Tank Car Thread

Features:

- part is produced as a welded fabrication
- pressure rating is based on the seal of the mating part, see ratings on page D-5
- use EZ Boss-Lock™ replacement handles only

Coupler	Male Tank Car Thread	Aluminum	
		Part #	Price/E
4"	5"	AD400ALEZMTC	\$575.80



Railroad Unloading Assemblies

Features:

- robust aluminum body construction
- removable, easy carry handle
- safe and reliable - valves will not open unless fittings are properly connected
- multiple configurations available, consult Dixon™ for pricing and availability



Assembly with Mann Tek Dry Disconnect Adapter

Adapter Size	Swivel Nut Size	Aluminum	
		Part #	Price/E
4"	5"	ATC40ASSDDA	\$2347.65

Assembly with API Adapter



Feature:

- stainless steel springs on the adapter and coupler for corrosion resistance

Adapter Size	Swivel Nut Size	Aluminum	
		Part #	Price/E
4"	5"	ATC40ASSAPI	\$1860.90

Dixon® Tank Car Adapters



rocker lug



pin lug



Stainless steel adapters are not compatible with the aluminum and brass adapters.

Features:

- standard 5" Railroad Tank Car thread
- supplied with a Buna-N gasket in the threaded end, see next page for more gaskets

Size	356T6 Aluminum		Brass		Iron		316 Stainless Steel	
	Part #	Price/E	Part #	Price/E	Part #	Price/E	Part #	Price/E
2"	200-TCA-AL	\$121.60	---	---	---	---	200-TCA-SS	\$693.00
3"	300-TCA-AL	105.00	300-TCA-BR	\$350.00	300-TCA-MI	\$257.00	300-TCA-SS	737.40
4"	400-TCA-AL	119.10	400-TCA-BR	420.00	---	---	400-TCA-SS	815.00

Features:

- standard 5" Railroad Tank Car thread
- 45° tank car swivel adapter
- unit has a long handle brass swivel nut and a swivel retaining ring
- supplied with a Buna-N gasket in the threaded end, see next page for more gaskets



Size	356T6 Aluminum	
	Part #	Price/E
4"	40A-45TCAL	\$485.85

Note: 4" hose fittings for railroad tank car unloading can be found on pages C-47 and C-48.

Cam & Groove Railroad Tank Car Gaskets



Old Style

Feature:

- for use with Dixon® fittings

Size	OD	ID	Thick	Leather	
				Part #	Price/E
5"	5¼"	3½"	3/16"	G9	\$15.00



Standard

Feature:

- for use with Dixon® fittings

Size	OD	ID	Thick	Material	Part #	Price/E
5"	5¼"	3⅞"	⅛"	Buna-N	500GTCABU	\$6.55
	5¼"	3⅞"	⅛"	FKM	500GTCAVI	53.50
	5¼"	3⅞"	⅛"	fuel grade Buna	500GTCABF	6.25
	5-5/16"	3⅞"	3/16"	FKM	500GTCAVITHK	32.00

PTFE Envelope

Features:

- for use with Dixon® fittings
- may be too thick for insertion in some older Dixon® fittings

Size	OD	ID	Thick	Material	Part #	Price/E
5"	5¼"	3-13/16"	3/16"	PTFE with Buna-N filler	500GTCATF	\$65.00
	5¼"	3-13/16"	3/16"	PTFE with FKM filler	500GTCATV	112.00

Pin Lug Wrench

Feature:

- used on aluminum and iron tank car nuts

		Iron	
Part #			Price/E
G10			\$115.00



Bronze Sight Flow Indicators

Female NPT x Female NPT

Features:

- verifies flow and monitors color and clarity in fluid lines
- double window snap ring design
- bronze body
- ABS indicator
- tempered soda lime sight glass
- Buna-N seals
- maximum operating pressure: **125 PSI**
- maximum temperature: **200°F (93°C)**
- made in the USA



Size	Overall Length	Width	Height	Bronze		Optional Qty
				Part #	Price/E	
1/2"	3-13/16"	2-7/16"	2-7/16"	SF1631-050	\$379.15	1
3/4"	3-13/16"	2-7/16"	2-7/16"	SF1631-075	405.10	1
1"	4-3/8"	3"	3-1/8"	SF1631-100	514.20	1
1 1/2"	4-5/8"	3-13/16"	4"	SF1631-150	784.25	1
2"	4-5/8"	3-13/16"	4"	SF1631-200	810.25	1

Stainless Steel Sight Flow Indicators

Female NPT x Female NPT

Features:

- verifies flow and monitor color and clarity in fluid lines
- radial sealing method and bolt-on body design provide reliable service with no torquing maintenance required
- white acetal resin, 40% glass filled propeller style indicator is standard and best for observations at a distance or with opaque liquids ¹
- tempered soda lime sight glass ²
- FKM seals are standard ³
- maximum operating pressure: **200 PSI at 150°F (66°C)**
- maximum temperature: **225°F (107°C) at 150 PSI**
- made in the USA
- 150# flanged units and other metals are available, consult Dixon® for price and availability.



1/2"

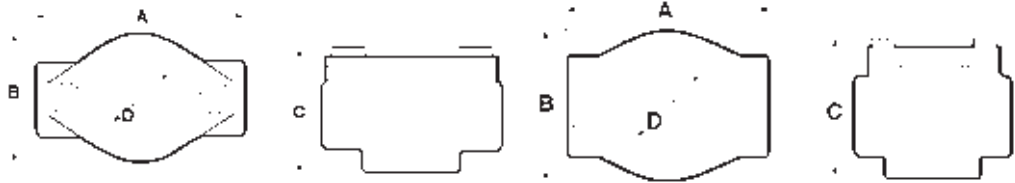

2"

Size	Overall Length A	Width B	Height C	Diameter of Sight Opening D	Stainless Steel		Optional Qty
					Part #	Price/E	
1/2"	3 1/4"	2"	2-3/8"	1 1/8"	SF1471-050	\$794.65	1
3/4"	4 1/4"	2-9/16"	3-1/4"	1 1/2"	SF1471-075	857.00	1
1"	4 1/4"	2-9/16"	3-1/4"	1 1/2"	SF1471-100	1080.30	1
1 1/2"	5 5/8"	3-5/16"	4-5/16"	2"	SF1471-150	1433.50	1
2"	5 5/8"	3-5/16"	4-5/16"	2"	SF1471-200	1687.95	1

¹ Plain, flapper or drip tube style indicators are available as are PTFE indicators, consult Dixon® for price and availability.

² Special units with tempered borosilicate glass are available, consult Dixon® for price and availability.

³ PTFE, EPR and Buna-N seals are available, consult Dixon® for price and availability.

Outalarms	B-2 to B-4
with Capacitance probes	B-2
with high temperature Capacitance probes	B-3
open dome adapter	B-3
outage gauge.....	B-3
gauge rods.....	B-4
 Spillguard™ Monitors.....	 B-5
 Probes	 B-6
 Cables	 B-6





Automated Design Service, Inc. (ADS) is now operating as Dixon® Industrial Fluid Control to manufacture products specifically designed for liquid terminal operations. Our standard product offering is shown on the following pages. However, there are numerous additional applications, materials and custom designs available. Please call **513.874.8499** or **877.582.3569** for technical information or assistance with ordering these products or scan the QR code to access our complete catalog.



ADS Outalarms with Probe

Application:

- specifically designed for liquid terminal operation on batch loading and overflow protection, tank cars, tanks trucks, marine barges, suitable for open and closed dome

Features:

- totally self-contained; no wires, tubing or external power
- rugged weather and corrosion resistant construction
- no moving parts, tip sensitive phase shift™ digital capacitance sensor for conductive and non-conductive fluid
- intrinsically safe design per ANSI/UL913 for Class I, Div I Groups A, B, C and D Hazardous Areas
- requires no calibration or adjustment
- operates up to 2500 hours on a single 9V alkaline battery
- adjustable insertion length through a standard ½" NPT fitting
- high intensity audible and flashing visual outputs
- full, hard graduated laser engraved rod
- fail safe continuous battery monitor goes to alarm state on low battery
- activation point ¼" above liquid surface
- 24", 36", 48" and 60" probe lengths standard, other lengths available
- battery current drain <0.23 ma during standby; <50 ma in alarm state
- horn intensity 101 dB at 2'
- light output 3 each 3000 mcd high intensity flashing LED's
- wetted materials: 316 stainless steel, PTFE standard, other materials available
- pressure rating on standard unit: **50 PSI**, consult Dixon® for applications up to 300 PSI
- optional opto-isolated solid state contact output

ADS Outalarm with Capacitance Probe



Features:

- capacitance Phase Shift probe
- ½" NPT gland standard
- minimum dielectric constant 1.8
- temperature range: **-14°F to 250°F (-26°C to 121°C)**

Probe Length	Part #	Price/E
24"	A100C24A	\$3068.20
36"	A100C36A	3068.20
48"	A100C48A	3068.20
60"	A100C60A	3068.20
72"	A100C72A	3295.45
84"	A100C84A	3295.45
96"	A100C96A	3295.45

ADS Outalarm with High Temperature Capacitance Probe

Features:

- capacitance Phase Shift probe
- 1/2" NPT gland standard
- minimum dielectric constant 1.7
- temperature range: -14°F to 325°F (-26°C to 163°C)

Probe Length	Part #	Price/E
24"	A100HC24A	\$3522.75
36"	A100HC36A	3522.75
48"	A100HC48A	3522.75
60"	A100HC60A	3522.75
72"	A100HC72A	3750.00
84"	A100HC84A	3750.00
96"	A100HC96A	3750.00



ADS Open Dome Adapter



Features:

- flexible design fits most domes
- 1/2 NPT port for Outalarm probes

Stainless Steel Part #	Price/E
A100DA	\$284.10



ADS Outage Gauge



Application:

- used to measure outage of any mobile tanks

Features:

- 1/2" OD rod
- laser engraved scale with 1/4" graduations
- open dome bracket
- overall length: 60"

Stainless Steel Part #	Price/E
A100OGA	\$1500.00



laser engraving closeup





ADS Gauge Rods

Application:

- used to gauge liquid levels in any mobile tank

Features:

- 1/2" x .065 wt hardened 316 stainless steel
- laser engraved scale with 1/4" graduations
- rods come in two sections that screw together at the midpoint
- foot marks inscribed on rod at 1' intervals below the inch mark
- heavy duty plastic handle
- available in 4', 8' and 12' lengths



Length / Ft	316 Stainless Steel Part #	Price/E
4'	ADS04GR	\$909.00
8'	ADS08GR	1060.60
12'	ADS12GR	1363.60



laser engraving closeup

ADS Spillguard™ Monitors

NEW

Application:

- shutdown system for tank cars, tank trucks, barges and ships, suitable for open and closed dome

Features:

- rugged, explosion proof, weather, chemical and corrosion resistant
- LED status lights visible through glass cover
- inserts into tank through standard 1/2" NPT fitting
- probe can be portable or permanently installed in the vessel
- laser engraved graduated rod with 1/4" graduations
- probe-to-controller cable protected by stainless steel interlocking armor sheath and heavy duty latching connectors at both ends
- fail safe design, unit trips in the event of an open or shorted cable or loss of power
- controller housing NEMA 4X, NEMA 7, Explosion Proof, Class I, II, Groups B, C and D
- choice of capacitance, conductivity, ultrasonic, temperature or float sensors
- insertion lengths 4" to 60" standard, other lengths available
- wetted materials: 316 stainless steel and PTFE standard, other materials available
- sensor suitable for Class I, II, III, Div 1, Groups A, B, C and D when used with supplied controller and cable lengths of 10,000' or less
- input power: 120 VAC, 240 VAC or 24 VDC, 2.5 watts
- output relay contacts 2 form C (2PDT) rated 2 amps at 120/240 VAC, 1 form C (SPDT) with optional latching circuit and reset switch
- output relay de-energizes on high level, broken or shorted sensor cables or loss of power
- sensor excitation open circuit voltage 8 VDC, short circuit current 8 MA with built-in FM approved barrier
- probe temperature range: **-14°F to 212°F (-26°C to 100°C)**
- probe pressure rating: **50 PSI** with standard fitting, consult Dixon® for applications up to 300 PSI
- standard cable lengths: 15', 25' and 50', other lengths available
- cable connectors designed for repeated mating meet IP 65 mechanical and environmental specifications
- optional self test feature, tilt and ground verification interlocks and latching circuit available



Description	Part #	Price/E
24 VDC	A210-24	\$2381.80
120 / 240 VAC	A210-120	2268.20
with bypass timer, 24 VAC	A210B-24	2893.20
with bypass timer, 120 / 240 VAC	A210B-120	3006.80



ADS Spillguard™ Probes

Features:

- capacitance Phase Shift probe
- ½" NPT gland standard



with Capacitance Sensor

Probe Length	Part #	Price/E
24"	A200PC24A	\$1545.45
36"	A200PC36A	1545.45
48"	A200PC48A	1545.45
60"	A200PC60A	1545.45
72"	A200PC72A	1772.70
84"	A200PC84A	1772.70
96"	A200PC96A	1772.70

with High Temperature Capacitance Sensor

Probe Length	Part #	Price/E
24"	A200PHC24A	\$2000.00
36"	A200PHC36A	2000.00
48"	A200PHC48A	2000.00
60"	A200PHC60A	2000.00
72"	A200PHC72A	2227.30
84"	A200PHC84A	2227.30
96"	A200PHC96A	2227.30



ADS Spillguard™ Armored Cables

Features:

- 3 pin connector
- stainless steel armored cable
- custom lengths available, call 513.874.8499 or 877.582.3569 for more information



Cable Length	Stainless Steel Part #	Price/E
15'	A200CA3P15	\$613.65
20'	A200CA3P20	700.00
25'	A200CA3P25	786.35
50'	A200CA3P50	1218.20

Boss™ System C-2 to C-12	Holedall™ (cont.) C-16 to C-37
Ground joints C-2 to C-4	Internal swage C-25 to C-30
Complete female C-2	Stems C-25 to C-26
Stems C-2	Ferrules C-26
Wing nuts C-3	Scovill style C-27 to C-28
Knurled nut C-3	API Certified permanently attached C-29 to C-30
Female spuds C-3	Washers C-31
Male spuds C-4	HB coupling expander machine C-31
Double spuds C-4	Permanent pump hose couplings C-31
Boss Holedall™ fittings C-4	Dubl-grip® re-attachable couplings C-32
NPT adapters C-5	CIP internal expansion sanitary style C-33
Wing nut caps C-5	Sanitary style C-33 to C-35
Washer seals C-6 to C-7	Stems C-33 to C-34
Complete female C-6	Threaded hex nuts C-34
Stems C-6	Flow Chief ferrules C-35
Female spuds C-6	Sanitary King Crimp™ stems C-36
Male spud C-7	DIN external crimp stems C-37
Double spuds C-7	Sanitary style crimp ferrules C-37
Seal washers C-7	
Male stems C-8	King Crimp™ C-38 to C-51
LP Boss™ male stems C-9	Crimp working pressure chart C-38
Hose menders C-9	Type C's C-39
Spud x hose shank C-9	Type E's C-40
Clamps C-10 to C-11	Global type C's C-40
Ground joint air hammer C-12	Global type E's C-41
	Boss™ ground joint stems C-41
Boss™ LPS frac fittings ... C-13 to C-16	Sleeves C-42 to C-43
Male/female assemblies C-13	Ferrules C-44 to C-45
Females C-13	Crimp working pressure chart C-46
Males with nut C-14	Nipples C-47
O-ring C-14	Flanged nipples C-48
Short ferrules C-14	Short nipples C-49
One and two piece hammer union nuts C-15	Short ferrules C-49
Hammer union caps and plugs C-15	Large sleeves C-49
One-piece flange adapters C-16	Heavy duty nipples C-50
One-piece 150# flange to weld adapters C-16	Heavy duty ferrules C-51
Holedall™ C-17 to C-37	
Coupling machines C-17	
Recommended working pressure C-18	
External swage C-19 to C-24	
Stems C-20 to C-21	
Flange assemblies C-21	
Female ends C-22	
Uni-range male couplings C-22	
Ferrules C-23 to C-24	

**Features:**

- positive metal-to-polymer seal
- leakproof seal forms when the metal head of the stem makes contact with the patented polymer seat in the spud
- non-metallic polymer seat resists most chemicals found in manufacturing facilities (reference corrosion resistance chart on pages N-10 to N-15)
- recommended for steam service up to **450°F (232°C)**
- easy to seal
- use with Boss™ clamps found on pages C-10 and C-11

BOSS™ Ground Joint Couplings with Female Spud

plated iron / steel

316 stainless steel

brass

Hose Shank x NPT	Plated Steel and / or Iron		316 Stainless Steel		Brass	
	Part #	Price/E	Part #	Price/E	Part #	Price/E
1/4"	GF1 ¹	\$50.45	---	---	---	---
3/8"	GF3 ¹	42.65	---	---	---	---
1/2"	GF6	33.70	---	---	---	---
1/2" x 3/4"	GF26-1	43.65	---	---	---	---
3/4"	GF26	40.95	RGF26	\$219.30	BGF26	\$156.95
1"	GF36	42.25	RGF36	240.70	BGF36	174.30
1 1/4"	GF51	79.55	RGF51	354.75	BGF51	227.60
1 1/2"	GF61	76.70	RGF61	426.15	BGF61	268.50
2"	GF81 ²	94.45	RGF81 ²	560.00	BGF81 ²	437.80
2 1/2"	GF96	215.50	---	---	---	---
3"	GF111	246.40	---	---	---	---
4"	GF141	500.00	---	---	---	---
6"	GF201 ¹	1183.25	---	---	---	---



¹ 1/4", 3/8" and 6" available only with copper seat spuds
² not to be used with #250, #275 or #306 Boss™ clamps

BOSS™ Ground Joint Stems

plated iron / steel

316 stainless steel

brass

Hose Shank x NPT	Plated Steel and / or Iron		Optional Qty	316 Stainless Steel		Brass	
	Part #	Price/E		Part #	Price/E	Part #	Price/E
1/4"	GBA	\$18.75	100	---	---	---	---
3/8"	GCA	8.90	100	---	---	---	---
1/2"	GB1	7.40	100	---	---	---	---
1/2" x 3/4"	GB6-1	17.20	50	---	---	---	---
3/4"	GB6	14.50	50	RGB6	\$78.25	BGB6	\$61.00
1"	GB11	15.20	50	RGB11	98.90	BGB11	56.60
1 1/4"	GB16	23.60	25	RGB16	109.45	BGB16	56.70
1 1/2"	GB21	22.70	25	RGB21	118.45	BGB21	80.00
2"	GB26 ²	26.25	10	RGB26 ¹	173.00	BGB26 ¹	142.00
2 1/2"	GB31	56.85	5	---	---	---	---
3"	GB36 ²	90.00	5	---	---	---	---
4"	GB46	160.60	5	---	---	---	---
6"	GB66	365.00	2	---	---	---	---

¹ not to be used with #250, #275 or #306 Boss™ clamps

² GB26 / GB36 has a machined shank to accept a Boss™ clamp, King Crimp™ sleeve or a ferrule

Please reference dixonvalve.com for an explanation of the Boss™ coupling system.

Boss™ Wing Nuts

Size	Plated Steel and / or Iron		Optional Qty	316 Stainless Steel		Brass	
	Part #	Price/E		Part #	Price/E	Part #	Price/E
¼"	SLS4	\$12.70	100	---	---	---	---
¾"	CB	11.80	100	---	---	---	---
½"	B2	8.05	100	---	---	---	---
¾"	B12	10.55	25	RB12	\$70.00	BB12	\$47.70
1"	B12	10.55	25	RB12	70.00	BB12	47.70
1¼"	B17	19.75	25	RB17	115.30	BB17	83.50
1½"	B17	19.75	25	RB17	115.30	BB17	83.50
2"	B27	31.10	10	RB27	194.60	BB27	155.40
2½"	B32	68.80	5	---	---	---	---
3"	B37	59.30	5	---	---	---	---
4"	B47	168.00	5	---	---	---	---
6"	B67	248.25	2	---	---	---	---



plated iron / steel



316 stainless steel



brass

Boss™ Knurled Nut

Size	Plated Steel and / or Iron		Optional Qty
	Part #	Price/E	
¾" and 1"	KB12	\$15.90	25



Boss™ Ground Joint Female Spuds

Thread	Plated Steel and / or Iron		Optional Qty	316 Stainless Steel		Brass	
	Part #	Price/E		Part #	Price/E	Part #	Price/E
¼"	GBC¹	\$19.00	100	---	---	---	---
¾"	GCC¹	21.95	100	---	---	---	---
½"	GB3	18.25	100	---	---	---	---
¾"	GB8	15.90	50	RGB8	\$71.05	BGB8	\$48.45
1"	GB13	16.50	50	RGB13	71.80	BGB13	70.00
1¼"	GB18	36.20	25	RGB18	130.00	BGB18	89.90
1½"	GB23	34.25	25	RGB23	192.40	BGB23	105.00
2"	GB28	37.10	10	RGB28	192.40	BGB28	140.40
2½"	GB33	89.85	5	---	---	---	---
3"	GB38	97.10	5	---	---	---	---
4"	GB48	171.40	5	---	---	---	---
6"	GB68¹	570.00	2	---	---	---	---

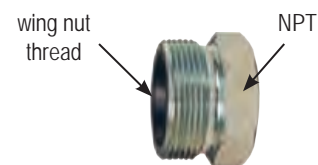

¹ ¼", ¾" and 6" available only with copper seat spuds, all other sizes have polymer seats

Boss™ Ground Joint Male Spuds

Coupling Systems



Thread	Plated Steel		Plated Iron	
	Part #	Price/E	Part #	Price/E
3/8"	GMC¹	\$20.00	---	---
1/2"	GM3	22.90	---	---
3/4"	GM8	21.70	---	---
1"	GM13	22.90	---	---
1 1/4"	---	---	GM18	\$51.85
1 1/2"	---	---	GM23	50.00
2"	---	---	GM28	54.00
2 1/2"	---	---	GM33	128.10
3"	---	---	GM38	134.70

¹ 1/4", 3/8" and 6" available only with copper seat spuds, all other sizes have polymer seats

Boss™ Ground Joint Double Spuds

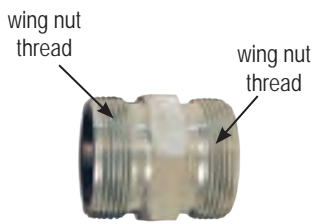

Thread	Plated Steel		Plated Iron	
	Part #	Price/E	Part #	Price/E
1/2"	GDB3	\$36.50	---	---
3/4" and 1"	GDB13	35.40	---	---
1 1/4" and 1 1/2"	---	---	GDB23	\$61.50
2"	---	---	GDB28	66.25
2 1/2"	---	---	GDB33	131.35
3"	---	---	GDB38	137.70

Boss Holedall™ Fittings

Applications:

- designed for air and liquid applications where a permanent, low profile clamping system is desired
- not for steam service

Feature:

- supplied with carbon steel ferrules
- consult Dixon® for swage and/or crimp specifications



Size	Hose OD		Plated Iron / Steel		Stainless Steel	
	From	To	Part #	Price/E	Part #	Price/E
3/4"	1-10/64"	1-14/64"	GF26P1	\$58.15	---	---
	1-15/64"	1-18/64"	GF26P2	58.15	---	---
	1-19/64"	1-22/64"	GF26P3	58.15	---	---
1"	1-30/64"	1-34/64"	GF36P1	61.55	---	---
	1-35/64"	1-38/64"	GF36P2	61.55	---	---
	1-39/64"	1-42/64"	GF36P3	61.55	---	---
1 1/2"	1-58/64"	2"	GF61P1	128.50	RGF61P1	\$440.00
	2-1/64"	2-8/64"	GF61P2	128.50	RGF61P2	440.00
	2-9/64"	2-16/64"	GF61P3	128.50	---	---
2"	2-28/64"	2-40/64"	GF81P1¹	138.60	RGF81P1	580.00
	2-41/64"	2-48/64"	GF81P2¹	138.60	RGF81P2	580.00
	2-49/64"	2-56/64"	GF81P3¹	138.60	---	---
3"	3-30/64"	3-40/64"	GF111P1¹	355.00	---	---
	3-41/64"	3-48/64"	GF111P2¹	355.00	---	---
	3-49/64"	3-56/64"	GF111P3¹	355.00	---	---

¹ 2" and 3" have a machined shank

Boss™ Female NPT Adapters**Features:**

- designed to fit the standard ground joint spuds on page C-3
- supplied with a wing nut, as shown
- for safety tags and safety tape, see page M-10

Size	Plated Steel and / or Iron	
	Part #	Price/E
¾"	GFAS6	\$101.40
1"	GFAS11	110.00
1¼"	GFAS16	125.00
1½"	GFAS21 ¹	157.60
2"	GFAS26	162.00
3"	GFAS36	220.00

NEW¹ part is produced as a welded fabrication**Boss™ Male NPT Adapters**

Size	Plated Steel and / or Iron	
	Part #	Price/E
¾"	GMAS6	\$51.50
1"	GMAS11	53.70
1¼"	GMAS16	74.00
1½"	GMAS21	88.85
2"	GMAS26 ¹	92.50
3"	GMAS36	162.50

NEW¹ uses a special wing nut, part # B27-1**Boss™ Wing Nut Caps****Features:**

- supplied with 12" chain and washer
- for best results, use with washer style spuds and washers on pages C-6 and C-7
- not intended for pressure applications 

Size	Plated Steel and / or Iron		Opt Qty
	Part #	Price/E	
¾" and 1"	B12SC	\$44.60	25
1¼" and 1½"	B17SC	58.50	25
2"	B27SC	82.25	10
3"	B37SC	131.25	5

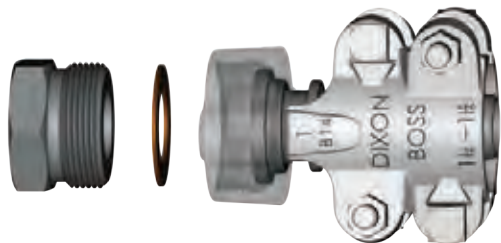

**Features:**

- recommended for steam service up to **450°F (232°C)**
- easy to seal
- Klingersil® C-4401 washer is inserted between the stem and spud
- leakproof seal forms by rotating the wing nut and hammering it tight
- use with Boss™ clamps found on pages C-10 and C-11
- use with wing nuts found on page C-3

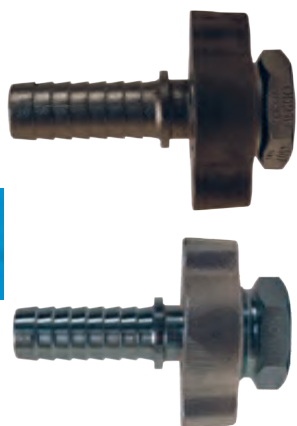
Boss™ Washer Seal Couplings with Female Spud

Hose Shank x NPT	Plated Steel and / or Iron		316 Stainless Steel	
	Part #	Price/E	Part #	Price/E
3/8"	WF3	\$32.80	---	---
1/2"	WF6	32.80	---	---
1/2" x 3/4"	WF26-1	43.70	---	---
3/4"	WF26	39.15	RWF26	\$223.60
1"	WF36	40.10	RWF36	233.15
1 1/4"	WF51	86.55	RWF51	347.30
1 1/2"	WF61	77.40	RWF61	440.40
2"	WF81 ¹	97.20	RWF81 ¹	559.45
2 1/2"	WF96	221.50	---	---
3"	WF111	230.40	---	---

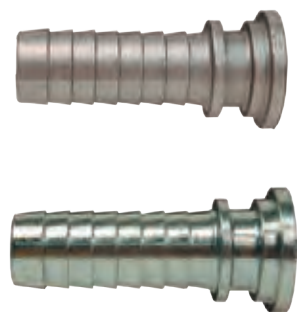

¹ not to be used with #250, #275 or #306 Boss™ clamps

Boss™ Washer Seal Stems

Hose Shank x NPT	Plated Steel and / or Iron		Opt Qty	316 Stainless Steel	
	Part #	Price/E		Part #	Price/E
3/8"	SS337	\$7.45	100	---	---
1/2"	B1	11.75	100	---	---
1/2" x 3/4"	B6-1	19.15	50	---	---
3/4"	B6	14.60	50	RB6	\$76.05
1"	B11	15.75	50	RB11	84.80
1 1/4"	B16	31.00	25	RB16	122.70
1 1/2"	B21	25.90	25	RB21	136.30
2"	B26 ¹	29.70	10	RB26 ¹	177.00
2 1/2"	B31	67.90	5	---	---
3"	B36	80.40	5	---	---



¹ not to be used with #250, #275 or #306 Boss™ clamps

Boss™ Washer Seal Female Spuds

Thread Size	Plated Steel and / or Iron		Opt Qty	316 Stainless Steel	
	Part #	Price/E		Part #	Price/E
3/8"	CC	\$12.85	100	---	---
1/2"	B3	12.20	100	---	---
3/4"	B8	13.05	25	RB8	\$76.60
1"	B13	12.85	50	RB13	77.40
1 1/4"	B18	34.50	25	RB18	108.00
1 1/2"	B23	30.45	25	RB23	187.50
2"	B28	34.95	10	RB28	186.40
2 1/2"	B33	84.00	5	---	---
3"	B38	88.10	5	---	---

Boss™ Washer Seal Male Spuds

Thread	Plated Steel or Iron	
	Part #	Price/E
3/8"	WMC ¹	\$15.20
1/2"	WM3 ¹	26.55
3/4"	WM8 ¹	19.45
1"	WM13 ¹	23.20
1 1/4"	WM18 ²	45.30
1 1/2"	WM23 ²	53.85
2"	WM28 ²	60.00
3"	WM38 ²	130.00

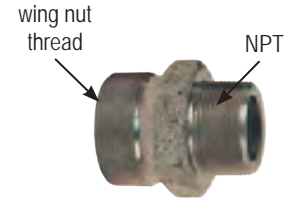
¹ plated steel² plated iron**Boss™ Washer Seal Double Spuds**

Thread	Plated Steel or Iron	
	Part #	Price/E
3/8"	---	---
1/2"	DB3 ¹	\$23.60
3/4"	DB13 ¹	27.90
1"	DB13 ¹	27.90
1 1/4"	DB23 ²	42.30
1 1/2"	DB23 ²	42.30
2"	DB28 ²	59.25
3"	DB38 ²	115.65

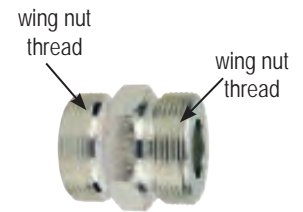
¹ plated steel² plated iron**Boss™ Washer Seal Washers**

Size	Nitrile Rubber Bonded, Non-Asbestos Klingersil® C-4401	
	Part #	Price/E
3/4"	WBC	\$0.70
1/2"	W2	0.80
3/4"	W12	0.95
1"	W12	0.95
1 1/4"	W17	1.30
1 1/2"	W17	1.30
2"	W27	1.45
2 1/2"	W32	1.65
3"	W37	2.60



BOSS™ Male Stems

Features:

- recommended for steam service up to **450°F (232°C)**
- use with Boss™ clamps on pages C-10 and C-11 for safety tags and safety tape see page M-10



plated steel



plated iron



316 stainless



brass

Hose x NPT size	Plated Steel Bar Stock		Opt Qty	Size	Plated Iron		Opt Qty
	Part #	Price/E			Part #	Price/E	
1/4" x 1/8"	MS4X2	\$9.90	100	---	---	---	---
1/4" x 1/4"	MSA	7.85	100	---	---	---	---
1/4" x 3/8"	MSB	8.50	25	---	---	---	---
3/8" x 1/4"	MS6X4	8.00	100	1 1/4"	MS16	\$24.00	20
3/8" x 3/8"	HY3	7.00	100	1 1/2"	MS21	28.15	20
3/8" x 1/2"	MS6X8	11.10	50	2"	MS26	39.00	10
1/2" x 1/4"	MS8X4	7.85	50	2 1/2"	MS31	66.60	5
1/2" x 3/8"	MS8X6	7.85	50	3"	MS36	90.50	5
1/2" x 1/2"	MS1	6.45	50	4"	MS46	153.00	2
1/2" x 3/4"	MS8X12	19.10	25	---	---	---	---
3/4" x 1/2"	MS12X8	14.70	25	---	---	---	---
3/4" x 3/4"	HY6	10.15	50	---	---	---	---
3/4" x 1"	MS12X16	22.00	25	---	---	---	---
1" x 3/4"	MS16X12	22.00	25	---	---	---	---
1" x 1"	MS11	14.35	25	---	---	---	---

Size	316 Stainless		Size	Brass	
	Part #	Price/E		Part #	Price/E
1/2"	RMS1	\$63.55	---	---	---
3/4"	RMS6	62.50	3/4"	BMS6	\$43.25
1"	RMS11	64.00	1"	BMS11	54.95
1 1/4"	RMS16	122.00	1 1/4"	BMS16	74.80
1 1/2"	RMS21	122.50	1 1/2"	BMS21	93.30
2"	RMS26	133.40	2"	BMS26	139.40
2 1/2"	RMS31	250.00	---	---	---
3"	---	---	3"	BMS36	322.50

LP Boss™ Male Stems - Male NPT End

Size	Schedule 40 Plated Steel		Schedule 40 Stainless Steel		Schedule 80 Plated Steel	
	Part #	Price/E	Part #	Price/E	Part #	Price/E
1¼"	LP16	\$63.00	---	---	LP16-80 ¹	\$66.50
1½"	LP21	60.00	---	---	LP21-80 ¹	69.00
2"	LP26	53.20	---	---	LP26-80 ¹	74.25
2½"	LP31	126.50	---	---	---	---
3"	LP36	125.00	RLP36	\$221.40	---	---
4"	LP46	164.00	RLP46	375.00	---	---
6"	LP66	340.00	---	---	---	---



¹ schedule 80 stems meet NFPA 58

LP Boss™ Male Stems - Beveled End

Size	Schedule 40 Unplated Steel	
	Part #	Price/E
2"	LPB26	\$66.90
3"	LPB36	115.40



Boss™ Hose Menders

Features:

- collars designed to engage gripping fingers of Boss™ clamps
- ¾" - 3" plated iron; ½" plated steel

Size	Part #	Price/E	Size	Part#	Price/E
½"	M1	\$10.40	1½"	M21	\$21.35
¾"	M6	18.60	2"	M26	37.35
1"	M11	29.80	2½"	M31	67.00
1¼"	M16	22.20	3"	M36	78.80



Boss™ Spud x Hose Shank

Material:

- seat: polymer

Thread	Steel	
	Part #	Price/E
1"	GH1311	\$38.20
2"	GH2826	79.00



Boss™ Clamps

⚠ WARNING

- The bolts used in the Boss™ interlocking clamps are not standard bolts. They vary from standard bolts in their length, diameter, overall thread length and material hardness. These bolts can be retorqued, but it is **not** recommended that the bolts or clamps be reused, as they are designed for a single bend only. Dixon® recommends using only factory supplied replacement bolts.
- Torque values for clamps are based on dry bolts. The use of lubricant on bolts will adversely effect clamp performance. *Do not lubricate nuts and bolts.*
- For all Bolt Tightening Sequences, please visit dixonvalve.com

Features:

- recommended for steam service up to **450°F (232°C)**
- recommended torque rating in ft. lbs.
- replacement nuts and bolts are available, contact Dixon® for more information

Boss™ Clamp 2 Bolt Type, 2 Gripping Fingers

Hose ID	Hose OD		Zinc Plated Iron		Pkg Qty	Stainless Steel ⁴		Torque ft. lbs. ²	Brass		Torque
	from	to	Part #	Price/E		Part #	Price/E		Part #	Price/E	
¼"	36/64"	42/64"	BD³	\$9.05	100	---	---	6	---	---	---
⅜"	44/64"	56/64"	CD³	8.95	100	---	---	6	---	---	---
½"	52/64"	60/64"	DD³	9.45	100	---	---	6	---	---	---
½"	60/64"	1-4/64"	B4³	8.15	25	RB4	\$138.40	12	BB4	\$31.75	10
½"	1-4/64"	1-12/64"	B5	10.50	25	---	---	12	---	---	---
¾"	1-10/64"	1-20/64"	BU9³	10.25	50	RBU9	184.00	21	BBU9	46.50	18
¾"	1-20/64"	1-32/64"	B9	12.05	25	RB9	197.80	21	---	---	---
¾"	1-32/64"	1-44/64"	B10³	13.25	25	---	---	21	---	---	---

Boss™ Clamp 4 Bolt Type, 2 Gripping Fingers

Hose ID	Hose OD		Zinc Plated Iron		Pkg Qty	Stainless Steel ⁴		Torque ² ft. lbs.	Brass		Torque
	from	to	Part #	Price/E		Part #	Price/E		Part #	Price/E	
1"	1-34/64"	1-46/64"	BU14	\$19.85	25	RBU14	\$192.40	21	BBU14	\$91.80	18
1"	1-44/64"	1-60/64"	B14	20.30	25	RB14	192.40	21	BB14	110.30	18
1"	1-60/64"	2-8/64"	B15	23.25	20	---	---	21	---	---	---
1¼"	1-32/64"	1-50/64"	BU18	32.20	20	---	---	40	---	---	---
1¼"	1-50/64"	2-6/64"	BU19	35.80	10	---	---	40	---	---	---
1¼"	2-8/64"	2-24/64"	B19	30.90	10	RB19	210.00	40	---	---	---
1½"	1-52/64"	2"	BU22	36.90	10	---	---	40	---	---	---
1½"	2"	2-14/64"	B22	34.40	10	---	---	40	---	---	---
1½"	2-12/64"	2-24/64"	BU24	30.20	10	RBU24	215.00	40	---	---	---
1½"	2-24/64"	2-36/64"	B24	28.85	10	RB24	204.00	40	---	---	---
1½"	2-36/64"	2-48/64"	B25	32.30	10	---	---	40	---	---	---
2"	2-22/64"	2-34/64"	BU28	41.10	9	---	---	60	---	---	---
2"	2-32/64"	2-50/64"	BU29	37.30	10	RBU29	295.00	60	BBU29¹	173.05	40
2"	2-48/64"	3-4/64"	B29	41.10	10	RB29	309.00	60	---	---	---
2"	3-6/64"	3-28/64"	B30	63.60	5	---	---	60	---	---	---
2½"	3-6/64"	3-28/64"	BU34	66.80	5	---	---	60	---	---	---
2½"	3-32/64"	3-60/64"	B34	86.35	5	---	---	150	---	---	---
3"	3-32/64"	3-60/64"	BU35	97.25	5	RBU35	461.70	150	---	---	---
3"	3-52/64"	4-4/64"	B35	92.30	5	---	---	---	---	---	---
3"	4-4/64"	4-28/64"	B39	119.00	5	---	---	200	---	---	---

¹ will become obsolete as inventory is depleted

² torque applies to plated iron and stainless steel clamps

³ global investment cast carbon steel

⁴ When installing stainless steel bolts and nuts, the use of anti-seize or anti-galling lubricant is advised. A light coat is required on the bolt threads to prevent thread galling and artificial torque reading.

Boss™ Clamps

⚠ WARNING

- The bolts used in the Boss™ interlocking clamps are not standard bolts. They vary from standard bolts in their length, diameter, overall thread length and material hardness. These bolts can be retorqued, but it is **not** recommended that the bolts or clamps be reused, as they are designed for a single bend only. Dixon® recommends using only factory supplied replacement bolts.
- Torque values for clamps are based on dry bolts. The use of lubricant on bolts will adversely effect clamp performance. *Do not lubricate nuts and bolts.*

Features:

- recommended for steam service up to **450°F (232°C)**
- recommended torque rating in ft. lbs.
- replacement nuts and bolts are available, contact Dixon® for more information

Boss™ Clamp 4 Bolt Type, 4 Gripping Fingers

Hose ID	Hose OD		Zinc Plated Iron		Optional Qty	Torque Ft. Lbs.
	from	to	Part #	Price/E		
½"	58/64"	1-2/64"	968	\$14.90	50	6
1"	1-26/64"	1-36/64"	156	20.35	20	21
1¼"	1-44/64"	1-56/64"	187	29.50	10	21
1¼"	1-56/64"	2-4/64"	206	25.70	20	21
1½"	2"	2-8/64"	212	35.25	10	21
1½"	2-4/64"	2-16/64"	225	37.90	10	40
2"	2-16/64"	2-32/64"	250 ¹	39.40	10	40
2"	2-32/64"	2-48/64"	275 ¹	42.25	10	40
2"	2-48/64"	3-4/64"	306 ¹	53.80	5	60
2½"	3-4/64"	3-32/64"	350	53.30	5	60
3"	3-32/64"	3-48/64"	375	67.25	5	60
3"	3-48/64"	4"	401	111.00	5	150
3"	4"	4-12/64"	418	125.45	2	200
3"	4-12/64"	4-32/64"	450	124.40	2	200

¹ not to be used with GF81, GB26, WF81, B26, RGF81, RGB26, BGF81, BGB26, RWF81, RB26

**Boss™ Clamp 6 Bolt Type, 3 Gripping Fingers**

Hose ID	Hose OD		Zinc Plated Iron		Optional Qty	Torque Ft. Lbs.
	from	to	Part #	Price/E		
3"	4-16/64"	4-52/64"	BS39	\$223.85	2	150
4"	4-40/64"	5"	B45	224.00	3	150
4"	4-56/64"	5-16/64"	BS49	339.60	2	200
4"	5-16/64"	5-38/64"	BU49	412.00	2	200
4"	5-34/64"	5-60/64"	B49	453.00	2	200

**Boss™ Clamp 6 Bolt Type, 6 Gripping Fingers**

Hose ID	Hose OD		Zinc Plated Iron		Optional Qty	Torque Ft. Lbs.
	from	to	Part #	Price/E		
6"	6-56/64"	7-24/64"	750	\$419.00	1	200
6"	7-32/64"	8"	850	420.00	1	200



Ground Joint Air Hammer Couplings with Female Spud

Features:

- rounded steel head of stem fits concave inserts in spuds for superior sealing
- metal-to-metal copper seat seal
- for use with Boss™ clamps on page C-10 and C-11



Style	NPT Size	Plated Steel / Iron	
		Part #	Price/E
Compact	1/2"	GDF6	\$46.50
	3/4"	GDF8	48.65
Heavy Duty	3/4"	GDF10	66.60
	1"	GDF12	54.85

Ground Joint Air Hammer Stems



Style	Hose ID	Plated Steel	
		Part #	Price/E
Compact	1/2"	GBA45	\$13.65
	3/4"	GBA46	13.80
Heavy Duty	3/4"	GBB18	23.35
	1"	GBB11	17.40

Ground Joint Air Hammer Wing Nuts



Style	Coarse Nut Thread	Iron	
		Part #	Price/E
Compact	1-31/64" OD x 8 TPI	J47	\$12.50
		J47	12.50
Heavy Duty	1-47/64" OD x 8 TPI	DLB12	16.00
		DLB12	16.00

Ground Joint Air Hammer Female Spuds



Style	NPT Size	Coarse Nut Thread	Plated Steel w/ Copper seat	
			Part #	Price/E
Compact	1/2"	1-31/64" OD x 8 TPI	GJ65	\$20.35
	3/4"		GJ55	23.60
Heavy Duty	3/4"	1-47/64" OD x 8 TPI	GDL8	27.25
	1"		GDL13	22.70

Ground Joint Air Hammer Male Spuds



Style	Hose ID and NPT Sizes	Coarse Nut Thread	Plated Steel w/ Copper seat	
			Part #	Price/E
Compact	1/2"	1-31/64" OD x 8 TPI	GJ60	\$27.40
	3/4"		GJ50	25.10
Heavy Duty	3/4"	1-47/64" OD x 8 TPI	GDL7	33.80
	1"		GDL10	30.55

Ground Joint Air Hammer Double Spuds



Style	Coarse Nut Thread	Plated Steel w/ Copper seat	
		Part #	Price/E
Compact	1-31/64" OD x 8 TPI	GJ75	\$32.50
		GJ75	32.50
Heavy Duty	1-47/64" OD x 8 TPI	GDL25	34.80
		GDL25	34.80

Boss™ LPS Fittings

Application:

- used in the fast paced transfer of water, chemicals and sand slurry to a hydraulic fracturing site

Features:

- one-piece stem design eliminates the leak path common with two-piece threaded systems
- interchangeable with current fittings; phase them into your operation 
- designed to work with Dixon® King Crimp™ sleeves or ferrules.
- 400 PSI** working pressure at **70°F (21°C)** for 3" and 4" sizes; 4:1 safety factor (SF) ¹
- 150 PSI** working pressure at **70°F (21°C)** for 6" size; 4:1 safety factor (SF)
- 150 PSI** working pressure at **70°F (21°C)** for 8" size; 3:1 safety factor (SF)

¹ 400 PSI working pressure with a minimum 4:1 safety factor (*hose burst: hose working pressure*) is only achieved with:

- 3" size uses standard crimp ferrules
- 4" size requires heavy duty (HD) crimp ferrules, CF400-6CSHD through CF400-16CSHD and heavy duty stems

Note: Water and petroleum transfer hoses rated from 100 to 300 PSI WP (4:1 SF) have excellent test results with the standard King Crimp™ ferrules CF400-xxCS.

Materials:

- frac fittings: machined iron to ASTM standards; all stems zinc plated
- male 3", 4" and 6" NPT fittings are schedule 80 pipe; 8" NPT fittings are schedule 40 pipe; all sizes meet ASTM standards
- nut: forged steel meeting AISI standards

Dixon® Complete Male/Female Assembly Frac Fittings

Size	Figure	Part #	Price/E
3"	100	<i>HUMF100300CS</i>	\$430.00
	206	<i>HUMF206300CS</i>	430.00
4"	100	<i>HUMF100400CS</i>	486.50
	206	<i>HUMF206400CS</i>	486.50
6"	100	<i>HUMF100600CS</i>	1100.50
	206	<i>HUMF206600CS</i>	1100.50
8"	100	<i>HUMF100800CS</i>	1283.70
	206	<i>HUMF206800CS</i>	1283.70



Dixon® Female Frac Fittings

Size	Figure	Part #	Price/E
3"	100	<i>HUF100300CS</i>	\$180.00
	206	<i>HUF206300CS</i>	180.00
4"	100	<i>HUF100400CS</i>	186.30
	206	<i>HUF206400CS</i>	186.30
6"	100	<i>HUFALL600CS</i> ¹	461.00
	206		
8"	100	<i>HUFALL800CS</i> ¹	539.00
	206		



¹ meets both figure 100 and 206 specifications



3" and 4" male



6" and 8" male

Dixon® Male Frac Fittings with Nut

Size	Figure	Part #	Price/E
3"	100	HUM100300CS	\$250.00
	206	HUM206300CS ¹	250.00
4"	100	HUM100400CS	300.00
	206	HUM206400CS ¹	300.00
6"	100	HUM100600CS	639.50
	206	HUM206600CS ¹	639.50
8"	100	HUM100800CS	744.70
	206	HUM206800CS ¹	744.70

¹ comes with nut and O-ring

Dixon® Frac Fitting O-rings

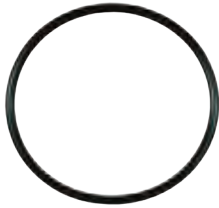

Size	Figure	Buna-N	
		Part #	Price/E
3"	206	O238BU	\$2.00
4"	206	O347BU	1.35
6"	206	O440BU	2.85
8"	206	O447BU	3.75

King Crimp™ Style Short Frac Ferrules



Hose ID	Hose OD		Ferrule Wall Thickness	Ferrule ID	Ferrule Overall Length	Carbon Steel	
	From	To				Part #	Price
8"	8-29/64"	8-36/64"	.120"	8.625"	4.25"	CFS800-1CS	\$133.00
	8-37/64"	8-44/64"	.120"	8.750"	4.25"	CFS800-2CS	133.00
	8-45/64"	8-52/64"	.120"	8.875"	4.25"	CFS800-3CS	133.00
	8-53/64"	8-60/64"	.120"	9.000"	4.25"	CFS800-4CS	133.00
	8-61/64"	9-4/64"	.120"	9.125"	4.25"	CFS800-5CS	133.00
	9-5/64"	9-12/64"	.120"	9.250"	4.25"	CFS800-6CS	133.00
	9-13/64"	9-20/64"	.120"	9.375"	4.25"	CFS800-7CS	133.00
	9-21/64"	9-28/64"	.120"	9.500"	4.25"	CFS800-8CS	133.00

Dixon® One-Piece Hammer Union Nuts

Features:

- long lasting and dependable nut
- all nuts are interchangeable with reliable brands
- cold working pressure: **2,000 PSI**
- 6" and 8" sizes have 4 lug design for more surface area to hammer

Size	Figure	Forged Steel AISI Standards	
		Part #	Price/E
3"	100	HU100300N	\$70.00
	206	HU206300N	70.00
4"	100	HU100400N	112.00
	206	HU206400N	112.00
6"	100	HU100600N	178.50
	206	HU206600N	178.50
8"	100	HU100800N	205.70
	206	HU206800N	205.70



3" and 4"



6" and 8"

Dixon® Two-Piece Hammer Union Nuts

Applications:

- replacement for damaged hammer union nuts
- used with male one-piece flange adapters

Features:

- lug design provides enlarged surface area to hammer
- repair nut is pinned and bolted for perfect alignment
- nut can be installed on pre-existing hammer union assembly
- cold working pressure: **2,000 PSI**
- 4" Figure 200/206 nut is interchangeable with reliable brands
- 6" and 8" Figure 100/200/206 nuts are interchangeable with reliable brands
- available in other series and sizes, contact Dixon®

Dixon® recommends using Loctite® Threadlocker Red 271™ when bolting together two-piece hammer union nuts to ensure that bolts do not loosen when in service. Option two is to weld the seams of the split nut. Bolt torque recommendation is 60 foot pounds. 

Size	Figure	Forged Steel AISI Standards	
		Part #	Price/E
4"	split nut, figure 200/206, blue (includes bolts)	HU200400RN	\$138.05
5"	split nut, suction and discharge, black	HUS500RN	255.00
6"	split nut, figure 100, black (includes bolts)	HU100600RN	282.00
	split nut, figure 200/206, blue (includes bolts)	HU200600RN	282.00
8"	split nut, figure 100, black (includes bolts)	HU100800RN	304.00
	split nut, figure 200/206, blue (includes bolts)	HU200800RN	304.00



figure 200 / 206



figure 100

Hammer Union Caps and Plugs

Application:

- Prevents leakage of hydraulic fracturing fluids from hammer union connections used on manifolds and hose assemblies. Hammer union caps and plugs can be used in pressurized service or as dust caps/plugs on site or when transferring equipment.

Features:

- forged steel construction ensures longevity, reliability and performance
- caps are designed with larger lugs for easier installation and disassembling and include a threaded bolt hole for attaching chain or cable
- plugs are designed with larger handle for easier installation and disassembling and include a handle hole to attach chain or cable
- forged steel meets AISI standards

Size	Description	Forged Steel	
		Part #	Price/E
4"	hammer union cap	HUC207400	\$192.60
	hammer union plug	HUP207400	192.60
	O-ring (Buna-N)	O429BU	2.00



cap



plug



male adapter x flange with hammer union nut



female adapter x flange



male adapter x 45° flange with hammer union nut

Dixon® One-Piece Flange Adapters

Application:

- used in the transfer of water, brine, water-based chemicals, water-based acids, and gelatinous proppant (sand) slurry used at hydraulic fracturing sites
- use with **HU200400RN** two-piece nut

Features:

- flange x female or male hammer union straights (standard or short length)
- 45° elbows in female and male (flange x hammer union)
- no welds or pipe threads to deteriorate and cause premature leakage
- two-piece nut is pinned and bolted for perfect alignment
- all 4" Figure 206 threads are interchangeable with other reliable brands
- 125# flange match the bolt pattern of 150# flange
- iron adapters meet ASTM standards
- forged steel nuts meet AISI standards

Size	Description	Overall Length	Iron	
			Part #	Price/E
4"	female hammer union x 125# flange	5-1/8"	HUF206400FLG	\$271.50
	female hammer union x 125# flange short	3"	HUF206400FLG-ST	252.00
	female hammer union x 125# flange 45° elbow	10-31/32"	HUF206400FLG-45	392.50
	male hammer union x 125# flange includes nut and Buna-N O-ring	5-9/16" (with nut)	HUM206400FLG	397.00
	male hammer union x 125# flange short includes nut and Buna-N O-ring	3-13/32"	HUM206400FLG-ST	377.50
	male hammer union x 125# flange 45° elbow includes nut and Buna-N O-ring	12-1/32" (with nut)	HUM206400FLG-45	520.90
	O-ring (Buna-N)	---	O347BU	1.35

- For flange dimensions, diagrams and additional information please reference dixonvalve.com.

Dixon® One-Piece 150# Flange to Weld Adapters

Application:

- used on a 12" pipe manifold to transfer water, brine, water-based chemicals, water-based acids or gelatinous proppant (sand) slurry at hydraulic fracturing sites

Features:

- no welds or pipe threads to deteriorate and cause premature leakage
- easy to weld to 12" pipe manifolds
- formed butt weld provides accurate alignment
- 4" 150 lb. flange is compatible with other reliable brands
- material meets ASTM standards



10½"

Size	Description	Weldable Cast Steel	
		Part #	Price/E
4"	150# flange x weld adapter, vertical	WA4FL12X750-1	\$680.00
	150# flange x weld adapter, offset	WA4FL12X750-2	680.00
	150# flange x weld adapter, vertical	WA4FL12X1050-1	815.00
	150# flange x weld adapter, offset	WA4FL12X1050-2	815.00

Vertical Pattern

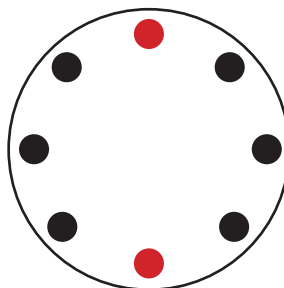

Offset Pattern

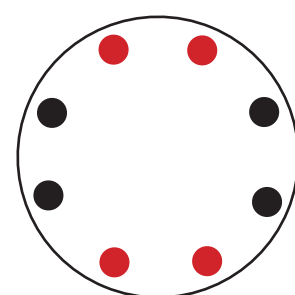

- For flange dimensions, diagrams and additional information please reference dixonvalve.com.

Holedall™ Coupling Machines

Rams, are powerful finely engineered machines designed specifically to externally swage and internally expand Holedall™ couplings by hydraulic pressure securely attaching Holedall™ couplings to hose. Since each ram generates all the hydraulic pressure required to attach the Holedall™ coupling, one person can easily operate the equipment.

15 Ton Ram



Features:

- for internally expanded couplings only
- can expand 1" through 3" steel fittings and 5/8" through 4" brass Holedall™ Petroleum fittings
- produces up to 10,000 PSI, for up to 15 tons of ram force
- bench mounted model (optional stand available)
- motor: ½ h.p., 115 volt, 60 cycle, single phase with foot pedal

100 Ton Ram



Features:

- for externally swaging Holedall™ fittings to hose, sizes 1¼" through 10" ID
- optional accessories allow the ram to be used for internally expanded couplings on hose from 1" through 6"
- capable of producing up to 100 tons of ram force
- motor: 1½ h.p., 115 volt, 60 cycle, single phase motor is standard with remote, (220/440 volt motors are available)

25 Ton Ram



Features:

- can externally swage ¼" through 4" ID hose and internally expand 5/8" through 4" ID hose with proper equipment
- produces up to 10,000 PSI of line pressure for up to 25 tons of ram force
- free standing model
- high speed pump kit option is available
- motor is ½ h.p., 115 volt 60 cycle, single phase with foot pedal

350 Ton Ram

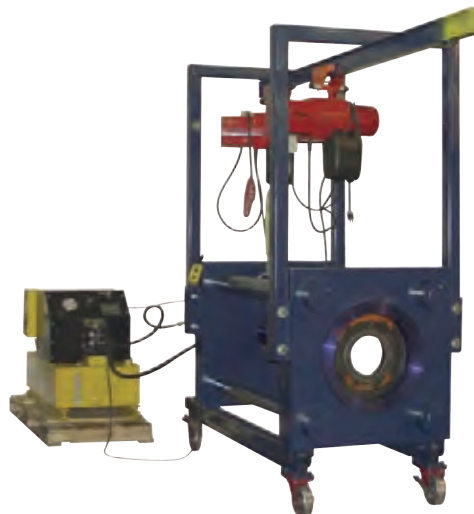

Features:

- for externally swaging Holedall™ and Rotary fittings
- produces up to 354 tons of ram force for swaging
- 14" 150 lb. flange will fit through the bed plate
- ram has 36" of stroke
- motor: 12½ h.p., 230 volt, 60Hz, 3 phase motor is standard with remote

50 Ton Ram



Features:

- can externally swage 1¼" through 6" ID hose and internally expand 1" through 6" ID hose with proper equipment
- produces up to 10,000 PSI, for up to 50 tons of ram force
- bench mounted model (optional stand available)
- motor is 1½ h.p., 115 volt, 60 cycle, single phase, standard with remote, (220/440 volt motors are available)

⚠ All Rams require dies of the proper size to reduce the ferrule to the proper diameter for a good grip on the hose. Pushers of the proper size must be used on the end of the Ram to push the Holedall™ fitting through the die. Die and pusher selection depends on the sizes and types of hoses being coupled. Ferrule recommendations and a Die Chart are available upon request. Consult Dixon® for specific details.

Recommended Working Pressures

WARNING

Holedall™ couplings, regardless of coupling style, are never to be used for steam service at any pressure. Holedall™ fittings listed below are not to be used with cable reinforced high-pressure hose, 4 or 6 braid wire hydraulic hose or any other service not listed in recommendations. In addition, Internally Expanded Holedall™ couplings are not to be used with plastic lined chemical hose. Consult Dixon® for recommendations on usage.

Holedall™ couplings (Externally Swaged), to perform satisfactorily, must be applied properly in accordance with Dixon® assembly procedures, using the correct die and ferrule for that particular hose end OD. The Dixon® Die and Ferrule Recommendation Guide is to be used to select correct dies and ferrules. If you do not have the updated Die and Ferrule Recommendation Guide, consult Dixon®. Strict adherence to ferrule OD range (Internally Expanded) for each hose end to be assembled is essential for satisfactory performance.

Note: Hose service working pressure (including surges and spikes) is never to exceed the maximum recommended working pressure for the fitting (reference chart below)². Media being transported through the hose should be compatible with the stem material. Compatibility of ferrule material with the environment in which it will be used is recommended. Consult the Compatibility Chart on dixonvalve.com or contact Dixon® for material compatibility. For applications other than the ones listed, please consult Dixon®.

Externally Swaged

Internally Expanded

Size	Standard Fittings ¹	Long Style Fittings ¹	Light Duty Fittings		Cam and Groove ¹	Holedall™ DIN Crimp Stems ¹	Internally Expanded ¹	Flow Chief / Crimp Sanitary Fittings ¹
			NO Notched Fittings ¹	NOS Notched Short Fittings ¹				
			TM, TP, TG, RN•••NO	RST•••NOS, STC•••NOS, GAS••••NOS				
	TM, TP, TG, TMR, TPR, TGR	TML, TPL, TGL	TM, TP, TG, RN•••NO	RST•••NOS, STC•••NOS, GAS••••NOS		HA••••	IXM, IXV, IXH	IXSE, IXFS, IXMS, CSSR
3/4"	---	---	---	---	---	---	---	---
1"	---	---	---	---	250	---	---	---
1 1/4"	600	1,000	350	---	---	---	800	---
1 3/8"	---	---	---	---	---	---	---	---
1 1/2"	600	1,000	350	250	250	145	800	250
2"	600	1,000	350	250	250	145	800	250
2 1/2"	600	1,000	250	---	150	---	600	250
3"	600	1,000	250	250	125	145	600 ³	250
4"	500	850	250	⁴	100	---	500 ³	200
5"	450	750	---	---	---	---	---	---
6"	400	700	---	---	---	---	400	---
8"	350	600	---	---	---	---	---	---
10"	300	550	---	---	---	---	---	---

¹ maximum recommended working pressures, in PSI, given at 70°F ambient temperature

² The assembly's (hose + coupling) maximum working pressure is the lesser of:

- 1) The hose rated working pressure, or
- 2) The coupling rated working pressure

³ For hoses which use IXF48-3 to IXF48-5 and IXF64-2 to IXF64-5, consult Dixon® for working pressures. See notes below for specific recommendations.

⁴ Contact Dixon® for pressure recommendations

Standard Fittings

Recommended for use on most one and two wire braid reinforced hoses, fiber reinforced (braided or spiraled) with or without helical wire such as: oil suction and discharge hose, barge and dock loading and unloading hose as well as LP gas hose, anhydrous ammonia hose, acid chemical hose and high pressure air and water hose.

Long Style Fittings

Recommended for use on hose as listed under standard fittings where additional retention is required due to higher working pressures or end pull. Consult maximum working pressure chart or call Dixon®.

Light Duty Fittings

Recommended for use in the same applications as standard fittings above where lower working pressures are encountered. Consult maximum working pressure chart or consult Dixon®.

Internally Expanded Fittings

Recommended for concrete placement, grout and plaster, food, dairy, pharmaceutical as well as other applications where increased flow capacity is important. Consult maximum working pressure chart or call Dixon® for additional application and working pressure information.

Holedall™ External Swage Coupling System

The Holedall™ coupling system provides outstanding strength, durability and safety.

The Holedall™ system is a method of attaching couplings to hose utilizing a progressive swage. The patented Holedall™ couplings include a Holedall™ stem and a specially engineered ferrule. The hydraulic swaging of the coupling to the hose is accomplished by pushing the ferrule through a die which reduces the ferrule OD, thus providing a 360° uninterrupted compression band around the hose.

A hydraulic ram is the only piece of machinery necessary to accomplish the coupling. Available in five different sizes - 15, 25, 50, 100 and 350 ton see page C-17 - these rams will accommodate dies and pushers of various sizes so that hoses up to 10" in diameter may be coupled.

This multi-purpose, high pressure coupling system requires no bolts and results in a clean coupling with no protrusions. The swaging operation is fast and hose of various lengths and different styles can be coupled. Ease of operation, flexibility and economy make the Holedall™ method an unequalled assembly system.

Features:

- provides long-lasting efficiency and safety
- lightweight coupling consisting of ferrule and stem
- streamlined, no protrusions to snag on equipment
- available in stainless steel and carbon steel
- available in multiple configurations: pipe thread, plain end, grooved or flanged ends

Holedall™ stems and ferrules are specifically designed to be used together as a coupling system.

Due to differences in dimensions and tolerances, for safety reasons, do not use other manufacturer's stems or ferrules with Holedall™ products.



do not use wrench or vice on ferrule

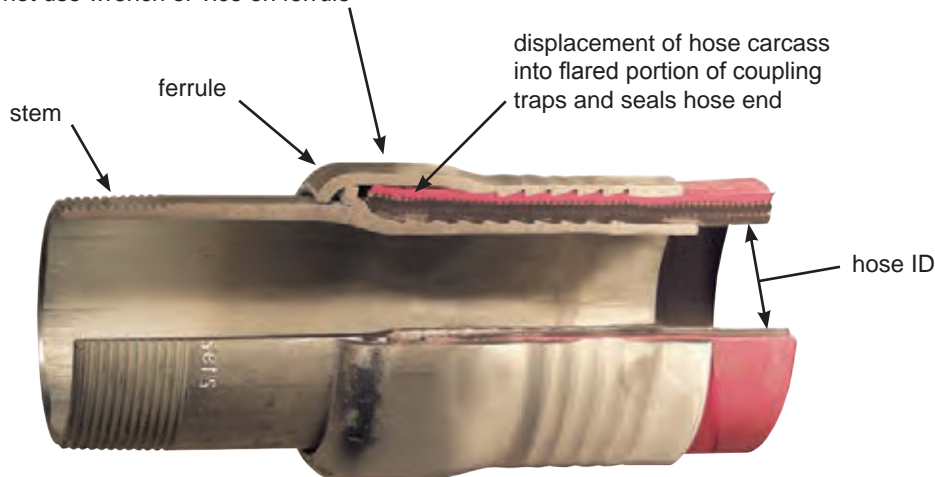

cross-section of Holedall™ externally swaged assembly

External Swage Stems - Male NPT End Tubular Type

Features:

- designed for hose ID's 1¼" - 10", ferrule size depends on the hose OD, refer to page C-23 to select the correct ferrule
- for higher working pressure applications use long style stems and ferrules



Hose ID	Plated Carbon Steel		316 Stainless		Long Style Carbon Steel	
	Part #	Price/E	Part #	Price/E	Part #	Price/E
1¼"	TM20	\$48.20	TMR20	\$75.20	TML20	\$58.00
1½"	TM24	55.00	TMR24	73.85	TML24	65.90
2"	TM32	40.80	TMR32	83.40	TML32	57.10
2½"	TM40	74.90	TMR40	201.00	TML40	83.00
3"	TM48	70.00	TMR48	182.00	TML48	94.75
4"	TM64	87.50	TMR64	288.20	TML64	140.00
5"	TM80	241.00	---	---	TML80	400.00
6"	TM96	220.00	TMR96	705.00	TML96	341.00
	TMR96-42	705.00	---	---	---	---
8"	TM128	258.50	---	---	TML128	371.00
	TM160	557.75	---	---	TML160	680.00

External Swage Stems - Beveled End for Welding



Hose ID	Unplated Carbon Steel		316 Stainless Steel		Long Style Unplated Carbon Steel	
	Part #	Price/E	Part #	Price/E	Part #	Price/E
1¼"	TP20	\$48.20	---	---	TPL20	\$62.00
1½"	TP24	55.00	---	---	TPL24	67.20
2"	TP32	40.80	TPR32	\$113.00	TPL32	57.10
2½"	TP40	74.90	---	---	TPL40	94.75
3"	TP48	70.00	TPR48	210.00	TPL48	94.75
4"	TP64	87.50	TPR64	320.00	TPL64	140.00
5"	TP80	241.00	---	---	TPL80	341.00
6"	TP96	220.00	---	---	TPL96	341.00
8"	TP128	258.50	---	---	TPL128	371.00
10"	TP160	580.00	---	---	TPL160	680.00

External Swage Stems - Grooved End



Hose ID	Plated Carbon Steel		316 Stainless		Long Style Plated Carbon Steel	
	Part #	Price/E	Part #	Price/E	Part #	Price/E
1¼"	TG20	\$48.20	---	---	TGL20	POR
1½"	TG24	55.00	TGR24	\$72.40	TGL24	POR
2"	TG32	53.80	TGR32	83.40	TGL32	POR
2½"	TG40	85.00	TGR40	201.00	TGL40	POR
3"	TG48	81.10	TGR48	182.00	TGL48	POR
4"	TG64	93.00	TGR64	302.60	TGL64	145.45
5"	TG80	241.00	---	---	TGL80	POR
6"	TG96	220.00	---	---	TGL96	POR
8"	TG128	258.50	---	---	TGL128	POR
10"	TG160	580.00	---	---	TGL160	POR

Special Holedall™ Stems

Hose ID	Material	Thread	Part #	Price/E
4"	carbon steel	NPT	TM64-42 ¹	\$103.00
4"	long carbon steel	NPT	TML64-42 ²	140.00
6"	unplated carbon steel	NPT	TM96-42 ³	220.00
6"	316 stainless	NPT	TMR96-42 ³	705.00
6"	long carbon steel	NPT	TML96-42 ³	341.00
6"	unplated carbon steel	beveled	TP96-42 ³	220.00
6"	316 stainless	beveled	TPR96-42 ³	POR
6"	long carbon steel	grooved	TGL96-42 ³	POR
6"	carbon steel	grooved	TG96-42 ³	220.00
8"	unplated carbon steel	NPT	TM128-42 ⁴	258.50
8"	carbon steel	beveled	TP128-42 ⁴	258.50
8"	carbon steel	grooved	TG128-42 ⁴	258.50



^{1, 2, 3, 4} use with external swage ferrules on page C-23

Features:

- 150# ASA flange drilling available with carbon steel stem, flange and ferrule, or with 316 stainless steel stem and flange and carbon steel ferrule
- available in other sizes, consult Dixon® for pricing

External Swage Fixed Flange Assemblies

Hose ID	Hose OD		Carbon Steel		Stainless Steel	
	From	To	Part #	Price/E	Part #	Price/E
2"	2-28/64"	2-40/64"	32P1SO15	\$212.70	R32P1SOR15	\$442.00
	2-41/64"	2-48/64"	32P2SO15	212.70	R32P2SOR15	442.00
	2-49/64"	2-56/64"	32P3SO15	212.70	R32P3SOR15	442.00
3"	3-30/64"	3-40/64"	48P1SO15	271.00	R48P1SOR15	600.00
	3-41/64"	3-48/64"	48P2SO15	271.00	R48P2SOR15	600.00
	3-49/64"	3-56/64"	48P3SO15	271.00	R48P3SOR15	600.00
4"	4-40/64"	4-44/64"	64P1SO15	354.00	R64P1SOR15	875.00
	4-45/64"	4-52/64"	64P2SO15	354.00	R64P2SOR15	875.00
	4-53/64"	4-60/64"	64P3SO15	354.00	R64P3SOR15	875.00
6"	7"	7-4/64"	96P1SO15	675.00	R96P1SOR15	1542.00
	7-5/64"	7-12/64"	96P2SO15	675.00	R96P2SOR15	1542.00
	7-13/64"	7-20/64"	96P3SO15	675.00	R96P3SOR15	1542.00
8"	9-20/64"	9-24/64"	128P1SO15	1020.00	---	---
	9-25/64"	9-32/64"	128P2SO15	1020.00	---	---
	9-33/64"	9-40/64"	128P3SO15	1020.00	---	---



• For flange dimensions, diagrams and additional information please reference dixonvalve.com.

External Swage Floating Flange Assemblies

Hose ID	Hose OD		Carbon Steel		Stainless Steel	
	From	To	Part #	Price/E	Part #	Price/E
2"	2-28/64"	2-40/64"	32P1LJ15	\$260.00	R32P1LJR15	\$510.00
	2-41/64"	2-48/64"	32P2LJ15	260.00	R32P2LJR15	510.00
	2-49/64"	2-56/64"	32P3LJ15	260.00	R32P3LJR15	510.00
3"	3-30/64"	3-40/64"	48P1LJ15	288.40	R48P1LJR15	690.00
	3-41/64"	3-48/64"	48P2LJ15	288.40	R48P2LJR15	690.00
	3-49/64"	3-56/64"	48P3LJ15	288.40	R48P3LJR15	690.00
4"	4-40/64"	4-44/64"	64P1LJ15	450.00	R64P1LJR15	1197.00
	4-45/64"	4-52/64"	64P2LJ15	450.00	R64P2LJR15	1197.00
	4-53/64"	4-60/64"	64P3LJ15	450.00	R64P3LJR15	1197.00
6"	7"	7-4/64"	96P1LJ15	840.00	R96P1LJR15	1800.00
	7-5/64"	7-12/64"	96P2LJ15	840.00	R96P2LJR15	1800.00
	7-13/64"	7-20/64"	96P3LJ15	840.00	R96P3LJR15	1800.00
8"	9-20/64"	9-24/64"	128P1LJ15	1150.00	---	---
	9-25/64"	9-32/64"	128P2LJ15	1150.00	---	---
	9-33/64"	9-40/64"	128P3LJ15	1150.00	---	---



• For flange dimensions, diagrams and additional information please reference dixonvalve.com.



two piece design
1"



one piece design
1 1/4" - 2"

External Swage Stems - Female End

Size	Hose OD		Plated Carbon Steel	
	from	to	Part #	Price/E
1"	1-30/64"	1-34/64"	TF16WF1-80	\$46.70
	1-34/64"	1-38/64"	TF16WF2-80	47.60
	1-35/64"	1-42/64"	TF16WF3-80	46.70
1 1/4"	1-44/64"	1-48/64"	TF20WF1-80¹	149.00
	1-49/64"	1-56/64"	TF20WF2-80¹	149.00
	1-57/64"	2"	TF20WF3-80¹	149.00
2"	2-36/64"	2-40/64"	TF32WF1-80¹	162.75
	2-41/64"	2-48/64"	TF32WF2-80¹	162.75
	2-49/64"	2-56/64"	TF32WF3-80¹	162.75

¹ Special pusher required for 1 1/4" and 2" sizes: 1 1/4" **25PUSH125-MOD**, 2" **25PUSH200MOD**

External Swage Uni-Range Male Couplings

Applications:

- Recommended for use on most one or two wire braid reinforced hoses, fiber reinforced (braided or spiral) with or without helical wire such as chemical, high pressure air and water hoses, and LP gas hoses.

Features:

- designed for smaller hose systems, hose ID's of 1/4" - 1"
- shipped complete with factory assembled stem and ferrule combination
- can be swaged or crimped
- stainless steel stems are investment cast
- other hose OD's available, consult Dixon®



Hose ID	Hose ID		Plated Carbon Steel		Stainless/Carbon Steel		Stainless Steel	
	From	To	Part #	Price/E	Part #	Price/E	Part #	Price/E
1/4"	34/64"	38/64"	4P1	\$16.05	---	---	---	---
	38/64"	42/64"	4P2	16.05	---	---	---	---
	42/64"	46/64"	4P3	16.05	---	---	---	---
3/8"	46/64"	50/64"	6P1	23.50	---	---	---	---
	50/64"	54/64"	6P2	23.50	---	---	---	---
	54/64"	58/64"	6P3	23.50	---	---	---	---
1/2"	54/64"	58/64"	8P1	23.60	---	---	---	---
	58/64"	62/64"	8P2	23.60	---	---	R8P2SS	\$113.00
	62/64"	1-2/64"	8P3	23.60	---	---	---	---
3/4"	1-6/64"	1-12/64"	---	---	---	---	R12P1250	70.00
	1-10/64"	1-14/64"	12P1	23.80	R12P1	\$59.65	---	---
	1-13/64"	1-22/64"	---	---	---	---	R12P1370	70.00
	1-14/64"	1-18/64"	12P2	23.80	R12P2	59.65	---	---
	1-18/64"	1-22/64"	12P3	23.80	R12P3	59.65	---	---
1"	1-30/64"	1-34/64"	16P1	33.00	R16P1	105.00	---	---
	1-30/64"	1-38/64"	---	---	---	---	R16P1620	118.45
	1-34/64"	1-38/64"	16P2	33.00	R16P2	105.00	---	---
	1-38/64"	1-42/64"	16P3	33.00	R16P3	105.00	---	---
	1-38/64"	1-46/64"	---	---	---	---	R16P1770	119.60
	1-42/64"	1-46/64"	16P4	33.00	R16P4	105.00	---	---

External Swage Ferrules

The selection of ferrules is very important to achieve the proper coupling-to-hose assembly. For assistance in proper selection contact Dixon®.

Features:

- plated carbon steel
- style F ferrules are used with all standard length stems, page C-20
- style FL ferrules are extra long and are used with all long style stems, page C-20

Size	Hose OD		Plated Carbon Steel		Long Style Plated Carbon Steel	
	From	To	Part #	Price/E	Part #	Price/E
1"	1-44/64"	1-48/64"	F20-1	\$42.80	FL20-1	\$61.45
	1-49/64"	1-56/64"	F20-2	42.80	FL20-2	61.45
	1-57/64"	2"	F20-3	47.15	FL20-3	61.45
	2-1/64"	2-8/64"	F20-4	47.15	FL20-4	61.45
1½"	1-58/64"	2"	F24-1	37.35	FL24-1	56.85
	2-1/64"	2-8/64"	F24-2	38.10	FL24-2	56.85
	2-9/64"	2-16/64"	F24-3	40.40	FL24-3	56.85
	2-17/64"	2-24/64"	F24-4	43.00	FL24-4	56.85
	2-25/64"	2-32/64"	F24-5	43.00	FL24-5	56.85
2"	2-28/64"	2-40/64"	F32-1	38.50	FL32-1	57.00
	2-41/64"	2-48/64"	F32-2	38.00	FL32-2	57.00
	2-49/64"	2-56/64"	F32-3	49.00	FL32-3	57.00
	2-57/64"	3-2/64"	F32-4	45.80	FL32-4	57.00
2½"	2-62/64"	3-8/64"	F40-1	57.70	FL40-1	80.00
	3-9/64"	3-16/64"	F40-2	62.20	FL40-2	80.00
	3-17/64"	3-24/64"	F40-3	58.70	FL40-3	80.00
	3-25/64"	3-32/64"	F40-4	72.00	FL40-4	80.00
	3-33/64"	3-40/64"	F40-5	71.40	FL40-5	80.00
3"	3-30/64"	3-40/64"	F48-1	53.40	FL48-1	94.20
	3-41/64"	3-48/64"	F48-2	56.00	FL48-2	94.20
	3-49/64"	3-56/64"	F48-3	62.50	FL48-3	94.20
	3-57/64"	4"	F48-4	74.65	FL48-4	94.20
	4-1/64"	4-8/64"	F48-5	69.70	FL48-5	94.20
4"	4-30/64"	4-39/64"	F64-Z ¹	95.90	FL64-Z ²	120.00
	4-40/64"	4-44/64"	F64-1	95.80	FL64-1	120.00
	4-45/64"	4-52/64"	F64-2	94.00	FL64-2	120.00
	4-53/64"	4-60/64"	F64-3	95.80	FL64-3	120.00
	4-61/64"	5-4/64"	F64-4	95.80	FL64-4	120.00
	5-5/64"	5-12/64"	F64-5	108.00	FL64-5	120.00
	5-13/64"	5-20/64"	F64-6	108.00	FL64-6	120.00
	5-21/64"	5-28/64"	F64-7	108.00	FL64-7	120.00
5-29/64"	5-36/64"	F64-8	108.00	FL64-8	120.00	
5"	5-56/64"	5-60/64"	F80-1	240.00	FL80-1	POR
	5-61/64"	6-4/64"	F80-2	240.00	FL80-2	POR
	6-5/64"	6-12/64"	F80-3	250.00	FL80-3	POR
	6-13/64"	6-20/64"	F80-4	POR	FL80-4	POR
	6-21/64"	6-28/64"	F80-5	POR	FL80-5	POR
	6-29/64"	6-38/64"	F80-6	POR	FL80-6	POR
	6-37/64"	6-44/64"	F80-7	POR	FL80-7	POR
6"	6-44/64"	6-63/64"	F96-Z ³	227.70	FL96-Z ¹	304.75
	7"	7-4/64"	F96-1	235.00	FL96-1	304.75
	7-5/64"	7-12/64"	F96-2	235.00	FL96-2	304.75
	7-13/64"	7-20/64"	F96-3	235.00	FL96-3	304.75
	7-21/64"	7-28/64"	F96-4	245.00	FL96-4	304.75
	7-29/64"	7-36/64"	F96-5	245.00	FL96-5	304.75
	7-37/64"	7-44/64"	F96-6	255.30	FL96-6	304.75
	7-45/64"	7-52/64"	F96-7	255.30	FL96-7	304.75
	7-53/64"	7-60/64"	F96-8	255.30	FL96-8	304.75
7-61/64"	8"	F96-9	255.30	FL96-9	304.75	
8"	8-53/64"	8-56/64"	F128-X ⁴	398.00	---	---
	9"	9-9/64"	F128-Y	395.00	FL128-Y	POR
	9-20/64"	9-24/64"	F128-1	410.00	FL128-1	POR
	9-25/64"	9-32/64"	F128-2	418.00	FL128-2	POR
	9-33/64"	9-40/64"	F128-3	410.00	FL128-3	POR
	9-41/64"	9-48/64"	F128-4	463.50	FL128-4	POR
	9-49/64"	9-56/64"	F128-5	463.50	FL128-5	POR
9-57/64"	10"	F128-6	463.50	FL128-6	POR	
10"	10-1/64"	10-4/64"	F128-7	463.50	FL128-7	POR
	11-32/64"	11-44/64"	F160-1	750.00	FL160-1	POR
	11-45/64"	11-60/64"	F160-2	750.00	FL160-2	POR
	11-61/64"	12-12/64"	F160-3	POR	FL160-3	POR
	12-13/64"	12-28/64"	F160-4	POR	FL160-4	POR
	12-29/64"	12-44/64"	F160-5	POR	FL160-5	POR
	12-45/64"	12-60/64"	F160-6	POR	FL160-6	POR



long style

^{1,2,3,4} requires use with special stems on page C-21

• for applications with hose OD ranges not listed, contact Dixon™

External Swage Ferrules - Light Duty**Features:**

- for use with standard length stems styles TMR, TPR, and TGR series on page C-20
- consult Dixon® for die recommendations, go to dixonvalve.com for specific pressure recommendations



Hose ID	Hose OD		304 Stainless Steel	
	From	To	Part #	Price/E
1½"	1-60/64"	2-12/64"	GAS2334TO	\$42.40
	2-4/64"	2-22/64"	GAS2370TO	42.40
2"	2-30/64"	2-44/64"	GAS2709TO	34.40
	2-42/64"	2-54/64"	GAS2885TO	73.05
3"	3-30/64"	3-46/64"	GAS3760TO	53.30
	3-47/64"	3-54/64"	GAS3885TO	69.90
4"	4-40/64"	4-47/64"	GAS5010TO	275.00

Internal Expansion Coupling System

Applications:

- Essential in applications requiring maximum flow including: concrete pump hose, plaster and grout hose, oil suction and discharge hose, multi-purpose heavy duty air hose, jetting hose, barge loading hose and bottom loading hose.

Features:

- maximum flow of media
- reduction of turbulence through hose
- excellent sealing and retention characteristics
- outperforms band clamps
- easy and consistent installation
- only one expansion tool is needed for each hose ID
- available end configurations: male NPT, grooved, others available contact Dixon®

Holedall™ stems and ferrules are specifically designed to be used together as a coupling system.

Due to differences in dimensions and tolerances, for safety reasons, do not use other manufacturer's stems or ferrules with Holedall™ products.

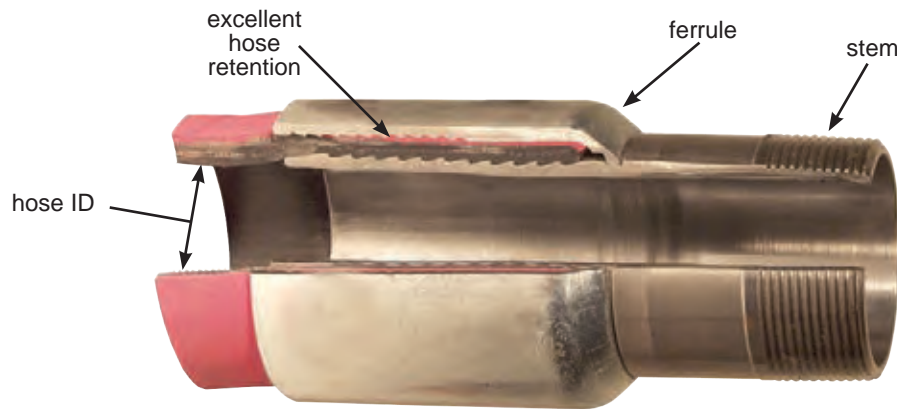

Cross-section of Holedall™ internally expanded assembly

Internal Expansion Male Pipe Threaded End Stems

Size	Working PSI ¹	Carbon Steel	
		Part #	Price/E
1"	---	IXM16	\$61.10
1¼"	800	IXM20	62.80
1½"	800	IXM24	58.00
2"	800	IXM32	57.25
2½"	600	IXM40	75.00
3"	600²	IXM48	96.30
4"	500²	IXM64	137.60
6"	400	IXM96	170.00



¹ maximum recommended working pressures at 70°F (21°C) ambient temperature

² For hoses which use IXF48-3 to IXF48-5 and IXF64-2 to IXF64-5, consult Dixon® for working pressures. See page C-18 for specific recommendations.

Internal Expansion Heavy Duty Raised End Stems

Size	Working PSI ¹	Carbon Steel	
		Part #	Price/E
1½"	800	IXH24	\$97.50
2"	800	IXH32	108.75
2½"	600	IXH40	130.20
3"	600²	IXH48	162.00
4"	500²	IXH64	216.00



¹ maximum recommended working pressures at 70°F (21°C) ambient temperature

² For hoses which use IXF48-3 to IXF48-5 and IXF64-2 to IXF64-5, consult Dixon® for working pressures. See page C-18 for specific recommendations.

Internal Expansion Grooved End Stems

Coupling Systems



Size	Working PSI ¹	Carbon Steel	
		Part #	Price/E
1¼"	800	<i>IXV20</i>	\$55.90
1½"	800	<i>IXV24</i>	56.50
2"	800	<i>IXV32</i>	59.90
2½"	600	<i>IXV40</i>	74.50
3"	600 ²	<i>IXV48</i>	106.10
4"	500 ²	<i>IXV64</i>	150.00

¹ maximum recommended working pressures at 70°F (21°C) ambient temperature

² For hoses which use IXF48-3 to IXF48-5 and IXF64-2 to IXF64-5, consult Dixon® for working pressures. See page C-18 for specific recommendations.

Internal Expansion Ferrules



Hose ID	Hose OD		Ferrule ID	Plated Carbon Steel		Hose ID	Hose OD		Ferrule ID	Plated Carbon Steel	
	From	To		Part #	Price/E		From	To		Part #	Price/E
1"	1-24/64"	1-28/64"	1-7/16"	<i>IXF16-1</i>	\$40.50	3"	3-32/64"	3-36/64"	3-9/16"	<i>IXF48-T</i>	\$75.30
	1-28/64"	1-32/64"	1-1/2"	<i>IXF16-2</i>	40.50		3-36/64"	3-40/64"	3-5/8"	<i>IXF48-U</i>	75.30
	1-32/64"	1-36/64"	1-9/16"	<i>IXF16-3</i>	40.50		3-40/64"	3-44/64"	3-11/16"	<i>IXF48-V</i>	75.30
1¼"	1-40/64"	1-44/64"	1-11/16"	<i>IXF20-Z</i>	38.00		3-44/64"	3-48/64"	3-3/4"	<i>IXF48-W</i>	75.30
	1-44/64"	1-48/64"	1-3/4"	<i>IXF20-1</i>	38.00		3-48/64"	3-52/64"	3-13/16"	<i>IXF48-X</i>	76.40
	1-48/64"	1-52/64"	1-13/16"	<i>IXF20-2</i>	38.00		3-52/64"	3-56/64"	3-7/8"	<i>IXF48-Y</i>	75.30
	1-52/64"	1-56/64"	1-7/8"	<i>IXF20-3</i>	38.00		3-56/64"	3-60/64"	3-15/16"	<i>IXF48-Z</i>	75.30
	1-56/64"	1-60/64"	1-15/16"	<i>IXF20-4</i>	38.00		3-60/64"	4"	4"	<i>IXF48-1</i>	81.25
	1-60/64"	2"	2"	<i>IXF20-5</i>	38.00		4"	4-4/64"	4-1/16"	<i>IXF48-2</i>	81.25
1½"	2"	2-4/64"	2-1/16"	<i>IXF20-6</i>	38.00		4-4/64"	4-8/64"	4-1/8"	<i>IXF48-3</i> ¹	81.25
	1-56/64"	1-60/64"	1-15/16"	<i>IXF24-Z</i>	37.65		4-8/64"	4-12/64"	4-3/16"	<i>IXF48-4</i> ¹	82.00
	1-60/64"	2"	2"	<i>IXF24-1</i>	37.65		4-12/64"	4-16/64"	4-1/4"	<i>IXF48-5</i> ¹	81.25
	2"	2-4/64"	2-1/16"	<i>IXF24-2</i>	37.65	4"	4-36/64"	4-40/64"	4-5/8"	<i>IXF64-T</i>	108.00
	2-4/64"	2-8/64"	2-1/8"	<i>IXF24-3</i>	37.65		4-40/64"	4-44/64"	4-11/16"	<i>IXF64-U</i>	108.00
	2-8/64"	2-12/64"	2-3/16"	<i>IXF24-4</i>	37.65		4-44/64"	4-48/64"	4-3/4"	<i>IXF64-V</i>	108.00
	2-12/64"	2-16/64"	2-1/4"	<i>IXF24-5</i>	37.65		4-48/64"	4-52/64"	4-13/16"	<i>IXF64-W</i>	108.00
	2-16/64"	2-20/64"	2-5/16"	<i>IXF24-6</i>	37.65		4-52/64"	4-56/64"	4-7/8"	<i>IXF64-X</i>	108.00
2-20/64"	2-24/64"	2-3/8"	<i>IXF24-7</i>	37.65	4-56/64"		4-60/64"	4-15/16"	<i>IXF64-Y</i>	108.00	
2"	2-32/64"	2-36/64"	2-9/16"	<i>IXF32-Y</i>	41.00		4-60/64"	5"	5"	<i>IXF64-Z</i>	108.00
	2-36/64"	2-40/64"	2-5/8"	<i>IXF32-Z</i>	41.00		5"	5-4/64"	5-1/16"	<i>IXF64-1</i>	108.00
	2-40/64"	2-44/64"	2-11/16"	<i>IXF32-1</i>	40.15	5-4/64"	5-8/64"	5-1/8"	<i>IXF64-2</i> ¹	108.00	
	2-44/64"	2-48/64"	2-3/4"	<i>IXF32-2</i>	40.15	5-8/64"	5-12/64"	5-3/16"	<i>IXF64-3</i> ¹	108.00	
	2-48/64"	2-52/64"	2-13/16"	<i>IXF32-3</i>	40.15	5-12/64"	5-16/64"	5-1/4"	<i>IXF64-4</i> ¹	108.00	
	2-52/64"	2-56/64"	2-7/8"	<i>IXF32-4</i>	40.15	5-16/64"	5-20/64"	5-5/16"	<i>IXF64-5</i> ¹	108.00	
	2-56/64"	2-60/64"	2-15/16"	<i>IXF32-5</i>	40.15	6"	6-40/64"	6-44/64"	6-11/16"	<i>IXF96-1</i>	POR
	2-60/64"	3"	3"	<i>IXF32-6</i>	40.15		6-44/64"	6-48/64"	6-3/4"	<i>IXF96-2</i>	POR
	3"	3-4/64"	3-1/16"	<i>IXF32-7</i>	40.15		6-46/64"	6-50/64"	6-25/32"	<i>IXF96-3</i>	POR
	2½"	3"	3-4/64"	3-1/16"	<i>IXF40-1</i>		59.50	6-48/64"	6-52/64"	6-13/16"	<i>IXF96-4</i>
3-4/64"		3-8/64"	3-1/8"	<i>IXF40-2</i>	59.50		6-52/64"	6-56/64"	6-7/8"	<i>IXF96-5</i>	POR
3-8/64"		3-12/64"	3-3/16"	<i>IXF40-3</i>	59.50		6-56/64"	6-60/64"	6-15/16"	<i>IXF96-6</i>	POR
3-12/64"		3-16/64"	3-1/4"	<i>IXF40-4</i>	59.50		6-60/64"	7"	7"	<i>IXF96-7</i>	POR
3-16/64"		3-20/64"	3-5/16"	<i>IXF40-5</i>	59.50		7"	7-4/64"	7-1/16"	<i>IXF96-8</i>	POR
3-20/64"		3-24/64"	3-3/8"	<i>IXF40-6</i>	59.50		7-4/64"	7-8/64"	7-1/8"	<i>IXF96-9</i>	POR
3-24/64"		3-28/64"	3-7/16"	<i>IXF40-7</i>	59.50		7-8/64"	7-12/64"	7-3/16"	<i>IXF96-10</i>	POR
3-28/64"		3-32/64"	3-1/2"	<i>IXF40-8</i>	59.50	7-12/64"	7-16/64"	7-1/4"	<i>IXF96-11</i>	POR	
					7-16/64"	7-20/64"	7-5/16"	<i>IXF96-12</i>	POR		
					7-18/64"	7-22/64"	7-11/32"	<i>IXF96-13</i>	POR		
					7-20/64"	7-24/64"	7-3/8"	<i>IXF96-14</i>	POR		

¹ for hoses using ferrule sizes IXF48-3 thru IXF48-5 and IXF64-2 thru IXF64-5, consult Dixon® for working pressures

• for use with IX stems on pages C-25

Scovill Style Couplings

Applications:

- recommended for discharge and suction service; commonly used in the transfer of fuel to homes, airplanes, ships, etc.
- intended for fuel delivery service, see page C-29 for information on API 1529 certification

Features:

- male and female stems are machined from bar stock or solid brass forgings; ferrules are available in brass and stainless steel
- compact, lightweight and streamlined to eliminate catching on curbs and shrubs
- stems and ferrules are designed to be used together as a coupling system
- stem is expanded to nominal ID of hose for a rigid, uniform, full-flow area
- all fittings have octagonal facets for tightening with a wrench; females in 1½" and larger sizes have lugs for tightening
- pre-lubricated for assembly
- designed for internal expansion only
- hand and electrically operated installation equipment is available, consult Dixon® for pricing and availability
- working pressure varies with the size of the fitting, the size and construction of the hose and the media being conveyed, consult Dixon® for recommendations
- do not interchange with other manufacturers



Scovill Style Permanent Male Couplings

Size	Thread	Brass	
		Part #	Price/E
¾"	NPT	H5192	\$23.85
1"	NST	H5212NST	26.50
1¼"	NPT	H5222-A	35.50
1⅜"	NPT	H5272¹	41.85
1½"	NST	H5232NST	42.05
2"	NPT	H5242	81.70
2½"	NPT	H5252	138.00
3"	NPT	H5262	185.00

¹ 1⅜" stem has 1½" thread



Scovill Style Permanent Female Couplings

Size	Thread	Brass	
		Part #	Price/E
¾"	NPSH	H5191-BU	\$41.00
1"	NST	H5211NST	51.75
1¼"	NPT	H5221-A-BU	52.10
1⅜"	NPSH	H5271-BU¹	79.20
1½"	NST	H5231NST²	83.60
2"	NPSH	H5241-BU	137.90
2½"	NPSH	H5251³	215.00
3"	NPSH	H5261³	282.00

¹ 1⅜" stem has 1½" thread

² 1½" NST requires special adapter, part # H5231NSTADT

³ 2½" and 3" parts have female NPSM thread



Scovill Style Permanent Grooved Couplings

Size	Brass	
	Part #	Price/E
¾"	---	---
1"	G5212	\$32.55
1¼"	---	---
1⅜"	---	---
1½"	G5232	59.20
2"	G5242	80.50
2½"	G5252	138.00
3"	---	---



Scovill Style Series Ferrules

Feature:

- Eliminates the need for a large stock of coupling bodies. With a wide range of sizes available, you can build the perfect assembly of a coupling to a corresponding hose size with commercial tolerances, regardless of wall thickness
- for use with scovill style couplings on pages C-27
- sizes 1", 1¼" and 1½" can be found on page C-30

Hose ID	Hose OD		Brass	
	From	To	Part #	Price/E
¾"	1-4/64"	1-7/64"	R75AAAS	\$8.55
	1-8/64"	1-11/64"	R75AAS	8.55
	1-12/64"	1-14/64"	R75AS	8.55
	1-15/64"	1-17/64"	R75BS	8.55
	1-18/64"	1-20/64"	R75CS	8.55
1⅜"	1-47/64"	1-50/64"	R1375BS	17.60
	1-51/64"	1-54/64"	R1375CS	17.60
	1-55/64"	1-58/64"	R1375DS	17.60
	1-59/64"	1-62/64"	R1375ES	17.60
1½"	2-25/64"	2-28/64"	R15GS¹	17.55
2"	2-27/64"	2-30/64"	R2AAS	32.80
	2-31/64"	2-34/64"	R2AS	32.80
	2-35/64"	2-38/64"	R2BS	32.80
	2-39/64"	2-42/64"	R2CS	32.80
	2-43/64"	2-46/64"	R2DS	32.80
	2-47/64"	2-50/64"	R2ES	32.80
	2-51/64"	2-54/64"	R2FS	32.80
2½"	2-62/64"	3-1/64"	R25AS	46.10
	3-2/64"	3-6/64"	R25BS	46.10
	3-7/64"	3-11/64"	R25CS	46.10
	3-12/64"	3-16/64"	R25DS	46.10
	3-17/64"	3-21/64"	R25ES	46.10
3"	3-22/64"	3-26/64"	R25FS	46.10
	3-30/64"	3-34/64"	R3AAAS	62.90
	3-35/64"	3-39/64"	R3AAS	62.90
	3-40/64"	3-45/64"	R3AS	62.90
	3-46/64"	3-50/64"	R3BS	62.90
	3-51/64"	3-54/64"	R3CS	62.90

¹ will be replaced by API ferrules



API Certified Permanently Attached Petroleum Male Couplings

Feature:

- Tested and compliant with API 1529 6th edition. Coupling procedures, ferrule recommendations and API test data are available upon request, please contact Dixon® at engineering@dixonvalve.com.

Size	Thread Type	Brass	
		Part #	Price/E
1"	NPT	H5212-A	\$26.35
1¼"	NPT	H5222-A	35.50
1½"	NPT	H5232-A	43.35
2"	NPT	H5242L-A	81.70
2½"	NPT	H5252L-A	138.00
3"	NPT	H5262L-A	185.00
4"	NPT	H5282L-A	340.00



API Certified Permanently Attached Petroleum Female Couplings

Size	Thread Type	Brass	
		Part #	Price/E
1"	NPSH	H5211-A-BU	\$43.75
1¼"	NPSH	H5221-A-BU	52.10
1½"	NPSH	H5231-A-BU	78.60
2"	NPSH	H5241L-A-BU	137.90
2½"	NPSM	H5251L-A-BU	215.00
3"	NPSM	H5261L-A-BU	282.00
4"	NPSM	H5281L-A-BU	415.00



API Certified Series Ferrules

Coupling Systems



brass



304 stainless steel



aluminum

Hose ID	Hose OD		Brass		304 Stainless Steel		Aluminum	
	From	To	Part #	Price/E	Part #	Price/E	Part #	Price/E
1"	1-24/64"	1-26/64"	R1AAAS-A	\$9.95	---	---	---	---
	1-27/64"	1-29/64"	R1AAS-A	9.95	---	---	---	---
	1-30/64"	1-32/64"	R1AS-A	9.95	---	---	---	---
	1-33/64"	1-35/64"	R1BS-A	9.95	---	---	---	---
	1-36/64"	1-38/64"	R1CS-A	9.95	---	---	---	---
	1-39/64"	1-41/64"	R1DS-A	9.95	---	---	---	---
	1-42/64"	1-44/64"	R1ES-A	9.95	---	---	---	---
1¼"	1-39/64"	1-42/64"	R125AAS-A	14.70	---	---	---	---
	1-43/64"	1-46/64"	R125AS-A	14.70	---	---	---	---
	1-47/64"	1-50/64"	R125BS-A	14.70	---	---	---	---
	1-51/64"	1-54/64"	R125CS-A	14.70	---	---	---	---
	1-55/64"	1-58/64"	R125DS-A	14.70	---	---	---	---
	1-59/64"	1-62/64"	R125ES-A	14.70	---	---	---	---
1½"	1-54/64"	1-57/64"	R15AAAS-A	18.55	---	---	---	---
	1-58/64"	1-62/64"	R15AAS-A	18.55	---	---	---	---
	1-63/64"	2-2/64"	R15AS-A	18.55	---	---	---	---
	2-3/64"	2-6/64"	R15BS-A	18.55	---	---	---	---
	2-7/64"	2-11/64"	R15CS-A	18.55	---	---	---	---
	2-12/64"	2-14/64"	R15DS-A	18.55	---	---	---	---
	2-15/64"	2-19/64"	R15ES-A	18.55	---	---	---	---
	2-20/64"	2-24/64"	R15FS-A	17.55	---	---	---	---
2"	2-31/64"	2-34/64"	---	---	R2ASS-A	\$28.35	R2AAL-A	\$20.00
	2-35/64"	2-38/64"	---	---	R2BSS-A	28.35	R2BAL-A	20.00
	2-39/64"	2-42/64"	---	---	R2CSS-A	28.35	R2CAL-A	20.00
	2-43/64"	2-46/64"	---	---	R2DSS-A	28.35	R2DAL-A	20.00
	2-47/64"	2-50/64"	---	---	R2ESS-A	28.35	R2EAL-A	20.00
2½"	2-62/64"	3-1/64"	---	---	R25ASS-A	42.25	R25AAL-A	30.00
	3-2/64"	3-6/64"	---	---	R25BSS-A	42.25	R25BAL-A	30.00
	3-7/64"	3-11/64"	---	---	R25CSS-A	42.25	R25CAL-A	30.00
	3-12/64"	3-16/64"	---	---	R25DSS-A	42.25	R25DAL-A	30.00
3"	3-17/64"	3-21/64"	---	---	R25ESS-A	42.25	R25EAL-A	30.00
	3-35/64"	3-39/64"	---	---	R3AASS-A	49.25	R3AAAL-A	35.00
	3-40/64"	3-45/64"	---	---	R3ASS-A	49.25	R3AAL-A	35.00
	3-46/64"	3-50/64"	---	---	R3BSS-A	49.25	R3BAL-A	35.00
	3-51/64"	3-54/64"	---	---	R3CSS-A	49.25	R3CAL-A	35.00
4"	3-55/64"	3-59/64"	---	---	R3DSS-A	49.25	R3DAL-A	35.00
	4-46/64"	4-48/64"	---	---	R4ESS-A	164.00	---	---
	4-49/64"	4-51/64"	---	---	R4FSS-A	164.00	---	---
	4-52/64"	4-54/64"	---	---	R4GSS-A	164.00	---	---
	4-55/64"	4-57/64"	---	---	R4HSS-A	164.00	---	---
	4-58/64"	4-59/64"	---	---	R4KSS-A	164.00	---	---
	4-60/64"	4-62/64"	---	---	R4LSS-A	164.00	---	---
4-63/64"	5"	---	---	R4MSS-A	164.00	---	---	

• for use with API couplings on pages C-29

Female Replacement Washers

Feature:

- for use with female internally expanded permanent couplings on pages C-27 and C-29

Size	Part #	Price/E
	<i>Buna</i>	
3/4"	H5071-BU	\$1.20
1"	H5072-BU	1.20
1 1/4"	H5073-BU	1.20
1 1/2"	H5074-BU	1.20
2"	H5075-BU	1.30
2 1/2"	H5076-BU	1.30
3"	H5077-BU	1.35
4"	H5078-BU	1.80



HB Coupling Expander Machine

Features:

- hand operated, pull-through type expander
- for use in a fixed location for small production runs or as a portable repair type expander
- attaches sizes 3/4" through 2" of the Scovil style and all sizes of the curb pump fittings
- expander tooling sold separately

Part #	Price/E
2500HB0000	\$3180.00



Permanent Pump Hose Couplings



Application:

- economical and trouble-free couplings for gas pump hose

Features:

- serrations on the stem embed in the hose eliminating wicking and leakage
- shell extends beyond the stem preventing cutting of interior walls; tapered ends of stem and shell protect hose when flexed
- provide tamper-proof static connection which cannot be broken without completely damaging coupling and hose
- internal expansion of stem to nominal ID of hose provides full flow
- broad, firm grip of coupling extends hose life by making it possible for hose to withstand more flexings
- Hand and electrically operated installation equipment is available; consult Dixon® for pricing and availability.
- UL listed
- *Reattach static wire if required.*



Size	Male NPT	Hose OD	Part #	Price/E
			<i>Chrome Plated Brass</i>	
5/8"	3/4"	1"	H5741	\$15.15
5/8"	3/4"	1-1/32"	H5742	15.15
3/4"	3/4"	1-9/64"	H5751	17.60
3/4"	3/4"	1-11/64"	H5752	17.60
3/4"	3/4"	1-13/64"	H5753	27.10
3/4"	3/4"	1-7/32"	H5754	27.10
3/4"	3/4"	1-17/64"	H5755¹	27.10
1"	1"	1-25/64"	H5771	32.00
1"	1"	1-29/64"	H5772	32.00
1"	1"	1-1/2"	H5773	32.00
1"	1"	1-9/16"	H5774	32.00

¹ thrust plate required **2500HTL15**



Dubl-Grip® Re-attachable Couplings for Curb Pump Hose

Features:

- two-piece construction
- streamlined design prevents damage to hose and fits well on new pump equipment
- wide, flat surfaces of body threads protect inside of hose from breaking
- tapered surface of sleeve and body cradle hose preventing one-point strain from flexing
- Hose is gripped on its full circumference in two places, ensuring a rigid leakproof connection.
- re-attachable: worn portion of hose can be removed and Dubl-Grip® can be reapplied
- easy assembly:
 - Hose is held in position by sleeve as body is threaded home.
 - Only a wrench is required to assemble the Dubl-Grip®.
- Underwriters Listed approved
- *Reattach static wire if required.*



Swivel

Hose ID	Male NPT	Hose OD	Chrome Plated Brass	
			Part #	Price/E
3/4"	3/4"	1 1/8"	H603	\$37.50
3/4"	3/4"	1-13/64"	H604	37.50
3/4"	3/4"	1 1/4"	H605	37.50
1"	1"	1 3/8"	H609 ¹	58.00
1"	1"	1-7/16"	H610 ¹	58.00
1"	1"	1-1/2"	H611 ¹	58.00

¹ octagonal shape

Non-Swivel

Hose ID	Male NPT	Hose OD	Chrome Plated Brass	
			Part #	Price/E
5/8"	3/4"	1"	850212	\$20.50
5/8"	3/4"	1-1/32"	850213	20.50
3/4"	3/4"	1 1/8"	850451	27.90
3/4"	3/4"	1-13/64"	850455	27.90
3/4"	3/4"	1 1/4"	850453	27.90
1"	1"	1 3/8"	850841 ¹	43.20
1"	1"	1-7/16"	850801 ¹	43.20
1"	1"	1 1/2"	850811 ¹	44.00



CIP Internal Expansion (IX) Sanitary Style Hose Couplings

Application:

- used in the food, dairy and beverage industries

Features:

- Clean-In-Place (CIP) compliant
- Flow Chief internal expansion (IX) fittings are only to be used with Flow Chief stainless steel ferrules.

Sanitary Style Clamp End Stems

Features:

- 3A compliant when assembled by 3A authorized hose shop
- special plug is required to expand CIP compliant fittings
- special adapter plate is required to expand 1½" CIP compliant fittings
- see pages J-146 to J-149 for sanitary style gaskets
- see pages J-130 to J-132 for sanitary style clamps

Size	304 Stainless Steel	
	Part #	Price/E
1½"	IXSE24-3A	\$173.50
2"	IXSE32-3A	195.00
3"	IXSE48-3A	350.00



Special Expansion Plugs for CIP Compliant IX Fitting

Hose Size	304 Stainless Steel	
	Part #	
1½"	IXFDPLG137	
2"	IXFDPLG187	
3"	IXFDPLG287	



CIP Internal Expansion (IX) Sanitary Style Tube Weld End Stem

Feature:

- special plug is required to expand CIP compliant fittings

Size	304 Stainless Steel	
	Part #	Price/E
2"	IXPE32-3A	\$175.00



Internal Expansion (IX) Sanitary Style Clamp End Stems

Features:

- clamp end x hose shank
- Flow Chief internal expansion (IX) fittings are only to be used with Flow Chief stainless steel ferrules.
- see pages J-146 to J-149 for sanitary style gaskets
- see pages J-130 to J-132 for sanitary style clamps

Size	304 Stainless Steel	
	Part #	Price/E
1½"	IXSE24	\$138.40
2"	IXSE32	169.00
2½"	IXSE40	270.00
3"	IXSE48	350.50
4"	IXSE64	470.00



Internal Expansion (IX) Sanitary Style Male NPT Stems

Feature:

- Flow Chief internal expansion (IX) fittings are only to be used with Flow Chief stainless steel ferrules.



Size	304 Stainless Steel	
	Part #	Price/E
1½"	IXMS24	\$186.35
2"	IXMS32	180.00
2½"	IXMS40	230.00
3"	IXMS48	351.00
4"	IXMS64	500.00

Internal Expansion (IX) Sanitary Style Bevel Seat Hose Couplings

Features:

- Flow Chief internal expansion (IX) fittings are only to be used with Flow Chief stainless steel ferrules.
- see page J-159 for bevel seat gaskets

Internal Expansion (IX) Sanitary Style Bevel Seat Stems

Feature:

- only use with the IXAN nuts shown below



Size	304 Stainless Steel	
	Part #	Price/E
1½"	IXFS24	\$154.35
2"	IXFS32	210.10
2"	IXFS32-3A ¹	215.00
2½"	IXFS40	236.90
3"	IXFS48	375.00
4"	IXFS64	395.00

¹ must use plug part # IXFDPLG187

Internal Expansion (IX) Sanitary Style Bevel Seat Threaded Hex Nuts

series 13H (modified)



Size	304 Stainless Steel	
	Part #	Price/E
1½"	IXAN24	\$37.10
2"	IXAN32	49.10
2½"	IXAN40	73.00
3"	IXAN48	92.25
4"	IXAN64	155.00

Internal Expansion Sanitary Style Flow Chief Ferrules

Feature:

- ferrule ID's are designed in increments of 1/16"

Hose ID	Hose OD		304 Stainless Steel	
	From	To	Part #	Price/E
1½" ¹	1-56/64"	1-59/64"	24PFX1.937	\$105.50
	1-60/64"	1-63/64"	24PFX2.000	105.50
	2"	2-3/64"	24PFX2.062	105.50
	2-4/64"	2-7/64"	24PFX2.125	105.50
	2-8/64"	2-11/64"	24PFX2.187	105.50
	2-12/64"	2-15/64"	24PFX2.250	105.50
	2-16/64"	2-19/64"	24PFX2.312 ²	105.50
2" ¹	2-28/64"	2-31/64"	32PFX2.500	108.00
	2-32/64"	2-35/64"	32PFX2.562	108.00
	2-36/64"	2-39/64"	32PFX2.625	108.00
	2-40/64"	2-43/64"	32PFX2.687	108.00
	2-44/64"	2-47/64"	32PFX2.750	108.00
	2-48/64"	2-51/64"	32PFX2.812	108.00
	2-52/64"	2-55/64"	32PFX2.875	108.00
	2-56/64"	2-59/64"	32PFX2.937	108.00
2½"	3"	3-3/64"	40PFX3.062	151.00
	3-4/64"	3-7/64"	40PFX3.125	151.00
	3-8/64"	3-11/64"	40PFX3.187	151.00
	3-12/64"	3-15/64"	40PFX3.250	151.00
	3-16/64"	3-19/64"	40PFX3.312	151.00
	3-20/64"	3-23/64"	40PFX3.375	151.00
	3-28/64"	3-31/64"	40PFX3.500	151.00
3"	3-32/64"	3-35/64"	48PFX3.562	172.50
	3-36/64"	3-39/64"	48PFX3.625	172.50
	3-40/64"	3-43/64"	48PFX3.687	172.50
	3-44/64"	3-47/64"	48PFX3.750	172.50
	3-48/64"	3-51/64"	48PFX3.812	172.50
	3-52/64"	3-55/64"	48PFX3.875	172.50
	3-56/64"	3-59/64"	48PFX3.937	172.50
	3-60/64"	3-63/64"	48PFX4.000	172.50
	4"	4-3/64"	48PFX4.062	172.50
	4-4/64"	4-7/64"	48PFX4.125	172.50
4"	4-36/64"	4-39/64"	64PFX4.625	235.00
	4-40/64"	4-43/64"	64PFX4.687	235.00
	4-44/64"	4-47/64"	64PFX4.750	235.00
	4-48/64"	4-51/64"	64PFX4.812	235.00
	4-52/64"	4-55/64"	64PFX4.875	235.00
	4-56/64"	4-59/64"	64PFX4.937	235.00



¹ 1½" and 2" ferrules do not have serrations on the ID

² consult Dixon® at engineering@dixonvalve.com for working pressure

- for use with IX stems on pages C-33 and C-34

Dixon Sanitary King Crimp™ Tri-Clover Stems

Features:

- to be used with King Crimp™ sleeves and/or ferrules see pages C-42 to C-45
- wetted surfaces meet governmental and independent regulatory standards only



Size	316 Stainless Steel	
	Part #	Price/E
1"	CSSR100CS	\$75.60
1½"	CSSR150CS	77.85
2"	CSSR200CS	135.50
3"	CSSR300CS	302.60
4"	CSSR400CS	400.00

Dixon Sanitary Style Crimp Stem Female Bevel Seat End x Hose Shank

Features:

- to be used with Sanitary ferrules on page C-37



Size	Nut Used	316 Stainless Steel	
		Part #	Price/E
1"	13H-G100	CBSR100	\$75.60
1½"	IXAN24	CBSR150	77.85
2"	IXAN32	CBSR200	135.50
3"	IXAN300	CBSR300	302.10
4"	IXAN64	CBSR400	562.85

Dixon Sanitary Style Crimp Stem Female I-Line End x Hose Shank

Features:

- to be used with Sanitary ferrules on page C-37



Size	316 Stainless Steel	
	Part #	Price/E
1½"	CILR150	\$77.85
2"	CILR200	135.50
3"	CILR300	302.10
4"	CILR400	562.85

Dixon Sanitary Style Crimp Stem Tube Weld End x Hose Shank

Features:

- to be used with Sanitary ferrules on page C-37



Size	316 Stainless Steel	
	Part #	Price/E
1½"	CTER150	\$77.85
2"	CTER200	135.50
3"	CTER300	302.10
4"	CTER400	562.85

Dixon Sanitary Style Crimp Stem Clamp End x Hose Shank

Features:

- sanitary style end
- Dixon® sanitary crimp stems are only to be used with Dixon® sanitary stainless steel crimp ferrules on page C-37
- reference dixonvalve.com for crimp recommendations



Size	316 Stainless Steel	
	Part #	Price/E
1"	CSSR100	\$75.60
1½"	CSSR150	77.85
2"	CSSR200	135.50
2½"	CSSR250	275.00
3"	CSSR300	302.60
4"	CSSR400	400.00

Holedall™ **DIN External Crimp Female Stems**

Size	316 Stainless Steel		
	DIN	Part #	Price/E
1½"	40	HA0240	\$88.30
2"	50	HA0241	127.80
2½"	65	HA0242	170.00
3"	80	HA0243	239.75



Holedall™ **DIN External Crimp Male Stems**

Size	316 Stainless Steel		
	DIN	Part #	Price/E
1½"	40	HA0235	\$98.95
2"	50	HA0236	138.50
2½"	65	HA0237	170.00
3"	80	HA0238	250.10



• please visit dixonvalve.com for crimp recommendations

Dixon® Sanitary Style Crimp Ferrules

Features:

- AISI 304 stainless steel
- ferrules have a surface finish of 63 or better

Size	Hose OD		304 Stainless Steel	
	From	To	Part #	Price/E
1"	1-26/64"	1-28/64"	F16G-1453	\$51.50
	1-29/64"	1-31/64"	F16G-1500	51.50
	1-32/64"	1-34/64"	F16G-1547	51.50
	1-35/64"	1-37/64"	F16G-1594	51.50
	1-38/64"	1-40/64"	F16G-1641	51.50
1½"	1-58/64"	1-61/64"	F24G-1969	59.45
	1-62/64"	2-1/64"	F24G-2031	59.45
	2-2/64"	2-5/64"	F24G-2094	59.45
	2-6/64"	2-9/64"	F24G-2156	59.45
	2-10/64"	2-13/64"	F24G-2219	59.45
	2-14/64"	2-17/64"	F24G-2281	59.45
	2-18/64"	2-21/64"	F24G-2344	59.45
2"	2-30/64"	2-33/64"	F32G-2531	77.80
	2-34/64"	2-37/64"	F32G-2594	77.80
	2-38/64"	2-41/64"	F32G-2656	77.80
	2-42/64"	2-45/64"	F32G-2719	77.80
	2-52/64"	2-55/64"	F32G-2875	77.80
	2-56/64"	2-59/64"	F32G-2938	77.80
2½"	3"	3-3/64"	F40G-3063	198.00
	3-4/64"	3-7/64"	F40G-3125	198.00
	3-8/64"	3-11/64"	F40G-3188	198.00
	3-12/64"	3-15/64"	F40G-3250	198.00
	3-16/64"	3-19/64"	F40G-3313	198.00
	3-20/64"	3-23/64"	F40G-3375	198.00
3"	3-36/64"	3-39/64"	F48G-3625	208.00
	3-40/64"	3-43/64"	F48G-3688	208.00
	3-44/64"	3-47/64"	F48G-3750	208.00
	3-48/64"	3-51/64"	F48G-3813	208.00
	3-52/64"	3-55/64"	F48G-3875	208.00
	3-56/64"	3-59/64"	F48G-3938	208.00
	3-61/64"	4"	F48G-4016	208.00
4"	4-40/64"	4-43/64"	F64G-4688	315.00
	4-44/64"	4-47/64"	F64G-4750	315.00
	4-48/64"	4-51/64"	F64G-4813	315.00
	4-52/64"	4-55/64"	F64G-4875	315.00
	4-56/64"	4-59/64"	F64G-4938	315.00
	5-5/64"	5-8/64"	F64G-5141	315.00



Crimp Working Pressure Chart

Coupling Systems

Size	Temperature	Fitting	Clamp	Working Pressure PSIG	Size	Temperature	Fitting	Clamp	Working Pressure PSIG
1"	Ambient	STC10CS	sleeve	400	3"	Ambient	STC35CS	sleeve	200
	160°F (71°C)	STC10CS	sleeve	270		160°F (71°C)	STC35CS	sleeve	140
	180°F (82°C)	STC10CS	sleeve	250		180°F (82°C)	STC35CS	sleeve	100
	250°F (121°C)	STC10CS	sleeve	200		250°F (121°C)	STC35CS	sleeve	75
	Ambient	STC10CS	ferrule	400		Ambient	STC35CS	ferrule	300
	160°F (71°C)	STC10CS	ferrule	270		160°F (71°C)	STC35CS	ferrule	218
	180°F (82°C)	STC10CS	ferrule	250		180°F (82°C)	STC35CS	ferrule	200
	250°F (121°C)	STC10CS	ferrule	200		250°F (121°C)	STC35CS	ferrule	100
	Ambient	100-C/E	sleeve	250		Ambient	300-C/E	sleeve	125
	160°F (71°C)	100-C/E	sleeve	242		160°F (71°C)	300-C/E	sleeve	100
	180°F (82°C)	100-C/E	sleeve	240		180°F (82°C)	300-C/E	sleeve	60
	250°F (121°C)	100-C/E	sleeve	200		250°F (121°C)	300-C/E	sleeve	55
	Ambient	100-C/E	ferrule	250		Ambient	300-C/E	ferrule	150
	160°F (71°C)	100-C/E	ferrule	242		160°F (71°C)	300-C/E	ferrule	125
	180°F (82°C)	100-C/E	ferrule	240		180°F (82°C)	300-C/E	ferrule	100
250°F (121°C)	100-C/E	ferrule	200	250°F (121°C)	300-C/E	ferrule	75		
1 1/2"	Ambient	STC20CS	sleeve	300	4"	Ambient	STC40CS	sleeve	175
	160°F (71°C)	STC20CS	sleeve	225		160°F (71°C)	STC40CS	sleeve	100
	180°F (82°C)	STC20CS	sleeve	200		180°F (82°C)	STC40CS	sleeve	100
	250°F (121°C)	STC20CS	sleeve	100		250°F (121°C)	STC40CS	sleeve	50
	Ambient	STC20CS	ferrule	350		Ambient	STC40CS	ferrule	300
	160°F (71°C)	STC20CS	ferrule	225		160°F (71°C)	STC40CS	ferrule	218
	180°F (82°C)	STC20CS	ferrule	200		180°F (82°C)	STC40CS	ferrule	200
	250°F (121°C)	STC20CS	ferrule	150		250°F (121°C)	STC40CS	ferrule	100
	Ambient	150-C/E	sleeve	250		Ambient	400-C/E	sleeve	110
	160°F (71°C)	150-C/E	sleeve	200		160°F (71°C)	400-C/E	sleeve	75
	180°F (82°C)	150-C/E	sleeve	100		180°F (82°C)	400-C/E	sleeve	60
	250°F (121°C)	150-C/E	sleeve	75		250°F (121°C)	400-C/E	sleeve	50
	Ambient	150-C/E	ferrule	250		Ambient	400-C/E	ferrule	150
	160°F (71°C)	150-C/E	ferrule	200		160°F (71°C)	400-C/E	ferrule	75
	180°F (82°C)	150-C/E	ferrule	150		180°F (82°C)	400-C/E	ferrule	75
250°F (121°C)	150-C/E	ferrule	100	250°F (121°C)	400-C/E	ferrule	75		
2"	Ambient	STC25CS	sleeve	250	6"	Ambient	STC60CS	sleeve	75
	160°F (71°C)	STC25CS	sleeve	150		160°F (71°C)	STC60CS	sleeve	---
	180°F (82°C)	STC25CS	sleeve	125		180°F (82°C)	STC60CS	sleeve	---
	250°F (121°C)	STC25CS	sleeve	80		250°F (121°C)	STC60CS	sleeve	---
	Ambient	STC25CS	ferrule	300		Ambient	STC60CS	ferrule	230
	160°F (71°C)	STC25CS	ferrule	239		160°F (71°C)	STC60CS	ferrule	---
	180°F (82°C)	STC25CS	ferrule	225		180°F (82°C)	STC60CS	ferrule	---
	250°F (121°C)	STC25CS	ferrule	100		250°F (121°C)	STC60CS	ferrule	---
	Ambient	200-C/E	sleeve	250		Ambient	600-C/E	sleeve	75
	160°F (71°C)	200-C/E	sleeve	100		160°F (71°C)	600-C/E	sleeve	---
	180°F (82°C)	200-C/E	sleeve	50		180°F (82°C)	600-C/E	sleeve	---
	250°F (121°C)	200-C/E	sleeve	50		250°F (121°C)	600-C/E	sleeve	---
	Ambient	200-C/E	ferrule	250		Ambient	600-C/E	ferrule	75
	160°F (71°C)	200-C/E	ferrule	100		160°F (71°C)	600-C/E	ferrule	---
	180°F (82°C)	200-C/E	ferrule	100		180°F (82°C)	600-C/E	ferrule	---
250°F (121°C)	200-C/E	ferrule	100	250°F (121°C)	600-C/E	ferrule	---		

Dixon® Cam & Groove Type C Coupler x Hose Shank

Features:

- Finger rings are not supplied on 1" Dixon® couplings.
- Couplers are supplied standard with a Buna-N gasket. Other gasket types are available on pages D-48 to D-50
- ½" Dixon® coupler has only one cam arm.
- Use Dixon® replacement handles only

Hose ID	356T6 Aluminum		Brass		316 Stainless Steel		Unplated Ductile Iron	
	Part #	Price/E	Part #	Price/E	Part #	Price/E	Part #	Price/E
1"	100-C-AL	\$28.70	100-C-BR	\$62.05	100-C-SS	\$79.30	---	---
1½"	150-C-AL	36.50	150-C-BR	83.60	150-C-SS	96.60	150-C-MI	\$51.55
2"	200-C-AL	37.95	200-C-BR	109.05	200-C-SS	114.25	200-C-MI	54.00
3"	300-C-AL	60.00	300-C-BR	189.00	300-C-SS	198.70	300-C-MI ¹	87.00
4"	400-C-AL	81.60	400-C-BR	238.00	400-C-SS	336.00	400-C-MI ¹	112.20
6"	600-C-AL	195.95	600-C-BR	814.90	600-C-SS	548.00	600-C-MI ¹	210.00

¹ ductile iron

Only use the crimp style shanks with the crimp style sleeves and ferrules.

Due to differences in dimensions and tolerances for safety reasons, do not interchange other manufacturer's products with Dixon® products.



356T6 aluminum



brass



316 stainless steel



unplated ductile iron

EZ Boss-Lock™ Cam & Groove Type C Coupler x Hose Shank

Features:

- Couplers are supplied standard with a Buna-N gasket. Other gasket types are available on pages D-48 to D-50.

Size	316 Stainless Steel	
	Part #	Price/E
1"	RC100EZCR	\$110.80
1¼"	RC125EZCR	163.80
1½"	RC150EZCR	115.00
2"	RC200EZCR	125.50
3"	RC300EZCR	210.00
4"	RC400EZCR	315.00
6"	RC600EZCR	599.00



Under no circumstances should the EZ Boss-Lock™ cam arms be used on any fitting not specifically designed for their use. See page D-3 for further specifications.



Dixon® Type E Adapters

male adapter x hose shank



356T6 aluminum



brass



316 stainless steel



unplated ductile iron



Pressure rating is based on the seal of the mating part. See ratings on page D-5.

Hose ID	356T6 Aluminum		Brass		316 Stainless Steel		Unplated Ductile Iron	
	Part #	Price/E	Part #	Price/E	Part #	Price/E	Part #	Price/E
1"	100-E-AL	\$18.10	100-E-BR	\$42.50	100-E-SS	\$51.00	---	---
1½"	150-E-AL	21.00	150-E-BR	64.85	150-E-SS	72.35	---	---
2"	200-E-AL	24.20	200-E-BR	89.50	200-E-SS	76.35	---	---
3"	300-E-AL	38.85	300-E-BR	146.55	300-E-SS	141.50	300-E-MI	\$53.20
4"	400-E-AL	70.95	400-E-BR	243.00	400-E-SS	278.00	400-E-MI	86.35
6"	600-E-AL	147.70	600-E-BR	715.25	600-E-SS	554.00	600-E-MI	184.80

Global Crimp Style Cam & Groove Type C Coupler x Hose Shank



A380 permanent mold aluminum



C38000 forged brass



316 investment cast stainless

Features:

- All couplers are supplied with safety clips.
- Couplers are supplied standard with a Buna-N gasket. Other gasket types are available on pages D-48 to D-50.
- Use Global replacement handles only



Only use the crimp style shanks with the crimp style sleeves and ferrules. Due to differences in dimensions and tolerances for safety reasons, do not interchange other manufacturer's products with Dixon® products.

Hose ID	A380 Permanent Mold Aluminum		C38000 Forged Brass		316 Investment Cast Stainless	
	Part #	Price/E	Part #	Price/E	Part #	Price/E
1"	G100-C-ALCR	\$14.05	G100-C-BRCR	\$31.00	G100-C-SSCR	\$36.60
1½"	G150-C-ALCR	19.45	G150-C-BRCR	47.25	G150-C-SSCR	55.45
2"	G200-C-ALCR	22.95	G200-C-BRCR	60.50	G200-C-SSCR	77.40
3"	G300-C-ALCR	37.50	G300-C-BRCR	126.30	G300-C-SSCR	140.15
4"	G400-C-ALCR	51.85	G400-C-BRCR	173.50	G400-C-SSCR	181.70
6"	G600-C-ALCR	137.00	---	---	G600-C-SSCR	485.00

Global Crimp Style Cam & Groove Type E Adapter x Hose Shank

Only use the crimp style shanks with the crimp style sleeves and ferrules.

Due to differences in dimensions and tolerances for safety reasons, do not interchange other manufacturer's products with Dixon® products. Pressure rating is based on the seal of the mating part. See ratings on page D-5.



A380 permanent mold aluminum

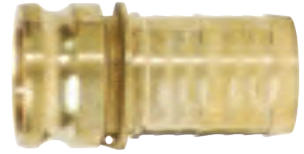

C38000 forged brass



316 investment cast stainless

Hose ID	A380 Permanent Mold Aluminum		C38000 Forged Brass		316 Investment Cast Stainless Steel	
	Part #	Price/E	Part #	Price/E	Part #	Price/E
1"	G100-E-ALCR	\$7.55	G100-E-BRCR	\$23.00	G100-E-SSCR	\$28.40
1½"	G150-E-ALCR	11.45	G150-E-BRCR	37.60	G150-E-SSCR	44.95
2"	G200-E-ALCR	13.95	G200-E-BRCR	52.25	G200-E-SSCR	61.90
3"	G300-E-ALCR	23.45	G300-E-BRCR	108.35	G300-E-SSCR	117.95
4"	G400-E-ALCR	37.20	G400-E-BRCR	153.10	G400-E-SSCR	167.15
6"	G600-E-ALCR	105.00	---	---	G600-E-SSCR	472.00

Boss™ Ground Joint Stems

Only use the crimp style shanks with the crimp style sleeves and ferrules.

Due to differences in dimensions and tolerances for safety reasons, do not interchange other manufacturer's products with Dixon® products. Pressure rating is based on the seal of the mating part. See ratings on page D-5.



Hose Shank x NPT	Plated Steel and / or Iron		Opt Qty
	Part #	Price/E	
2"	GB26	\$26.25	10
3"	GB36	90.00	5



- GB26 and GB36 has a machined shank to accept a Boss™ clamp, King Crimp™ sleeve or a ferrule

The King Crimp™ sleeve and ferrule are not intended for steam service.





King Crimp™ Style Sleeves

Only use the crimp style shanks with the crimp style sleeves and ferrules. Due to differences in dimensions and tolerances for safety reasons, do not interchange other manufacturer's products with Dixon® products.

Coupling Systems

Hose ID	Hose OD		Work. Pressure (PSI)		Sleeve ID	Sleeve Wall Thick.	Sleeve Overall Length	Carbon Steel		304 Stainless Steel		Aluminum	
	From	To	cam & groove ¹	KC nipple ²				Part #	Price	Part #	Price	Part #	Price
1"	1-13/64"	1-16/64"	*	*	1.313"	.062"	2½"	CS100-1CS	\$4.70	CS100-1SS	\$7.15	---	---
	1-17/64"	1-20/64"	*	*	1.375"	.062"	2½"	CS100-2CS	4.70	CS100-2SS	7.15	CS100-2AL	\$7.60
	1-21/64"	1-24/64"	*	*	1.438"	.062"	2½"	CS100-3CS	4.70	CS100-3SS	7.15	---	---
	1-25/64"	1-28/64"	*	*	1.500"	.062"	2½"	CS100-4CS	4.70	CS100-4SS	7.15	CS100-4AL	7.60
	1-29/64"	1-32/64"	*	*	1.563"	.062"	2½"	CS100-5CS	4.70	CS100-5SS	7.15	---	---
	1-33/64"	1-36/64"	*	*	1.625"	.062"	2½"	CS100-6CS	4.70	CS100-6SS	7.15	CS100-6AL	7.60
	1-37/64"	1-40/64"	*	*	1.688"	.062"	2½"	CS100-7CS	4.70	CS100-7SS	7.15	---	---
	1-41/64"	1-44/64"	*	*	1.750"	.062"	2½"	CS100-8CS	4.70	CS100-8SS	7.15	---	---
	1-45/64"	1-48/64"	*	*	1.813"	.062"	2½"	CS100-9CS	4.70	CS100-9SS	7.15	---	---
	1-49/64"	1-52/64"	*	*	1.875"	.062"	2½"	CS100-10CS	4.70	CS100-10SS	7.15	---	---
1¼"	1-41/64"	1-44/64"	250	300	1.750"	.060"	2-5/8"	CS125-3CS	4.80	CS125-3SS	8.60	---	---
	1-45/64"	1-48/64"	250	300	1.813"	.060"	2-5/8"	CS125-4CS	4.80	CS125-4SS	8.60	---	---
	1-49/64"	1-52/64"	250	300	1.875"	.060"	2-5/8"	CS125-5CS	4.80	CS125-5SS	8.60	---	---
	1-53/64"	1-56/64"	250	300	1.938"	.060"	2-5/8"	CS125-6CS	4.80	CS125-6SS	8.60	---	---
1½"	1-41/64"	1-44/64"	250	300	1.750"	.062"	2½"	CS150-1CS	4.85	CS150-1SS	8.50	---	---
	1-45/64"	1-48/64"	250	300	1.813"	.062"	2½"	CS150-2CS	4.85	CS150-2SS	8.50	---	---
	1-49/64"	1-52/64"	250	300	1.875"	.062"	2½"	CS150-3CS	4.85	CS150-3SS	8.50	CS150-3AL	10.00
	1-53/64"	1-56/64"	250	300	1.938"	.062"	2½"	CS150-4CS	4.85	CS150-4SS	8.50	---	---
	1-57/64"	1-60/64"	250	300	2.000"	.062"	2½"	CS150-5CS	4.85	CS150-5SS	8.50	---	---
	1-61/64"	2"	250	300	2.063"	.062"	2½"	CS150-6CS	4.85	CS150-6SS	8.50	---	---
	2-1/64"	2-4/64"	250	300	2.125"	.062"	2½"	CS150-7CS	4.85	CS150-7SS	8.50	CS150-7AL	10.00
	2-5/64"	2-8/64"	250	300	2.188"	.062"	2½"	CS150-8CS	4.85	CS150-8SS	8.50	---	---
	2-9/64"	2-12/64"	250	300	2.250"	.062"	2½"	CS150-9CS	4.85	CS150-9SS	8.50	---	---
	2-13/64"	2-16/64"	250	300	2.313"	.062"	2½"	CS150-10CS	4.85	CS150-10SS	8.50	---	---
2"	2-17/64"	2-20/64"	250	300	2.375"	.062"	2½"	CS150-11CS	4.85	CS150-11SS	8.50	---	---
	2-21/64"	2-24/64"	250	300	2.438"	.062"	2½"	CS150-12CS	4.85	CS150-12SS	8.50	---	---
	2-13/64"	2-16/64"	250	250	2.313"	.062"	2-7/8"	CS200-1CS	5.70	CS200-1SS	11.75	---	---
	2-17/64"	2-20/64"	250	250	2.375"	.062"	2-7/8"	CS200-2CS	5.70	CS200-2SS	11.75	---	---
	2-21/64"	2-24/64"	250	250	2.438"	.062"	2-7/8"	CS200-3CS	5.70	CS200-3SS	11.75	---	---
	2-25/64"	2-28/64"	250	250	2.500"	.062"	2-7/8"	CS200-4CS	5.70	CS200-4SS	11.75	CS200-4AL	12.70
	2-29/64"	2-32/64"	250	250	2.563"	.062"	2-7/8"	CS200-5CS	5.70	CS200-5SS	11.75	---	---
	2-33/64"	2-36/64"	250	250	2.625"	.062"	2-7/8"	CS200-6CS	5.70	CS200-6SS	11.75	---	---
	2-37/64"	2-40/64"	250	250	2.688"	.062"	2-7/8"	CS200-7CS	5.70	CS200-7SS	11.75	---	---
	2-41/64"	2-44/64"	250	250	2.750"	.062"	2-7/8"	CS200-8CS	5.70	CS200-8SS	11.75	---	---
	2-45/64"	2-48/64"	250	250	2.813"	.062"	2-7/8"	CS200-9CS	5.70	CS200-9SS	11.75	---	---
	2-49/64"	2-52/64"	250	250	2.875"	.062"	2-7/8"	CS200-10CS	5.70	CS200-10SS	11.75	CS200-10AL	12.70
2-53/64"	2-56/64"	250	250	2.938"	.062"	2-7/8"	CS200-11CS	5.70	CS200-11SS	11.75	---	---	
2-57/64"	2-60/64"	250	250	3.000"	.062"	2-7/8"	CS200-12CS	5.70	CS200-12SS	11.75	---	---	

* consult Dixon® at engineering@dixonvalve.com for pressure rating

¹ based on using crimp cam & groove shanks

² based on using King™ combination nipples

King Crimp™ Style Sleeves

Only use the crimp style shanks with the crimp style sleeves and ferrules. Due to differences in dimensions and tolerances for safety reasons, do not interchange other manufacturer's products with Dixon® products.



Hose ID	Hose OD		Work. Pressure (PSI)		Sleeve ID	Sleeve Wall Thick.	Sleeve Overall Length	Carbon Steel		304 Stainless Steel		Aluminum	
	From	To	cam & groove ¹	KC nipple ²				Part #	Price	Part #	Price	Part #	Price
3"	3-13/64"	3-16/64"	125	200	3.313"	.090"	3¾"	CS300-1CS	\$10.35	CS300-1SS	\$17.05	---	---
	3-17/64"	3-20/64"	125	200	3.375"	.090"	3¾"	CS300-2CS	10.35	CS300-2SS	17.05	---	---
	3-21/64"	3-24/64"	125	200	3.438"	.090"	3¾"	CS300-3CS	10.35	CS300-3SS	17.05	---	---
	3-25/64"	3-28/64"	125	200	3.500"	.090"	3¾"	CS300-4CS	10.35	CS300-4SS	17.05	---	---
	3-29/64"	3-32/64"	125	200	3.563"	.090"	3¾"	CS300-5CS	10.35	CS300-5SS	17.05	CS300-5AL	\$11.80
	3-33/64"	3-36/64"	125	200	3.625"	.090"	3¾"	CS300-6CS	10.35	CS300-6SS	17.05	---	---
	3-37/64"	3-40/64"	125	200	3.688"	.090"	3¾"	CS300-7CS	10.35	CS300-7SS	17.05	---	---
	3-41/64"	3-44/64"	125	200	3.750"	.090"	3¾"	CS300-8CS	10.35	CS300-8SS	17.05	CS300-8AL	11.80
	3-45/64"	3-48/64"	125	200	3.813"	.090"	3¾"	CS300-9CS	10.35	CS300-9SS	17.05	---	---
	3-49/64"	3-52/64"	125	200	3.875"	.090"	3¾"	CS300-10CS	10.35	CS300-10SS	17.05	---	---
	3-53/64"	3-56/64"	125	200	3.938"	.090"	3¾"	CS300-11CS	10.35	CS300-11SS	17.05	---	---
	3-57/64"	3-60/64"	125	200	4.000"	.090"	3¾"	CS300-12CS	10.35	CS300-12SS	17.05	CS300-12AL	11.80
	3-61/64"	4"	125	200	4.063"	.090"	3¾"	CS300-13CS	10.35	CS300-13SS	17.05	---	---
	4-1/64"	4-4/64"	125	200	4.125"	.090"	3¾"	CS300-14CS	10.35	CS300-14SS	17.05	---	---
	4-5/64"	4-8/64"	125	200	4.188"	.090"	3¾"	CS300-15CS	10.35	CS300-15SS	17.05	---	---
	4-9/64"	4-12/64"	125	200	4.250"	.090"	3¾"	CS300-16CS	10.35	CS300-16SS	17.05	---	---
4"	4-13/64"	4-16/64"	110	175	4.313"	.090"	3¾"	CS400-1CS	13.90	CS400-1SS	28.35	---	---
	4-17/64"	4-20/64"	110	175	4.375"	.090"	3¾"	CS400-2CS	13.90	CS400-2SS	28.35	---	---
	4-21/64"	4-24/64"	110	175	4.438"	.090"	3¾"	CS400-3CS	13.90	CS400-3SS	28.35	---	---
	4-25/64"	4-28/64"	110	175	4.500"	.090"	3¾"	CS400-4CS	13.90	CS400-4SS	28.35	---	---
	4-29/64"	4-32/64"	110	175	4.563"	.090"	3¾"	CS400-5CS	13.90	CS400-5SS	28.35	---	---
	4-33/64"	4-36/64"	110	175	4.625"	.090"	3¾"	CS400-6CS	13.90	CS400-6SS	28.35	---	---
	4-37/64"	4-40/64"	110	175	4.688"	.090"	3¾"	CS400-7CS	13.90	CS400-7SS	28.35	---	---
	4-41/64"	4-44/64"	110	175	4.750"	.090"	3¾"	CS400-8CS	13.90	CS400-8SS	28.35	---	---
	4-45/64"	4-48/64"	110	175	4.813"	.090"	3¾"	CS400-9CS	13.90	CS400-9SS	28.35	---	---
	4-49/64"	4-52/64"	110	175	4.875"	.090"	3¾"	CS400-10CS	13.90	CS400-10SS	28.35	CS400-10AL	14.40
	4-53/64"	4-56/64"	110	175	4.938"	.090"	3¾"	CS400-11CS	13.90	CS400-11SS	28.35	---	---
	4-57/64"	4-60/64"	110	175	5.000"	.090"	3¾"	CS400-12CS	13.90	CS400-12SS	28.35	CS400-12AL	14.40
	4-61/64"	5"	110	175	5.063"	.090"	3¾"	CS400-13CS	13.90	CS400-13SS	28.35	---	---
	5-1/64"	5-4/64"	110	175	5.125"	.090"	3¾"	CS400-14CS	13.90	CS400-14SS	28.35	---	---
	5-5/64"	5-8/64"	110	175	5.188"	.090"	3¾"	CS400-15CS	13.90	CS400-15SS	28.35	---	---
	5-9/64"	5-12/64"	110	175	5.250"	.090"	3¾"	CS400-16CS	13.90	CS400-16SS	28.35	---	---
6"	6-21/64"	6-28/64"	*	*	6.500"	.120"	5½"	CS600-1CS	37.90	CS600-1SS	72.75	---	---
	6-29/64"	6-36/64"	*	*	6.625"	.120"	5½"	CS600-2CS	37.90	CS600-2SS	72.75	---	---
	6-37/64"	6-44/64"	*	*	6.750"	.120"	5½"	CS600-3CS	37.90	CS600-3SS	72.75	---	---
	6-45/64"	6-52/64"	*	*	6.875"	.120"	5½"	CS600-4CS	37.90	CS600-4SS	72.75	---	---
	6-53/64"	6-60/64"	*	*	7.000"	.120"	5½"	CS600-5CS	37.90	CS600-5SS	72.75	---	---
	6-61/64"	7-4/64"	*	*	7.125"	.120"	5½"	CS600-6CS	37.90	CS600-6SS	72.75	---	---
	7-5/64"	7-12/64"	*	*	7.250"	.120"	5½"	CS600-7CS	37.90	CS600-7SS	72.75	---	---
	7-13/64"	7-20/64"	*	*	7.375"	.120"	5½"	CS600-8CS	37.90	CS600-8SS	72.75	---	---
	7-21/64"	7-28/64"	*	*	7.500"	.120"	5½"	CS600-9CS	37.90	CS600-9SS	72.75	---	---

* consult Dixon® at engineering@dixonvalve.com for pressure rating

¹ based on using crimp cam & groove shanks

² based on using King™ combination nipples

King Crimp™ Style Ferrules



Only use the crimp style shanks with the crimp style sleeves and ferrules. Due to differences in dimensions and tolerances for safety reasons, do not interchange other manufacturer's products with Dixon® products.

Hose ID	Hose OD		Work. Pressure (PSI)		Ferrule ID	Ferrule Wall Thickness	Ferrule Overall Length	Carbon Steel		304 Stainless Steel	
	From	To	cam & groove ¹	KC nipple ²				Part #	Price	Part #	Price
1"	1-13/64"	1-16/64"	*	*	1.313"	.062"	2-13/16"	CF100-1CS	\$10.00	CF100-1SS	\$10.15
	1-17/64"	1-20/64"	*	*	1.375"	.062"	2-13/16"	CF100-2CS	10.00	CF100-2SS	10.15
	1-21/64"	1-24/64"	*	*	1.438"	.062"	2-13/16"	CF100-3CS	10.00	CF100-3SS	10.15
	1-25/64"	1-28/64"	*	*	1.500"	.062"	2-13/16"	CF100-4CS	10.00	CF100-4SS	10.15
	1-29/64"	1-32/64"	*	*	1.563"	.062"	2-13/16"	CF100-5CS	10.00	CF100-5SS	10.15
	1-33/64"	1-36/64"	*	*	1.625"	.062"	2-13/16"	CF100-6CS	10.00	CF100-6SS	10.15
	1-37/64"	1-40/64"	*	*	1.688"	.062"	2-13/16"	CF100-7CS	10.00	CF100-7SS	10.15
	1-41/64"	1-44/64"	*	*	1.750"	.062"	2-13/16"	CF100-8CS	10.00	CF100-8SS	10.15
	1-45/64"	1-48/64"	*	*	1.813"	.062"	2-13/16"	CF100-9CS	10.00	CF100-9SS	10.15
	1-49/64"	1-52/64"	*	*	1.875"	.062"	2-13/16"	CF100-10CS	10.00	CF100-10SS	10.15
1¼"	1-41/64"	1-44/64"	250	350	1.750"	.060"	2-13/16"	CF125-3CS	10.25	CF125-3SS	12.00
	1-45/64"	1-48/64"	250	350	1.813"	.060"	2-13/16"	CF125-4CS	10.25	CF125-4SS	12.00
	1-49/64"	1-52/64"	250	350	1.875"	.060"	2-13/16"	CF125-5CS	10.25	CF125-5SS	12.00
	1-53/64"	1-56/64"	250	350	1.938"	.060"	2-13/16"	CF125-6CS	10.25	CF125-6SS	12.00
1½"	1-41/64"	1-44/64"	250	350	1.750"	.062"	2-13/16"	CF150-1CS	11.40	CF150-1SS	15.60
	1-45/64"	1-48/64"	250	350	1.813"	.062"	2-13/16"	CF150-2CS	11.40	CF150-2SS	15.60
	1-49/64"	1-52/64"	250	350	1.875"	.062"	2-13/16"	CF150-3CS	11.40	CF150-3SS	15.60
	1-53/64"	1-56/64"	250	350	1.938"	.062"	2-13/16"	CF150-4CS	11.40	CF150-4SS	15.60
	1-57/64"	1-60/64"	250	350	2.000"	.062"	2-13/16"	CF150-5CS	11.40	CF150-5SS	15.60
	1-61/64"	2"	250	350	2.063"	.062"	2-13/16"	CF150-6CS	11.40	CF150-6SS	15.60
	2-1/64"	2-4/64"	250	350	2.125"	.062"	2-13/16"	CF150-7CS	11.40	CF150-7SS	15.60
	2-5/64"	2-8/64"	250	350	2.188"	.062"	2-13/16"	CF150-8CS	11.40	CF150-8SS	15.60
	2-9/64"	2-12/64"	250	350	2.250"	.062"	2-13/16"	CF150-9CS	11.40	CF150-9SS	15.60
	2-13/64"	2-16/64"	250	350	2.313"	.062"	2-13/16"	CF150-10CS	11.40	CF150-10SS	15.60
2-17/64"	2-20/64"	250	350	2.375"	.062"	2-13/16"	CF150-11CS	11.40	CF150-11SS	15.60	
2-21/64"	2-24/64"	250	350	2.438"	.062"	2-13/16"	CF150-12CS	11.40	CF150-12SS	15.60	
2"	2-13/64"	2-16/64"	250	300	2.313"	.062"	3-1/8"	CF200-1CS	12.95	CF200-1SS	17.65
	2-17/64"	2-20/64"	250	300	2.375"	.062"	3-1/8"	CF200-2CS	12.95	CF200-2SS	17.65
	2-21/64"	2-24/64"	250	300	2.438"	.062"	3-1/8"	CF200-3CS	12.95	CF200-3SS	17.65
	2-25/64"	2-28/64"	250	300	2.500"	.062"	3-1/8"	CF200-4CS	12.95	CF200-4SS	17.65
	2-29/64"	2-32/64"	250	300	2.563"	.062"	3-1/8"	CF200-5CS	12.95	CF200-5SS	17.65
	2-33/64"	2-36/64"	250	300	2.625"	.062"	3-1/8"	CF200-6CS	12.95	CF200-6SS	17.65
	2-37/64"	2-40/64"	250	300	2.688"	.062"	3-1/8"	CF200-7CS	12.95	CF200-7SS	17.65
	2-41/64"	2-44/64"	250	300	2.750"	.062"	3-1/8"	CF200-8CS	12.95	CF200-8SS	17.65
	2-45/64"	2-48/64"	250	300	2.813"	.062"	3-1/8"	CF200-9CS	12.95	CF200-9SS	17.65
	2-49/64"	2-52/64"	250	300	2.875"	.062"	3-1/8"	CF200-10CS	12.95	CF200-10SS	17.65
	2-53/64"	2-56/64"	250	300	2.938"	.062"	3-1/8"	CF200-11CS	12.95	CF200-11SS	17.65
	2-57/64"	2-60/64"	250	300	3.000"	.062"	3-1/8"	CF200-12CS	12.95	CF200-12SS	17.65

* consult Dixon® at engineering@dixonvalve.com for pressure rating

¹ based on using crimp cam & groove shanks

² based on using King™ combination nipples

King Crimp™ Style Ferrules

Only use the crimp style shanks with the crimp style sleeves and ferrules. Due to differences in dimensions and tolerances for safety reasons, do not interchange other manufacturer's products with Dixon® products.



Hose ID	Hose OD		Work. Pressure (PSI)		Ferrule ID	Ferrule Wall Thickness	Ferrule Overall Length	Carbon Steel		304 Stainless Steel	
	From	To	cam & groove ¹	KC nipple ²				Part #	Price	Part #	Price
3"	3-13/64"	3-16/64"	150	300	3.313"	.090"	4"	CF300-1CS	\$17.85	CF300-1SS	\$28.95
	3-17/64"	3-20/64"	150	300	3.375"	.090"	4"	CF300-2CS	17.85	CF300-2SS	28.95
	3-21/64"	3-24/64"	150	300	3.438"	.090"	4"	CF300-3CS	17.85	CF300-3SS	28.95
	3-25/64"	3-28/64"	150	300	3.500"	.090"	4"	CF300-4CS	17.85	CF300-4SS	28.95
	3-29/64"	3-32/64"	150	300	3.563"	.090"	4"	CF300-5CS	17.85	CF300-5SS	28.95
	3-33/64"	3-36/64"	150	300	3.625"	.090"	4"	CF300-6CS	17.85	CF300-6SS	28.95
	3-37/64"	3-40/64"	150	300	3.688"	.090"	4"	CF300-7CS	17.85	CF300-7SS	28.95
	3-41/64"	3-44/64"	150	300	3.750"	.090"	4"	CF300-8CS	17.85	CF300-8SS	28.95
	3-45/64"	3-48/64"	150	300	3.813"	.090"	4"	CF300-9CS	17.85	CF300-9SS	28.95
	3-49/64"	3-52/64"	150	300	3.875"	.090"	4"	CF300-10CS	17.85	CF300-10SS	28.95
	3-53/64"	3-56/64"	150	300	3.938"	.090"	4"	CF300-11CS	17.85	CF300-11SS	28.95
	3-57/64"	3-60/64"	150	300	4.000"	.090"	4"	CF300-12CS	17.85	CF300-12SS	28.95
	3-61/64"	4"	150	300	4.063"	.090"	4"	CF300-13CS	17.85	CF300-13SS	28.95
	4-1/64"	4-4/64"	150	300	4.125"	.090"	4"	CF300-14CS	17.85	CF300-14SS	28.95
	4-5/64"	4-8/64"	150	300	4.188"	.090"	4"	CF300-15CS	17.85	CF300-15SS	28.95
	4-9/64"	4-12/64"	150	300	4.250"	.090"	4"	CF300-16CS	17.85	CF300-16SS	28.95
4"	4-13/64"	4-16/64"	150	300	4.313"	.090"	4"	CF400-1CS	23.50	CF400-1SS	67.20
	4-17/64"	4-20/64"	150	300	4.375"	.090"	4"	CF400-2CS	23.50	CF400-2SS	67.20
	4-21/64"	4-24/64"	150	300	4.438"	.090"	4"	CF400-3CS	23.50	CF400-3SS	67.20
	4-25/64"	4-28/64"	150	300	4.500"	.090"	4"	CF400-4CS	23.50	CF400-4SS	67.20
	4-29/64"	4-32/64"	150	300	4.563"	.090"	4"	CF400-5CS	23.50	CF400-5SS	67.20
	4-33/64"	4-36/64"	150	300	4.625"	.090"	4"	CF400-6CS	23.50	CF400-6SS	67.20
	4-37/64"	4-40/64"	150	300	4.688"	.090"	4"	CF400-7CS	23.50	CF400-7SS	67.20
	4-41/64"	4-44/64"	150	300	4.750"	.090"	4"	CF400-8CS	23.50	CF400-8SS	67.20
	4-45/64"	4-48/64"	150	300	4.813"	.090"	4"	CF400-9CS	23.50	CF400-9SS	67.20
	4-49/64"	4-52/64"	150	300	4.875"	.090"	4"	CF400-10CS	23.50	CF400-10SS	67.20
	4-53/64"	4-56/64"	150	300	4.938"	.090"	4"	CF400-11CS	23.50	CF400-11SS	67.20
	4-57/64"	4-60/64"	150	300	5.000"	.090"	4"	CF400-12CS	23.50	CF400-12SS	67.20
	4-61/64"	5"	150	300	5.063"	.090"	4"	CF400-13CS	23.50	CF400-13SS	67.20
	5-1/64"	5-4/64"	150	300	5.125"	.090"	4"	CF400-14CS	23.50	CF400-14SS	67.20
	5-5/64"	5-8/64"	150	300	5.188"	.090"	4"	CF400-15CS	23.50	CF400-15SS	67.20
	5-9/64"	5-12/64"	150	300	5.250"	.090"	4"	CF400-16CS	23.50	CF400-16SS	67.20
6"	6-21/64"	6-28/64"	*	*	6.500"	.120"	5-7/8"	CF600-1CS	52.25	CF600-1SS	85.00
	6-29/64"	6-36/64"	*	*	6.625"	.120"	5-7/8"	CF600-2CS	52.25	CF600-2SS	85.00
	6-37/64"	6-44/64"	*	*	6.750"	.120"	5-7/8"	CF600-3CS	52.25	CF600-3SS	85.00
	6-45/64"	6-52/64"	*	*	6.875"	.120"	5-7/8"	CF600-4CS	52.25	CF600-4SS	85.00
	6-53/64"	6-60/64"	*	*	7.000"	.120"	5-7/8"	CF600-5CS	52.25	CF600-5SS	85.00
	6-61/64"	7-4/64"	*	*	7.125"	.120"	5-7/8"	CF600-6CS	52.25	CF600-6SS	85.00
	7-5/64"	7-12/64"	*	*	7.250"	.120"	5-7/8"	CF600-7CS	52.25	CF600-7SS	85.00
	7-13/64"	7-20/64"	*	*	7.375"	.120"	5-7/8"	CF600-8CS	52.25	CF600-8SS	85.00
	7-21/64"	7-28/64"	*	*	7.500"	.120"	5-7/8"	CF600-9CS	52.25	CF600-9SS	85.00

* consult Dixon® at engineering@dixonvalve.com for pressure rating

¹ based on using crimp cam & groove shanks

² based on using King Crimp™ combination nipples

Crimp Working Pressure Chart

Coupling Systems

Size	Temperature	Fitting	Clamp	Working Pressure (PSI)
1"	Ambient	STC10CS	sleeve	400
	160°F (71°C)	STC10CS	sleeve	270
	180°F (82°C)	STC10CS	sleeve	250
	250°F (121°C)	STC10CS	sleeve	200
	Ambient	STC10CS	ferrule	400
	160°F (71°C)	STC10CS	ferrule	270
	180°F (82°C)	STC10CS	ferrule	250
	250°F (121°C)	STC10CS	ferrule	200
1½"	Ambient	STC20CS	sleeve	300
	160°F (71°C)	STC20CS	sleeve	225
	180°F (82°C)	STC20CS	sleeve	200
	250°F (121°C)	STC20CS	sleeve	100
	Ambient	STC20CS	ferrule	350
	160°F (71°C)	STC20CS	ferrule	225
	180°F (82°C)	STC20CS	ferrule	200
	250°F (121°C)	STC20CS	ferrule	150
2"	Ambient	STC25CS	sleeve	250
	160°F (71°C)	STC25CS	sleeve	150
	180°F (82°C)	STC25CS	sleeve	125
	250°F (121°C)	STC25CS	sleeve	80
	Ambient	STC25CS	ferrule	300
	160°F (71°C)	STC25CS	ferrule	239
	180°F (82°C)	STC25CS	ferrule	225
	250°F (121°C)	STC25CS	ferrule	100
3"	Ambient	STC35CS	sleeve	200
	160°F (71°C)	STC35CS	sleeve	140
	180°F (82°C)	STC35CS	sleeve	100
	250°F (121°C)	STC35CS	sleeve	75
	Ambient	STC35CS	ferrule	300
	160°F (71°C)	STC35CS	ferrule	218
	180°F (82°C)	STC35CS	ferrule	200
	250°F (121°C)	STC35CS	ferrule	100
4"	Ambient	STC40CS	sleeve	175
	160°F (71°C)	STC40CS	sleeve	100
	180°F (82°C)	STC40CS	sleeve	100
	250°F (121°C)	STC40CS	sleeve	50
	Ambient	STC40CS	ferrule	300
	160°F (71°C)	STC40CS	ferrule	218
	180°F (82°C)	STC40CS	ferrule	200
	250°F (121°C)	STC40CS	ferrule	100
6"	Ambient	STC60CS	sleeve	75
	160°F (71°C)	STC60CS	sleeve	---
	180°F (82°C)	STC60CS	sleeve	---
	250°F (121°C)	STC60CS	sleeve	---
	Ambient	STC60CS	ferrule	230
	160°F (71°C)	STC60CS	ferrule	---
	180°F (82°C)	STC60CS	ferrule	---
	250°F (121°C)	STC60CS	ferrule	---

King Crimp™ Style Combination Nipples - Threaded End

Features:

- There are two grooves on the crimp style King™ Combination nipples. The second groove is the roll stamp groove which has the part number and 'call Dixon®' stamped on it. This groove is a smooth concentric groove so that the stamp is legible.

Hose ID	Schedule 80 Plated Carbon Steel		316 Stainless Steel	
	Part #	Price/E	Part #	Price/E
1"	STC10CS	\$22.85	RST10CS	\$36.50
1¼"	STC15CS	23.20	RST15CS	49.00
1½"	STC20CS	11.10	RST20CS	51.50
2"	STC25CS	27.00	RST25CS	63.70
3"	STC35CS	51.50	RST35CS	140.00
4"	STC40CS	63.65	RST40CS	206.00
6"	STC60CS	134.85	RST60CS	745.00

* for 8" options see page B-49



King Crimp™ Style Combination Nipples - Grooved End

Features:

- There are two grooves on the crimp style King™ Combination nipples. The second groove is the roll stamp groove which has the part number and 'call Dixon®' stamped on it. This groove is a smooth concentric groove so that the stamp is legible.

Hose ID	Schedule 80 Plated Carbon Steel		316 Stainless Steel	
	Part #	Price/E	Part #	Price/E
1"	STV10CS	\$24.00	RSTV10CS	\$44.00
1½"	STV20CS	30.30	RSTV20CS	65.15
2"	STV25CS	36.35	RSTV25CS	80.30
3"	STV35CS	65.15	RSTV35CS	190.90
4"	STV40CS	78.80	RSTV40CS	250.75
6"	STV60CS	162.00	RSTV60CS	770.00



King Crimp™ Style Combination Nipples - Beveled End

Features:

- There are two grooves on the crimp style King™ Combination nipples. The second groove is the roll stamp groove which has the part number and 'call Dixon®' stamped on it. This groove is a smooth concentric groove so that the stamp is legible.

Hose ID	Schedule 80 Carbon Steel		316 Stainless Steel	
	Part #	Price/E	Part #	Price/E
1"	STB10CS	\$23.70	RSTB10CS	\$43.00
1½"	STB20CS	23.00	RSTB20CS	53.00
2"	STB25CS	27.30	RSTB25CS	79.00
3"	STB35CS	49.50	RSTB35CS	189.00
4"	STB40CS	62.55	RSTB40CS	250.00
6"	STB60CS	134.00	RSTB60CS	740.00

- For additional information on pipe dimensions please reference dixonvalve.com.



Only use the crimp style shanks with the crimp style sleeves and ferrules.

Due to differences in dimensions and tolerances for safety reasons, do not interchange other manufacturer's products with Dixon® products.



King Crimp™ Style 150# ASA Fixed (Welded) Flanges



Only use the crimp style shanks with the crimp style sleeves and ferrules.

Due to differences in dimensions and tolerances for safety reasons, do not interchange other manufacturer's products with Dixon® products.

Features:

- There are two grooves on the crimp style King™ Combination nipples. The second groove is the roll stamp groove which has the part number and 'call Dixon®' stamped on it. This groove is a smooth concentric groove so that the stamp is legible.



Size	Steel		316 Stainless Steel	
	Part #	Price/E	Part #	Price/E
1½"	FST20CS	\$98.00	RFST20CS	\$288.00
2"	FST25CS	104.90	RFST25CS	310.00
3"	FST35CS	156.25	RFST35CS	480.00
4"	FST40CS	182.20	RFST40CS	688.50
6"	FST60CS	316.00	RFST60CS	1165.00

- For flange dimensions, diagrams and additional information please reference dixonvalve.com.
- For additional information on pipe dimensions please reference dixonvalve.com.

King Crimp™ Style Combination Nipple x TTMA Flanges



carbon steel



aluminum

Feature:

- to be used with King Crimp™ sleeves and/or ferrules

Size	Flange Thickness	Carbon Steel		Aluminum	
		Part #	Price/E	Part #	Price/E
3"	¼"	TTFST35CS	\$183.00	---	---
3"	⅜"	TTFST35CS-THK	190.90	---	---
4"	5/16"	TTFST40CS	222.50	ATTFST40CS	\$212.70
4"	⅜"	TTFST40CS-THK	227.25	---	---

- For flange dimensions, diagrams and additional information please reference dixonvalve.com.
- For additional information on pipe dimensions please reference dixonvalve.com.

King Crimp™ Style Nipple for Floating Flanges



Feature:

- to be used with King Crimp™ sleeves and/or ferrules

Size	Plated Carbon Steel		316 Stainless Steel	
	Part #	Price/E	Part #	Price/E
2"	N25CS	\$134.85	RN25CS	\$225.00
3"	N35CS	189.35	RN35CS	354.50
4"	N40CS	244.20	RN40CS	457.60
6"	N60CS	496.55	RN60CS	1115.00

King Crimp™ Style Short Combination Nipples

Threaded End

- for use with ferrules below

Size	Schedule 40 Plated Carbon Steel	
	Part #	Price/E
8"	STC80CS	\$170.10



Grooved End

Size	Schedule 40 Plated Carbon Steel	
	Part #	Price/E
8"	STV80CS	\$158.00



- For additional information on pipe dimensions please reference dixonvalve.com.

King Crimp™ Style Short Ferrules

Features:

- schedule 40 plated carbon steel to ASTM standards
- consult Dixon® for additional ferrule sizes

Hose ID	Hose OD		Ferrule Wall Thickness	Ferrule ID	Ferrule Overall Length	Carbon Steel	
	From	To				Part #	Price
8"	8-29/64"	8-36/64"	.120"	8.625"	4.25"	CFS800-1CS	\$133.00
	8-37/64"	8-44/64"	.120"	8.750"	4.25"	CFS800-2CS	133.00
	8-45/64"	8-52/64"	.120"	8.875"	4.25"	CFS800-3CS	133.00
	8-53/64"	8-60/64"	.120"	9.000"	4.25"	CFS800-4CS	133.00
	8-61/64"	9-4/64"	.120"	9.125"	4.25"	CFS800-5CS	133.00
	9-5/64"	9-12/64"	.120"	9.250"	4.25"	CFS800-6CS	133.00
	9-13/64"	9-20/64"	.120"	9.375"	4.25"	CFS800-7CS	133.00
	9-21/64"	9-28/64"	.120"	9.500"	4.25"	CFS800-8CS	133.00



King Crimp™ Style Large Sleeves

Hose ID	Sleeve ID	Sleeve Wall Thickness	Sleeve Overall Length	Carbon Steel	
				Part #	Price
8"	8.30"	0.120"	8.75"	S830X875X120CS	\$66.65
	8.38"	0.120"	6.00"	S838X600X120CS	66.65
	8.50"	0.120"	6.50"	S850X650X120CS	66.65
	8.75"	0.120"	6.00"	S875X600X120CS	66.65
	8.98"	0.120"	8.75"	S898X875X120CS	66.65
	9.00"	0.090"	4.00"	S900X400X090CS	66.65
	9.00"	0.120"	4.00"	S900X400X120CS	66.65
	9.00"	0.120"	6.00"	S900X600X120CS	66.65
	9.10"	0.120"	4.00"	S910X400X120CS	66.65
	9.12"	0.120"	6.00"	S912X600X120CS	66.65
	9.15"	0.120"	6.00"	S915X600X120CS	66.65
	9.25"	0.120"	4.00"	S925X400X120CS	66.65
	9.25"	0.120"	6.00"	S925X600X120CS	66.65
	9.50"	0.120"	4.00"	S950X400X120CS	66.65
	9.50"	0.120"	6.00"	S950X600X120CS	66.65
	9.75"	0.120"	6.00"	S975X600X120CS	66.65
10"	10.25"	0.120"	7.50"	S1025X750X120CS	90.90
	10.50"	0.120"	7.50"	S1050X750X120CS	90.90
	11.00"	0.120"	6.00"	S1100X600X120CS	90.90
	11.75"	0.120"	6.00"	S1175X600X120CS	90.90



- consult Dixon® for additional sleeve sizes

Heavy Duty King Crimp™ Style Combination Nipples - Threaded End



Application:

- used in the fast paced transfer of water, chemicals and sand slurry to a hydraulic fracturing site

Features:

- Water and petroleum transfer hoses rated from 100 to 300 PSI WP (4:1 SF) have excellent test results with the standard King Crimp™ ferrules *CF400-xxCS*.
- 400 PSI working pressure at 70°F (21°C) when used with heavy duty crimp ferrules (CF400-6CSHD through CF400-16CSHD)
- used with ferrules on page C-51

Size	Description	Schedule 80 Steel	
		Part#	Price/E
4"	male NPT fitting	STC40CSHD	\$74.00



King Crimp™ Style Ferrules - Heavy Duty



Only use the crimp style shanks with the crimp style sleeves and ferrules. Due to differences in dimensions and tolerances for safety reasons, do not interchange other manufacturer's products with Dixon® products.

- 400 PSI working pressure with a minimum 4:1 safety factor (*hose burst: hose working pressure*) is only achieved with heavy duty (HD) crimp ferrules, CF400-6CSHD through CF400-16CSHD.

Hose ID	Hose OD		Ferrule Wall Thickness	Ferrule ID	Ferrule Overall Length	Carbon Steel	
	From	To				Part #	Price
4"	4-33/64"	4-36/64"	0.120"	4.625"	4"	CF400-6CSHD	\$36.30
	4-37/64"	4-40/64"	0.120"	4.688"	4"	CF400-7CSHD	36.30
	4-41/64"	4-44/64"	0.120"	4.750"	4"	CF400-8CSHD	36.30
	4-45/64"	4-48/64"	0.120"	4.813"	4"	CF400-9CSHD	36.30
	4-49/64"	4-52/64"	0.120"	4.875"	4"	CF400-10CSHD	36.30
	4-53/64"	4-56/64"	0.120"	4.938"	4"	CF400-11CSHD	36.30
	4-57/64"	4-60/64"	0.120"	5.000"	4"	CF400-12CSHD	36.30
	4-61/64"	5"	0.120"	5.063"	4"	CF400-13CSHD	36.30
	5-1/64"	5-4/64"	0.120"	5.125"	4"	CF400-14CSHD	36.30
	5-5/64"	5-8/64"	0.120"	5.188"	4"	CF400-15CSHD	36.30
	5-9/64"	5-12/64"	0.120"	5.250"	4"	CF400-16CSHD	36.30



King Crimp™ System	D-4	Type F Adapters.....	D-25
Working pressures.....	D-4	Boss-Lock™	D-25
Cam & Groove		Dust Caps and Plugs.....	D-26 to D-29
EZLink™ Armless.....	D-7 to D-8	Dixon® caps	D-26
Type B	D-7	Dixon® Lockable caps.....	D-27
Type C	D-7	Boss-Lock™ caps.....	D-27
Type D	D-7	EZ Boss-Lock™ caps	D-28
Type DC.....	D-8	Boss-Lock™ plugs.....	D-29
Replacement parts	D-8		
Safety clip	D-8	Hastelloy®	D-30 to D-31
Bottle opener	D-8	Type A.....	D-30
		Type E	D-30
Vent-Lock™ Safety.....	D-9 to D-11	Type F.....	D-30
Type A.....	D-9	EZ Boss-Lock™ Type B	D-31
Type C	D-9	EZ Boss-Lock™ Type C	D-31
Type D	D-10	EZ Boss-Lock™ Type D	D-31
Type E	D-10		
Dust caps and plugs	D-10	Reducing Couplers, Adapters and	Spools.....
Accessories	D-11		D-32 to D-36
Type A Adapters	D-12	Dixon® with port	D-32
Dixon® / Boss-Lock™	D-12	Dixon®	D-32
		Boss-Lock™	D-33
Type B Couplers.....	D-13 to D-14	EZ Boss-Lock™.....	D-33
Dixon®.....	D-13	Reducing Dixon® with port.....	D-33
Boss-Lock™	D-14	Dixon® Spool.....	D-34
EZ Boss-Lock™.....	D-14	Boss-Lock™ spool.....	D-34
		Reducing Type A.....	D-35
Type C Couplers.....	D-15 to D-19	Reducing Type B	D-35
Dixon®.....	D-15	Reducing Type C	D-35
Dixon® notched NOS	D-16	Reducing Type D	D-36
Boss-Lock™	D-16	Reducing Type E	D-36
Boss-Lock™ with collar	D-17	Reducing Type F	D-36
Boss-Lock™ notched	D-17		
EZ Boss-Lock™.....	D-18	Elbows.....	D-37 to D-39
EZ Boss-Lock™ phono finish	D-18	45°	D-37
EZ Boss-Lock™ swaged with ferrule.....	D-19	90°	D-37, D-38 to D-39
EZ Boss-Lock™ notched.....	D-19		
Type D Couplers.....	D-20 to D-22	Flanged	D-40
Dixon®.....	D-20	Dixon®.....	D-40
Boss-Lock™	D-21	EZ Boss-Lock™	D-40, D-41
EZ Boss-Lock™	D-22		
Type E Adapters	D-23 to D-24	Weld End	D-41 to D-42
Boss-Lock™	D-23	Dixon® couplers	D-41
Boss-Lock™ phono finish.....	D-24	EZ Boss-Lock™ couplers	D-41, D-42
Boss-Lock™ swaged with ferrule	D-24	Adapters	D-42
Boss-Lock™ notched	D-24		
		Boss-Lock Coupler x Tube.....	D-43
		In-Line Sight Glasses	D-43

NSPM and Wye D-44

Accessories D-45 to D-53

Handles	D-45 to D-46
Gaskets	D-47 to D-50
Strainers	D-51
Pull rings.....	D-51
Clips.....	D-52
Jack chain with S-hook.....	D-52
Velcro® straps	D-52
Lanyards.....	D-53

Global D-54 to D-62

Type A.....	D-54
Type B	D-55
Type C	D-56
Type D	D-57
Type E	D-58
Type F.....	D-58
Dust caps and plugs	D-59
Jump size	D-60 to D-61
Type DA	D-60
Type AA.....	D-60
Type DD	D-60
TTMA flange.....	D-60
Type A.....	D-61
Type C.....	D-61
Type E.....	D-61
Accessories	D-62

Swivel Adapters..... D-63

Type A.....	D-63
Type B	D-63
Type D	D-63
Type F.....	D-63

Polypropylene D-64 to D-68

Type A.....	D-64
90° adapter x female NPT	D-64
Type B	D-64
Type C	D-65
90° coupler x hose shank.....	D-65
Type D	D-66
90° coupler x female NPT.....	D-66
Type E	D-67
Type F.....	D-67
90° adapter x male NPT	D-67
Dust caps and plugs	D-68



EZLink™ Armless

**Features:**

- automatic couplers push-to-connect providing a reliable connection
- coupler tabs cannot be pushed to disconnect when pressurized to 20 PSI or over
- low profile allows easy connection and disconnection in tight applications
- coupler push tabs can be locked with safety pins and/or zip tie
- maximum working pressure with King Crimp™ ferrules: **250 PSI** (2"), **150 PSI** (3" and 4")
- 4" maximum working pressure with crimp sleeves: **110 PSI**
- 4" maximum working pressure with band clamps: **100 PSI**
- gasket temperature range: **5°F to 180°F (-15°C to 82°C)**

Vent-Lock™ Safety

**Features:**

- safety release cam & groove couplings permit the release of static pressure when disconnecting hose assemblies
- venting system protects operator from being sprayed with hazardous or non-hazardous fluids or solids
- rated to **250 PSI**, recommendation based on the use of mating Dixon™ L-style fittings at ambient temperature **70°F (21°C)** with standard Buna-N seal installed, for use at elevated temperature or other unusual operating conditions, consult Dixon™
 - 1", 1½" and 2" sizes have a maximum working pressure of **250 PSI**
 - 3" maximum working pressure **150 PSI** with King Crimp™ ferrules, crimp sleeves and bands at **125 PSI**
- does not interchange with standard cam & groove products use only with Vent-Lock™ 

Dixon®

**Features:**

- precision machined to rigid tolerances
- durable stainless steel cam arm pins will not rust or bind, providing greater strength and safety
- recess holds gasket firmly in place - ensures proper placement
- long shank design allows proper banding, thus eliminating the major cause of hose damage

EZ Boss-Lock™

Features:

- no more fumbling with clamps, wire, clips or pins, just close the handles and the locking mechanism is engaged
- extremely easy to open, the release lever is under your thumb when you want to open the fitting, ergonomic
- resistant to accidental disconnection when being dragged; the release lever opens in the direction opposite to the cam arm, so movements that can open the release lever also can close the cam arm
- if the rotating lever is not flush with the handle, it is not properly engaged
- no sliding pins to jam or pop open
- rotating action helps keep the locking device free of debris
- rugged design protects critical parts from impact
- can be supplied with custom shanks, also available with swaged and PF shanks for hard to couple chemical hoses
- assemblies are investment cast stainless steel with plated carbon steel pull rings
- small OD makes it easy to insert into the hose tubes on tank trucks and to use in restricted spaces
- assemblies can be retrofitted onto undamaged stainless steel Boss-Lock™ allowing you to protect your investment in stainless steel Boss-Lock™ couplings while you upgrade
- EZ Boss-Lock™ investment stainless steel cam arms are guaranteed! Should you break one, return it to the nearest warehouse for a free replacement.



Boss-Lock™

Features:

- The cast-in lugs allow safety clips to be attached once the lugs are passed through slots in the special cam lever arms providing a patented safety feature. The clips prevent the coupler from being unlocked until they are removed, providing a *positive locking action*.
- Boss-Lock™ investment stainless steel cam arms are guaranteed! Should you break a Boss-Lock™ investment stainless steel cam arm, return it to the nearest warehouse for a free replacement.
- The pull ring safety clip simplifies the locking action on Boss-Lock™ couplers. No more inserting clips or dangling lanyards, just a twist and it's locked, giving you a low profile positive locking action.



King Crimp™ System Cam and Groove



Dixon® Type C domestic coupler



EZ Boss-Lock™ Type C domestic coupler



Type C global coupler



Dixon® Type E domestic adapter



Type E global adapter

- for a complete listing of King Crimp™ system products, including cam & groove fittings, please reference pages C-38 to C-51

Crimp Working Pressure Chart

Size	Temperature	Fitting	Clamp	Dixon® Crimp (PSI)	Size	Temperature	Fitting	Clamp	Dixon® Crimp (PSI)
1"	Ambient	100-C/E	sleeve	250	3"	Ambient	300-C/E	sleeve	125
	160°F (71°C)	100-C/E	sleeve	242		160°F (71°C)	300-C/E	sleeve	100
	180°F (82°C)	100-C/E	sleeve	240		180°F (82°C)	300-C/E	sleeve	60
	250°F (121°C)	100-C/E	sleeve	200		250°F (121°C)	300-C/E	sleeve	55
	Ambient	100-C/E	ferrule	250		Ambient	300-C/E	ferrule	150
	160°F (71°C)	100-C/E	ferrule	242		160°F (71°C)	300-C/E	ferrule	125
	180°F (82°C)	100-C/E	ferrule	240		180°F (82°C)	300-C/E	ferrule	100
	250°F (121°C)	100-C/E	ferrule	200		250°F (121°C)	300-C/E	ferrule	75
1½"	Ambient	150-C/E	sleeve	250	4"	Ambient	400-C/E	sleeve	110
	160°F (71°C)	150-C/E	sleeve	200		160°F (71°C)	400-C/E	sleeve	75
	180°F (82°C)	150-C/E	sleeve	100		180°F (82°C)	400-C/E	sleeve	60
	250°F (121°C)	150-C/E	sleeve	75		250°F (121°C)	400-C/E	sleeve	50
	Ambient	150-C/E	ferrule	250		Ambient	400-C/E	ferrule	150
	160°F (71°C)	150-C/E	ferrule	200		160°F (71°C)	400-C/E	ferrule	75
	180°F (82°C)	150-C/E	ferrule	150		180°F (82°C)	400-C/E	ferrule	75
	250°F (121°C)	150-C/E	ferrule	100		250°F (121°C)	400-C/E	ferrule	75
2"	Ambient	200-C/E	sleeve	250	6"	Ambient	600-C/E	sleeve	75
	160°F (71°C)	200-C/E	sleeve	100		160°F (71°C)	600-C/E	sleeve	*
	180°F (82°C)	200-C/E	sleeve	50		180°F (82°C)	600-C/E	sleeve	*
	250°F (121°C)	200-C/E	sleeve	50		250°F (121°C)	600-C/E	sleeve	*
	Ambient	200-C/E	ferrule	250		Ambient	600-C/E	ferrule	75
	160°F (71°C)	200-C/E	ferrule	100		160°F (71°C)	600-C/E	ferrule	*
	180°F (82°C)	200-C/E	ferrule	100		180°F (82°C)	600-C/E	ferrule	*
	250°F (121°C)	200-C/E	ferrule	100		250°F (121°C)	600-C/E	ferrule	*

* Consult Dixon® for PSI ratings

Ordering System

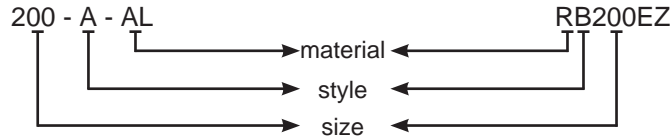

Size represents the coupler or adapter and hose or pipe end (i.e. 200 = 2"). If the coupling is a reducing size, the coupler or adapter is the first size (i.e. 4030-C is 4" coupler to 3" hose shank).

Operation of Cam and Groove

1. To make connection, slide the adapter into the coupler and with normal hand pressure, press the cam levers down.
2. Uncoupling is as quick and simple as coupling. Just lift the cam arms and remove the adapter.

Specifications on Dixon Cam and Groove

Specifications:

- Dixon®, Boss-Lock™ and EZ Boss-Lock™ cam & groove couplers and adapters are produced to interchange with all product produced to Commercial Item Description A-A-59326D.
- No standard exists for the ½" and 8" fittings, and generally these sizes do not interchange with other manufacturers.
- Dust caps and dust plugs are **not** to be used in pressure applications for safety and environmental reasons.
- *Designed for use with liquids*, consult Dixon® for specific recommendations.



Pressure Ratings:

Recommendations based on the use of mating Dixon® fittings at ambient temperature **70°F (21°C)** with standard Buna-N seal installed. For use at elevated temperature or other unusual operating conditions, consult Dixon®. Dixon®, Boss-Lock™ and EZ Boss-Lock™ couplers and adapters maximum working pressure are as follows:



Size	½"	¾" thru 2"	2½"	3"	4"	5" and 6"	8"
PSI	150	250	150	125	100	75	50
PSI (working pressure with King Crimp™ ferrule system)	150	250	150	150	150	75	50

Cam and Groove Nominal Take-Up Lengths

Coupling Size	Dimension A
½"	0.97"
¾"	0.97"
1"	1.20"
1¼"	1.44"
1½"	1.50"
2"	1.81"
2½"	1.82"
3"	1.78"
4"	1.84"
5"	2.00"
6"	2.13"
8"	2.06"
8"	3.22"

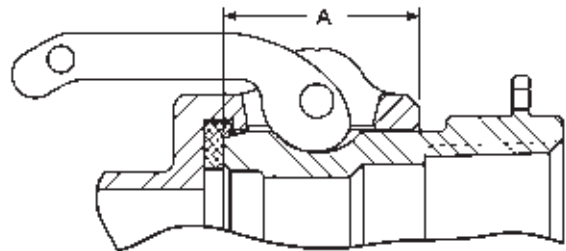

Cam and Groove Configurations

Configurations are representative of the Dixon® line of cam & groove.

Cam & Groove



Type A
female NPT x male adapter



Type E
male adapter x hose shank

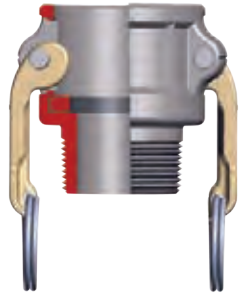

Type B
female coupler x male NPT



Type F
male NPT x male adapter

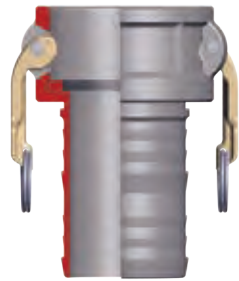

Type C
female coupler x hose shank

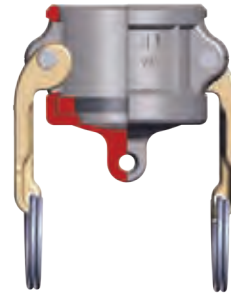

Type DC¹
dust cap

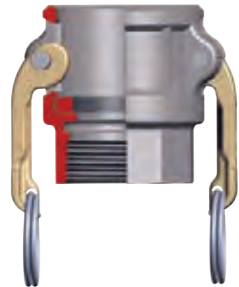

Type D
female coupler x female NPT



Type DP¹
dust plug



¹ Dust caps and dust plugs are not to be used in pressure applications for safety and environmental reasons.

⚠ WARNING

Under no circumstances should cam and groove couplings be used for compressed air or steam service!

EZLink™ Armless Cam and Groove

NEW

Cam & Groove

Applications:

- transfer and/or unloading of fuels (gasoline or diesel) from tank truck to storage tanks
- transfer of liquids compatible with the available coupling and gasket materials

Materials:

- Couplings and dust caps: A356 aluminum, 316 stainless steel
- Coupler tabs and springs: 316 stainless steel
- Gasket: Buna-N

Features:

- automatic couplers push-to-connect providing a reliable connection
- low profile allows easy connection and disconnection in tight applications
- coupler push tabs can be locked with safety pins and/or zip tie
- compatible with standard cam and groove adapters

Specifications:

- maximum working pressure with King Crimp™ ferrules: **250 PSI** (2"), **150 PSI** (3" and 4")
- 4" maximum working pressure with crimp sleeves: **110 PSI**
- 4" maximum working pressure with band clamps: **100 PSI**
- gasket temperature range: **5°F to 180°F (-15°C to 82°C)**

Only use EZLink™ gaskets for this coupling system. Traditional cam & groove gaskets, or other types of seals are not compatible and will fail. 



Type B Coupler x Male NPT

Size	A356 Aluminum		316 Stainless Steel	
	Part #	Price/E	Part #	Price/E
2"	EZL200-B-AL	\$44.90	EZL200-B-SS	\$131.60
3"	EZL300-B-AL	60.20	---	---
4"	EZL400-B-AL	88.85	---	---



Type C Coupler x King Crimp™ Hose Shank

Size	A356 Aluminum		316 Stainless Steel	
	Part #	Price/E	Part #	Price/E
2"	EZL200-C-AL	\$43.65	EZL200-C-SS	\$125.70
3"	EZL300-C-AL	63.80	---	---
4"	EZL400-C-AL	84.85	---	---



Type D Coupler x Female NPT

Size	A356 Aluminum		316 Stainless Steel	
	Part #	Price/E	Part #	Price/E
2"	EZL200-D-AL	\$46.80	EZL200-D-SS	\$129.50
3"	EZL300-D-AL	56.45	---	---
4"	EZL400-D-AL	85.70	---	---



NEW



Type DC Dust Caps

Size	A356 Aluminum		316 Stainless Steel	
	Part #	Price/E	Part #	Price/E
2"	EZL200-DC-AL	\$40.75	EZL200-DC-SS	\$115.50
3"	EZL300-DC-AL	47.25	---	---
4"	EZL400-DC-AL	59.40	---	---

Replacement Kits



Feature:

- kit contains: 2 pins, 2 springs and 2 tabs

Size	A356 Aluminum	
	Part #	Price/E
2"	EZL200RPLKIT	\$15.00
3" and 4"	EZL300RPLKIT	18.00

Replacement Gaskets



Size	Buna-N	
	Part #	Price/E
2"	EZL200-G-BU	\$6.10
3"	EZL300-G-BU	7.60
4"	EZL400-G-BU	9.25

Safety Clip



Plated Carbon Steel	
Part #	Price/E
EZLCL400	\$1.25

- clip is optional

Bottle Opener



Brass	
Part #	Price/E
CAMOPENER	\$4.50

Vent-Lock™ Safety Cam and Groove Couplings

Application:

- transfer of fluids and solids, with a safer disconnection

Features:

- safety release cam and groove couplings permit the release of static pressure when disconnecting hose assemblies
- venting system protects operator from being sprayed with hazardous or non-hazardous fluids or solids
- rated to **250 PSI**, recommendation based on the use of mating Dixon™ L-style fittings at ambient temperature **70°F (21°C)** with standard Buna-N seal installed, for use at elevated temperature or other unusual operating conditions, consult Dixon™
 - 1", 1½" and 2" sizes have a maximum working pressure of **250 PSI**
 - 3" maximum working pressure **150 PSI** with King Crimp™ ferrules, crimp sleeves and bands at **125 PSI**
- does not interchange with standard cam and groove products use only with Dixon™ L-style fittings 
- safety orange cam arms
- consult Dixon™ for availability of other materials

Attachment Options:

- ferrules, sleeves, bands, and other reliable options

Type A Adapter x Female NPT

Size	316 Stainless Steel	
	Part #	Price/E
1"	L100-A-SS	\$54.35
1½"	L150-A-SS	56.10
2"	L200-A-SS	69.30
3"	L300-A-SS	132.00



Type C Coupler x Hose Shank

Size	316 Stainless Steel	
	Part #	Price/E
1"	L100-C-SS	\$87.25
1½"	L150-C-SS	130.00
2"	L200-C-SS	125.70



EZ Boss-Lock™ Type C Coupler x Hose Shank

Size	type C 316 Stainless Steel	
	Part #	Price/E
1"	RLC100EZ	\$119.65
1½"	RLC150EZ	126.50
2"	RLC200EZ¹	157.80
3"	RLC300EZ¹	240.95



¹ has drop shank

Type D Coupler x Female NPT

Cam & Groove



Size	316 Stainless Steel	
	Part #	Price/E
1"	RLD100EZ	\$124.50
1½"	RLD150EZ	153.25
2"	RLD200EZ	158.75

Type E Adapter x Hose Shank



Size	316 Stainless Steel	
	Part #	Price/E
1"	L100-E-SS	\$56.10
1½"	L150-E-SS	79.60
2"	L200-E-SS	84.00
3"	L300-E-SS	156.25

Dust Caps & Plugs

Type DC Dust Caps



Size	316 Stainless Steel	
	Part #	Price/E
1"	L100-DC-SS	\$78.65
1½"	L150-DC-SS	97.90
2"	L200-DC-SS	115.50

Type DP Dust Plugs



Size	316 Stainless Steel	
	Part #	Price/E
1"	L100-DP-SS	\$48.95
1½"	L150-DP-SS	66.55
2"	L200-DP-SS	70.40
3"	L300-DP-SS	113.00

Type H Dust Caps



Size	316 Stainless Steel	
	Part #	Price/E
1"	RLH100EZ	\$105.40
1½"	RLH150EZ	138.95
2"	RLH200EZ	154.95
3"	RLH300EZ	233.80

Accessories

Dixon® handle / ring / pin

Feature:

- use only with Dixon® Vent-Lock™ couplers 

Size	316 Stainless Steel	
	Part #	Price/E
1"	L100-HSCRP-SI	\$18.00
1½" - 2"	L200-HSCRP-SI	18.25



EZ Boss-Lock™ handle / ring / pin

Feature:

- use only with EZ Boss-Lock™ Vent Lock™ couplers 

Size	316 Stainless Steel	
	Part #	Price/E
1"	LRHEZ175	\$20.00
1½" - 2"	LRHEZ152	21.50
3"	LRHEZ34	24.00



Dixon / Boss-Lock™ Type A Adapter x Female NPT

Cam & Groove



356T6 aluminum



aluminum hardcoat



brass



unplated malleable iron



plated malleable iron



316 stainless steel

Feature:

- Pressure rating is based on the seal of the mating part. See ratings on page D-5

Size	356T6 Aluminum		Aluminum Hard Coat		Brass	
	Part #	Price/E	Part #	Price/E	Part #	Price/E
1/2"	50-A-AL ²	\$12.40	---	---	50-A-BR	\$19.00
3/4" x 1/2"	7550-A-AL ²	15.25	---	---	7550-A-BR	36.70
3/4"	75-A-AL ²	10.20	---	---	75-A-BR	23.10
1"	100-A-AL ²	12.85	---	---	100-A-BR	26.90
1 1/4"	125-A-AL	17.20	---	---	125-A-BR	43.00
1 1/2"	150-A-AL	17.60	150-A-ALH	\$30.30	150-A-BR	43.95
2"	200-A-AL	19.30	200-A-ALH	36.00	200-A-BR	55.60
2 1/2"	250-A-AL	28.90	---	---	250-A-BR	98.50
3"	300-A-AL	27.95	300-A-ALH	47.00	300-A-BR	112.25
4"	400-A-AL	62.80	400-A-ALH	97.00	400-A-BR	190.00
5"	500-A-AL	102.00	---	---	500-A-BR	298.90
6"	600-A-AL	122.80	600-A-ALH	188.00	600-A-BR	397.00
8" DIX	800-A-AL ¹	341.25	---	---	---	---
8" BL	801-A-AL ¹	357.95	---	---	---	---

¹ Dixon® and Boss-Lock™ cam & groove couplings do not interchange in the 1/2" and 8" sizes.



² made from 6061-T6 aluminum

Size	Unplated Malleable Iron		Plated Malleable Iron		316 Stainless Steel	
	Part #	Price/E	Part #	Price/E	Part #	Price/E
1/2"	---	---	---	---	50-A-SS	\$45.45
3/4" x 1/2"	---	---	---	---	7550-A-SS	67.70
3/4"	---	---	75-A-PM	\$16.95	75-A-SS	46.75
1"	---	---	100-A-PM	19.00	100-A-SS	49.40
1 1/4"	---	---	---	---	125-A-SS	61.30
1 1/2"	150-A-MI	\$26.00	150-A-PM	29.00	150-A-SS	59.40
2"	200-A-MI	32.10	200-A-PM	36.00	200-A-SS	63.00
2 1/2"	---	---	---	---	250-A-SS	198.75
3"	300-A-MI	50.80	300-A-PM	55.50	300-A-SS	120.00
4"	400-A-MI	82.00	400-A-PM	86.60	400-A-SS	222.00
5"	500-A-MI	173.25	---	---	500-A-SS	346.00
6"	---	---	600-A-PM ¹	190.00	600-A-SS	384.80

¹ ductile iron

Dixon® Type B Coupler x Male NPT

Features:

- Finger rings are not supplied on ½" - 1" Dixon® couplings.
- ½" Dixon® coupler has only one cam arm.
- Couplers are supplied standard with a Buna-N gasket. Other gasket types are available on pages D-48 to D-50.

Size	356T6 Aluminum		Aluminum Hard Coat		Brass	
	Part #	Price/E	Part #	Price/E	Part #	Price/E
½"	50-B-AL	\$25.60	---	---	50-B-BR	\$40.50
¾"	75-B-AL	25.75	---	---	75-B-BR	46.10
1"	100-B-AL	26.90	---	---	100-B-BR	51.00
1¼"	125-B-AL	44.70	---	---	---	---
1½"	150-B-AL	28.70	150-B-ALH	\$47.50	150-B-BR	76.25
2"	200-B-AL	35.10	200-B-ALH	54.00	200-B-BR	87.00
2½"	250-B-AL	66.00	---	---	---	---
3"	300-B-AL	56.25	300-B-ALH	81.30	300-B-BR	167.40
4"	400-B-AL	80.80	400-B-ALH	122.00	400-B-BR	228.00
5"	500-B-AL	140.90	---	---	---	---
6"	600-B-AL	186.80	600-B-ALH	267.00	---	---
8"	800-B-AL ^{1,2}	1030.00	---	---	---	---

¹ Dixon® and Boss-Lock™ cam & groove couplings *do not interchange in the ½" and 8" sizes.* The 8" Dixon® design has 4 cam arms, Boss-Lock™ design has 2 cam arms.

² Parts are produced as a welded fabrication.



356T6 aluminum



aluminum hard coat



brass



unplated malleable iron



316 stainless steel

Size	Unplated Malleable Iron		316 Stainless Steel	
	Part #	Price/E	Part #	Price/E
½"	---	---	50-B-SS	\$74.80
¾"	---	---	75-B-SS	73.40
1"	---	---	100-B-SS	81.00
1½"	150-B-MI ¹	\$57.95	150-B-SS	105.80
2"	200-B-MI	70.50	200-B-SS	119.60
2½"	---	---	250-B-SS	284.00
3"	300-B-MI ¹	105.00	300-B-SS	225.00
4"	400-B-MI	154.05	400-B-SS	275.00
6"	---	---	600-B-SS	782.00

¹ ductile iron

Boss-Lock™ Type B Coupler x Male NPT

Cam & Groove



356T6 aluminum



brass



plated malleable iron



316 stainless steel

Features:

- All Boss-Lock™ couplers are supplied with pull-ring safety clips.
- Couplers are supplied standard with a Buna-N gasket. Other gasket types are available on pages D-48 to D-50.

Size	356T6 Aluminum		Brass	
	Part #	Price/E	Part #	Price/E
¾"	---	---	BB075	\$69.00
1"	AB100	\$45.25	BB100	73.60
1¼"	AB125	49.35	BB125	88.30
1½"	AB150	44.40	BB150	96.30
2"	AB200	45.40	BB200	116.85
2½"	AB250	68.15	BB250	146.50
3"	AB300	75.25	BB300	205.00
4"	AB400	105.00	BB400	295.00
6"	AB600	283.65	---	---

Size	Plated Malleable Iron		316 Stainless Steel	
	Part #	Price/E	Part #	Price/E
¾" x ½"	---	---	RB050BL	\$98.25
¾"	---	---	RB075BL	91.30
1"	IB100	\$60.00	RB100BL	93.75
1¼"	---	---	RB125BL	133.35
1½"	---	---	RB150BL	128.00
2"	IB200	81.25	RB200BL	136.25
3"	---	---	RB300BL	256.00
4"	---	---	RB400BL	296.00

EZ Boss-Lock™ Type B Coupler x Male NPT



356T6 aluminum



brass



316 stainless steel

Features:

- Couplers are supplied standard with a Buna-N gasket. Other gasket types are available on pages D-48 to D-50.
- *Under no circumstances should the EZ Boss-Lock™ cam arms be used on any fitting not specifically designed for their use.* See pages D-3 and D-46 for further specifications. 

Size	356T6 Aluminum		Brass		316 Stainless Steel	
	Part #	Price/E	Part #	Price/E	Part #	Price/E
¾" x ½"	---	---	---	---	RB050EZ	\$119.00
¾"	---	---	BB075EZ	\$94.00	RB075EZ	104.00
1"	AB100EZ	\$69.20	BB100EZ	116.00	RB100EZ	109.70
1¼"	---	---	BB125EZ	126.00	RB125EZ	146.40
1½"	AB150EZ	79.75	BB150EZ	138.00	RB150EZ	143.65
2"	AB200EZ	81.30	BB200EZ	156.80	RB200EZ	157.00
3"	AB300EZ	120.75	BB300EZ	275.60	RB300EZ	272.95
4"	AB400EZ	152.50	BB400EZ	370.80	RB400EZ	325.00
6"	---	---	---	---	RB600EZ	595.30

Dixon® Type C Coupler x Hose Shank

Features:

- Finger rings are not supplied on 1" Dixon® couplings.
- Couplers are supplied standard with a Buna-N gasket. Other gasket types are available on pages D-48 to D-50
- ½" Dixon coupler has only one cam arm.

Hose ID	356T6 Aluminum		Aluminum Hard Coat		Brass	
	Part #	Price/E	Part #	Price/E	Part #	Price/E
½"	50-C-AL	\$21.50	---	---	50-C-BR	\$46.40
¾"	75-C-AL	24.70	---	---	75-C-BR	50.95
1"	100-C-AL	28.70	---	---	100-C-BR	62.05
1¼"	125-C-AL	57.00	---	---	125-C-BR	88.00
1½"	150-C-AL	36.50	150-C-ALH	\$46.00	150-C-BR	83.60
2"	200-C-AL	37.95	200-C-ALH	57.30	200-C-BR	109.05
2½"	250-C-AL	69.65	---	---	250-C-BR	136.00
3"	300-C-AL	60.00	300-C-ALH	87.95	300-C-BR	189.00
4"	400-C-AL	81.60	400-C-ALH	111.40	400-C-BR	238.00
5"	500-C-AL	123.85	---	---	---	---
6"	600-C-AL	195.95	600-C-ALH	251.00	600-C-BR	814.90
8"	800-C-AL ¹	757.00	---	---	---	---



356T6 aluminum



aluminum hard coat



brass



unplated ductile iron



316 stainless steel

Hose ID	Unplated Ductile Iron		316 Stainless Steel	
	Part #	Price/E	Part #	Price/E
½"	---	---	50-C-SS	\$57.60
¾"	---	---	75-C-SS	69.10
1"	---	---	100-C-SS	79.30
1¼"	---	---	125-C-SS	142.55
1½"	150-C-MI	\$51.55	150-C-SS	96.60
2"	200-C-MI	54.00	200-C-SS	114.25
2½"	---	---	250-C-SS	292.50
3"	300-C-MI ^{2,3}	87.00	300-C-SS	198.70
4"	400-C-MI ^{2,3}	112.20	400-C-SS	336.00
5"	---	---	500-C-SS	474.00
6"	600-C-MI ^{2,3}	210.00	600-C-SS	548.00

¹ Dixon® and Boss-Lock™ cam & groove couplings *do not interchange in the ½" and 8" sizes.* The 8" Dixon® design has 4 cam arms, Boss-Lock™ design has 2 cam arms.

² Suitable for use with King Crimp™ sleeves and ferrules, see pages C-42 to C-45

³ ductile iron

Only use the crimp style shanks with the crimp style sleeves and ferrules.

Due to differences in dimensions and tolerances for safety reasons, do not interchange other manufacturer's products with Dixon® products.



Dixon® Notched NOS Type C Coupler x NOS shank

Cam & Groove



Features:

- system allows you to better manage your inventories, you can stock one stem and two ferrules, and cover the same hose range with less inventory, *you must purchase a fitting and the matching ferrule to create an assembly*
- for hose outside diameters of 2-4/64" and below, *the couplings are crimp only* 
- for hose outside diameters of 2-5/64" and above, the couplings can be crimped or swaged
- for use with notched ferrules on page F-22
- see page E-6 for male NPT notched NOS fittings

Size	316 Stainless Steel	
	Part #	Price/E
1½"	150CNOSSS ¹	\$83.25
2"	200CNOSSS	85.10
3"	300CNOSSS	168.90

¹ part will be discontinued as stock is depleted

Only use the NOS shank with the NOS ferrules.

Due to differences in dimensions and tolerances for safety reasons, do not use other manufacturer's stems or ferrules with Dixon® products. 

Boss-Lock™ Type C Coupler x Hose Shank

Features:

- All Boss-Lock™ couplers are supplied with pull-ring safety clips.
- Couplers are supplied standard with a Buna-N gasket. Other gasket types are available on pages D-48 to D-50



356T6 aluminum



brass



plated malleable iron



316 stainless steel

Size	356T6 Aluminum		Brass	
	Part #	Price/E	Part #	Price/E
¾"	AC075	\$36.00	BC075	\$57.00
1"	AC100	37.30	BC100	70.00
1¼"	AC125	46.25	BC125	95.50
1½"	AC150	44.60	BC150	96.80
2"	AC200	47.40	BC200	112.90
2½"	AC250	56.75	BC250	165.00
3"	AC300	69.00	BC300	178.00
4"	AC400	101.55	BC400	303.00
6"	AC600	223.65	BC600	710.00
8"	AC800 ¹	568.00	---	---

Size	Plated Malleable Iron		316 Stainless Steel	
	Part #	Price/E	Part #	Price/E
¾" x ½"	---	---	RC050BL	\$91.00
¾"	IC075	\$66.25	RC075BL	93.50
1"	IC100	52.80	RC100BL	97.20
1¼"	---	---	RC125BL	144.70
1½"	IC150	63.00	RC150BLNO	130.15
2"	IC200	85.50	RC200BLNO	116.80
3"	IC300	108.70	RC300BL	210.40
4"	IC400 ²	150.00	RC400BLNO	297.00
6"	IC600 ²	391.00	---	---

¹ Dixon® and Boss-Lock™ cam & groove couplings *do not interchange in the ½" and 8" sizes.*

The 8" Dixon® design has 4 cam arms, Boss-Lock™ design has 2 cam arms. 

Boss-Lock™ Type C Coupler x Hose Shank with Collar

Features:

- design provides greater resistance to end pull than conventional band clamps and are designed for use with Strap-Grip Saddles
 - saddles are sold in pairs and designed for use with 3/4" or 5/8" wide band clamps
 - bands must be purchased separately
- band clamps should first be applied to the OD to seal the hose, then Strap-Grip saddles should be banded over the initial clamp to anchor the fitting in the hose



Size	316 Stainless Steel	
	Part #	Price/E
1"	RC100CEZ	\$120.20
1½"	RC150CEZ	170.00
2"	RC200CEZ	152.25

Boss-Lock™ Notched Type C Coupler x Hose Shank

Features:

- coupling can be removed from a damaged hose by cutting away the ferrule, without necessarily damaging the fitting, *after inspection of the fitting to determine its suitability for reuse*, it can be reinstalled into another hose by using a *new ferrule*
- system allows you to better manage your inventories, you can stock one coupling and two ferrules, and cover the same hose range with less inventory, *you must purchase a fitting and the matching ferrule to create an assembly*
- for use with notched ferrules on page F-22

Dixon® stems and ferrules are specifically designed to be used together as a coupling system. Due to differences in dimensions and tolerances for safety reasons, do not use other manufacturer's stems or ferrules with Dixon® products.

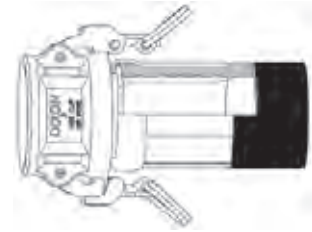

crimped assembly

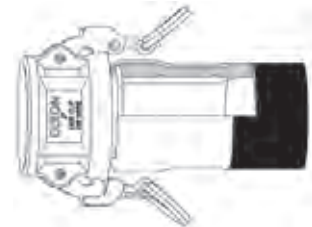

swaged assembly

Size	316 Stainless Steel	
	Part #	Price/E
1½"	RC150BLNO	\$130.15
2"	RC200BLNO	116.80
3"	RC300BLNO	199.40
4"	RC400BLNO	297.00

Contact Dixon® for swage and crimp recommendations.

EZ Boss-Lock™ Type C Coupler x Hose Shank

Cam & Groove



356T6 aluminum



brass



316 stainless steel

Features:

- Couplers are supplied standard with a Buna-N gasket. Other gasket types are available on pages D-48 to D-50

Size	356T6 Aluminum		Brass		316 Stainless Steel	
	Part #	Price/E	Part #	Price/E	Part #	Price/E
3/4" x 1/2"	---	---	---	---	RC050EZ	\$107.00
3/4"	AC075EZ	\$60.80	BC075EZ	\$108.70	RC075EZ	99.00
1"	AC100EZ	68.80	BC100EZ	112.00	RC100EZCR	110.80
1 1/4"	---	---	BC125EZ	160.00	RC125EZCR	163.80
1 1/2"	AC150EZ	72.80	BC150EZ	129.00	RC150EZNO	113.75
2"	AC200EZ	78.40	BC200EZ	145.90	RC200EZNO	121.30
2 1/2"	AC250EZ	89.25	---	---	---	---
3"	AC300EZ	114.40	BC300EZ	235.00	RC300EZCR	210.00
4"	AC400EZ	146.00	BC400EZ	340.00	RC400EZCR	315.00
6"	AC600EZ	336.00	---	---	RC600EZCR	599.00
8"	AC800EZ ¹	633.45	---	---	---	---

¹ Dixon® and Boss-Lock™ cam & groove couplings *do not interchange in the 8" and 1/2" sizes.* The 8" Dixon® design has 4 cam arms, Boss-Lock™ design has 2 cam arms. *Under no circumstances should the EZ Boss-Lock™ cam arms be used on any fitting not specifically designed for their use.* See pages D-3 and D-46 for further specifications.



EZ Boss-Lock™ Type C Coupler x Phono Finish Shank

Applications:

- The shank design on these fittings was developed specifically for chemical transport hoses having Crosslinked Polyethylene (XLPE) or Ultra High Molecular Weight Polyethylene (UHMW) tubes, where shank retention can be a problem when using conventional band clamps.

Features:

- in testing tank transport hoses from a wide variety of manufacturers, the Boss-Lock™ PF fitting showed significant improvement in hose coupling retention over the conventional cam & groove shank design
- for best results we recommend the use of 3/4" wide band clamps found on page F-15
- other sizes available, consult Dixon® for pricing and availability



Size	316 Stainless Steel		Optional Qty
	Part #	Price/E	
2"	RC200EZPF	\$180.00	10
3"	RC300EZPF	275.00	5

EZ Boss-Lock™ Swaged Type C Coupler with Ferrule

Applications:

- Developed specifically for chemical transport hoses having Crosslinked Polyethylene (XLPE) or Ultra High Molecular Weight Polyethylene (UHMW) tubes. Swaged Boss-Lock™ provides you with a permanently attached cam & groove fitting when superior coupling retention is required.

Features:

- in testing tank transport hoses from a wide variety of manufacturers, the swaged Boss-Lock™ fitting proved itself to be the clear winner in overall performance
- available on special order, other sizes or hose OD's, consult Dixon® for pricing and availability
- special equipment required for installation*, consult Dixon® for pricing and availability or refer to page C-17 for more information



Size	Hose OD		316 Stainless Steel	
	from	to	Part #	Price/E
¾"	1-6/64"	1-22/64"	RC075EZ-70	\$130.70
1"	1-29/64"	1-35/64"	RC100EZ-20	137.10
1"	1-36/64"	1-44/64"	RC100EZ-70	141.40

EZ Boss-Lock™ Notched Type C Coupler x Hose Shank

Features:

- coupling can be removed from a damaged hose by cutting away the ferrule, without necessarily damaging the fitting, *after inspection of the fitting to determine its suitability for reuse*, it can be reinstalled into another hose by using a *new ferrule*
- system allows you to better manage your inventories, you can stock one coupling and two ferrules, and cover the same hose range with less inventory, *you must purchase a fitting and the matching ferrule to create an assembly*
- for use with notched ferrules on page F-22

Size	316 Stainless Steel	
	Part #	Price/E
1½"	RC150EZNO	\$113.75
2"	RC200EZNO	121.30
3"	RC300EZNO	208.20
4"	RC400EZNO	310.85



Dixon® stems and ferrules are specifically designed to be used together as a coupling system. Due to differences in dimensions and tolerances for safety reasons, do not use other manufacturer's stems or ferrules with Dixon® products.



Dixon® Type D Coupler x Female NPT

Cam & Groove



356T6 aluminum



aluminum hard coat



brass



unplated malleable iron



316 stainless steel

Features:

- Finger rings are not supplied on ½" - 1" Dixon® couplings.
- ½" Dixon® coupler has only one cam arm.
- Couplers are supplied standard with a Buna-N gasket. Other gasket types are available on pages D-48 to D-50.

Size	356T6 Aluminum		Aluminum Hard Coat		Brass	
	Part #	Price/E	Part #	Price/E	Part #	Price/E
½"	50-D-AL ¹	\$25.80	---	---	50-D-BR ¹	\$39.00
¾"	75-D-AL	25.60	---	---	75-D-BR	50.70
1"	100-D-AL	26.25	---	---	100-D-BR	49.60
1¼"	125-D-AL	49.50	---	---	125-D-BR	87.70
1½"	150-D-AL	32.75	150-D-ALH	\$53.80	150-D-BR	72.50
2"	200-D-AL	36.00	200-D-ALH	59.00	200-D-BR	91.00
2½"	250-D-AL	64.15	---	---	250-D-BR	137.45
3"	300-D-AL	55.00	300-D-ALH	81.60	300-D-BR	159.00
4"	400-D-AL	77.90	400-D-ALH	125.00	400-D-BR	239.00
5"	500-D-AL	130.00	---	---	500-D-BR	462.00
6"	600-D-AL	177.00	600-D-ALH	260.00	600-D-BR	645.00
8"	800-D-AL ^{1,2}	777.00	---	---	---	---

¹ Dixon® and Boss-Lock™ cam & groove couplings *do not interchange in the ½" and 8" sizes.*

² The 8" Dixon® design has 4 cam arms, Boss-Lock™ design has 2 cam arms.



Size	Unplated Malleable Iron		316 Stainless Steel	
	Part #	Price/E	Part #	Price/E
½"	---	---	50-D-SS	\$70.60
¾"	---	---	75-D-SS	76.40
1"	---	---	100-D-SS	80.00
1¼"	---	---	125-D-SS	133.00
1½"	150-D-MI	\$55.00	150-D-SS	108.15
2"	200-D-MI	56.95	200-D-SS	117.70
2½"	---	---	250-D-SS	238.00
3"	300-D-MI	99.75	300-D-SS	219.30
4"	400-D-MI ¹	124.50	400-D-SS	306.00
5"	500-D-MI	211.00	500-D-SS	535.00
6"	---	---	600-D-SS	620.00

¹ ductile iron

Boss-Lock™ Type D Coupler x Female NPT

Features:

- All Boss-Lock™ couplers are supplied with pull-ring safety clips.
- Couplers are supplied standard with a Buna-N gasket. Other gasket types are available on pages D-48 to D-50.

Size	356T6 Aluminum		Brass	
	Part #	Price/E	Part #	Price/E
3/4" x 1/2"	AD050 ¹	\$46.40	BD050 ¹	\$61.95
3/4"	AD075	42.60	BD075	60.60
1"	AD100	39.20	BD100	66.50
1 1/4"	AD125	48.40	BD125	85.00
1 1/2"	AD150	43.00	BD150	82.00
2"	AD200	44.40	BD200	99.60
2 1/2"	AD250	67.40	BD250	171.00
3"	AD300	67.60	BD300	187.00
4"	AD400	87.85	BD400	255.00
5"	AD500	141.00	---	---
6"	AD600	224.80	BD600	632.00
8"	AD800 ¹	526.70	---	---



356T6 aluminum



brass

Size	Plated Malleable Iron		316 Stainless Steel	
	Part #	Price/E	Part #	Price/E
3/4" x 1/2"	---	---	RD050BL ¹	\$105.00
3/4"	ID075	\$52.10	RD075BL	90.60
1"	ID100	55.30	RD100BL	92.20
1 1/4"	---	---	RD125BL	130.20
1 1/2"	ID150	66.65	RD150BL	119.40
2"	ID200	78.70	RD200BL	132.90
3"	ID300	113.50	RD300BL	248.00
4"	ID400	129.50	RD400BL	323.00
6"	ID600 ²	418.00	---	---



plated malleable iron



316 stainless steel

¹ Dixon® and Boss-Lock™ cam & groove couplings *do not interchange in the 1/2" and 8" sizes.*

The 8" Dixon® design has 4 cam arms, Boss-Lock™ design has 2 cam arms.

² ductile iron



EZ Boss-Lock™ Type D Coupler x Female NPT

Feature:

- Couplers are supplied standard with a Buna-N gasket. Other gasket types are available on pages D-48 to D-50.

Under no circumstances should the EZ Boss-Lock™ cam arms be used on any fitting not specifically designed for their use. See pages D-3 and D-46 for further specifications 



356T6 aluminum



brass



316 stainless steel



heavy duty 316 stainless steel

Size	356T6 Aluminum		Brass	
	Part #	Price/E	Part #	Price/E
3/4" X 1/2"	---	---	---	---
3/4"	AD075EZ	\$67.25	BD075EZ	\$105.00
1"	AD100EZ	70.55	BD100EZ	111.00
1 1/4"	---	---	BD125EZ	142.00
1 1/2"	AD150EZ	76.90	BD150EZ	123.00
2"	AD200EZ	75.25	BD200EZ	143.50
2 1/2"	AD250EZ	94.30	BD250EZ	200.00
3"	AD300EZ	120.10	BD300EZ	253.00
4"	AD400EZ	138.20	BD400EZ	310.00
5"	AD500EZ	205.00	---	---
6"	AD600EZ	327.00	---	---
8"	AD800EZ ^{1,2}	536.00	---	---

Size	316 Stainless Steel		Heavy Duty 316 Stainless Steel	
	Part #	Price/E	Part #	Price/E
3/4" X 1/2"	RD050EZ ¹	\$121.50	---	---
3/4"	RD075EZ	106.50	---	---
1"	RD100EZ	107.20	---	---
1 1/4"	RD125EZ	141.70	---	---
1 1/2"	RD150EZ	145.80	---	---
2"	RD200EZ	147.00	---	---
2 1/2"	RD250EZ	265.00	---	---
3"	RD300EZ	278.00	RD300EZHD ³	\$265.00
4"	RD400EZ	337.60	RD400EZHD ⁴	420.00
5"	---	---	---	---
6"	RD600EZ	550.00	---	---
8"	---	---	---	---

¹ Dixon® and Boss-Lock™ cam & groove couplings *do not interchange in the 8" and 1/2" sizes.* 

² The 8" Dixon® design has 4 cam arms, Boss-Lock™ design has 2 cam arms.

³ pressure rating of **400 PSI**

⁴ pressure rating of **300 PSI**

Boss-Lock™ Type E Adapter x Hose Shank

Cam & Groove

Size	356T6 Aluminum		Aluminum Hard Coat		Brass	
	Part #	Price/E	Part #	Price/E	Part #	Price/E
1/2"	50-E-AL	\$16.00	---	---	50-E-BR	\$25.50
3/4" x 1/2"	7550-E-AL	13.00	---	---	---	---
3/4"	75-E-AL	12.30	---	---	75-E-BR	26.00
1"	100-E-AL	18.10	---	---	100-E-BR	42.50
1 1/4"	125-E-AL	20.30	---	---	125-E-BR	55.15
1 1/2"	150-E-AL	21.00	150-E-ALH	\$43.15	150-E-BR	64.85
2"	200-E-AL	24.20	200-E-ALH	41.25	200-E-BR	89.50
2 1/2"	250-E-AL	35.50	---	---	250-E-BR	121.00
3"	300-E-AL	38.85	300-E-ALH	62.00	300-E-BR	146.55
4"	400-E-AL	70.95	400-E-ALH	105.00	400-E-BR	243.00
5"	500-E-AL	107.00	---	---	---	---
6"	600-E-AL	147.70	600-E-ALH	210.00	600-E-BR	715.25
8" DIX	800-E-AL ¹	567.00	---	---	---	---
8" BL	801-E-AL ¹	584.50	---	---	---	---



356T6 aluminum



aluminum hard coat



brass



unplated malleable iron



plated malleable iron



316 stainless steel

¹ Dixon® and Boss-Lock™ cam & groove couplings do not interchange in the 1/2" and 8" sizes.

Pressure rating is based on the seal of the mating part. See ratings on page D-5.



Size	Unplated Malleable Iron		Plated Malleable Iron		316 Stainless Steel	
	Part #	Price/E	Part #	Price/E	Part #	Price/E
1/2"	---	---	---	---	50-E-SS	\$46.35
3/4" x 1/2"	---	---	---	---	7550-E-SS	55.20
3/4"	---	---	75-E-PM	\$25.60	75-E-SS	49.20
1"	---	---	100-E-PM	28.10	100-E-SS	51.00
1 1/4"	---	---	125-E-PM	31.00	125-E-SS	72.10
1 1/2"	150-E-MI	\$34.25	150-E-PM	37.15	150-E-SS	72.35
2"	200-E-MI	41.45	200-E-PM	48.20	200-E-SS	76.35
2 1/2"	---	---	---	---	250-E-SS	198.00
3"	300-E-MI ^{1,2}	53.20	300-E-PM ^{1,2}	60.00	300-E-SS	141.50
4"	400-E-MI ^{1,2}	86.35	400-E-PM ^{1,2}	99.75	400-E-SS	278.00
5"	---	---	---	---	500-E-SS	420.00
6"	600-E-MI ^{1,2}	184.80	600-E-PM ^{1,2}	231.00	600-E-SS	554.00

¹ suitable for King Crimp™ sleeves and ferrules, see pages C-42 to C-45

² ductile iron

Boss-Lock™ Type E Adapter x Phono Finish Shank

Applications:

- Shank design developed specifically for chemical transport hoses having Crosslinked Polyethylene (XLPE) or Ultra High Molecular Weight Polyethylene (UHMW) tubes, where shank retention can be a problem when using conventional band clamps.

Features:

- When testing tank transport hoses from a wide variety of manufacturers, the Boss-Lock™ PF fitting showed significant improvement in hose coupling retention over the conventional cam and groove shank design.
- for best results we recommend the use of 3/4" wide band clamps found on page F-15
- other sizes available, consult Dixon® for pricing and availability



Size	316 Stainless Steel		Optional Qty
	Part #	Price/E	
2"	RE200PF	\$153.60	10

Boss-Lock™ Swaged Type E Adapter with Ferrule



Applications:

- Developed specifically for chemical transport hoses having Crosslinked Polyethylene (XLPE) or Ultra High Molecular Weight Polyethylene (UHMW) tubes.

Features:

- provides a permanently attached cam and groove fitting when superior coupling retention is required
- testing tank transport hoses from a wide variety of manufacturers proved the swaged Boss-Lock™ fitting to be the leader in overall performance
- other sizes or hose OD's (available on special order), consult Dixon® for pricing and availability
- *special equipment required for installation*, consult Dixon® for pricing and availability or refer to page C-17 for more information

Size	Hose OD		316 Stainless Steel	
	from	to	Part #	Price/E
¾"	1-6/64"	1-22/64"	RE075-1370	\$91.50
1"	1-29/64"	1-35/64"	RE100-1620	69.00
1"	1-36/64"	1-44/64"	RE100-1770	76.30

Boss-Lock™ Notched Type E Adapter x Hose Shank



Features:

- can be removed from a damaged hose by cutting away the ferrule without necessarily damaging the fitting, *after inspection of the fitting to determine its suitability for reuse*, it can be reinstalled into another hose by using a *new ferrule*
- system allows you to better manage your inventory, stock one coupling and two ferrules and cover the same hose range with less inventory, *you must purchase a fitting and the matching ferrule to create an assembly*
- for use with notched ferrules on page F-22

Dixon® stems and ferrules are specifically designed to be used together as a coupling system. Due to differences in dimensions and tolerances for safety reasons, do not use other manufacturer's stems or ferrules with Dixon® products.



Size	316 Stainless Steel	
	Part #	Price/E
1½"	RE150NO	\$61.00
2"	RE200NO	65.30
3"	RE300NO	126.00
4"	RE400NO	246.90

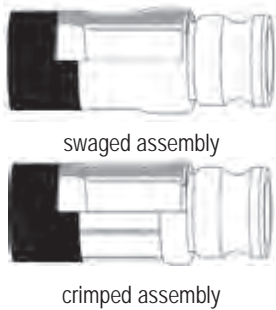

swaged assembly

crimped assembly

Dixon® Notched NOS Type E Adapter x NOS shank

Features:

- system allows you to better manage your inventories, you can stock one stem and two ferrules, and cover the same hose range with less inventory, *you must purchase a fitting and the matching ferrule to create an assembly*
- for hose outside diameters of 2-4/64" and below, *the couplings are crimp only*
- for hose outside diameters of 2-5/64" and above, the couplings can be crimped or swaged
- for use with notched ferrules on page F-22
- see page E-6 for male NPT notched NOS fittings



Size	316 Stainless Steel	
	Part #	Price/E
1½"	150ENOSSS ¹	\$38.00
2"	200ENOSSS	50.60
3"	300ENOSSS	103.55

¹ part will be discontinued as stock is depleted

Only use the NOS shank with the NOS ferrules.

Due to differences in dimensions and tolerances for safety reasons, do not use other manufacturer's stems or ferrules with Dixon® products.



Boss-Lock™ Type F Adapter x Male NPT

• Pressure rating is based on the seal of the mating part. See ratings on page D-5.



Cam & Groove

Size	356T6 Aluminum		Aluminum Hard Coat		Brass	
	Part #	Price/E	Part #	Price/E	Part #	Price/E
1/2"	50-F-AL ¹	\$11.00	---	---	50-F-BR ¹	\$23.85
3/4" x 1/2"	7550-F-AL	24.00	---	---	7550-F-BR	55.50
3/4"	75-F-AL	12.30	---	---	75-F-BR	28.10
1"	100-F-AL	15.95	---	---	100-F-BR	36.10
1 1/4"	125-F-AL	19.75	---	---	125-F-BR	54.25
1 1/2"	150-F-AL	19.90	150-F-ALH	\$34.10	150-F-BR	47.45
2"	200-F-AL	21.10	200-F-ALH	38.30	200-F-BR	57.30
2 1/2"	250-F-AL	38.30	---	---	250-F-BR	132.50
3"	300-F-AL	38.25	300-F-ALH	62.90	300-F-BR	152.00
4"	400-F-AL	72.50	400-F-ALH	109.00	400-F-BR	218.00
5"	500-F-AL	133.00	---	---	---	---
6"	600-F-AL	149.00	600-F-ALH	220.45	600-F-BR	585.00
8" DIX	800-F-AL ¹	450.00	---	---	---	---
8" BL	801-F-AL ¹	460.00	---	---	---	---



356T6 aluminum



aluminum hard coat



brass



unplated malleable iron



plated malleable iron



316 stainless

Size	Unplated Malleable Iron		Plated Malleable Iron		316 Stainless Steel	
	Part #	Price/E	Part #	Price/E	Part #	Price/E
1/2"	---	---	---	---	50-F-SS	\$48.40
3/4" x 1/2"	---	---	---	---	7550-F-SS	73.00
3/4"	---	---	75-F-PM	\$24.75	75-F-SS	55.30
1"	---	---	100-F-PM	22.80	100-F-SS	60.75
1 1/4"	---	---	---	---	125-F-SS	84.70
1 1/2"	150-F-MI	\$33.10	150-F-PM	35.25	150-F-SS	79.30
2"	200-F-MI	38.75	200-F-PM	43.40	200-F-SS	83.00
2 1/2"	---	---	---	---	250-F-SS	285.00
3"	300-F-MI	73.25	300-F-PM	76.00	300-F-SS	180.00
4"	400-F-MI	108.00	400-F-PM	113.20	400-F-SS	292.30
6"	---	---	600-F-PM	275.00	600-F-SS	415.80

¹ Dixon® and Boss-Lock™ cam & groove couplings do not interchange in the 1/2" and 8" sizes.



Dixon® Type DC Dust Caps

Cam & Groove



356T6 aluminum



aluminum hard coat



brass



unplated malleable iron



316 stainless steel

Features:

- Finger rings are not supplied on ½" - 1" Dixon® couplings.
- ½" Dixon® has only one cam arm.
- Buna-N gasket supplied standard, other gaskets available on pages D-48 to D-50

Size	356T6 Aluminum		Aluminum Hard Coat		Brass	
	Part #	Price/E	Part #	Price/E	Part #	Price/E
½"	50-DC-AL ¹	\$23.60	---	---	50-DC-BR ¹	\$34.25
¾"	75-DC-AL	25.85	---	---	75-DC-BR	45.30
1"	100-DC-AL	24.85	---	---	100-DC-BR	52.00
1½"	150-DC-AL	32.75	150-DC-ALH	\$47.00	150-DC-BR	77.00
2"	200-DC-AL	30.20	200-DC-ALH	48.00	200-DC-BR	72.00
2½"	250-DC-AL	54.20	---	---	---	---
3"	300-DC-AL	41.10	300-DC-ALH	65.30	300-DC-BR	105.00
4"	400-DC-AL	54.00	400-DC-ALH	96.50	400-DC-BR	153.00
5"	500-DC-AL	86.40	---	---	500-DC-BR	336.00
6"	600-DC-AL	132.80	600-DC-ALH	205.00	---	---
8"	800-DC-AL ^{1,2}	534.00	---	---	---	---

¹ Dixon® and Boss-Lock™ cam & groove couplings *do not interchange in the ½" and 8" sizes.*

² The 8" Dixon® dust cap has 2 cam arms.



Size	Unplated Malleable Iron		316 Stainless Steel	
	Part #	Price/E	Part #	Price/E
½"	---	---	50-DC-SS ¹	\$66.95
¾"	---	---	75-DC-SS	63.75
1"	---	---	100-DC-SS	71.50
1½"	---	---	150-DC-SS	89.00
2"	200-DC-MI	\$53.00	200-DC-SS	105.00
2½"	---	---	250-DC-SS	209.00
3"	300-DC-MI	67.20	300-DC-SS	133.00
4"	400-DC-MI	106.00	400-DC-SS	195.00
5"	---	---	500-DC-SS	415.00
6"	---	---	600-DC-SS	490.00

¹ Dixon® and Boss-Lock™ cam & groove couplings *do not interchange in the ½" and 8" sizes.*



Dixon® Lockable Dust Caps

Features:

- Buna-N gasket standard, other gaskets available on pages D-48 to D-50
- Dust caps and dust plugs are not to be used in pressure applications for safety and environmental reasons.



Size	356T6 Aluminum			Brass		
	Part #	Price/E	Optional Qty	Part #	Price/E	Optional Qty
1½"	150DC-LAL	\$48.25	10	150DC-LBR	\$98.70	10
2"	200DC-LAL	52.00	10	200DC-LBR	98.55	10
3"	300DC-LAL	65.80	10	300DC-LBR	119.00	10
4"	400DC-LAL	89.20	10	---	---	---
6"	600DC-LAL	203.00	5	---	---	---



Feature:

- angled, ergonomic thumb release

Size	316 Stainless Steel	
	Part #	Price/E
1½"	150DC-LSS	\$119.00
2"	200DC-LSS	163.40
3"	300DC-LSS	197.00
4"	400DC-LSS	256.90



Boss-Lock™ Type H Dust Caps

Features:

- supplied with pull-ring safety clips
- Buna-N gasket standard, other gaskets available on pages D-48 to D-50

Size	356T6 Aluminum		Brass	
	Part #	Price/E	Part #	Price/E
1"	AH100	\$40.50	BH100	\$67.10
1¼"	AH125	41.10	BH125	81.00
1½"	AH150	43.20	BH150	84.90
2"	AH200	44.30	BH200	108.70
2½"	AH250	48.20	BH250	129.00
3"	AH300	71.40	BH300	160.00
4"	AH400	79.00	BH400	210.00
6"	AH600	218.35	BH600	520.00
8"	AH800¹	438.80	---	---



356T6 aluminum



brass

Size	Plated Malleable Iron		316 Stainless Steel	
	Part #	Price/E	Part #	Price/E
¾"	---	---	RH075BL	\$76.80
1"	---	---	RH100BL	81.95
1¼"	---	---	RH125BL	122.30
1½"	IH150	\$59.00	RH150BL	105.25
2"	IH200	76.75	RH200BL	122.95
3"	IH300	98.75	RH300BL	188.65
4"	IH400	125.70	RH400BL	224.00
6"	IH600	315.00	---	---



plated malleable iron



316 stainless steel

- ¹ Dixon® and Boss-Lock™ cam & groove couplings *do not interchange in the 8" sizes.*
- The 8" Boss-Lock™ design has 2 cam arms.
 - Dust caps and dust plugs are not to be used in pressure applications for safety and environmental reasons.



EZ Boss-Lock™ Type H Dust Caps

Cam & Groove



356T6 aluminum



brass



316 stainless steel

Feature:

- Buna-N gasket standard, other gaskets available on pages D-48 to D-50

Size	356T6 Aluminum		Brass		316 Stainless Steel	
	Part #	Price/E	Part #	Price/E	Part #	Price/E
3/4"	---	---	---	---	RH075EZ	\$93.90
1"	AH100EZ	\$71.30	BH100EZ	\$114.00	RH100EZ	97.60
1 1/4"	---	---	---	---	RH125EZ	135.85
1 1/2"	AH150EZ	72.00	BH150EZ	123.00	RH150EZ	126.30
2"	AH200EZ	72.80	BH200EZ	130.00	RH200EZ	143.45
2 1/2"	AH250EZ	80.00	---	---	---	---
3"	AH300EZ	103.50	BH300EZ	244.00	RH300EZ	199.50
4"	AH400EZ	122.40	---	---	RH400EZ	245.00
6"	AH600EZ	260.00	---	---	RH600EZ	467.00

- Under no circumstances should the EZ Boss-Lock™ cam arms be used on any fitting not specifically designed for their use. See pages D-3 and D-46 for further specifications.
- Dust caps and dust plugs are not to be used in pressure applications for safety and environmental reasons.



Boss-Lock™ Type DP Dust Plugs

Cam & Groove

Size	356T6 Aluminum		Aluminum Hard Coat		Brass	
	Part #	Price/E	Part #	Price/E	Part #	Price/E
1/2"	---	---	---	---	50-DP-BR	\$26.00
3/4"	75-DP-AL	\$13.35	---	---	75-DP-BR	37.05
1"	100-DP-AL	16.00	---	---	100-DP-BR	27.55
1 1/4"	125-DP-AL	17.70	---	---	125-DP-BR	52.95
1 1/2"	150-DP-AL	18.60	150-DP-ALH	\$32.25	150-DP-BR	52.00
2"	200-DP-AL	17.85	200-DP-ALH	36.20	200-DP-BR	52.25
2 1/2"	250-DP-AL	27.35	---	---	---	---
3"	300-DP-AL	25.80	300-DP-ALH	47.00	300-DP-BR	78.50
4"	400-DP-AL	38.25	400-DP-ALH	70.00	400-DP-BR	170.00
5"	500-DP-AL	64.25	---	---	---	---
6"	600-DP-AL	83.00	600-DP-ALH	130.60	600-DP-BR	540.00
8" DIX	800-DP-AL ¹	355.00	---	---	---	---
8" BL	801-DP-AL ¹	361.00	---	---	---	---



356T6 aluminum



aluminum hard coat



brass

Size	Unplated Malleable Iron		Plated Malleable Iron		316 Stainless Steel	
	Part #	Price/E	Part #	Price/E	Part #	Price/E
1/2"	---	---	---	---	50-DP-SS ¹	\$40.60
3/4"	---	---	---	---	75-DP-SS	42.40
1"	---	---	---	---	100-DP-SS	44.50
1 1/4"	---	---	125-DP-PM	\$31.00	125-DP-SS	47.80
1 1/2"	150-DP-MI	\$26.90	150-DP-PM	34.05	150-DP-SS	56.90
2"	200-DP-MI	32.15	200-DP-PM	35.30	200-DP-SS	64.00
2 1/2"	---	---	250-DP-PM	37.10	250-DP-SS	159.00
3"	300-DP-MI	41.10	300-DP-PM	44.80	300-DP-SS	102.70
4"	400-DP-MI	68.90	400-DP-PM	76.50	400-DP-SS	175.00
6"	---	---	---	---	600-DP-SS	378.00



unplated malleable iron



plated malleable iron



316 stainless steel

¹ Dixon® and Boss-Lock™ cam & groove couplings do not interchange in the 1/2" and 8" sizes.



Type A Female NPT x Male Adapter

Cam & Groove



Size	Hastelloy® CW12MW	
	Part #	Price/E
1"	100-A-HA	\$290.00
1½"	150-A-HA	360.00
2"	200-A-HA	405.00
3"	300-A-HA	800.00

Type E Male Adapter x House Shank



Size	Hastelloy® CW12MW	
	Part #	Price/E
1"	100-E-HA	\$271.00
1½"	150-E-HA	345.00
2"	200-E-HA	445.00
3"	300-E-HA	1300.00

Type F Male NPT x Male Adapter



Size	Hastelloy® CW12MW	
	Part #	Price/E
1"	100-F-HA	\$245.00
1½"	150-F-HA	505.00
2"	200-F-HA	620.00
3"	300-F-HA	995.00

EZ Boss-Lock™ Type B Coupler x Hose Shank

Feature:

- couplers supplied with FKM gaskets

Materials:

- EZ Boss-Lock™ cam arms: 316 stainless steel
- pins: 302 stainless steel
- rings: yellow zinc plated 12 gauge steel wire



Size	Hastelloy® CW12MW	
	Part #	Price/E
1"	HAB100EZ	\$420.40
1½"	HAB150EZ	525.40
2"	HAB200EZ	568.30
3"	HAB300EZ	1100.00

EZ Boss-Lock™ Type C Coupler x Hose Shank

Feature:

- couplers supplied with FKM gaskets

Materials:

- EZ Boss-Lock™ cam arms: 316 stainless steel
- pins: 302 stainless steel
- rings: yellow zinc plated 12 gauge steel wire



Size	Hastelloy® CW12MW	
	Part #	Price/E
1"	HAC100EZ	\$460.00
1½"	HAC150EZ	560.00
2"	HAC200EZ	611.00
3"	HAC300EZ	1700.00

EZ Boss-Lock™ Type D Coupler x Female NPT

Feature:

- couplers supplied with FKM gaskets

Materials:

- EZ Boss-Lock™ cam arms: 316 stainless steel
- pins: 302 stainless steel
- rings: yellow zinc plated 12 gauge steel wire



Size	Hastelloy® CW12MW	
	Part #	Price/E
1"	HAD100EZ	\$492.00
1½"	HAD150EZ	615.00
2"	HAD200EZ	645.00
3"	HAD300EZ	1200.00

Dixon® Coupler x Adapter with Port (Type DA)

Cam & Groove



Feature:

- Buna-N gasket standard with a, other gaskets available on pages D-48 to D-50

Size	Port	316 Stainless Steel	
		Part #	Price/E
3" x 3"	1/4"	300DAT25SS	\$394.00
3" x 3"	3/8"	300DAT38SS	394.00
3" x 3"	1/2"	300DAT50SS	394.00
3" x 3"	3/4"	300DAT75SS	394.00

Note: In reducing cam & groove couplings, the coupler is the first size in the part number; (i.e., a 4030-DA-AL is a 4" coupler to a 3" adapter).

Dixon® Reducing Coupler x Adapter (Type DA)



4030-DA-SS



4060-DA-AL



2015-DA-AL



5060-DA-AL

Size	356T6 Aluminum		Optional Qty	316 Stainless Steel	
	Part #	Price/E		Part #	Price/E
1" x 1 1/2"	1015-DA-AL ¹	\$162.75	---	1015-DA-SS ¹	\$315.00
1 1/2" x 1"	1510DAAL	72.70	---	1510-DA-SS ¹	315.00
1 1/2" x 2"	1520-DA-AL	88.00	10	1520-DA-SS	295.00
2" x 1"	2010-DA-AL ¹	162.50	---	2010-DA-SS	251.60
2" x 1 1/2"	2015-DA-AL	61.00	10	2015-DA-SS	272.00
2" x 2 1/2"	2025-DA-AL ¹	170.00	---	2025-DA-SS ¹	525.00
2" x 3"	2030-DA-AL	75.20	10	2030-DA-SS	291.70
2" x 4"	2040-DA-AL	119.00	---	2040-DA-SS ¹	510.00
2 1/2" x 2"	---	---	---	2520-DA-SS ¹	540.00
2 1/2" x 3"	---	---	---	2530-DA-SS ¹	640.25
3" x 1 1/2"	3015-DA-AL	92.70	---	3015-DA-SS ¹	410.00
3" x 2"	3020-DA-AL	77.40	10	3020-DA-SS	285.30
3" x 2 1/2"	3025-DA-AL ¹	180.00	---	3025-DA-SS ¹	490.00
3" x 4"	3040-DA-AL	107.10	10	3040-DA-SS	788.00
3" x 6"	3060-DA-AL ¹	300.00	---	3060-DA-SS ¹	719.00
4" x 2"	4020-DA-AL	109.00	10	4020-DA-SS ¹	561.00
4" x 2 1/2"	4025-DA-AL	167.50	---	4025-DA-SS ¹	732.00
4" x 3"	4030-DA-AL	115.30	5	4030-DA-SS	535.00
4" x 5"	4050-DA-AL	226.80	5	---	---
4" x 6"	4060-DA-AL	191.30	2	4060-DA-SS ¹	1100.00
5" x 3"	5030-DA-AL ¹	287.75	2	5030-DA-SS ¹	725.00
5" x 4"	5040-DA-AL	187.20	2	5040-DA-SS ¹	824.00
5" x 6"	5060-DA-AL ¹	399.00	---	5060-DA-SS ¹	950.00
6" x 3"	6030-DA-AL	204.70	2	6030-DA-SS ¹	1158.75
6" x 4"	6040-DA-AL	199.75	2	6040-DA-SS	1200.00
6" x 5"	6050-DA-AL	331.35	---	6050-DA-SS ¹	1300.00
8" x 6"	8060-DA-AL ^{1,2}	1100.00	---	---	---

¹ parts are produced as a welded fabrication

² The 8" coupler only has 2 cam arms and only interchanges with Dixon® adapters.



Size	Brass		Opt Qty	Unplated Malleable Iron		Opt Qty
	Part #	Price/E		Part #	Price/E	
3" x 2"	3020-DA-BR	\$305.00	10	3020-DA-MI	\$124.30	10
3" x 4"	3040-DA-BR	424.20	5	---	---	---
4" x 3"	4030-DA-BR	360.00	5	4030-DA-MI	204.00	---
6" x 4"	6040-DA-BR	695.00	---	6040-DA-MI	440.00	---

Boss-Lock™ Reducing Coupler x Adapter (Type DA)

Feature:

- Buna-N gasket standard, other gaskets available on pages D-48 to D-50

Size	356T6 Aluminum		316 Stainless Steel		Optional Qty
	Part #	Price/E	Part #	Price/E	
2" x 3"	ADA2030 ¹	\$189.00	RDA2030BL ¹	\$415.00	10
2½" x 2"	ADA2520 ¹	173.80	---	---	---
2½" x 3"	ADA2530 ¹	295.00	---	---	---
3" x 2"	ADA3020	90.50	RDA3020BL	375.00	10
3" x 4"	ADA3040 ¹	225.75	RDA3040BL ¹	462.00	10
4" x 2"	ADA4020 ¹	252.00	RDA4020BL ¹	639.10	10
4" x 3"	ADA4030	138.60	RDA4030BL	599.00	10
6" x 4"	ADA6040 ¹	523.00	---	---	---
8" x 6"	ADA8060 ^{1,2}	1100.00	---	---	---



¹ parts are produced as a welded fabrication

² The 8" coupler only interchanges with 8" Boss-Lock™ couplings.



Note: In reducing cam & groove couplings, the coupler is the first size in the part number; (i.e., a ADA4030 is a 4" coupler to a 3" adapter).

EZ Boss-Lock™ Reducing Coupler x Adapter (Type DA)

Feature:

- Buna-N gasket standard, other gaskets available on pages D-48 to D-50

Size	356T6 Aluminum		316 Stainless Steel	
	Part #	Price/E	Part #	Price/E
2" x 3"	ADA2030EZ ¹	\$224.30	RDA2030EZ ¹	\$411.95
3" x 2"	ADA3020EZ	137.20	RDA3020EZ	385.80
3" x 4"	ADA3040EZ ¹	272.06	RDA3040EZ ¹	479.86
4" x 2"	ADA4020EZ ¹	294.70	RDA4020EZ ¹	630.00
4" x 3"	ADA4030EZ	194.25	RDA4030EZ	595.00
6" x 4"	ADA6040EZ ¹	581.00	RDA6040EZ	647.00



¹ parts are produced as a welded fabrication

Note: In reducing cam & groove couplings, the coupler is the first size in the part number; (i.e., a ADA4030EZ is a 4" coupler to a 3" adapter).

Dixon® Reducing Coupler x Adapter with Port (Type DA)

Size	Port	316 Stainless Steel	
		Part #	Price/E
3" x 2"	¼"	3020DAT25SS	\$354.00
3" x 2"	⅜"	3020DAT38SS	354.00
3" x 2"	½"	3020DAT50SS	354.00
3" x 2"	¾"	3020DAT75SS	354.00

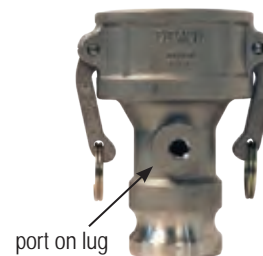

Dixon® Spool Adapters

Feature:

- pressure rating is based on the seal of the mating part, see ratings on page D-5

Cam & Groove



increaser / reducer



same size

Size	356T6 Aluminum		316 Stainless Steel	
	Part #	Price/E	Part #	Price/E
1"	---	---	100-AA-SS	\$102.90
1¼"	---	---	125-AA-SS ¹	375.95
1½"	150-AA-AL	\$36.00	150-AA-SS	111.80
1½" x 2"	1520-AA-AL	45.40	1520-AA-SS	176.00
2"	200-AA-AL	41.25	200-AA-SS	160.00
2" x 3"	2030-AA-AL	64.50	2030-AA-SS	218.00
2" x 4"	2040-AA-AL	114.30	2040-AA-SS ¹	446.00
2½" x 3"	2530-AA-AL ¹	225.45	2530-AA-SS ¹	608.10
2½" x 4"	2540-AA-AL ¹	320.00	---	---
3"	300-AA-AL	65.20	300-AA-SS	261.30
3" x 4"	3040-AA-AL	94.50	3040-AA-SS ¹	520.15
4"	400-AA-AL	85.95	400-AA-SS	359.00
4" x 5"	4050-AA-AL	130.00	---	---
4" x 6"	4060-AA-AL	217.35	4060-AA-SS ¹	995.00
5"	500-AA-AL ¹	270.00	500-AA-SS ¹	875.50
5" x 6"	5060-AA-AL ¹	410.00	---	---
6"	600-AA-AL	236.50	600-AA-SS ¹	970.00

¹ parts are produced as a welded fabrication

Size	Brass	
	Part #	Price/E
2"	200-AA-BR	\$123.75
3"	300-AA-BR	242.05

Dixon® Spool Couplers

Feature:

- Buna-N gasket standard, other gaskets available on pages D-48 to D-50



reducer / increaser



same size

Size	356T6 Aluminum		316 Stainless Steel	
	Part #	Price/E	Part #	Price/E
1½"	---	---	150-DD-SS ¹	\$311.90
2"	200-DD-AL	\$67.70	200-DD-SS	196.25
2" x 3"	2030-DD-AL	110.00	2030-DD-SS	324.00
3"	300-DD-AL	89.75	300-DD-SS	302.30
3" x 4"	3040-DD-AL	125.50	3040-DD-SS ¹	710.00
4"	400-DD-AL	130.00	400-DD-SS ¹	780.00
4" x 5"	4050-DD-AL ¹	395.20	4050-DD-SS ¹	780.00
4" x 6"	4060-DD-AL ¹	357.00	4060-DD-SS	805.00
5"	500-DD-AL ¹	465.00	500-DD-SS	750.00
6"	600-DD-AL ¹	540.00	---	---

¹ parts are produced as a welded fabrication

Boss-Lock™ Spool Couplers

Feature:

- Buna-N gasket standard, other gaskets available on pages D-48 to D-50



reducer / increaser



same size

Size	356T6 Aluminum		316 Stainless Steel	
	Part #	Price/E	Part #	Price/E
2"	ADD200 ¹	\$187.00	RDD200EZ	\$360.85
2" x 3"	ADD2030 ¹	195.00	RDD2030EZ ¹	450.00
3"	ADD300 ¹	270.85	RDD300EZ ¹	548.00
3" x 4"	ADD3040 ¹	320.00	RDD3040EZ ¹	640.00
4"	ADD400 ¹	320.00	RDD400EZ ¹	645.50
6"	---	---	RDD600EZ ¹	1329.00

¹ parts are produced as a welded fabrication

Reducing Type A Adapter x Female NPT

Feature:

- pressure rating is based on the seal of the mating part, see ratings on page D-5

Size	356T6 Aluminum		Optional Qty	316 Stainless Steel		Optional Qty
	Part #	Price/E		Part #	Price/E	
2" x 1½"	2015-A-AL	\$45.95	---	2015-A-SS ¹	\$208.70	---
2" x 3"	2030-A-AL	63.50	10	2030-A-SS	234.00	10
3" x 2"	3020-A-AL	59.75	10	3020-A-SS	295.00	10
3" x 4"	3040-A-AL	74.50	10	---	---	---
4" x 3"	4030-A-AL	68.00	10	4030-A-SS ¹	504.70	---
4" x 6"	4060-A-AL	187.20	5	---	---	---
6" x 4"	6040-A-AL	198.30	4	6040-A-SS ¹	985.00	---



¹ parts are produced as a welded fabrication

Note: In reducing couplings, the cam & groove end is the first size given in the part number. (i.e., a 4030-C-AL is a 4" coupler to a 3" hose shank).

Reducing Type B Coupler x Male NPT

Feature:

- Buna-N gasket standard, other gaskets available on pages D-48 to D-50

Size	356T6 Aluminum		Optional Qty	316 Stainless Steel	
	Part #	Price/E		Part #	Price/E
1½" x 1"	1510-B-AL	\$72.00	10	1510-B-SS ¹	\$320.00
2" x 1½"	2015-B-AL	63.40	10	2015-B-SS ¹	370.00
2" x 3"	2030-B-AL	87.90	---	---	---
3" x 2"	3020-B-AL	81.25	10	3020-B-SS ¹	358.00
3" x 4"	3040-B-AL	107.60	10	---	---
4" x 3"	4030-B-AL	125.25	5	4030-B-SS ¹	495.00



¹ parts are produced as a welded fabrication

Note: In reducing couplings, the cam & groove end is the first size given in the part number. (i.e., a 4030-C-AL is a 4" coupler to a 3" hose shank).

Reducing Type C Coupler x Hose Shank

Feature:

- Buna-N gasket standard, other gaskets available on pages D-48 to D-50

Size	356T6 Aluminum		Optional Qty	316 Stainless Steel	
	Part #	Price/E		Part #	Price/E
1½" x 1"	---	---	---	1510-C-SS	\$262.40
2" x 1½"	2015-C-AL ¹	\$185.00	---	2015-C-SS ¹	260.00
3" x 2"	3020-C-AL	72.50	10	3020-C-SS	342.80
3" x 2½"	---	---	---	3025-C-SS	389.30
3" x 4"	3040-C-AL	130.00	5	---	---
4" x 3"	4030-C-AL	93.10	5	4030-C-SS ¹	600.00
5" x 4"	5040-C-AL ¹	375.00	---	---	---



¹ parts are produced as a welded fabrication

Note: In reducing couplings, the cam & groove end is the first size given in the part number. (i.e., a 4030-C-AL is a 4" coupler to a 3" hose shank).

Reducing Type D Coupler x Female NPT

Cam & Groove



Feature:

- Buna-N gasket standard, other gaskets available on pages D-48 to D-50

Size	356T6 Aluminum		Optional Qty	Brass		316 Stainless Steel	
	Part #	Price/E		Part #	Price/E	Part #	Price/E
1½" x 1"	1510-D-AL ¹	\$70.75	10	---	---	1510-D-SS ¹	\$306.00
2" x 1½"	2015-D-AL	50.15	10	---	---	2015-D-SS	220.00
3" x 2"	3020-D-AL	87.60	10	---	---	3020-D-SS	345.50
4" x 3"	4030-D-AL	127.00	10	4030-D-BR	\$339.10	4030-D-SS ¹	498.00
5" x 4"	5040-D-AL ¹	355.00	---	---	---	---	---
6" x 4"	6040-D-AL ¹	410.00	---	---	---	---	---

¹ parts are produced as a welded fabrication

Note: In reducing couplings, the cam & groove end is the first size given in the part number. (i.e., a 4030-C-AL is a 4" coupler to a 3" hose shank).

Reducing Type E Adapter x Hose Shank

Feature:

- pressure rating is based on the seal of the mating part, see ratings on page D-5



Size	356T6 Aluminum		Optional Qty	316 Stainless Steel	
	Part #	Price/E		Part #	Price/E
1½" x 1"	---	---	---	1510-E-SS	\$236.70
2" x 1½"	2015-E-AL ¹	\$180.00	---	2015-E-SS ¹	218.40
3" x 2"	---	---	---	3020-E-SS ¹	385.00
3" x 2½"	---	---	---	3025-E-SS	199.00
4" x 3"	4030-E-AL	86.80	10	4030-E-SS ¹	550.00
5" x 4"	5040-E-AL ¹	325.00	---	---	---

¹ parts are produced as a welded fabrication

Note: In reducing couplings, the cam & groove end is the first size given in the part number. (i.e., a 4030-B-AL is a 4" coupler to a 3" male NPT).

Reducing Type F Adapter x Male NPT

Feature:

- pressure rating is based on the seal of the mating part, see ratings on page D-5



Size	356T6 Aluminum		Optional Qty	316 Stainless Steel	
	Part #	Price/E		Part #	Price/E
1½" x 2"	1520-F-AL	\$45.00	---	---	---
2" x 1½"	2015-F-AL	45.30	---	2015-F-SS ¹	\$398.00
2" x 3"	2030-F-AL	69.00	---	---	---
3" x 1½"	3015-F-AL	64.60	10	3015-F-SS ¹	418.00
3" x 2"	3020-F-AL	64.25	10	3020-F-SS	410.00
3" x 4"	3040-F-AL	83.30	10	---	---
4" x 3"	4030-F-AL	88.90	10	4030-F-SS	325.00

¹ parts are produced as a welded fabrication

Note: In reducing couplings, the cam & groove end is the first size given in the part number. (i.e., a 4030-C-AL is a 4" coupler to a 3" hose shank).

45° Adapter x Coupler

Features:

- Buna-N gasket standard, other gaskets available on pages D-48 to D-50

Size	356T6 Aluminum		316 Stainless Steel		Unplated Malleable Iron	
	Part #	Price/E	Part #	Price/E	Part #	Price/E
2"	200DA-45AL ¹	\$165.40	200DA-45SS ¹	\$495.00	---	---
3"	300DA-45AL	180.00	300DA-45SS ¹	715.00	---	---
4"	400DA-45AL	239.95	400DA-45SS ¹	960.00	400DA-45MI	\$227.25
6"	600DA-45AL	543.00	---	---	---	---

¹ part is produced as a welded fabrication



Cam & Groove

45° Coupler x Coupler

Size	356T6 Aluminum		316 Stainless Steel	
	Part #	Price/E	Part #	Price/E
2"	200DD-45AL ¹	\$239.00	---	---
3"	300DD-45AL ¹	395.20	300DD-45SS ¹	\$599.00
4"	400DD-45AL	283.50	---	---
6"	600DD-45AL ¹	730.00	---	---

¹ part is produced as a welded fabrication



90° Adapter x Coupler

Size	356T6 Aluminum		316 Stainless Steel	
	Part #	Price/E	Part #	Price/E
1"	---	---	100DA-90SS ¹	\$350.00
1½"	150DA-90AL ¹	\$135.00	150DA-90SS ¹	405.00
2"	200DA-90AL	90.95	200DA-90SS	365.00
3"	300DA-90AL	148.50	300DA-90SS	715.00
4"	400DA-90AL	232.80	400DA-90SS	795.00
5"	500DA-90AL ¹	1500.00	---	---
6"	600DA-90AL	481.25	RDA90600EZ ^{1,2}	2300.00

¹ part is produced as a welded fabrication

² EZ Boss-Lock design (not pictured)



90° Coupler x Coupler

Size	356T6 Aluminum		316 Stainless Steel	
	Part #	Price/E	Part #	Price/E
2"	200DD-90AL	\$179.60	---	---
3"	300DD-90AL ¹	375.00	300DD-90SS ¹	\$565.00
4"	400DD-90AL	198.00	---	---
6"	600DD-90AL	795.00	---	---

¹ part is produced as a welded fabrication



90° Type A Adapter x Female NPT

Feature:

- pressure rating is based on the seal of the mating part, see ratings on page D-5

Size	356T6 Aluminum		316 Stainless Steel	
	Part #	Price/E	Part #	Price/E
1½"	150A-90AL	\$72.90	---	----
2"	200A-90AL	69.75	200A-90SS ¹	\$450.00
3"	300A-90AL	123.00	300A-90SS	487.40
4"	400A-90AL	224.00	---	----

¹ part is produced as a welded fabrication





90° Type B Coupler x Male NPT

Feature:

- Buna-N gasket standard, other gaskets available on pages D-48 to D-50

Size	356T6 Aluminum		316 Stainless Steel	
	Part #	Price/E	Part #	Price/E
1½"	150B-90AL	\$77.00	---	---
2"	200B-90AL	91.00	200B-90SS ¹	\$514.50
3"	---	---	300B-90SS ¹	600.00

¹ Parts are produced as a welded fabrication.

90° Type C Coupler x Hose Shank

Feature:

- Buna-N gasket standard, other gaskets available on pages D-48 to D-50



Size	356T6 Aluminum		Brass		316 Stainless Steel	
	Part #	Price/E	Part #	Price/E	Part #	Price/E
1¼"	---	---	125C-90BR	\$139.00	---	---
1½"	150C-90AL	\$71.90	---	---	150C-90SS	\$390.00
2"	200C-90AL	71.80	200C-90BR	157.00	200C-90SS	340.00
3"	300C-90AL	102.90	---	---	300C-90SS	495.00
4"	400C-90AL	199.30	---	---	400C-90SS ¹	975.00
6"	600C-90AL	478.95	---	---	---	---

¹ part is produced as a welded fabrication

90° Type D Coupler x Female NPT

Feature:

- Buna-N gasket standard, other gaskets available on pages D-48 to D-50



EZ Boss-Lock™ design

Size	356T6 Aluminum		Brass		316 Stainless Steel	
	Part #	Price/E	Part #	Price/E	Part #	Price/E
1"	---	---	---	---	100D-90SS	\$210.00
1¼"	---	---	125D-90BR	\$134.10	---	---
1½"	150D-90AL	\$81.60	150D-90BR	118.00	---	---
2"	200D-90AL	68.30	200D-90BR	153.00	200D-90SS	217.35
3"	300D-90AL	110.00	---	---	300D-90SS	609.75
4"	400D-90AL	150.50	---	---	400D-90SS ¹	1015.00
4"	AD90400EZ ²	235.00	---	---	---	---
6"	600D-90AL	365.00	---	---	---	---

¹ part is produced as a welded fabrication

² EZ Boss-Lock™ design

90° Type E Adapter x Hose Shank

Feature:

- pressure rating is based on the seal of the mating part, see ratings on page D-5

Size	356T6 Aluminum		316 Stainless Steel	
	Part #	Price/E	Part #	Price/E
2"	---	---	200E-90SS ¹	\$504.00
3"	300E-90AL	\$143.00	300E-90SS	564.00
4"	400E-90AL	169.50	400E-90SS ¹	882.00

¹ parts are produced as a welded fabrication



Cam & Groove

90° Type F Adapter x Male NPT

Feature:

- pressure rating is based on the seal of the mating part, see ratings on page D-5

Size	356T6 Aluminum		316 Stainless Steel	
	Part #	Price/E	Part #	Price/E
1½"	150F-90AL	\$60.00	---	---
2"	200F90AL	92.00	200F-90SS ¹	\$430.00
3"	---	---	300F-90SS ¹	765.00

¹ parts are produced as a welded fabrication



Cam & Groove

Dixon® Adapter x 150# Flange

Features:

- aluminum and unplated iron flanges are flat faced
- stainless steel flanges are raised face
- reference dixonvalve.com for flange bolt hole drilling circle standards
- flanges are designed to mate with 150# flange
- flanges have the same bolt hole pattern as an ANSI 150 lb. flange, the thickness may vary



Size	356T6 Aluminum		Flange Thick.	Unplated Malleable Iron		Flange Thick.	316 Stainless Steel		Flange Thick.
	Part #	Price/E		Part #	Price/E		Part #	Price/E	
1"	---	---	---	---	---	---	100-AL-SS	\$209.00	9/16"
1½"	---	---	---	---	---	---	150-AL-SS	197.70	11/16"
2"	200-AL-AL	\$115.00	¾"	---	---	---	200-AL-SS	229.70	7/16"
3"	300-AL-AL	121.50	5/8"	300-AL-MI	\$203.70	5/8"	300-AL-SS	299.00	7/16"
4"	400-AL-AL	164.00	5/8"	---	---	---	400-AL-SS	495.00	7/16"
6"	600-AL-AL	275.00	5/8"	---	---	---	600-AL-SS	750.00	5/8"
8"	800-AL-AL ¹	1400.00	1 1/8"	---	---	---	---	---	---

- ¹ part is produced as a welded fabrication
- For flange dimensions, diagrams and additional information please reference dixonvalve.com.

Dixon® Coupler x 150# Flange

Feature:

- Buna-N gasket standard, other gaskets available on pages D-48 to D-50



Size	356T6 Aluminum		Flange Thick	316 Stainless Steel		Flange Thick.
	Part #	Price/E		Part #	Price/E	
1"	---	---	---	100-DL-SS	\$196.10	21/32"
1½"	---	---	---	150-DL-SS	260.80	25/32"
2"	200-DL-AL	\$160.00	3/4"	200-DL-SS	385.00	7/16"
3"	300-DL-AL	222.00	15/16"	300-DL-SS	499.00	7/16"
4"	400-DL-AL	324.00	15/16"	400-DL-SS	985.00	7/16"
6"	600-DL-AL	419.00	1"	600-DL-SS	1124.00	5/8"
8"	800-DL-AL ¹	1800.00	1-1/8"	---	---	---

- ¹ part is produced as a welded fabrication
- For flange dimensions, diagrams and additional information please reference dixonvalve.com.

Dixon® Adapter x 150# ANSI Flange

Feature:

- global product made to Dixon® specifications



Size	316 Stainless Steel		Flange Thick.
	Part #	Price/E	
2"	200-AL-SSANSI	\$229.70	¾"
3"	300-AL-SSANSI	409.10	15/16"

- For flange dimensions, diagrams and additional information please reference dixonvalve.com.

EZ Boss-Lock™ Coupler x 150# Flange

Feature:

- Buna-N gasket standard, other gaskets available on pages D-48 to D-50



Size	316 Stainless Steel		Flange Thickness
	Part #	Price/E	
1"	RDL100EZ ¹	\$401.00	9/16"
1½"	RDL150EZ ¹	605.00	11/16"
2"	RDL200EZ	425.00	7/16"
3"	RDL300EZ ¹	600.00	7/16"
4"	RDL400EZ ¹	765.00	7/16"
6"	RDL600EZ ¹	1683.00	1"

- ¹ parts are produced as a welded fabrication
- For flange dimensions, diagrams and additional information please reference dixonvalve.com.

Feature:

- not all configurations are stocked
- Boss-Lock™ versions are also available, consult Dixon® for pricing and availability
- CAD models are for reference only, consult Dixon® for specific dimensions
- final weld preparation, as with all weld fittings, is the responsibility of the welder



Dixon® Coupler Socket Weld to Schedule 40 Pipe

Size	Bore	356T6 Aluminum		316 Stainless Steel	
		Part #	Price/E	Part #	Price/E
¾"	1.065	---	---	75DWSPSS	\$152.00
1"	1.330	100DWSPAL	\$57.75	100DWSPSS	126.20
1½"	1.915	150DWSPAL	65.00	150DWSPSS	153.00
2"	2.390	200DWSPAL	74.25	200DWSPSS	168.75
3"	3.530	300DWSPAL	71.80	300DWSPSS	268.80
4"	4.530	400DWSPAL	98.00	400DWSPSS	351.00
5"	5.562	500DWSPAL	227.00	500DWSPSS	691.00
6"	6.655	600DWSPAL	236.90	600DWSPSS	772.50
8"	8.711	800DWSPAL ¹	990.90	---	---



¹ Dixon® and Boss-Lock™ cam & groove couplings *do not interchange in the 8" size*. The 8" Dixon® design has 4 cam arms.



Dixon® Coupler Butt Weld to Schedule 40 Pipe/Socket Weld to Nominal Tubing

Size	Bore	356T6 Aluminum		316 Stainless Steel	
		Part #	Price/E	Part #	Price/E
¾"	.765	---	---	75DWPSTSS	\$125.90
1"	1.015	---	---	100DWPSTSS	126.20
1½"	1.515	150DWPSTAL	\$81.25	150DWPSTSS	153.00
2"	2.015	200DWPSTAL	57.70	200DWPSTSS	173.00
3"	3.015	300DWPSTAL	71.80	300DWPSTSS	268.80
4"	4.015	400DWPSTAL	93.90	400DWPSTSS	378.00
5"	5.015	500DWPSTAL	172.00	---	---
6"	6.020	600DWPSTAL	236.90	---	---



EZ Boss-Lock™ Coupler Socket Weld to Schedule 40 Pipe

Size	Bore	316 Stainless Steel	
		Part #	Price/E
¾"	1.065	RDWSP075EZ	\$214.25
1"	1.330	RDWSP100EZ	199.80
1½"	1.915	RDWSP150EZ	208.00
2"	2.390	RDWSP200EZ	215.30
3"	3.530	RDWSP300EZ	299.00
4"	4.530	RDWSP400EZ	356.00
6"	6.655	RDWSP600EZ	695.75



EZ Boss-Lock™ Coupler Butt Weld to Schedule 40 Pipe/Socket Weld to Nominal Tubing

Cam & Groove



Size	Bore	316 Stainless Steel	
		Part #	Price/E
¾"	.765	RDWBPST075EZ	\$153.40
1"	1.015	RDWBPST100EZ	159.65
1½"	1.515	RDWBPST150EZ	221.45
2"	2.015	RDWBPST200EZ	227.00
3"	3.015	RDWBPST300EZ	307.00
4"	4.015	RDWBPST400EZ	380.00
6"	6.020	RDWBPST600EZ	554.00

Adapter Socket Weld to Schedule 40 Pipe

Feature:



- not all configurations are stocked
- final weld preparation, as with all weld fittings, is the responsibility of the welder



Size	Bore	356T6 Aluminum		316 Stainless Steel	
		Part #	Price/E	Part #	Price/E
¾"	1.065	---	---	75AWSPSS	\$104.20
1"	1.330	---	---	100AWSPSS	97.95
1½"	1.915	150AWSPAL	\$127.40	150AWSPSS	117.00
2"	2.390	200AWSPAL	46.35	200AWSPSS	110.00
3"	3.530	300AWSPAL	58.60	300AWSPSS	196.35
4"	4.530	400AWSPAL	80.00	400AWSPSS	298.00
5"	5.593	500AWSPAL	123.75	500AWSPSS	450.00
6"	6.655	600AWSPAL	135.00	600AWSPSS	474.00
8" DIX	8.711	800AWSPAL ¹	474.00	---	---
8" BL	8.711	801AWSPAL ¹	453.00	---	---

Adapter Butt Weld to Schedule 40 Pipe/Socket Weld to Nominal Tubing



Size	Bore	356T6 Aluminum		316 Stainless Steel	
		Part #	Price/E	Part #	Price/E
¾"	.765	---	---	75AWBPSTSS	\$104.20
1"	1.015	---	---	100AWBPSTSS	97.95
1½"	1.515	150AWBPSTAL	\$60.00	150AWBPSTSS	117.00
2"	2.015	200AWBPSTAL	39.15	200AWBPSTSS	110.00
3"	3.015	300AWBPSTAL	58.60	300AWBPSTSS	196.35
4"	4.015	400AWBPSTAL	80.00	400AWBPSTSS	298.00
5"	5.015	500AWBPSTAL	123.75	500AWBPSTSS	450.00
6"	6.020	600AWBPSTAL	142.00	600AWBPSTSS	474.00
8" BL	8.035	801AWBPSTAL ¹	440.00	---	---



¹ Dixon® and Boss-Lock™ cam & groove couplings do not interchange in the 8" size.

Boss-Lock™ Coupler x Tube with 45° Cut

NEW

Cam & Groove

Application:

- for use on trailer relief valves

Features:

- butt weld to tubing
- brass Boss-Lock™ cam arms



Size	Part #	356T6Aluminum	Price/E
2"	AC200TUBE		\$89.00

In-Line Sight Glasses

Application:

- designed for dry bulk transfer hose

Feature:

- not intended for liquid service, for dry bulk transfer *only*



Materials:

- body: aluminum
- seals: Buna
- sight glass: acrylic
- hardware: stainless steel
- cam arms (where applicable): bronze



Coupler x Adapter

Size	Part #	Aluminum	Price/E
3" x 3"	3533CA		\$329.65
3" x 4"	3534CA		329.65
4" x 3"	3543CA		329.65
4" x 4"	3544CA		329.65



Adapter x Adapter

Size	Part #	Aluminum	Price/E
3" x 3"	3533AA		\$244.85
3" x 4"	3534AA		311.25
4" x 4"	3544AA		311.25



Coupler x Coupler

Size	Part #	Aluminum	Price/E
3" x 3"	3533CC		\$410.80
4" x 3"	3543CC		410.80
4" x 4"	3544CC		410.80



Adapter x Female NPSM



Application:

- used in the delivery of dry goods

Features:

- cork buna gaskets are standard in threaded end
- pressure rating is based on the seal of the mating part, see ratings on page D-5
- replacement gasket; **400GAGFI, \$4.30**

Size	356T6 Aluminum	
	Part #	Price/E
4"	400-AS-AL	\$88.00

Boss-Lock™ Coupler x Female NPSM

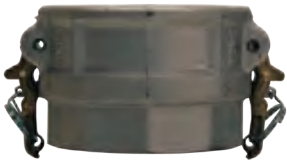

Feature:

- Buna-N gasket standard, other gaskets available on pages D-48 to D-50

Size	356T6 Aluminum	
	Part #	Price/E
4"	ADS400	\$97.65

Coupler x Adapter Wye



Size	356T6 Aluminum	
	Part #	Price/E
2"	200YDAAAL	\$142.00

Dixon® Cam & Groove Handles

Features:

- stainless steel pins standard with all assemblies
- roll pins are 302 stainless, solid pins are 303 stainless
- pull rings are standard on sizes 1¼" thru 6", optional on other sizes
- Domestic Dixon® standard handle assemblies are to only be used with standard Dixon® parts (not global), handles do not interchange with other manufacturer's handles or couplers. 

Coupler Size	Description	Brass		316 Sintered Stainless Steel	
		Part #	Price/E	Part #	Price/E
½"	cam arm and pin	---	---	50-HP-SP	\$4.50
¾"	cam arm and pin	---	---	75-HP-SP	4.15
1"	cam arm and pin	---	---	100-HP-SP	5.10
1¼" - 2½"	cam arm, ring and pin	200-HRP-BR	\$8.90	200-HRP-SP	6.85
3" - 5"	cam arm, ring and pin	300-HRP-BR	9.65	300-HRP-SP	8.20
6"	cam arm, ring and pin	600-HRP-BR	38.65	---	---
8"	cam arm and pin	800-HNP-BR	69.50	---	---



brass



316 sintered stainless steel



316 investment stainless steel

Coupler Size	Description	316 Investment Stainless Steel	
		Part #	Price/E
2"	cam arm, ring and pin	200-HSCRPI-SI	\$12.00
3"	cam arm, ring and pin	300-HSCRPI-SI	15.50
6"	cam arm, ring and pin	600-HRP-SI	57.70

Cam & Groove

Locking Handles for Dixon® Cam & Groove Dust Caps

Features:

- Dixon® locking handles are only to be used with standard Dixon® parts (not global). Handles do not interchange with other manufacturer's handles or couplers. 
- not supplied with pins

Coupler Size	Hole Diameter	Brass		316 Investment Stainless Steel	
		Part #	Price/E	Part #	Price/E
2"	9/32"	200-LH-BR	\$19.50	200-LH-SI	\$18.00
3"	5/16"	300-LH-BR	21.00	300-LH-SI	19.00
4"	¾"	400-LH-BR	25.75	400-LH-SI	22.00



200-LH-SI



300-LH-BR

Boss-Lock™ Cam & Groove Handles

Feature:

- Boss-Lock™ handles should only be used with Boss-Lock™ parts. Handles do not interchange with other manufacturer's handles or couplers. 

Coupler Size	Brass		316 Investment Stainless Steel		Plated Iron	
	Part #	Price/E	Part #	Price/E	Part #	Price/E
¾" - 1"	BHSC175	\$12.85	RHSC175	\$15.95	---	---
1¼" - 2½"	BHSC152	12.75	RHSC152	19.40	IHSC152	\$11.00
3" and 4"	BHSC34	14.90	RHSC34	29.00	IHSC34	14.80



Coupler Size	Brass		Plated Iron	
	Part #	Price/E	Part #	Price/E
6" and 8"	BH6	\$42.60	IH6	\$34.00



EZ Boss-Lock™ Handles

Cam & Groove



Features:

- investment cast stainless steel cam arm and lever
- 316 stainless steel spring
- stainless steel pin, washer, plated carbon steel pull ring

Coupler Size	Brass	
	Part #	Price/E
¾" - 1"	RHEZ175	\$21.40
1¼" - 2½"	RHEZ152	24.70
3" - 5"	RHEZ34	38.50
6" and 8"	RHEZ6	62.40

*Under no circumstances should the EZ Boss-Lock™ cam arms be used on any fitting not specifically produced for their use. The aluminum, brass and iron are made from sand castings. To ensure proper functioning of the EZ Boss-Lock™ cam arm assemblies, we sort the castings to ensure there is sufficient length and orientation on the lugs on the main casting to engage the lever. We also buff or grind the rougher sand cast surface to ensure that the lever will move freely. **The EZ Boss-Lock™ cam arms cannot be retrofitted onto existing aluminum, brass or plated iron Boss-Lock™ already in service.***



Paddle Handles for Dixon® Couplings



316 investment cast stainless steel



brass

Features:

- Dixon® paddle handles are only to be used with standard Dixon® parts (not global). Handles do not interchange with other manufacturer's handles or couplers.
- not supplied with pins



Coupler Size	Brass		316 Investment Cast Stainless Steel	
	Part #	Price/E	Part #	Price/E
3" and 4"	300H-PADBR	\$34.50	300H-PADSS	\$29.75

Dixon® Cam & Groove Gasket Dimensions

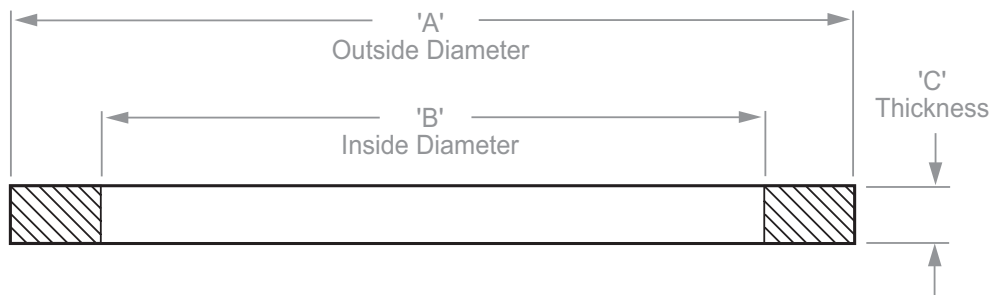

- nominal dimensions for Dixon® elastomeric cam & groove gaskets are listed
- ID's of the PTFE envelope gaskets and the PTFE accordion gaskets are 1/16" smaller than the ID's for the elastomeric gaskets shown below
- thickness of PTFE accordion gaskets may vary from chart below

Size	Part #	Dimensions		
		A	B	C
1/2"	50-G ¹	1-1/32"	11/16"	.156"
3/4"	75-G	1-3/8"	7/8"	.218"
1"	100-G	1-9/16"	1-1/16"	.250"
1 1/4"	125-G	1-15/16"	1-23/64"	.250"
1 1/2"	150-G	2-3/16"	1-5/8"	.250"
2"	200-G	2-5/8"	2"	.250"
2 1/2"	250-G	3-1/8"	2-3/8"	.250"
3"	300-G	3-23/32"	3"	.250"
4"	400-G	4-7/8"	4"	.250"
5"	500-G	5-15/16"	4-7/8"	.250"
6"	600-G	7-1/16"	6"	.250"
8"	800-G ¹	9-5/16"	8-1/8"	.343"

¹ No interchange standard exists for the 1/2" and 8" fittings. Generally, these sizes do not interchange with other manufacturer's products. As such, the gaskets in these sizes are not suitable for use in other manufacturers' couplings.



Dixon® Cam & Groove Gasket Color Codes

Gasket Code ¹	Material	Color	Color code stripes (appear on the OD of the gasket or filler)
-BU	Buna-N (standard in all metal fittings)	black	1 blue
-BF	Buna (formulated for fuel service)	black	1 green
-VI	FKM	black	1 yellow
-THK	Extra Thick Buna	black	2 blue
-EPR	Ethylene Propylene	black	1 white
-NE	Neoprene	black	1 red
-WNE	White Neoprene, FDA approved material	white	none
-WB	White Buna-N, FDA approved material	white	blue
-SIL	Silicone	red	none
-TF	PTFE (TFE) envelope with Buna-N filler	white / black	1 blue
TFVI	PTFE (TFE) envelope with FKM filler	white / black	1 yellow
TFWB	PTFE (TFE) envelope with White Buna-N filler, FDA approved materials	white / white	blue
TFEP	PTFE (TFE) envelope with Ethylene Propylene filler	white / black	1 white stripe
-TES	PTFE (FEP) encapsulated Silicone core, FDA approved materials	translucent / red	none
-TEV	PTFE (FEP) encapsulated FKM core	translucent / black	none
TFACC	PTFE (TFE) accordion, FDA approved materials	white	none

¹ part number suffix

Since other manufacturer's coding systems vary, this chart should not be used as a reference in identifying gaskets of unknown origin.



Cam & Groove Gaskets

Cam & Groove



Buna-N



FKM



extra thick Buna-N



ethylene propylene



neoprene



white neoprene



white Buna-N



silicone

Size	Buna-N		FKM	
	Part #	Price/E	Part #	Price/E
1/2"	50-G-BU	\$1.20	50-G-VI	\$4.90
3/4"	75-G-BU	1.20	75-G-VI	6.20
1"	100-G-BU	1.20	100-G-VI	8.75
1 1/4"	125-G-BU	1.20	125-G-VI	12.50
1 1/2"	150-G-BU	1.35	150-G-VI	12.30
2"	200-G-BU	1.20	200-G-VI	16.90
2 1/2"	250-G-BU	1.50	250-G-VI	20.90
3"	300-G-BU	1.55	300-G-VI	20.80
4"	400-G-BU	2.05	400-G-VI	34.80
5"	500-G-BU	3.75	500-G-VI	76.40
6"	600-G-BU	5.15	600-G-VI	71.50
8"	800-G-BU	22.50	800-G-VI	119.00

Size	extra thick Buna-N		Ethylene Propylene	
	Part #	Price/E	Part #	Price/E
3/4"	---	---	75-G-EPR	\$2.05
1"	100GTHK	\$1.75	100-G-EPR	2.05
1 1/4"	125GTHK	2.25	125-G-EPR	2.30
1 1/2"	150GTHK	2.25	150-G-EPR	2.25
2"	200GTHK	2.30	200-G-EPR	2.50
2 1/2"	250GTHK	3.00	250-G-EPR	2.70
3"	300GTHK	2.60	300-G-EPR	2.65
4"	400GTHK	3.40	400-G-EPR	3.60

Size	Neoprene		white Neoprene ¹	
	Part #	Price/E	Part #	Price/E
3/4"	75-G-NE	\$2.20	---	---
1"	100-G-NE	2.20	---	---
1 1/4"	125-G-NE	2.25	---	---
1 1/2"	150-G-NE	2.30	150-G-WNE	\$4.50
2"	200-G-NE	2.50	200-G-WNE	6.70
2 1/2"	250-G-NE	3.25	---	---
3"	300-G-NE	3.80	300-G-WNE	9.00
4"	400-G-NE	4.65	400-G-WNE	9.35
5"	---	---	500-G-WNE	18.80
6"	---	---	600-G-WNE	15.25

¹ white neoprene gaskets contain FDA approved materials

Size	white Buna-N ¹		Silicone	
	Part #	Price/E	Part #	Price/E
1 1/2"	---	---	150-G-SIL	\$3.80
2"	---	---	200-G-SIL	4.15
3"	300-G-WB	\$8.95	300-G-SIL	9.00
4"	400-G-WB	9.20	400-G-SIL	9.95

¹ white Buna-N gaskets contain FDA approved materials

Fuel Gaskets

Size	Part #	Material	Price
1½"	150-G-BF	<i>Buna</i>	\$2.00
2"	200-G-BF	<i>Buna</i>	2.40
3"	300-G-BF	<i>Buna</i>	2.70
4"	400-G-BF	<i>Buna</i>	3.90
3"	300GTHKBF	<i>extra thick Buna-N</i>	4.80
4"	400GTHKBF	<i>extra thick Buna-N</i>	6.35



Cam & Groove

Cam & Groove Envelope Gaskets

Features:

- PTFE white Buna filler (TFWB) contains FDA approved materials
- maximum operating temperatures for specific chemicals may be lower, contact Dixon® for specific recommendations

Size	<i>PTFE (TFE) with Buna-N filler</i>		<i>PTFE (TFE) with FKM filler</i>	
	Part #	Price/E	Part #	Price/E
½"	50-G-TF	\$7.70	50-G-TF-VI	\$10.75
¾"	75-G-TF	8.75	75-G-TF-VI	19.00
1"	100-G-TF	9.40	100GTFVI	20.00
1¼"	125-G-TF	11.00	125GTFVI	29.20
1½"	150-G-TF	13.00	150GTFVI	24.00
2"	200-G-TF	14.80	200GTFVI	29.60
2½"	250-G-TF	26.00	250GTFVI	48.00
3"	300-G-TF	19.25	300GTFVI	41.50
4"	400-G-TF	31.00	400GTFVI	65.40
6"	600-G-TF	75.40	600GTFVI	120.00



envelope

Size	<i>PTFE (TFE) with white Buna-N filler</i>		<i>PTFE (TFE) with Ethylene Propylene filler</i>	
	Part #	Price/E	Part #	Price/E
1½"	---	---	150GTFEP	\$15.50
2"	200GTFWB	\$15.90	200GTFEP	16.50
3"	300GTFWB	22.00	300GTFEP	20.40
4"	400GTFWB	40.75	---	---
5"	500GTFWB	73.00	---	---

The torque (force) required to close the handles on a pair of cam and groove fittings will vary according to the gasket chosen. Due to the nature of the PTFE material, the various PTFE gasket designs will require the most torque, increasing as you go from envelope to encapsulated, and finally, accordion.

Cam & Groove Encapsulated Gaskets

Features:

- *PTFE encapsulated silicone* (TES) gaskets contain FDA approved materials
- encapsulated gasket pressure ratings are reduced to **125 PSI** for ¾" - 4" at ambient temperature **70°F (21°C)**
- *PTFE encapsulated FKM* (TEV) gaskets - maximum operating temperature **200°F (93°C)**
- *PTFE encapsulated silicone* (TES) gaskets - maximum operating temperature **225°F (107°C)**
- maximum operating temperatures for specific chemicals may be lower, contact Dixon® for specific recommendations



Size	<i>PTFE (FEP) encapsulated silicone</i>		<i>PTFE (FEP) encapsulated FKM</i>	
	Part #	Price/E	Part #	Price/E
¾"	75-G-TES	\$33.00	75-G-TEV	\$50.00
1"	100-G-TES	33.00	100-G-TEV	49.60
1¼"	125-G-TES	37.75	125-G-TEV	55.00
1½"	150-G-TES	38.30	150-G-TEV	59.00
2"	200-G-TES	40.00	200-G-TEV	60.60
2½"	250-G-TES	48.20	250-G-TEV	79.60
3"	300-G-TES	55.00	300-G-TEV	83.50
4"	400-G-TES	74.00	400-G-TEV	121.00

Cam & Groove Accordion Gaskets

Features:

- *PTFE* accordion gaskets (TFACC) are recommended for use with viscous (thick) fluids only 
- maximum operating temperatures for specific chemicals may be lower, contact Dixon® for specific recommendations



Size	<i>PTFE (TFE)</i>	
	Part #	Price/E
¾"	75GTFACC	\$14.80
1"	100GTFACC	16.00
1¼"	125GTFACC	20.90
1½"	150GTFACC	19.00
2"	200GTFACC	22.00
3"	300GTFACC	48.00

The torque (force) required to close the handles on a pair of cam & groove fittings will vary according to the gasket chosen. Due to the nature of the PTFE material, the various PTFE gasket designs will require the most torque, increasing as you go from envelope to encapsulated, and finally, accordion.

Witches Hat Strainers

Features:

- used with female cam and groove couplings
- pre-attached Buna-N gasket

Size	304 Stainless Steel	
	Part #	Price/E
3"	WH300-A	\$36.25
4"	WH400-A	44.70



Cam & Groove

Gaskets for Witches Hat Strainers

Size	Buna-N Gasket	
	Part #	Price/E
3"	WH300-G	\$9.50
4"	WH400-G	10.50



Disk Strainers

Features:

- threads into bottom of female NPT fitting to protect equipment from large contaminants

Size	Hole Size	6061T6 Aluminum		304 Investment Cast Stainless Steel	
		Part #	Price/E	Part #	Price/E
2"	¼"	SDA200	\$21.00	SDS200	\$29.00
3"	¼"	SDA300	24.00	SDS300	40.00
4"	¼"	SDA400	37.80	SDS400	61.50

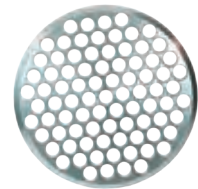

Pull Ring Safety Clips for Boss-Lock™

Coupler Size	Carbon Steel		316 Stainless Steel	
	Part #	Price/E	Part #	Price/E
¾" - 1"	---	---	100PRSCSS	\$2.50
1¼" - 2½"	200PRSCCS	\$2.10	200PRSCSS	3.00
3" and 4"	300PRSCCS	2.10	300PRSCSS	3.00



Pull Rings

304 Stainless Steel	
Part #	Price/E
R200SS	\$1.60



Sash Chain with Pull Rings

Feature:

- brass chain, plated steel pull ring

Length	Part #	Price/E
4½"	J125	\$10.60
6½"	J150	8.95
8½"	J300	12.00
12¾"	J500	16.90



Cam & Groove

Clip for Boss-Lock™ Couplings

Feature:

- .072 stainless steel wire



<i>Stainless Steel</i>	
Part #	Price/E
AC7	\$2.25

Clip Assembly

Features:

- for use with Boss-Lock™ couplings
- includes pull ring, chain and AC3 clip



<i>Carbon Steel</i>	
Part #	Price/E
BLCA152CS	\$9.50

Jack Chain with S-Hook

Length	Material	Part #	Price/E	Optional Qty
6"	<i>brass</i>	CH-B-6	\$8.25	10
12"	<i>brass</i>	CH-B-12	9.25	10
24"	<i>brass</i>	CH-B-24	18.90	---
12"	<i>carbon steel</i>	CH-C-12	7.90	10
6"	<i>stainless</i>	CH-SS-6	9.50	10
12"	<i>stainless</i>	CH-SS-12	11.95	10
24"	<i>stainless</i>	CH-SS-24	18.60	10

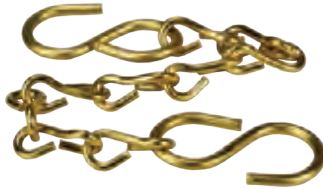

Locking Cam Arm Velcro® Straps

Applications:

- use with cam & groove couplers to prevent spills, secure from damage, and hold in place during transport

Feature:

- used on the female end of a cam & groove coupler
- high visibility orange hook and loop with metal buckle provides strength, durability and long life
- temperature range: **-70°F to 200°F (-57°C to 93°C)**



coupler sold separately

Length	Used On	Part #	Price/E
12"	fits up to 1½" coupler	CVS12	\$9.25
18"	fits up to 3" coupler	CVS18	10.00
24"	fits up to 5" coupler	CVS24	11.25
36"	fits up to 8" coupler	CVS36	12.00

Lanyards with Clip for Boss-Lock™ Couplings

Cam & Groove

Materials:

- clip: carbon steel
- lanyard: nylon

Coupler Size	Part #	Price/E
¾" - 1"	ACL4	\$3.30
1¼" - 4"	ACL2	3.15
6"	ACL3	6.50



PVC Coated Lanyards

Feature:

- one end factory crimped, one end uncrimped for field installation

Materials:

- PVC coated carbon steel with aluminum crimp sleeves

Length	Part #	Price/E
15"	CAL15	\$7.00
25"	CAL25	8.45



Lanyard for Boss-Lock™ Couplings

Feature:

- breaking strength: 160 lbs.

Overall Length	304 Stainless	
	Part #	Price/E
7"	LR7	\$8.00



Global Type A Adapter x Female NPT

Cam & Groove

Features:

- interchanges with all products produced to A-A-59326D
- Buna seals standard
- pressure rating for adapters is based on the seal of the mating part



ASTMC38000 forged brass

Size	A380 Permanent Mold Aluminum		ASTMC38000 Forged Brass	
	Part #	Price/E	Part #	Price/E
½"	G50-A-AL ¹	\$6.35	G50-A-BR ¹	\$11.80
¾"	G75-A-AL	5.00	G75-A-BR	10.70
1"	G100-A-AL	5.10	G100-A-BR	13.70
1¼"	G125-A-AL	7.75	G125-A-BR	17.70
1½"	G150-A-AL	5.70	G150-A-BR	20.45
2"	G200-A-AL	6.05	G200-A-BR	26.70
2½"	G250-A-AL	14.60	G250-A-BR	41.05
3"	G300-A-AL	12.40	G300-A-BR	47.05
4"	G400-A-AL	19.55	G400-A-BR	82.80
5"	G500-A-AL ¹	73.60	G500-A-BR ¹	197.30
6"	G600-A-AL	51.40	---	---
8"	G800-A-AL ¹	238.55	---	---

Size	316 Investment Cast Stainless Steel	
	Part #	Price/E
½"	G50-A-SS	\$18.00
¾"	G75-A-SS	19.00
1"	G100-A-SS	18.60
1¼"	G125-A-SS	29.10
1½"	G150-A-SS	31.05
2"	G200-A-SS	37.45
2½"	G250-A-SS	72.30
3"	G300-A-SS	78.35
4"	G400-A-SS	138.35
6"	G600-A-SS	248.50

¹ Does not interchange in the ½", 5", and 8" sizes with Dixon® or Boss-Lock™ style cam & groove.

Global Type B Coupler x Male NPT

Features:

- interchanges with all products produced to A-A-59326D
- Buna seals standard

Size	A380 Permanent Mold A with Brass Handles		ASTMC38000 Forged Brass	
	Part #	Price/E	Part #	Price/E
½"	G50-B-AL ^{1,2}	\$16.20	G50-B-BR ¹	\$27.10
¾"	G75-B-AL ²	10.75	G75-B-BR	24.45
1"	G100-B-AL ²	11.95	G100-B-BR ²	26.35
1¼"	G125-B-AL	16.30	G125-B-BR	36.70
1½"	G150-B-AL	13.65	G150-B-BR	35.70
2"	G200-B-AL	14.25	G200-B-BR	41.90
2½"	G250-B-AL	26.00	G250-B-BR	63.35
3"	G300-B-AL	23.60	G300-B-BR	77.70
4"	G400-B-AL	33.35	G400-B-BR	108.85
5"	G500-B-AL ¹	97.05	G500-B-BR ¹	316.10
6"	G600-B-AL	92.70	---	---

¹ Does not interchange in the ½" and 5" sizes with Dixon® or Boss-Lock™ style cam & groove.

² supplied with stainless steel handles



A380 permanent mold aluminum

Size	316 Investment Cast Stainless Steel		A380 Permanent Mold Aluminum with Stainless Steel Handles	
	Part #	Price/E	Part #	Price/E
½"	G50-B-SS	\$29.50	---	---
¾"	G75-B-SS	31.45	---	---
1"	G100-B-SS	32.20	---	---
1¼"	G125-B-SS	52.45	---	---
1½"	G150-B-SS	52.10	G150-B-ALSI	\$13.65
2"	G200-B-SS	65.55	G200-B-ALSI	14.25
2½"	G250-B-SS	94.60	---	---
3"	G300-B-SS	109.35	G300-B-ALSI	23.60
4"	G400-B-SS	160.40	G400-B-ALSI	33.35
6"	G600-B-SS	429.75	---	---

Global Type C Coupler x Hose Shank

Cam & Groove



A380 permanent mold aluminum

Features:

- interchanges with all products produced to A-A-59326D
- Buna seals are standard

Size	A380 Permanent Mold Aluminum with Brass Handles		ASTMC38000 Forged Brass	
	Part #	Price/E	Part #	Price/E
1/2"	G50-C-AL ^{1,2}	\$13.15	G50-C-BR ^{1,2}	\$31.10
3/4"	G75-C-AL ²	10.70	G75-C-BR ²	20.40
1"	G100-C-AL ²	10.95	G100-C-BR ²	29.50
1 1/4"	G125-C-AL	15.50	G125-C-BR	30.25
1 1/2"	G150-C-AL	13.20	G150-C-BR	39.60
2"	G200-C-AL	15.25	G200-C-BR	48.05
2 1/2"	G250-C-AL	25.90	G250-C-BR	70.45
3"	G300-C-AL	23.55	G300-C-BR	90.95
4"	G400-C-AL	36.75	G400-C-BR	132.00
5"	G500-C-AL ¹	103.00	G500-C-BR ¹	409.20
6"	G600-C-AL	109.20	---	---
8"	G800-C-AL ¹	335.00	---	---

¹ Does not interchange in the 1/2", 5", and 8" sizes with Dixon™ or Boss-Lock™ style cam & groove.

² supplied with stainless steel handles

Size	316 Investment Cast Stainless Steel		A380 Permanent Mold Aluminum with Stainless Steel Handles	
	Part #	Price/E	Part #	Price/E
1/2"	G50-C-SS	\$28.75	---	---
3/4"	G75-C-SS	30.40	---	---
1"	G100-C-SS	29.50	---	---
1 1/4"	G125-C-SS	50.35	---	---
1 1/2"	G150-C-SS	49.80	G150-C-ALSI	\$13.20
2"	G200-C-SS	63.65	G200-C-ALSI	15.25
2 1/2"	G250-C-SS	86.00	---	---
3"	G300-C-SS	125.45	G300-C-ALSI	23.55
4"	G400-C-SS	173.95	G400-C-ALSI	36.75
6"	G600-C-SS	406.15	---	---

- see page C-40 for Global Crimp Type C couplers

Global Type D Coupler x Female NPT

Features:

- interchanges with all products produced to A-A-59326D
- Buna seals are standard

Size	A380 Permanent Mold Aluminum with Brass Handles		ASTMC38000 Forged Brass	
	Part #	Price/E	Part #	Price/E
½"	G50-D-AL ^{1,2}	\$16.35	G50-D-BR ^{1,2}	\$29.90
¾"	G75-D-AL ²	12.10	G75-D-BR ²	22.75
1"	G100-D-AL ²	11.60	G100-D-BR ²	30.25
1¼"	G125-D-AL	16.95	G125-D-BR	35.15
1½"	G150-D-AL	12.90	G150-D-BR	39.20
2"	G200-D-AL	15.05	G200-D-BR	45.35
2½"	G250-D-AL	26.45	G250-D-BR	77.30
3"	G300-D-AL	25.15	G300-D-BR	80.95
4"	G400-D-AL	34.00	G400-D-BR	129.45
5"	G500-D-AL ¹	92.25	G500-D-BR ¹	310.90
6"	G600-D-AL	98.45	---	---

¹ does not interchange in the ½" and 5" sizes with Dixon® or Boss-Lock™ style cam & groove
² stainless steel handles



316 investment cast stainless steel

Size	316 Investment Cast Stainless Steel		A380 Permanent Mold Aluminum with Stainless Steel Handles	
	Part #	Price/E	Part #	Price/E
½"	G50-D-SS	\$29.75	---	---
¾"	G75-D-SS	31.35	---	---
1"	G100-D-SS	31.35	---	---
1¼"	G125-D-SS	52.90	---	---
1½"	G150-D-SS	54.70	G150-D-ALSI	\$12.90
2"	G200-D-SS	65.60	G200-D-ALSI	15.05
2½"	G250-D-SS	88.45	---	---
3"	G300-D-SS	107.45	G300-D-ALSI	25.15
4"	G400-D-SS	169.95	G400-D-ALSI	34.00
6"	G600-D-SS	421.00	---	---

Global Type E Adapter x Hose Shank

Cam & Groove



A380 permanent mold aluminum

Features:

- interchanges with all products produced to A-A-59326D
- Buna seals are standard
- pressure rating for adapters is based on the seal of the mating part

Size	A380 Permanent Mold Aluminum		ASTMC38000 Forged Brass		316 Investment Cast Stainless Steel	
	Part #	Price/E	Part #	Price/E	Part #	Price/E
1/2"	G50-E-AL ¹	\$8.80	G50-E-BR ¹	\$19.20	G50-E-SS	\$15.90
3/4"	G75-E-AL	4.35	G75-E-BR	19.70	G75-E-SS	16.75
1"	G100-E-AL	5.05	G100-E-BR	19.05	G100-E-SS	22.45
1 1/4"	G125-E-AL	7.55	G125-E-BR	21.35	G125-E-SS	36.10
1 1/2"	G150-E-AL	6.55	G150-E-BR	27.40	G150-E-SS	36.25
2"	G200-E-AL	8.40	G200-E-BR	38.25	G200-E-SS	50.45
2 1/2"	G250-E-AL	16.20	G250-E-BR	63.25	G250-E-SS	83.15
3"	G300-E-AL	15.15	G300-E-BR	76.75	G300-E-SS	110.25
4"	G400-E-AL	25.10	G400-E-BR	123.00	G400-E-SS	161.00
5"	G500-E-AL ¹	78.05	G500-E-BR ¹	447.95	---	---
6"	G600-E-AL	79.45	---	---	G600-E-SS	360.30
8"	G800-E-AL ¹	240.00	---	---	---	---

¹ does not interchange in the 1/2", 5", and 8" sizes with Dixon® or Boss-Lock™ style cam & groove

Global Type F Adapter x Male NPT

Features:

- interchanges with all products produced to A-A-59326D
- Buna seals are standard
- pressure rating for adapters is based on the seal of the mating part



ASTMC38000 forged brass

Size	A380 Permanent Mold Aluminum		ASTMC38000 Forged Brass		316 Investment Cast Stainless Steel	
	Part #	Price/E	Part #	Price/E	Part #	Price/E
1/2"	G50-F-AL ¹	\$6.60	G50-F-BR ¹	\$14.70	G50-F-SS	\$22.00
3/4"	G75-F-AL	5.35	G75-F-BR	13.30	G75-F-SS	23.30
1"	G100-F-AL	5.70	G100-F-BR	16.55	G100-F-SS	25.55
1 1/4"	G125-F-AL	9.40	G125-F-BR	29.65	G125-F-SS	41.20
1 1/2"	G150-F-AL	6.80	G150-F-BR	29.75	G150-F-SS	44.75
2"	G200-F-AL	7.65	G200-F-BR	34.60	G200-F-SS	53.80
2 1/2"	G250-F-AL	17.85	G250-F-BR	44.50	G250-F-SS	92.25
3"	G300-F-AL	16.85	G300-F-BR	67.55	G300-F-SS	112.05
4"	G400-F-AL	24.80	G400-F-BR	99.50	G400-F-SS	159.80
5"	G500-F-AL ¹	88.60	G500-F-BR ¹	332.10	---	---
6"	G600-F-AL	64.60	---	---	G600-F-SS	385.45

¹ does not interchange in the 1/2" and 5" sizes with Dixon® or Boss-Lock™ style cam & groove

Global Type DC Dust Caps

Features:

- interchanges with all products produced to A-A-59326D
- Buna seals are standard
- *Dust caps and dust plugs are not to be used in pressure applications for safety and environmental reasons*



Size	A380 Permanent Mold Aluminum with Brass Handles		ASTMC38000 Forged Brass	
	Part #	Price/E	Part #	Price/E
1/2"	G50-DC-AL ^{1,2}	\$14.40	G50-DC-BR ^{1,2}	\$24.05
3/4"	G75-DC-AL ²	10.60	G75-DC-BR ²	18.10
1"	G100-DC-AL ²	10.40	G100-DC-BR ²	22.30
1 1/4"	G125-DC-AL	14.00	G125-DC-BR	31.25
1 1/2"	G150-DC-AL	12.70	G150-DC-BR	34.95
2"	G200-DC-AL	12.40	G200-DC-BR	38.25
2 1/2"	G250-DC-AL	20.70	G250-DC-BR	44.90
3"	G300-DC-AL	23.10	G300-DC-BR	69.90
4"	G400-DC-AL	29.25	G400-DC-BR	97.05
5"	G500-DC-AL ¹	80.00	G500-DC-BR ¹	304.90
6"	G600-DC-AL	84.35	---	---



A380 permanent mold aluminum

¹ does not interchange in the 1/2" and 5" sizes with Dixon® or Boss-Lock™ style cam & groove use same arms as 3" and 4"

² stainless steel handles

Size	316 Investment Cast Stainless Steel		A380 Permanent Mold Aluminum with Stainless Steel Handles	
	Part #	Price/E	Part #	Price/E
1/2"	G50-DC-SS	\$27.00	---	---
3/4"	G75-DC-SS	28.45	---	---
1"	G100-DC-SS	28.80	---	---
1 1/4"	G125-DC-SS	50.50	---	---
1 1/2"	G150-DC-SS	48.35	G150-DC-ALSI	\$12.70
2"	G200-DC-SS	56.90	G200-DC-ALSI	12.40
2 1/2"	G250-DC-SS	78.45	---	---
3"	G300-DC-SS	93.60	G300-DC-ALSI	23.10
4"	G400-DC-SS	126.05	G400-DC-ALSI	29.25
6"	G600-DC-SS	405.95	---	---

Global Type DP Dust Plugs

Size	A380 Permanent Mold Aluminum		ASTMC38000 Forged Brass		316 Investment Cast Stainless Steel	
	Part #	Price/E	Part #	Price/E	Part #	Price/E
1/2"	G50-DP-AL ¹	\$5.05	G50-DP-BR ¹	\$18.65	G50-DP-SS	\$14.75
3/4"	G75-DP-AL	4.85	G75-DP-BR	12.80	G75-DP-SS	15.85
1"	G100-DP-AL	4.75	G100-DP-BR	14.20	G100-DP-SS	18.85
1 1/4"	G125-DP-AL	5.65	G125-DP-BR	18.75	G125-DP-SS	31.00
1 1/2"	G150-DP-AL	5.45	G150-DP-BR	17.85	G150-DP-SS	29.15
2"	G200-DP-AL	6.55	G200-DP-BR	21.20	G200-DP-SS	33.55
2 1/2"	G250-DP-AL	9.70	G250-DP-BR	34.60	G250-DP-SS	60.10
3"	G300-DP-AL	11.05	G300-DP-BR	37.40	G300-DP-SS	72.85
4"	G400-DP-AL	17.50	G400-DP-BR	62.15	G400-DP-SS	86.85
5"	G500-DP-AL ¹	48.20	G500-DP-BR ¹	201.45	---	---
6"	G600-DP-AL	44.90	---	---	G600-DP-SS	249.95



A380 permanent mold aluminum

¹ does not interchange in the 1/2" and 5" sizes with Dixon® or Boss-Lock™ style cam & groove

Global Jump Size Type DA Coupler x Adapter

Cam & Groove



A380 permanent mold aluminum

Features:

- interchanges with all products produced to A-A-59326D
- Buna seals standard
- pressure rating for adapters is based on the seal of the mating part

Size	A380 Permanent Mold Aluminum		316 Investment Cast Stainless Steel	
	Part #	Price/E	Part #	Price/E
2" x 3"	G2030-DA-AL	\$55.65	---	---
3" x 2"	G3020-DA-AL	58.05	G3020-DA-SS	\$195.50
3" x 4"	G3040-DA-AL	75.00	---	---
4" x 3"	G4030-DA-AL	83.70	G4030-DA-SS	321.00
5" x 4"	G5040-DA-AL	123.60	---	---
6" X 4"	G6040-DA-AL	144.40	---	---

Global Type AA Spool Adapters



A380 permanent mold aluminum

Size	A380 Permanent Mold Aluminum		316 Investment Cast Stainless Steel	
	Part #	Price/E	Part #	Price/E
1"	G100-AA-AL	\$8.55	---	---
1½"	G150-AA-AL	25.00	G150-AA-SS	\$75.50
2"	G200-AA-AL	21.60	G200-AA-SS	105.60
3"	G300-AA-AL	50.40	G300-AA-SS	183.35
4"	G400-AA-AL	65.80	G400-AA-SS	224.70



A380 permanent mold aluminum

Size	A380 Permanent Mold Aluminum		316 Investment Cast Stainless Steel	
	Part #	Price/E	Part #	Price/E
1½" x 2"	G1520-AA-AL	\$32.40	---	---
2" x 3"	G2030-AA-AL	49.75	G2030-AA-SS	\$137.40
3" x 4"	G3040-AA-AL	71.10	---	---

Global Type DD Spool Couplers



A380 permanent mold aluminum

Size	A380 Permanent Mold Aluminum		316 Investment Cast Stainless Steel	
	Part #	Price/E	Part #	Price/E
2"	G200-DD-AL	\$53.95	G200-DD-SS	\$129.55
3"	G300-DD-AL	75.45	G300-DD-SS	193.50
4"	G400-DD-AL	103.85	G400-DD-SS	375.00

Global Adapter x TTMA Flange

Features:

- interchange with all products produced to A-A-59326D
- Buna seals are standard
- pressure rating for adapters is based on the seal of the mating part



Size	356T6 Aluminum	
	Part #	Price/E
4"	G400-ALT-AL	\$62.00

Size	356T6 Aluminum	
	Part #	Price/E
4"	G400-DLT-AL	\$130.00

- For flange dimensions, diagrams and additional information please reference dixonvalve.com.

Global Jump Size Type A Adapter x Female NPT

Cam & Groove

Size	A380 Permanent Mold Aluminum	
	Part #	Price/E
3" x 2"	G3020-A-AL	\$42.30
4" x 3"	G4030-A-AL	52.30



Global Jump Size Type C Coupler x Hose Shank

Size	A380 Permanent Mold Aluminum	
	Part #	Price/E
3" x 2"	G3020-C-AL	\$52.95
4" x 3"	G4030-C-AL	68.20



Global Jump Size Type E Adapter x Hose Shank

Size	A380 Permanent Mold Aluminum	
	Part #	Price/E
3" x 2"	G3020-E-AL	\$27.85
4" x 3"	G4030-E-AL	57.30



- see page C-40 for Global Crimp Type E adapters

Global Handles for Aluminum / Brass Couplers

Cam & Groove



Feature:

- supplied complete with ring and pin

Fits on sizes	Investment Stainless	
	Part #	Price/E
3/4"	G75HRP	\$2.70
1"	G100HRP	4.05
1 1/2" & 2"	G152HRPSI	4.60
3" - 5"	G34HRPSI	7.10
6"	G600HRPSI	20.45



Fits on sizes	Forged Brass	
	Part #	Price/E
1 1/4" - 2 1/2"	G152HRP	\$5.50
3" - 5"	G34HRP	8.10
6" and 8"	G600HRP	21.50

Global Handles for Stainless Couplers



Fits on sizes	Investment Stainless	
	Part #	Price/E
3/4"	G75HRPSS	\$4.15
1"	G100HRPSS	4.00
1 1/4" - 2 1/2"	G125250HRPSS	9.35
3" - 5"	G300400HRPSS	9.35
6"	G600HRPSS	20.25

- Global Dixon handle assemblies are to only be used with global Dixon parts (not domestic). Handles do not interchange with other manufacturer's handles or couplers.



Global Safety Clip



Zinc Plated Carbon Steel		Bag Qty
Part #	Price/E	
GSAFETYCLIP	\$0.40	25

Swivel Adapters

Features:

- powder coated aluminum swivel nut
- for suction and low pressure discharge only

Type A x Female NST (NH)

Size Adapter	Female NST (NH) Thread	Aluminum	
		Part #	Price
1½"	1½"	G150-A-ALNST	\$80.00
2½"	2½"	G250-A-ALNST	103.75
3"	2½"	3025-A-ALNST	116.75

**Type B x Male NST (NH)**

Coupler Size	Male NST (NH) Thread	Aluminum	
		Part #	Price
1½"	1½"	G150-B-ALNST	\$123.05
2"	1½"	2015-B-ALNST	112.65
2½"	2½"	G250-B-ALNST	138.80
3"	2½"	3025-B-ALNST	155.80

**Type D x Female NST (NH)**

Coupler Size	Female NST (NH) Thread	Aluminum	
		Part #	Price
1½"	1½"	G150-D-ALNST	\$90.40
2"	2½"	2025-D-ALNST	110.10
2½"	2½"	G250-D-ALNST	116.75
3"	2½"	3025-D-ALNST	136.40

**Type F x Male NST (NH)****Feature:**

- other sizes, configurations and materials available, contact Dixon® for information

Adapter Size	Male NST (NH) Thread	Aluminum	
		Part #	Price
1½"	1½"	G150-F-ALNST	\$127.00
2"	2½"	2025-F-ALNST	139.95
2½"	2½"	G250-F-ALNST	125.80
3"	2½"	3025-F-ALNST	143.70



Cam & Groove

Type A Adapter x Female NPT

Features:

- maximum operating pressure: **125 PSI** (½" - 1"), **100 PSI** (1¼" - 2"), **60 PSI** (3") and **50 PSI** (4"); recommendations based on the use of mating Dixon® fittings at an ambient temperature of **70°F (21°C)** with standard seal installed
- ½" couplers and adapters will interchange with ¾" couplers and adapters, only the threads and barbs are ½"
- 1¼" couplers and adapters will interchange with 1½" couplers and adapters, only the threads and barbs are 1¼"
- polypropylene cam & groove should not be mixed with metal fittings
- NOT recommended for use with PTFE gaskets. NOT recommended for use with PTFE gaskets. Polypropylene cam & groove should not be mixed with metal fittings. 



Size	Glass-Filled Polypropylene		Optional Qty
	Part #	Price/E	
¾" x ½"	PPA50	\$2.45	24
¾"	PPA75	2.45	24
1"	PPA100	2.50	24
1½" x 1¼"	PPA125	3.90	24
1½"	PPA150	4.05	24
2"	PPA200	5.10	24
3"	PPA300	8.55	24
4"	PPA400	21.00	8

90° Adapter x Female NPT

Features:

- maximum operating pressure: **100 PSI** (1½" - 2"); recommendations based on the use of mating Dixon® fittings at an ambient temperature of **70°F (21°C)** with standard seal installed
- for use at elevated temperatures or other unusual operating conditions, consult Dixon®
- NOT recommended for use with PTFE gaskets. NOT recommended for use with PTFE gaskets. Polypropylene cam & groove should not be mixed with metal fittings. 



Size	Glass-Filled Polypropylene		Optional Qty
	Part #	Price/E	
1½"	90PPA150	\$9.50	24
2"	90PPA200	10.50	24

Type B Coupler x Male NPT

Features:

- supplied with EPDM gaskets, 304 stainless steel handles and pins
- maximum operating pressure: **125 PSI** (½" - 1"), **100 PSI** (1¼" - 2"), **60 PSI** (3") and **50 PSI** (4"); recommendations based on the use of mating Dixon® fittings at an ambient temperature of **70°F (21°C)** with standard seal installed
- ½" couplers and adapters will interchange with ¾" couplers and adapters, only the threads and barbs are ½"
- 1¼" couplers and adapters will interchange with 1½" couplers and adapters, only the threads and barbs are 1¼"
- replacements: gasket use EPR on page D-48, key rings use **R200SS** on page D-51, safety clip use **GSAFETYCLIP** on page D-62
- NOT recommended for use with PTFE gaskets. Polypropylene cam & groove should not be mixed with metal fittings. 



Size	Glass-Filled Polypropylene		Optional Qty
	Part #	Price/E	
¾" x ½"	PPB50	\$6.80	24
¾"	PPB75	6.80	24
1"	PPB100	8.35	24
1½" x 1¼"	PPB125	12.40	24
1½"	PPB150	14.00	24
2"	PPB200	15.80	24
3"	PPB300	23.95	24
4"	PPB400¹	38.95	8

¹ 4" coupler has 4 handles

Type C Coupler x Hose Shank

Features:

- manufactured from a glass-filled polypropylene
- supplied with EPDM gaskets, 304 stainless steel handles and pins
- maximum operating pressure: **125 PSI** (½" - 1"), **100 PSI** (1¼" - 2"), **60 PSI** (3") and **50 PSI** (4"); recommendations based on the use of mating Dixon® fittings at an ambient temperature of **70°F (21°C)** with standard seal installed
- ½" couplers and adapters will interchange with ¾" couplers and adapters, only the threads and barbs are ½"
- 1¼" couplers and adapters will interchange with 1½" couplers and adapters, only the threads and barbs are 1¼"
- replacements: gasket use **EPR** on page D-48, pull rings use **R200SS** on page D-51, safety clip use **GSAFETYCLIP** on page D-62
- NOT recommended for use with PTFE gaskets. Polypropylene cam and groove should not be mixed with metal fittings. 



Size	Glass-Filled Polypropylene		Optional Qty
	Part #	Price/E	
¾" x ½"	PPC50	\$7.00	24
	PPC75	7.00	24
	PPC100	8.50	24
1½" x 1¼"	PPC125	13.00	24
	PPC150	14.40	24
	PPC200	16.65	24
	PPC300	25.15	24
	PPC400 ¹	42.20	8

¹ 4" coupler has 4 handles

90° Coupler x Hose Shank

Features:

- supplied with EPDM gaskets, 304 stainless steel handles and pins
- maximum operating pressure: **100 PSI** (1½" - 2"); recommendations based on the use of mating Dixon® fittings at an ambient temperature of **70°F (21°C)** with standard seal installed
- for use at elevated temperatures or other unusual operating conditions, consult Dixon® 
- NOT recommended for use with PTFE gaskets. Polypropylene cam and groove should not be mixed with metal fittings.



Size	Glass-Filled Polypropylene		Optional Qty
	Part #	Price/E	
1½"	90PPC150	\$21.80	24
2"	90PPC200	24.10	24

Type D Coupler x Female NPT

Features:

- supplied with EPDM gaskets, 304 stainless steel handles and pins
- polypropylene cam & groove should not be mixed with metal fittings
- maximum operating pressure: **125 PSI** (½" - 1"), **100 PSI** (1¼" - 2"), **60 PSI** (3") and **50 PSI** (4"); recommendations based on the use of mating Dixon® fittings at an ambient temperature of **70°F (21°C)** with standard seal installed
- ½" couplers and adapters will interchange with ¾" couplers and adapters, only the threads and bars are ½"
- 1¼" couplers and adapters will interchange with 1½" couplers and adapters, only the threads and bars are 1¼"
- replacements: gasket use EPR on page D-48, pull rings use **R200SS** on page D-51, safety clip use **GSAFETYCLIP** on page D-62
- NOT recommended for use with PTFE gaskets. Polypropylene cam and groove should not be mixed with metal fittings. 



Size	Glass-Filled Polypropylene		Optional Qty
	Part #	Price/E	
¾" x ½"	PPD50	\$8.25	24
	PPD75	8.25	24
	PPD100	9.20	24
1½" x 1¼"	PPD125	14.40	24
	PPD150	15.10	24
2"	PPD200	16.90	24
3"	PPD300	25.35	24
4"	PPD400¹	41.20	8

¹ 4" coupler has 4 handles

Polypropylene 90° Coupler x Female NPT

Features:

- supplied with EPDM gaskets, 304 stainless steel handles and pins
- maximum operating pressure: **100 PSI** (1½" - 2"); recommendations based on the use of mating Dixon® fittings at an ambient temperature of **70°F (21°C)** with standard seal installed
- for use at elevated temperatures or other unusual operating conditions, consult Dixon®
- NOT recommended for use with PTFE gaskets. Polypropylene cam and groove should not be mixed with metal fittings. 



Size	Glass-Filled Polypropylene		Optional Qty
	Part #	Price/E	
1½"	90PPD150	\$21.00	24
2"	90PPD200	25.00	24

Type E Adapter x Hose Shank

Features:

- maximum operating pressure: **125 PSI** (½" - 1"), **100 PSI** (1¼" - 2"), **60 PSI** (3") and **50 PSI** (4"); recommendations based on the use of mating Dixon® fittings at an ambient temperature of **70°F (21°C)** with standard seal installed
- ½" couplers and adapters will interchange with ¾" couplers and adapters, only the threads and barbs are ½"
- 1¼" couplers and adapters will interchange with 1½" couplers and adapters, only the threads and barbs are 1¼"
- NOT recommended for use with PTFE gaskets. Polypropylene cam & groove should not be mixed with metal fittings. 



Size	Glass-Filled Polypropylene		Optional Qty
	Part #	Price/E	
¾" x ½"	PPE50	\$1.65	24
	PPE75	1.65	24
1"	PPE100	2.05	24
1½" x 1¼"	PPE125	3.05	24
	PPE150	4.20	24
2"	PPE200	5.60	24
3"	PPE300	9.80	24
4"	PPE400	18.60	8

Type F Adapter x Male NPT

Features:

- maximum operating pressure: **125 PSI** (½" - 1"), **100 PSI** (1¼" - 2"), **60 PSI** (3") and **50 PSI** (4"); recommendations based on the use of mating Dixon® fittings at an ambient temperature of **70°F (21°C)** with standard seal installed
- ½" couplers and adapters will interchange with ¾" couplers and adapters, only the threads and barbs are ½"
- 1¼" couplers and adapters will interchange with 1½" couplers and adapters, only the threads and barbs are 1¼"
- NOT recommended for use with PTFE gaskets. Polypropylene cam & groove should not be mixed with metal fittings. 



Size	Glass-Filled Polypropylene		Optional Qty
	Part #	Price/E	
¾" x ½"	PPF50	\$1.80	24
	PPF75	1.80	24
1"	PPF100	2.05	24
1½" x 1¼"	PPF125	3.15	24
	PPF150	4.05	24
2"	PPF200	5.40	24
3"	PPF300	12.05	24
4"	PPF400	21.85	8

90° Adapter x Male NPT

Features:

- maximum operating pressure: **100 PSI** (1½" - 2"); recommendations based on the use of mating Dixon® fittings at an ambient temperature of **70°F (21°C)** with standard seal installed
- for use at elevated temperatures or other unusual operating conditions, consult Dixon® 
- NOT recommended for use with PTFE gaskets. Polypropylene cam & groove should not be mixed with metal fittings.



Size	Glass-Filled Polypropylene		Optional Qty
	Part #	Price/E	
1½"	90PPF150	\$7.00	24
2"	90PPF200	8.55	24

Dust Caps and Plugs

Features:

- 1¼" couplers and adapters will interchange with 1½" couplers and adapters, only the threads and barbs are 1¼"
- Dust caps and dust plugs are not to be used in pressure applications for safety and environmental reasons.
- NOT recommended for use with PTFE gaskets. Polypropylene cam & groove should not be mixed with metal fittings



Type H Dust Caps



Size	Polypropylene		Optional Qty
	Part #	Price/E	
¾"	PPH75	\$6.65	24
1"	PPH100	8.10	24
1½"	PPH150	13.40	24
2"	PPH200	14.70	24
3"	PPH300	21.40	24
4"	PPH400¹	35.30	8

¹ 4" coupler has 4 handles

Type P Dust Plugs



Size	Glass-Filled Polypropylene		Optional Qty
	Part #	Price/E	
¾"	PPP75	\$1.40	24
1"	PPP100	1.65	24
1½"	PPP150	3.30	24
2"	PPP200	4.40	24
3"	PPP300	6.55	24
4"	PPP400	12.85	8

King™ Combination Nipples E-2 to E-6	Garden Hose Ftgs. (cont.) .. E-39 to E-50
NPT threaded.....E-2	Compression bibb faucet.....E-48
Beveled end.....E-3	Quick connect.....E-48
Grooved end.....E-3	Valves.....E-49
Global NPT threaded.....E-4	Y.....E-49
Jump size.....E-4	Manifold.....E-50
150# ASA flange.....E-4	Back flow preventer.....E-50
Turned back.....E-5	Radiator bibb.....E-50
BSPT end.....E-5	Gooseneck.....E-50
For Plastic pipe.....E-5	
PF shank.....E-6	Plastic Barbs & Inserts ... E-51 to E-57
External swage notched.....E-6	Tuff-Lite™.....E-51 to E-57
King Nipple..... E-7	Agri-Lock Style Couplings E-58 to E-61
	Type A.....E-58 to E-61
Shank Couplings E-8 to E-15	Bauer Style Couplings E-62 to E-66
Suction couplings.....E-8 to E-9	Type B.....E-62 to E-66
Short shank.....E-10	
Spanner wrenches.....E-11	Fire Hose Couplings..... E-67 to E-72
Long shank.....E-11 to E-13	Expansion ring couplings.....E-67 to E-68
Spray hose.....E-14	Hose type booster.....E-68
Gaskets.....E-15	Forestry couplings.....E-69 to E-70
	Expansion rings.....E-70
Strainers, Skimmers & Foot Valves E-16 to E-18	Washers.....E-71
Strainers.....E-16	Expansion ring and gasket guide.....E-72
Skimmers.....E-17	
Foot valves.....E-18	
Hose Barbs & Inserts E-19 to E-38	
Hose menders.....E-19 to E-20	
Male x hose barbs.....E-21 to E-22	
Female x hose barbs.....E-22 to E-23	
Elbows.....E-24 to E-26	
Splicers.....E-25	
SAE / JIC.....E-26 to E-27	
Push-on.....E-28 to E-35	
Reusable.....E-36 to E-38	
Garden Hose Fittings..... E-39 to E-50	
Standard shanks.....E-39, E-41	
Short shanks.....E-40 to E-41	
Menders.....E-40	
Long shank.....E-42	
Spray hose.....E-43	
GHT zinc.....E-44	
Adapters.....E-44 to E-46	
Washers.....E-47	
Caps.....E-47	
Nuts.....E-47	

King™ Combination Nipples - NPT Threaded

⚠ WARNING**Applications:**

- Recommended for low-pressure discharge and suction service for compatible liquids.
Sizes 1¼" and above are not for compressible products such as air or nitrogen.
- **King™ Combination Nipples are not recommended for steam.**
- *The working pressure may vary with the construction of the hose, the type of clamping system used and the application. Consult Dixon® for recommendations.*
- In accordance with the Association for Rubber Products Manufacturers (ARPM) bulletin for oil suction and discharge hose, a coupled length of hose in any size, should be tested to 1½ times the working pressure and held for fifteen minutes without leaking or coupling movement. For additional information and detailed instruction on testing procedures, see the Association for Rubber Products Manufacturers (ARPM) handbook.

NPT Threaded End with Knurled Wrench Grip



Size	Opt Qty	Unplated Steel		Plated Steel		Brass		Aluminum	
		Part #	Price/E	Part #	Price/E	Part #	Price/E	Part #	Price/E
½"	50	ST1	\$4.70	STC1	\$5.05	BST1	\$21.75	AST1	\$21.00
¾"	50	ST5	5.40	STC5	5.55	BST5	31.70	AST5	16.05
1"	50	ST10	6.95	STC10	7.30	BST10	32.25	AST10	19.05
1¼"	50	ST15	9.35	STC15	10.05	---	---	---	---
1½"	50	ST20	9.65	STC20	10.30	---	---	---	---
2"	25	ST25	11.95	STC25	12.60	---	---	---	---

- For additional information on pipe dimensions please reference dixonvalve.com.

NPT Threaded End No Knurl



Size	Opt Qty	Unplated Steel		Plated Steel		Brass		Aluminum	
		Part #	Price/E	Part #	Price/E	Part #	Price/E	Part #	Price/E
1¼"	50	---	---	---	---	BST15	\$35.40	AST15	\$18.00
1½"	50	---	---	---	---	BST20	44.75	AST20	18.25
2"	25	---	---	---	---	BST25	66.70	AST25	20.35
2½"	10	ST30	\$19.75	STC30	\$23.15	BST30	106.60	AST30	59.00
3"	10	ST35	23.55	STC35	28.45	BST35	148.60	AST35	47.00
4"	4	ST40	36.40	STC40	40.80	BST40	283.90	AST40	72.60
5"	4	ST50	84.10	STC50	89.25	---	---	AST50	164.85
6"	2	ST60	95.00	STC60	107.00	---	---	AST60	178.50
8"	2	ST80	167.00	STC80	202.80	---	---	---	---
10"	1	ST100	267.50	STC100	337.50	---	---	---	---
12"	1	ST120	429.30	STC120	490.00	---	---	---	---



Size	Opt Qty	316 Stainless Steel		Hastelloy®	
		Part #	Price/E	Part #	Price/E
½"	50	RST1 ¹	\$21.10	---	---
¾"	50	RST5 ¹	21.15	---	---
1"	50	RST10	21.25	---	---
1¼"	50	RST15	27.10	---	---
1½"	50	RST20	33.90	---	---
2"	25	RST25	45.00	HST25	\$780.00
2½"	10	RST30	82.75	---	---
3"	10	RST35	117.40	HST35	1450.00
4"	4	RST40	184.20	---	---
5"	4	RST50	405.00	---	---
6"	4	RST60	508.20	---	---
8"	2	RST80	975.00	---	---

¹ made from investment casting

- For additional information on pipe dimensions please reference dixonvalve.com.

King™ Combination Nipples - Beveled End

Feature:

- Beveled ends (in *brass* and *aluminum*) are available in select sizes. Consult Dixon® for prices and availability.

Hose ID	Unplated Steel		Pkg Qty	316 Stainless Steel		Pkg Qty	Aluminum	
	Part #	Price/E		Part #	Price/E		Part #	Price/E
1/2"	STB1	\$6.60	50	---	---	--	---	---
3/4"	STB5	8.40	50	RSTB5	\$27.50	50	---	---
1"	STB10	9.80	50	RSTB10	24.60	50	ASTB10	\$18.90
1 1/4"	STB15	11.25	50	RSTB15	38.55	50	ASTB15	22.60
1 1/2"	STB20	11.10	50	RSTB20	33.85	50	ASTB20	25.20
2"	STB25	12.65	25	RSTB25	52.90	25	ASTB25	34.50
2 1/2"	STB30	21.20	10	RSTB30	96.30	10	ASTB30	POR
3"	STB35	26.05	10	RSTB35	108.85	10	ASTB35	72.50
4"	STB40	37.90	4	RSTB40	181.30	4	ASTB40	83.20
5"	STB50	89.25	4	---	---	--	ASTB50	260.00
6"	STB60	95.60	2	RSTB60	492.50	--	ASTB60	195.00
8"	STB80	177.60	2	RSTB80	980.00	--	ASTB80	POR
10"	STB100	308.30	1	---	---	--	ASTB100	POR
12"	STB120	435.00	1	---	---	--	---	---



Industrial Hose Fittings

- For additional information on pipe dimensions please reference dixonvalve.com.

King™ Combination Nipples - Grooved End

Feature:

- Grooved ends (in *brass* and *aluminum*) are available in select sizes. Consult Dixon® for prices and availability.

Hose ID	Unplated Steel		Pkg Qty	316 Stainless Steel		Pkg Qty
	Part #	Price/E		Part #	Price/E	
1"	STV10	\$9.80	50	---	---	---
1 1/4"	STV15	13.80	50	---	---	---
1 1/2"	STV20	13.00	50	RSTV20	\$46.65	50
2"	STV25	12.65	25	RSTV25	50.50	25
2 1/2"	STV30	22.90	10	---	---	---
3"	STV35	25.80	10	RSTV35	144.20	10
4"	STV40	36.10	4	RSTV40	193.65	5
5"	STV50	82.85	4	---	---	---
6"	STV60	102.00	4	---	---	---
8"	STV80	179.25	2	---	---	---
10"	STV100	317.20	1	---	---	---
12"	STV120	455.40	1	---	---	---



- For additional information on pipe dimensions please reference dixonvalve.com.

Global King™ Combination Nipples - NPT Threaded



Features:

- Combination nipples are recommended for low-pressure discharge and suction service for compatible liquids. **Sizes 1¼" and above are not for compressible products such as air or nitrogen.**
- **Global King™ Combination Nipples are not recommended for steam.**
- *The working pressure may vary with the construction of the hose, the type of clamping system used and the application. Consult Dixon® for recommendations.*
- In accordance with the Association for Rubber Products Manufacturers (ARPM) bulletin for oil suction and discharge hose, a coupled length of hose in any size, should be tested to 1½ times the working pressure and held for fifteen minutes without leaking or coupling movement. For additional information and detailed instruction on testing procedures, see the Association for Rubber Products Manufacturers (ARPM) handbook.



Size	Plated Steel		Box Qty
	Part #	Price/E	
½"	GSTC1	\$2.40	100
¾"	GSTC5	2.65	100
1"	GSTC10	3.75	50
1¼"	GSTC15	4.90	50
1½"	GSTC20	5.75	50
2"	GSTC25	6.85	25
2½"	GSTC30	12.15	10
3"	GSTC35	13.40	10
4"	GSTC40	21.05	4
5"	GSTC50	54.50	4
6"	GSTC60	60.90	4

Jump Size King™ Combination Nipples - NPT Threaded

Hose Shank	Male NPT	Plated Steel		316 Stainless Steel	
		Part #	Price/E	Part #	Price/E
¾"	½"	---	---	RST0501	\$34.00
¾"	1"	STC0510	\$11.80	RST0510	44.85
1"	¾"	STC1005	8.40	RST1005	32.10
1"	1¼"	STC1015	17.30	RST1015	57.75
1¼"	1"	STC1510	11.00	RST1510	72.00
1¼"	1½"	STC1520	14.90	RST1520	78.00
1½"	1¼"	STC2015	12.25	RST2015	83.20
1½"	2"	STC2025	18.35	RST2025	97.10
1¾"	2"	STC175200	24.30	---	---
2"	1½"	STC2520	23.25	RST2520	96.15
2"	2½"	STC2530	36.90	---	---
2"	3"	STC2535	55.00	RST2535	122.60
2½"	2"	STC3025	32.95	---	---
2½"	3"	STC3035	40.40	---	---
3"	2"	STC3525	64.70	RST3525	143.85
3"	2½"	STC3530	44.40	---	---
3"	4"	STC3540	79.45	---	---
4"	3"	STC4035	88.20	---	---

• For additional information on pipe dimensions please reference dixonvalve.com.

150# ASA Flanged King™ Combination Nipples



Size	Steel		316 Stainless Steel	
	Part #	Price/E	Part #	Price/E
1½"	FST20	\$96.25	RFST20	\$250.00
2"	FST25	96.80	RFST25	296.40
3"	FST35	133.75	RFST35	431.00
4"	FST40	169.50	RFST40	573.00
6"	FST60	302.25	RFST60	967.50
8"	FST80	530.00	RFST80	1660.00
10"	FST100	787.95	RFST100	3502.00
12"	FST120	1210.25	RFST120	4630.00

• For flange dimensions, diagrams and additional information on pipe dimensions please reference dixonvalve.com.

King™ Turned Back Hose Nipples for Floating Flanges

Features:

- A turned back nipple, when used in a floating flange assembly, allows the flange to be aligned without stressing (twisting) the hose. This generally increases the hose's service life by eliminating a common cause of premature hose failure.
- for use with Lap Joint flanges shown on page J-36

Size	Plated Carbon Steel		316 Stainless Steel	
	Part #	Price/E	Part #	Price/E
1"	N10	\$50.30	RN10	\$119.40
1¼"	N15	49.80	RN15	148.30
1½"	N20	78.20	RN20	152.35
2"	N25	84.70	RN25	203.70
2½"	N30	113.30	RN30	381.20
3"	N35	98.15	RN35	311.50
4"	N40	156.50	RN40	466.00
6"	N60	254.00	RN60	916.70
8"	N80	375.00	RN80	1535.00
10"	N100	643.00	RN100	POR
12"	N120	1035.00	RN120	POR



Industrial Hose Fittings

- For additional information on pipe dimensions please reference dixonvalve.com.

Notched Turned Back Nipple Stems

Features:

- Stems are for use with lap joint flanges on page J-36.
- When used with an appropriate notched ferrule, these fittings can be swaged or crimped onto hose providing improved shank retention.
- When used with double bolt or band clamps, notched turn back nipples provide shank retention similar to that of the King™ turned back nipples.
- The stem can be removed from a damaged hose by cutting away the ferrule without necessarily damaging the fitting.

Special pushers required:
 1½" stem - RN150NOPUSH
 2" stem - RN200NOPUSH
 2½" stem - RN250NOPUSH
 3" stem - RN300NOPUSH
 4" stem - RN400NOPUSH

Size	Carbon Steel		316 Stainless Steel	
	Part #	Price/E	Part #	Price/E
1½"	N150NO	\$31.50	RN150NO	\$80.60
2"	N200NO	35.55	RN200NO	92.70
2½"	N250NO	55.00	RN250NO	125.00
3"	N300NO	84.25	RN300NO	162.00
4"	N400NO	141.10	RN400NO	248.25



- For additional information on pipe dimensions please reference dixonvalve.com.

King™ Combination Nipples - BSPT End

Features:

- Grooved and beveled ends (in brass and aluminum) are available in select sizes. Consult Dixon® for prices and availability.
- See pages J-38 to J-50 for our complete line of groove style fittings.

Size	Plated Steel		Optional Qty	316 Stainless Steel		Optional Qty
	Part #	Price/E		Part #	Price/E	
1"	STC10A	\$7.70	50	RST10A	\$23.00	50
1¼"	STC15A	10.70	50	RST15A	27.80	50
1½"	STC20A	11.65	50	RST20A	35.55	50
2"	STC25A	13.80	50	RST25A	45.00	25
2½"	STC30A	24.00	10	RST30A	82.00	10
3"	STC35A	27.40	10	RST35A	118.00	10
4"	STC40A	39.75	4	RST40A	183.00	4
6"	STC60A	109.85	2	RST60A	505.00	2



King™ Combination Nipples for Plastic Pipe

Size	Plated Steel		Optional Qty
	Part #	Price/E	
½"	SAP1	\$9.00	50
¾"	SAP6	14.65	50
1"	SAP11	13.90	50
1¼"	SAP16	15.30	50
1½"	SAP21	16.30	50
2"	SAP26	16.90	25



- For additional information on pipe dimensions please reference dixonvalve.com.



PF Shank King™ Combination Nipples - NPT Threaded

Application:

- This shank design was developed specifically for chemical transport hoses having Crosslinked Polyethylene (XLPE) or Ultra High Molecular Weight Polyethylene (UHMW) tubes, where shank retention can be a problem when using conventional band clamps.

Features:

- PF shank King™ Combination nipples have the same shank pattern as found on the PF style cam and groove fittings sold on page D-23.
- recommended for discharge and suction service
- **Not intended for compressed air**
- working pressure is given at **70°F (21°C)** maximum
- *The working pressure may vary with the construction of the hose, the type of clamping system used and the application. Consult Dixon® for recommendations.*

Size	Working PSI	Plated Steel		316 Stainless Steel	
		Part #	Price/E	Part #	Price/E
2"	250	ST25PF	\$37.80	RST25PF	\$67.15
3"	125	ST35PF	44.95	RST35PF	168.70
4"	100	ST40PF	64.10	RST40PF	175.00
6"	75	ST60PF	140.00	RST60PF	425.00

- Beveled ends for welding are also available. Contact Dixon® for further information.
- For additional information on pipe dimensions please reference dixonvalve.com.

External Swage Notched NOS Stems

⚠ WARNING

The notched system allows you to better manage your inventories. You can stock one stem and two ferrules, and cover the same hose range with less inventory. *You must purchase a fitting and the matching ferrule to create an assembly.*

Features:

- For hose outside diameters of 2-4/64" and below, *couplings are crimp only.*
- For hose outside diameters of 2-5/64" and above, couplings can be crimped or swaged.
- See page D-16 for cam and groove style notched NOS fittings and page F-22 for NOS ferrules.



Only use the NOS shank with the NOS ferrules. Due to differences in dimensions and tolerances for safety reasons, do not use other manufacturer's stems or ferrules with Dixon® Holedall™ products.



Size	PSI	316 Stainless Steel	
		Part #	Price/E
1½"	250	RST150NOS	\$45.40
2"	250	RST200NOS	54.00
3"	250	RST300NOS	119.60
4"	¹	RST400NOS	183.35

- ¹ Contact Dixon® for pressure information
- Tuff-Lite™ male inserts in nylon and polypropylene are on page D-51.

King™ Steel Round Nipples for 1 Clamp

Hose Size	NPT Size	Unplated Steel		Optional Qty
		Part #	Price/E	
5/8"	1/2"	KRN541	\$12.00	100
3/4"	1/2"	KRN641	9.70	50
1"	3/4"	KRN861	12.85	25

Industrial Hose
Fittings

King™ Steel Round Nipples for 2 Clamps

Hose Size	NPT Size	Unplated Steel		Optional Qty
		Part #	Price/E	
1/2"	1/4"	KRN422	\$17.45	100
	3/8"	KRN432	11.30	100
5/8"	1/2"	KRN542	18.70	100
3/4"	1/2"	KRN642	14.30	50
	3/4"	KRN662	18.00	50
1"	3/4"	KRN862	12.85	50
1"	1"	KRN882	19.60	50
1 1/4"	1"	KRN1082	13.70	25
1 1/2"	1 1/4"	KRN1210	18.90	25
2"	1 1/2"	KRN1612	48.15	20



King™ Steel Hex Nipples for 1 Clamp

Hose Size	NPT Size	Plated Steel		Optional Qty
		Part #	Price/E	
1/4"	1/4"	KHN221	\$12.65	50
3/8"	1/4"	KHN321	11.85	100
	3/8"	KHN331	11.00	100
	1/2"	KHN341	14.25	100
1/2"	1/4"	KHN421	13.80	50
	3/8"	KHN431	14.00	50
	1/2"	KHN441	10.80	50
3/4"	3/4"	KHN461	13.80	50
	1/2"	KHN641	16.15	50
	3/4"	KHN661	15.20	50
1"	3/4"	KHN861	18.90	25
	1"	KHN881	19.80	25



King™ Steel Hex Nipples for 2 Clamps

Hose Size	NPT Size	Plated Steel		Optional Qty
		Part #	Price/E	
1/4"	1/4"	KHN222	\$19.50	100
3/8"	1/4"	KHN322	16.75	100
	3/8"	KHN332	16.70	50
	1/2"	KHN342	21.00	100
1/2"	1/4"	KHN422	17.70	100
	3/8"	KHN432	15.85	100
	1/2"	KHN442	15.95	50
3/4"	3/4"	KHN462	21.00	50
	1/2"	KHN642	15.60	50
	3/4"	KHN662	15.05	50
1"	3/4"	KHN862	20.95	25
	1"	KHN882	23.30	25



King™ Short Shank Suction Couplings - NPSM Thread

Industrial Hose
Fittings

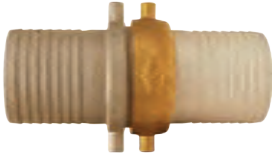

complete



female



1" - 2½"
male



3" - 6"
male

Size	Aluminum shank with Brass nut		Pkg Qty	Aluminum shank with Brass nut		Aluminum	
	Complete Part #	Price/E		Female Part #	Price/E	Male Part #	Price/E
1½"	CAB150	\$13.90	60	FAB150	\$9.45	MA150	\$4.15
2"	CAB200	20.50	40	FAB200	14.10	MA200	5.25
2½"	CAB250	37.30	30	FAB250	24.25	MA250	11.65
3"	CAB300	42.90	18	FAB300	27.00	MA300	13.85
4"	CAB400	85.00	8	FAB400	59.25	MA400	27.20
6"	CAB600	178.00	6	FAB600	118.00	MA600	52.00

Size	Brass shank with Brass nut		Brass shank with Brass nut		Brass	
	Complete Part #	Price/E	Female Part #	Price/E	Male Part #	Price/E
1¼"	CBB125	\$36.00	FBB125	\$20.50	MB125	\$19.20
1½"	CBB150	38.70	FBB150	24.10	MB150	18.10
2"	CBB200	55.00	FBB200	32.40	MB200	26.50
2½"	CBB250	88.70	FBB250	49.00	MB250	50.60
3"	CBB300	142.00	FBB300	84.70	MB300	67.75
4"	CBB400	250.00	FBB400	128.40	MB400	91.00

Size	Plated Iron shank with Plated Iron nut		Plated Iron shank with Plated Iron nut		Plated Iron	
	Complete Part #	Price/E	Female Part #	Price/E	Male Part #	Price/E
1"	S33 ¹	\$26.25	S12 ¹	\$15.60	S10	\$10.65
1¼"	S48	39.35	S17	22.65	S15	16.70
1½"	S63	38.60	S22	21.50	S20	17.10
2"	S78	52.90	S27	29.50	S25	23.40
2½"	S93	92.00	S32	55.00	S30	37.00
3"	S111	99.60	S38	49.90	S36	49.70
4"	S123	166.20	S42	90.50	S40	75.70
5"	S168	341.60	S57	222.50	S55	119.00
6"	S183	349.00	S62	203.65	S60	145.35

Size	Plated Iron shank with Brass nut		Plated Iron shank with Brass nut		Plated Iron	
	Complete Part #	Price/E	Female Part #	Price/E	Male Part #	Price/E
1"	SB33 ¹	\$32.65	SB12 ¹	\$22.00	S10	\$10.65
1¼"	SB48	35.90	SB17	19.20	S15	16.70
1½"	SB63	35.10	SB22	18.00	S20	17.10
2"	SB78	47.20	SB27	24.50	S25	23.40
2½"	SB93	82.40	SB32	46.35	S30	37.00
3"	SB111	95.35	SB38	46.65	S36	49.70
4"	SB123	155.60	SB42	81.40	S40	75.70
5"	SB168	326.85	SB57	207.85	S55	119.00
6"	SB183	333.70	SB62	188.35	S60	145.35

¹ 1" fittings have a hex nut design

- complete couplings supplied with rubber gaskets
- Replacement gaskets (KRW standard) are available, see page E-15.

Steel King™ Short Shank Suction Couplings - NPSM Thread

Size	Plated Steel shank with Plated Iron nut		Plated Steel shank with Plated Iron nut		Plated Steel	
	Complete Part #	Price/E	Female Part #	Price/E	Male Part #	Price/E
1¼"	CSM125	\$41.75	FCSM125	\$23.90	MCS125	\$17.85
1½"	CSM150	33.65	FCSM150	20.35	MCS150	13.30
2"	CSM200	47.70	FCSM200	27.60	MCS200	20.10
2½"	CSM250	62.55	FCSM250	33.10	MCS250	29.45
3"	CSM300	78.25	FCSM300	44.15	MCS300	34.10
4"	CSM400	132.85	FCSM400	85.00	MCS400	47.85
6"	CSM600	267.25	FCSM600	150.15	MCS600	117.10

Size	Plated Steel shank with Brass nut		Plated Steel shank with Brass nut		Plated Steel	
	Complete Part #	Price/E	Female Part #	Price/E	Male Part #	Price/E
1¼"	CSB125	\$45.15	FCSB125	\$27.30	MCS125	\$17.85
1½"	CSB150	32.90	FCSB150	19.60	MCS150	13.30
2"	CSB200	42.10	FCSB200	22.00	MCS200	20.10
2½"	CSB250	64.70	FCSB250	35.25	MCS250	29.45
3"	CSB300	75.75	FCSB300	42.50	MCS300	34.10
4"	CSB400	135.90	FCSB400	88.05	MCS400	47.85
6"	CSB600	259.85	FCSB600	142.75	MCS600	117.10



complete



female



male

Industrial Hose Fittings

- Replacement gaskets (KRW standard) are available, see page E-15.

King™ Short Shank Suction Couplings - NST (NH) Thread

Size	Aluminum shank with Brass nut		Aluminum shank with Brass nut		Aluminum	
	Complete Part #	Price/E	Female Part #	Price/E	Male Part #	Price/E
1½"	CAB150N	\$29.75	FAB150N	\$17.60	MA150N	\$9.00
2½"	CAB250N	57.50	FAB250N	33.50	MA250N	17.85

Size	Brass shank with Brass nut		Brass shank with Brass nut		Brass	
	Complete Part #	Price/E	Female Part #	Price/E	Male Part #	Price/E
1½"	BS63N	\$73.70	BS22N	\$27.45	BS201	\$46.25
2½"	BS93N	157.95	BS32N	65.75	BS301	92.20

Size	Plated Iron shank with Plated Iron nut		Plated Iron shank with Plated Iron nut		Plated Iron	
	Complete Part #	Price/E	Female Part #	Price/E	Male Part #	Price/E
1½"	S63N	\$51.35	S22N	\$29.20	S201	\$22.15
2½"	S93N	92.90	S32N	50.00	S301	42.90

Size	Plated Iron shank with Brass nut		Plated Iron shank with Brass nut		Plated Iron	
	Complete Part #	Price/E	Female Part #	Price/E	Male Part #	Price/E
1½"	SB63N	\$52.45	SB22N	\$30.30	S201	\$22.15
2½"	SB93N	108.40	SB32N	65.50	S301	42.90



complete



female



male

- NST (Common Fire Hose Thread) is also known as NH
- Replacement gaskets (KRW standard) are available, see page E-15.

Shank Suction Couplings

Feature:

- Standard gasket is rubber (KRW); for FKM gaskets (KVW) see page E-15

Industrial Hose
Fittings

Short Shank Complete Couplings

Size	316 Stainless Steel	
	Part #	Price/E
½"	RES404	\$98.90
¾"	RES606	62.35
1"	RES808	63.80
1¼"	RES48	166.40
1½"	RES63	131.60
2"	RES78	169.75

Short Shank Female Couplings - NPSM



Size	316 Stainless Steel	
	Part #	Price/E
½"	RES444	\$77.80
¾"	RES646	41.20
1"	RES848	42.55
1¼"	RES33	139.30
1½"	RES43	99.00
2"	RES53	124.75

Short Shank Complete Machined Couplings



Hose ID	NPSM Thread	Previous Part #	Brass	
			Part #	Price/E
½"	¾"	---	BS406	\$20.17
¾"	¾"	---	BS606	20.40
1"	1"	BS808 ¹	5921616K¹	26.85

¹ NPSH threads

Short Shank Machined Female Couplings with Swivel Nut



Hose ID	NPSM Thread	Previous Part #	Brass	
			Part #	Price/E
½"	¾"	---	BS446	\$9.75
⅝"	¾"	---	BS546	9.55
¾"	¾"	---	BS646	9.80
1"	1"	BS848 ¹	5911616C¹	13.14

¹ NPSH threads

Short Shank Machined Male Couplings



Hose ID	NPSM Thread	Previous Part #	Brass	
			Part #	Price/E
½"	¾"	---	BS416	\$10.64
¾"	¾"	---	BS616	9.72
1"	1"	BS818 ¹	5901616C¹	14.25

¹ NPSH threads

use with KRW washers on page E-15

Super King™ Long Shank Female Couplings - NPSM

Size	Shank Length	Plated Steel Shank with Brass Pin Lug Nut ¹		Plated Steel Shank with Iron Pin Lug Nut ¹	
		Part #	Price/E	Part #	Price/E
1¼"	4½"	SD15	\$44.75	SDMP15	\$44.35
1½"	4½"	SD20	47.20	SDMP20	46.10
2"	5"	SD25	58.35	SDMP25	57.20
2½"	5"	SD30	86.50	SDMP30	82.00
3"	5"	SD35	85.45	SDMP35	81.10
4"	5"	SD40	124.00	SDMP40	123.00



pin lug nut

Industrial Hose Fittings

Size	Shank Length	316 Stainless Shank with Iron Pin Lug Nut ¹		316 Stainless Shank with Stainless Hex Nut ²	
		Part #	Price/E	Part #	Price/E
1½"	4½"	---	---	RSHR20	\$126.00
2"	5"	RSDM25	\$116.00	RSDR25	157.00
3"	5"	RSDM35	158.00	---	---



hex nut

¹ K LW leather gaskets standard

² PTFE gaskets standard

Super King™ Long Shank Male Couplings - NPT

Size	Shank Length	Plated Steel		316 Stainless	
		Part #	Price/E	Part #	Price/E
1¼"	4-3/8"	SK16	\$20.00	---	---
1½"	4-5/32"	SK21	23.25	---	---
2"	5-5/16"	SK26	28.50	RSK26	\$80.00
2½"	5-5/16"	SK31	47.90	---	---
3"	5-1/2"	SK36	51.45	RSK36	148.00
4"	5-1/2"	SK46	72.30	---	---



- all Super King™ long shank couplings accept 3 band clamps
- replacement FKM (KVV) gaskets are available on page E-15
- PTFE gaskets are available on page A-34

Pin Lug Spanner Single End Wrenches

Size	Plated Iron	
	Part #	Price/E
2"	SW20	\$10.15
2½"	SW25	11.55
3"	SW30	13.25
4"	SW40	13.85
6"	SW60	84.85



Pin Lug Spanner Double End Wrench

Size	Plated Iron	
	Part #	Price/E
1½", 2" x 2½", 3"	SW153	\$25.50



- additional spanner wrenches are available on page J-116

Long Shank Complete Couplings - NPSM

Industrial Hose
Fittings



plated steel

Hose ID	NPSM Thread	Plated Steel		Plated Iron		Previous Part #	Brass	
		Part #	Price/E	Part #	Price/E		Part #	Price/E
1/2"	1/2"	SLS404	\$26.30	---	---	---	BLS404	\$25.60
1/2"	3/4"	---	---	---	---	---	BLS406	29.50
5/8"	3/4"	---	---	---	---	---	BLS506	25.00
3/4"	3/4"	SLS606	29.30	---	---	---	BLS606	24.25
1"	1"	SLS808	41.40	---	---	BLS808	5951616K¹	34.40
1 1/4"	1 1/4"	---	---	MLS48	\$54.05	---	BLS48	81.80
1 1/2"	1 1/2"	---	---	MLS63	57.85	---	BLS63	108.95
2"	2"	---	---	MLS78	80.00	---	BLS78	163.25

- sizes 1/2" to 1" are machined; 1 1/4" to 2" are cast

Long Shank Female Couplings - NPSM



plated steel

Hose ID	NPSM Thread	Plated Steel		Plated Iron		Previous Part #	Brass	
		Part #	Price/E	Part #	Price/E		Part #	Price/E
1/2"	1/2"	SLS444	\$13.80	---	---	---	BLS444	\$12.50
1/2"	3/4"	---	---	---	---	---	BLS446	12.75
5/8"	3/4"	---	---	---	---	---	BLS546	13.75
3/4"	3/4"	SLS646	15.10	---	---	---	BLS646	12.85
1"	1"	SLS848	22.15	---	---	BLS848	5941616C¹	16.36
1 1/4"	1 1/4"	---	---	MLS33	\$26.25	---	BLS33	45.80
1 1/2"	1 1/2"	---	---	MLS43	28.15	---	BLS43	59.75
2"	2"	---	---	MLS53	47.00	---	BLS53	89.75

- 1/2" to 1" are machined; 1 1/4" to 2" are cast

Long Shank Male Couplings - NPSM



plated steel

Hose ID	NPSM Thread	Plated Steel		Plated Iron		Previous Part #	Brass	
		Part #	Price/E	Part #	Price/E		Part #	Price/E
1/2"	1/2"	SLS414	\$12.50	---	---	---	BLS414	\$10.69
1/2"	3/4"	---	---	---	---	---	BLS416	13.35
5/8"	3/4"	---	---	---	---	---	BLS516	9.18
3/4"	3/4"	SLS616	14.20	---	---	---	BLS616	11.38
1"	1"	SLS818	19.25	---	---	BLS818	5931616C¹	18.75
1 1/4"	1 1/4"	---	---	MLS15	\$28.35	---	BLS15	36.00
1 1/2"	1 1/2"	---	---	MLS20	29.70	---	BLS20	49.20
2"	2"	---	---	MLS25	33.00	---	BLS25	73.50

- 1/2" to 1" are machined; 1 1/4" to 2" are cast

¹ NPSH thread

Long Shank Complete Couplings - NST

Hose ID	NST Thread	Brass	
		Part #	Price/E
1½"	1½"	BLS63NST	\$125.85
2½"	2½"	BLS93NST	228.75



- replacement gaskets (KRW standard) available on page E-15
- for GHT long shank complete couplings see page E-42

Long Shank Female Couplings - NST

Hose ID	NST Thread	Brass	
		Part #	Price/E
1½"	1½"	BLS150NST	\$72.25
2½"	2½"	BLS250NST	118.00



- replacement gaskets (KRW standard) available on page E-15
- for GHT long shank female coupling see page E-42

Long Shank Male Couplings - NST

Hose ID	NST Thread	Brass	
		Part #	Price/E
1½"	1½"	BLS20NST	\$53.60
2½"	2½"	BLS30NST	110.75



- replacement gaskets (KRW standard) available on page E-15
- for GHT long shank male coupling see page E-42



Spray Hose Complete Couplings - NPSM

Hose ID	NPSM Thread	Plated Steel	
		Part #	Price/E
3/8"	3/4"	SS306	\$30.45
1/2"	1/2"	SS404	37.50
1/2"	3/4"	SS406	30.30
3/4"	3/4"	SS606	38.60
1"	1"	SS808	69.05

- for GHT spray hose complete coupling see page E-43

Spray Hose Female Couplings - NPSM



Hose ID	NPSM Thread	Plated Steel	
		Part #	Price/E
3/8"	3/4"	SS346	\$14.60
1/2"	1/2"	SS444	23.50
1/2"	3/4"	SS446	13.00
3/4"	3/4"	SS646	23.60
1"	1"	SS848	47.55

- for GHT spray hose female coupling see page E-43

Spray Hose Male Couplings - NPSM



Hose ID	NPSM Thread	Plated Steel	
		Part #	Price/E
3/8"	3/4"	SS316	\$15.85
1/2"	1/2"	SS414	14.00
1/2"	3/4"	SS416	17.30
3/4"	3/4"	SS616	15.00
1"	1"	SS818	21.50

- for GHT spray hose male coupling see page E-43

Gaskets for Suction, Long and Short Shank Couplings

• for use on NPSM threaded couplings

Hose ID	Rubber (Styrene Butadiene)		Neoprene		FKM	
	Part #	Price/E	Part #	Price/E	Part #	Price/E
1/2"	KRW1	\$0.45	---	---	---	---
3/4"	KRW5	0.45	KNW5	\$0.50	---	---
1"	KRW10	0.45	KNW10	0.50	KVW10	\$3.85
1 1/4"	KRW15	0.45	KNW15	0.95	---	---
1 1/2"	KRW20	0.55	KNW20	0.75	KVW20	7.25
2"	KRW25	0.70	KNW25	0.85	KVW25	10.10
2 1/2"	KRW30	0.90	KNW30	0.95	---	---
3"	KRW35	0.90	KNW35	1.35	KVW35	21.85
4"	KRW40	1.50	KNW40	2.15	---	---
5"	KRW50	3.50	---	---	---	---
6"	KRW60	4.45	KNW60	6.35	---	---
8"	KRW80	9.80	KNW80	12.10	---	---



rubber



neoprene



FKM



leather



rubber

Hose ID	Leather		Rubber	
	Part #	Price/E	Part #	Price/E
1/2"	KLW1	\$2.95	---	---
3/4"	KLW5	1.75	---	---
1"	KLW10	2.20	---	---
1 1/4"	KLW15	2.05	---	---
1 1/2"	KLW20	2.60	KRW2075¹	\$1.85
2"	KLW25	4.45	---	---
2 1/2"	KLW30	2.60	KRW3075¹	1.90
3"	KLW35	4.40	---	---
4"	KLW40	5.20	---	---

¹ NST only threaded couplings

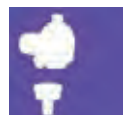



zinc plated steel



304 stainless steel

Round Hole Strainers

NPSM Size	Zinc Plated Steel		304 Stainless Steel	
	Part #	Price/E	Part #	Price/E
1½"	RHS20	\$26.00	RRHS20	\$230.00
2"	RHS25	26.00	RRHS25	286.25
2½"	RHS30	33.25	---	---
3"	RHS35	38.50	RRHS35	400.00
4"	RHS40	54.00	RRHS40	495.00
6"	RHS60	156.25	RRHS60	835.00
8"	RHS80	357.10	RRHS80	2710.95
10"	RHS100	655.00	---	---
12"	RHS120	1191.00	---	---

Square Hole Strainers



NPSM Size	Zinc Plated Steel	
	Part #	Price/E
2"	SHS25	\$26.00
3"	SHS35	38.50
4"	SHS40	54.00
6"	SHS60	156.25
8"	SHS80	357.10
10"	SHS100	655.00
12"	SHS120	1191.00

Long Thin Round Hole Strainers



NPSM Size	Zinc Plated Steel	
	Part #	Price/E
1½"	RSS20	\$22.90
2"	RSS25	24.20
3"	RSS35	36.70
4"	RSS40	50.20

Bottom Skimmers - Round Hole Type

NPSM Size	Zinc Plated Steel	
	Part #	Price/E
1½"	DSB20	\$68.00
2"	DSB25	76.00
3"	DSB35	169.50



Industrial Hose Fittings

Top Skimmers - Round Hole Type

NPSM Size	Zinc Plated Steel	
	Part #	Price/E
1½"	DST20	\$68.00
2"	DST25	76.00
3"	DST35	169.50



Suction Strainers

NPT Size	Black Polypropylene with 30% fiberglass	
	Part #	Price/E
1½"	TSS20	\$15.60
2"	TSS25	15.60
3"	TSS35	26.30
4"	TSS40 NEW	29.00



Threaded Foot Valves



- **must** be installed in the *vertical position*
- for water service *only*
- not for compressed air or other compressible gases

Industrial Hose
Fittings

NPT Size	Painted Cast Iron	
	Part #	Price/E
1½"	DFVS20	\$32.55
2"	DFVS25	52.85
2½"	DFVS30	61.10
3"	DFVS35	77.70
4"	DFVS40	142.00
6"	DFVS60	339.95
8"	DFVS80	706.15

Strainers



Size	Painted Cast Iron	
	Part #	Price/E
1½"	FVS20	\$6.90
2"	FVS25	10.60
2½"	FVS30	20.95
3"	FVS35	21.20
4"	FVS40	28.80
6"	FVS60	68.90
8"	FVS80	189.35

Flapper Assemblies



Size	Painted Cast Iron / Rubber	
	Part #	Price/E
1½"	FVFA20	\$14.80
2"	FVFA25	17.80
2½"	FVFA30	22.30
3"	FVFA35	23.80
4"	FVFA40	35.00
6"	FVFA60	85.90
8"	FVFA80	187.80

Valves



Size	Rubber	
	Part #	Price/E
1½"	FVL20	\$6.65
2"	FVL25	10.60
2½"	FVL30	13.00
3"	FVL35	19.65
4"	FVL40	30.75
6"	FVL60	65.75
8"	FVL80	124.05

Seat Plates



Size	Painted Cast Iron	
	Part #	Price/E
1½"	FVSP20	\$6.35
2"	FVSP25	5.30
2½"	FVSP30	9.55
3"	FVSP35	15.20
4"	FVSP40	16.70
6"	FVSP60	36.10
8"	FVSP80	67.75

Dixon® Hose Menders

- They are not for compressible products such as air, nitrogen or steam.
- The working pressure may vary with the construction of the hose, the type of clamping system used and the application. Consult Dixon® for recommendations.
- In accordance with the ARPM bulletin for oil suction and discharge hose, a coupled length of hose in any size, should be tested to 1½ times the working pressure and held for fifteen minutes without leaking or coupling movement. For additional information and detailed instruction on testing procedures, see the Association for Rubber Products Manufacturer's (ARPM) handbook or visit ARPMINC.com.



Size	Zinc Plated Steel		Optional Qty	316 Stainless Steel		Optional Qty
	Part #	Price/E		Part #	Price #	
¼"	DMA	\$7.65	200	RDMA	\$28.00	100
⅜"	DMB	7.80	100	RDMB	32.65	100
½"	DM1	7.75	50	RDM1	28.15	50
⅝"	DM5	7.95	50	---	---	---
¾"	DM6	7.15	50	RDM6	58.00	50
1"	DM11	6.85	50	RDM11	61.00	50
1¼"	DM16	9.25	50	RDM16	64.50	5
1⅜"	DM18	25.55	50	---	---	---
1½"	DM21	10.55	50	RDM21	73.50	50
1½"	DMXL21 ¹	24.15	25	---	---	---
2"	DM26	12.25	50	RDM26	82.70	10
2"	DMXL26 ¹	29.05	25	---	---	---
2½"	DM31	18.65	25	---	---	---
3"	DM36	22.50	20	RDM36	183.30	5
4"	DM46	41.40	10	RDM46	216.30	5
5"	DM51	130.00	5	---	---	---
6"	DM66	100.55	4	---	---	---
8"	DM86	218.00	1	---	---	---
10"	DM100	335.00	1	---	---	---
12"	DM120	512.30	1	---	---	---



zinc plated steel



316 stainless steel



¹ XL series has extra long shank

King™ Hose Menders

- They are not for compressible products such as air, nitrogen or steam.
- The working pressure may vary with the construction of the hose, the type of clamping system used and the application. Consult Dixon® for recommendations.
- In accordance with the ARPM bulletin for oil suction and discharge hose, a coupled length of hose in any size, should be tested to 1½ times the working pressure and held for fifteen minutes without leaking or coupling movement. For additional information and detailed instruction on testing procedures, see the Association for Rubber Products Manufacturer's (ARPM) handbook or visit ARPMINC.com.



for 1 Clamp



Size	Steel	
	Part #	Price/E
1/4"	KM21	\$7.65
5/16"	KM251	8.00
1/2"	KM41	8.80
5/8"	KM51	11.30
3/4"	KM61	8.90
1"	KM81	8.60
1-1/4"	KM101	7.80
1-1/2"	KM121	11.10

for 2 Clamps



Size	Steel	
	Part #	Price/E
1/2"	KM42	\$12.20
5/8"	KM52	12.25
3/4"	KM62	11.60
1"	KM82	11.90
1¼"	KM102	13.65
1½"	KM122	20.75
2"	KM162	29.30

Barbed Hose Menders



Hose ID	Lead Free Brass ¹		Brass		
	Part #	Price/E	Previous Part #	Part #	Price/E
1/8"	---	---	BM1	1780202C	\$1.98
3/16"	---	---	BM15	1780303C	1.83
1/4" x 1/8"	1780404CLF	\$9.27	BM2-1	1780402C	3.07
1/4"	---	---	BM2	1780404C	2.04
5/16"	---	---	BM25	1780505C	2.57
3/8" x 1/4"	1780606CLF	10.38	BM3-2	1780604C	3.41
3/8"	---	---	BM3	1780606C	2.40
1/2" x 3/8"	1780808CLF	11.59	BM4-3	1780806C	4.00
1/2"	---	---	BM4	1780808C	3.36
5/8" x 3/8"	---	---	BM5-3	1781006C	4.57
5/8" x 1/2"	---	---	BM5-4	1781008C	5.37
5/8"	---	---	BM5	1781010C	4.00
3/4" x 1/2"	---	---	BM6-4	1781208C	6.22
3/4"	---	---	BM6	1781212C	5.39
1"	---	---	BM8	1781616C	10.10

¹ Lead free brass <=0.25% lead; Alloy CA2745; Alloy C46400

Short Shank Menders



Size	Length	Previous Part #	316 Stainless Steel	
			Part #	Price/E
¼"	2-1/32"	1780404SS	RM2	\$15.20
⅜"	2-1/16"	1780606SS	RM3	16.30
½"	2-1/16"	1780808SS	RM4	24.45
¾"	2-1/2"	1781212SS	RM6	31.40

Male NPT x Hose Barb

• Optional package quantity

Hose ID	Male NPTF	Brass			Lead Free Brass ^{1,3}		316 Stainless Steel ¹		Pkg Qty
		Previous Part #	Part #	Price/E	Part #	Price/E	Part #	Price/E	
1/8"	1/8"	BN11	1020202C	\$1.71	---	---	RN11	\$14.00	100
	1/4"	BN122	1020204C	2.24	---	---	---	---	100
3/16"	1/8"	BN151	1020302C	1.88	1020302CLF	\$8.81	RN151	16.70	100
	1/4"	BN152	1020304C	2.42	---	---	RN152	16.20	100
1/4"	1/8"	BN21	1020402C	1.91	1020402CLF	7.57	RN21	13.20	100
	1/4"	BN22	1020404C	2.07	1020404CLF	7.52	RN22	11.60	100
	3/8"	BN23	1020406C	3.12	---	---	RN23	21.85	100
	1/2"	BN24	1020408C	6.31	---	---	---	---	50
5/16"	1/8"	BN251	1020502C	2.08	1020502CLF	8.88	RN251	15.00	100
	1/4"	BN252	1020504C	2.45	1020504CLF	8.89	RN252	17.60	50
	3/8"	BN253	1020506C	3.16	---	---	RN253	20.00	50
3/8"	1/8"	BN31	1020602C	2.40	1020602CLF	9.01	RN31	12.15	100
	1/4"	BN32	1020604C	2.10	1020604CLF	8.06	RN32	11.80	100
	3/8"	BN33	1020606C	3.16	1020606CLF	11.49	RN33	14.50	50
	1/2"	BN34	1020608C	5.50	1020608CLF	14.80	RN34	29.55	25
	3/4"	BN36	1020612C	7.71	---	---	---	---	25
1/2"	1/4"	BN42	1020804C	3.15	1020804CLF	12.92	RN42	15.50	50
	3/8"	BN43	1020806C	3.22	1020806CLF	11.75	RN43	22.15	50
	1/2"	BN44	1020808C	4.90	1020808CLF	17.28	RN44	28.95	25
	3/4"	BN46	1020812C	7.30	---	---	RN46	36.35	25
5/8"	3/4"	BN53	1021006C	3.64	---	---	RN53	24.25	50
	1/2"	BN54	1021008C	5.32	1021008CLF	18.33	RN54	27.00	25
	3/4"	BN56	1021012C	7.35	---	---	RN56	36.15	25
3/4"	1/2"	BN64	1021208C	6.22	1021208CLF	21.27	RN64	40.95	25
	3/4"	BN66	1021212C	6.75	1021212CLF	27.23	RN66	48.00	20
1"	3/4"	BN86	1021612C	9.08	---	---	RN86	54.00	20
	1"	BN88	1021616C ²	14.81	---	---	RKHN881 ⁴	78.50	10
1 1/4"	3/4"	BN106	1022012C	19.36	---	---	---	---	10
	1"	BN108	1022016C ²	17.97	---	---	---	---	5

¹ NPT thread

² capped

³ Lead free brass <=0.25% lead; Alloy CA2745; Alloy C46400

⁴ same shank style as KHN881 shown on page E-7



brass



316 stainless steel



Industrial Hose Fittings

Male NPTF Swivel x Hose Barb

• Optional package quantity

Hose ID	Male NPTF	Brass			Pkg Qty
		Previous Part #	Part #	Price/E	
1/4"	1/8"	103-0402	1030402C	\$7.64	100
	1/4"	103-0404	1030404C	5.70	100
3/8"	1/4"	103-0604	1030604C	6.02	100
	3/8"	103-0606	1030606C	6.64	50
1/2"	3/8"	103-0806	1030806C	8.09	50
	1/2"	103-0808	1030808C	9.85	25
3/4"	3/4"	103-1212	1031212C	13.08	20
1"	1-1 1/2"	103-1616	1031616C ¹	52.37	10

¹ capped threads / **150 PSI** maximum

• swivel is for assembly convenience only, not for live swivel applications





Male NPTF x Beaded Hose Barb

Hose ID	Male NPTF	Brass		Pkg Qty
		Part #	Price/E	
1/4"	1/8"	268B0402	\$2.50	100
	1/4"	268B0404	2.66	100
5/16"	1/8"	268B0502	2.59	100
	1/4"	268B0504	2.87	50
3/8"	1/8"	268B0602	3.02	100
	1/4"	268B0604	2.91	100
	3/8"	268B0606	3.73	50
1/2"	3/8"	268B0806	3.90	50
	1/2"	268B0808	6.70	50
5/8"	1/2"	268B1008	6.75	25
3/4"	1/2"	268B1208	7.12	50
	3/4"	268B1212	9.00	25

Male BSPT x Hose Barb



Hose ID	Male BSPT	Brass			Pkg Qty
		Previous Part #	Part #	Price/E	
1/4"	1/8"	BN21BSPT	1020402BSPT	\$2.86	100
	1/4"	BN22BSPT	1020404BSPT	3.11	100
3/8"	1/4"	BN32BSPT	1020604BSPT	3.90	100
	3/8"	BN33BSPT	1020606BSPT	4.42	50
	1/2"	BN34BSPT	1020608BSPT	9.04	25
1/2"	3/8"	BN43BSPT	1020806BSPT	5.07	50
	1/2"	BN44BSPT	1020808BSPT	6.52	50
3/4"	3/4"	BN66BSPT	1021212BSPT	8.56	25
1"	1"	BN88BSPT	1021616BSPT	18.10	10

Female NPT x Hose Barb



brass



303 stainless steel

Hose ID	Female NPTF	Brass			Lead Free Brass ^{1,2}		303 Stainless Steel ¹			Pkg Qty
		Previous Part #	Part #	Price/E	Part #	Price/E	Previous Part #	Part #	Price/E	
1/8"	1/8"	BF11	1040202C	\$2.62	---	---	---	---	---	100
	1/4"	BF12	1040204C	3.59	---	---	---	---	---	100
3/16"	1/8"	BF151	1040302C	2.59	---	---	---	---	---	100
	1/4"	BF152	1040304C	3.50	---	---	---	---	---	100
1/4"	1/8"	BF21	1040402C	2.20	---	---	---	---	---	100
	1/4"	BF22	1040404C	2.84	1040404CLF	\$13.16	BF22SS	1040404SS	\$28.58	100
	3/8"	BF23	1040406C	3.66	---	---	---	---	---	50
	1/2"	BF24	1040408C	5.41	---	---	---	---	---	50
5/16"	1/8"	BF251	1040502C	3.32	---	---	---	---	---	100
	1/4"	BF252	1040504C	3.40	---	---	---	---	---	100
	3/8"	BF253	1040506C	4.57	---	---	---	---	---	100
3/8"	1/8"	BF31	1040602C	2.96	---	---	---	---	---	100
	1/4"	BF32	1040604C	2.82	1040604CLF	13.18	BF32SS	1040604SS	26.21	50
	3/8"	BF33	1040606C	3.82	1040606CLF	17.49	BF33SS	1040606SS	29.15	50
	1/2"	BF34	1040608C	5.51	1040608CLF	24.61	---	---	---	50
	3/4"	BF36	1040612C	10.53	---	---	---	---	---	25
1/2"	1/4"	BF42	1040804C	3.42	---	---	---	---	---	50
	3/8"	BF43	1040806C	4.20	---	---	---	---	---	50
	1/2"	BF44	1040808C	5.36	1040808CLF	25.50	BF44SS	1040808SS	32.92	50
	3/4"	BF46	1040812C	9.82	---	---	---	---	---	25
5/8"	3/8"	BF53	1041006C	4.69	---	---	---	---	---	50
	1/2"	BF54	1041008C	5.50	---	---	---	---	---	25
	3/4"	BF56	1041012C	9.81	---	---	---	---	---	25
3/4"	1/2"	BF64	1041208C	6.10	---	---	---	---	---	25
	3/4"	BF66	1041212C	10.40	---	---	---	---	---	20
1"	3/4"	BF86	1041612C	11.19	---	---	---	---	---	20
	1"	BF88	1041616C	17.00	---	---	---	---	---	10
1-1/4"	1"	BF108	1042016C	17.76	---	---	---	---	---	10

¹ NPT threads and are packaged to order

² Lead free brass <=0.25% lead; Alloy CA2745; Alloy C46400

Female NPSM Swivel x Hose Barb Ball Seat

Hose ID	Female NPSM	Brass			Pkg Qty
		Previous Part #	Part #	Price/E	
1/8"	1/8"	BFS11	1240202K	\$3.11	100
3/16"	1/8"	BFS151	1240302K	2.42	100
	1/4"	BFS152	1240304K	3.45	100
1/4"	1/8"	BFS21	1240402K	3.20	100
	1/4"	BFS22	1240404K	3.12	100
	3/8"	BFS23	1240406K	4.78	100
5/16"	1/4"	BFS252	1240504K	4.53	100
	3/8"	BFS253	1240506K	6.19	50
3/8"	1/4"	BFS32	1240604K	3.03	100
	3/8"	BFS33	1240606K	4.20	100
	1/2"	BFS34	1240608K	7.06	100
1/2"	3/8"	BFS43	1240806K	7.35	50
	1/2"	BFS44	1240808K	6.37	100
3/4"	3/4"	BFS66	1241212K	9.97	50



Industrial Hose Fittings

Female NPSM Swivel x Hose Barb Gasket Seat

Hose ID	Female NPSM	Brass			Pkg Qty
		Previous Part #	Part #	Price/E	
1/8"	1/8"	126-0202	1260202C	\$5.52	100
3/16"	1/8"	126-0302	1260302C	5.35	100
	1/4"	126-0304	1260304C	5.90	100
1/4"	1/8"	126-0402	1260402C	5.70	100
	1/4"	126-0404	1260404C	5.32	100
	3/8"	126-0406	1260406C	6.82	100
5/16"	1/4"	126-0504	1260504C	6.87	100
3/8"	1/4"	126-0604	1260604C	5.11	100
	3/8"	126-0606	1260606C	6.31	50
	1/2"	126-0608	1260608C	7.83	50
1/2"	3/8"	126-0806	1260806C	9.27	50
	1/2"	126-0808	1260808C	7.38	50
3/4"	3/4"	126-1212	1261212C	9.36	25



- not recommended for water applications

Male NPT x Hose Barb 90° Elbow



Hose ID	Male NPTF	Brass			Lead Free Brass ²	
		Previous Part #	Part #	Price/E	Part #	Price/E
3/16"	1/8"	EL15H1M	1290302C	\$3.69	---	---
1/4"	1/8"	EL2H1M	1290402C	3.45	---	---
	1/4"	EL2H2M	1290404C	5.01	1290404CLF	\$15.86
	3/8"	EL2H3M	1290406C	6.20	---	---
5/16"	1/8"	EL25H1M	1290502C	4.25	---	---
	1/4"	EL25H2M	1290504C	5.62	---	---
	3/8"	EL25H3M	1290506C	6.25	---	---
3/8"	1/8"	EL3H1M	1290602C	3.76	---	---
	1/4"	EL3H2M	1290604C	5.01	1290604CLF	32.57
	3/8"	EL3H3M	1290606C	6.60	1290606CLF	12.96
	1/2"	EL3H4M	1290608C	9.25	---	---
1/2"	1/4"	EL4H2M	1290804C	5.50	---	---
	3/8"	EL4H3M	1290806C	6.80	---	---
	1/2"	EL4H4M	1290808C	9.07	---	---
5/8"	3/8"	EL5H3M	1291006C	11.61	---	---
	1/2"	EL5H4M	1291008C	12.46	---	---
3/4"	1/2"	EL6H4M	1291208C	15.55	---	---
	3/4"	EL6H6M	1291212C	21.78	---	---
1"	3/4"	EL8H6M	1291612C	27.46	---	---
	1"	EL8H8M	1291616C ¹	36.17	---	---

¹ capped² Lead free brass <=0.25% lead; Alloy CA2745; Alloy C46400

Hose ID	Male NPTF	Stainless Steel			Pkg Qty
		Previous Part #	Part #	Price/E	
1/4"	1/8"	EL2H1MSS	1290402SS	\$28.61	50
	1/4"	EL2H2MSS	1290404SS	27.18	50
3/8"	1/4"	EL3H2MSS	1290604SS	28.15	50
	3/8"	EL3H3MSS	1290606SS	26.76	50
1/2"	1/4"	EL4H2MSS	1290804SS	31.95	50
	3/8"	EL4H3MSS	1290806SS	43.45	50
	1/2"	EL4H4MSS	1290808SS	31.68	25
3/4"	1/2"	EL6H4MSS	1291208SS	60.73	25
	3/4"	EL6H6MSS	1291212SS	58.10	25

Female NPTF x Hose Barb 90° Elbow



Hose ID	Female NPTF	Brass			Pkg Qty
		Previous Part #	Part #	Price/E	
1/4"	1/8"	134-0402	1340402C	\$5.82	50
	1/4"	134-0404	1340404C	7.72	50
3/8"	1/4"	134-0604	1340604C	7.27	50
	3/8"	134-0606	1340606C	10.10	50
1/2"	1/4"	134-0804	1340804C	6.86	25
	3/8"	134-0806	1340806C	11.36	25
	1/2"	134-0808	1340808C	23.44	25
3/4"	3/4"	134-1212	1341212C	34.35	25

Barbed 90° Elbow Splicers

Hose ID	Brass			304 Stainless Steel			Pkg Qty
	Previous Part #	Part #	Price/E	Previous Part #	Part #	Price/E	
1/8"	177-0202	1770202C	\$4.58	177-0202SS	1770202SS	\$18.85	25
3/16"	177-0303	1770303C	4.00	177-0303SS	1770303SS	38.20	25
1/4" x 1/8"	177-0402	1770402C	5.35	---	---	---	25
1/4"	177-0404	1770404C	3.78	177-0404SS	1770404SS	11.45	25
5/16"	177-0505	1770505C	6.12	---	---	---	25
3/8" x 1/4"	177-0604	1770604C	6.16	---	---	---	25
3/8"	177-0606	1770606C	5.80	177-0606SS	1770606SS	15.84	25
1/2" x 3/8"	177-0806	1770806C	7.00	---	---	---	25
1/2"	177-0808	1770808C	6.96	177-0808SS	1770808SS	30.85	25
5/8"	177-1010	1771010C	13.65	---	---	---	25
3/4" x 1/2"	177-1208	1771208C	14.25	---	---	---	25
3/4"	177-1212	1771212C	18.17	---	---	---	25



Industrial Hose Fittings

Barbed Tee Splicers

Hose ID	Brass			Lead Free Brass		Pkg Qty
	Previous Part #	Part #	Price/E	Part #	Price/E	
1/8"	179-0202	1790202C	\$5.83	---	---	25
3/16"	179-0303	1790303C	4.73	---	---	100
1/4" x 1/8"	179-0402	1790402C	5.85	---	---	25
1/4"	179-0404	1790404C	4.56	1790404CLF	\$8.72	25
5/16"	179-0505	1790505C	6.21	---	---	25
3/8" x 1/4"	179-0604	1790604C ¹	10.65	---	---	25
3/8" x 1/4"	---	1790604BARB	6.76	---	---	25
3/8"	179-0606	1790606C	6.06	1790606CLF	10.22	25
1/2" x 3/8"	179-0806	1790806C	9.95	---	---	25
1/2"	179-0808	1790808C	8.86	---	---	25
5/8"	179-1010	1791010C	13.25	---	---	25
3/4" x 1/2"	179-1208	1791208C	19.63	---	---	25
3/4"	179-1212	1791212C	18.82	---	---	20

¹ drop leg has 1/4"-18 male NPTF thread

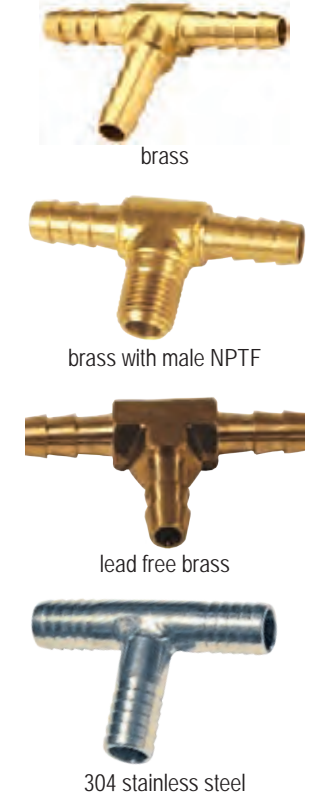

Hose ID	304 Stainless Steel		
	Previous Part #	Part #	Price/E
1/8"	179-0202SS	1790202SS	\$38.20
3/16"	179-0303SS	1790303SS	30.60
1/4"	179-0404SS	1790404SS	26.37
3/8"	179-0606SS	1790606SS	32.32
1/2"	179-0808SS	1790808SS	49.23



Male NPTF x Hose Barb 45° Elbow

Hose ID	Female NPTF	Brass			Pkg Qty
		Previous Part #	Part #	Price/E	
1/4"	1/8"	139-0402	1390402C	\$4.22	100
	1/4"	139-0404	1390404C	6.60	25
3/8"	1/8"	139-0602	1390602C	5.20	100
	1/4"	139-0604	1390604C	4.91	100
	3/8"	139-0606	1390606C	8.00	25
1/2"	1/4"	139-0804	1390804C	7.82	25
	3/8"	139-0806	1390806C	7.45	25
	1/2"	139-0808	1390808C	9.83	25
3/4"	1/2"	139-1208	1391208C	16.23	25

Male 45° SAE x Hose Barb



Hose ID	Male UNF	Brass			Pkg Qty
		Previous Part #	Part #	Price/E	
3/16"	7/16"-20	142-0307	1420307C	\$3.53	100
1/4"	7/16"-20	142-0407	1420407C	2.66	100
	5/8"-18	142-0410	1420410C	3.69	100
5/16"	1/2"-20	142-0508	1420508C	3.12	100
3/8"	5/8"-18	142-0610	1420610C	3.75	50
	3/4"-16	142-0612	1420612C	6.10	50
1/2"	3/4"-16	142-0812	1420812C	5.21	50

Female 45°SAE/37°JIC Swivel x Hose Barb



Hose ID	Tube OD	Female UNF	Brass			Pkg Qty
			Previous Part #	Part #	Price/E	
3/16"	1/4"	7/16"-20	143-0307	1430307K	\$3.03	100
	1/4"	7/16"-20	143-0407	1430407K	3.08	100
1/4"	1/4"	7/16"-20	---	1430407KLF¹	6.53	---
	5/16"	1/2"-20	143-0408	1430408K	6.08	100
5/16"	5/16"	1/2"-20	143-0508	1430508K	6.21	50
3/8"	1/2"	3/4"-16	143-0612	1430612K	6.15	100
1/2"	1/2"	3/4"-16	143-0812	1430812K	5.33	100
	5/8"	7/8"-14	143-0814	1430814K	10.05	50

¹ Lead free brass <=0.25% lead; Alloy CA2745; Alloy C46400

Female 45° SAE Swivel x Hose Barb

Hose ID	Tube OD	Female UNF	Previous Part #	Brass		Pkg Qty
				Part #	Price/E	
3/16"	3/16"	3/8"-24	144-0306	1440306K	\$5.07	100
1/4"	3/8"	5/8"-18	144-0410	1440410K	4.26	100
5/16"	3/8"	5/8"-18	144-0510	1440510K	4.90	100
3/8"	3/8"	5/8"-18	144-0610	1440610K	4.21	100
1/2"	1/2"	3/4"-16	144-0812	1440812K	5.79	100
3/4"	3/4"	1-1/16"-14	144-1217	1441217K¹	13.13	25



Industrial Hose Fittings

¹ Notch in nut for SAE identification

Female 37° JIC Swivel x Hose Barb

Hose ID	Tube OD	Female UNF	Previous Part #	Brass		Pkg Qty
				Part #	Price/E	
3/8"	3/8"	9/16"-18	145-0609	1450609K	\$3.50	100
3/4"	3/4"	1-1/16"-12	145-1217	1451217K	14.08	25



Female PTF-SAE Short Swivel x Hose Barb

Hose ID	Female PTF-SAE Short	Previous Part #	Brass		Pkg Qty
			Part #	Price/E	
1/4"	1/4"	105-0404	1050404C	\$7.34	50
3/8"	1/4"	105-0604	1050604C	7.56	50
	3/8"	105-0606	1050606C	7.85	50
1/2"	3/8"	105-0806	1050806C	9.41	50
	1/2"	105-0808	1050808C	9.83	25



- swivel is for assembly convenience only, not for live swivel applications

Assembly Instructions:

1. Trim hose end with smooth square cut
2. Lubricate either push-on fitting, hose or both.
3. Insert push-on fitting into hose until first barb is in hose.
4. Place end of fitting against a flat object (bench, wall, etc.) and grip the hose one inch from end. Push with a steady force until end of hose is covered by yellow plastic cap.

Disassembly Instructions:

1. Leaving push-on fitting in place, make a 1" cut in the hose along the barbed end of the fitting. Note: Be careful not to nick barbs when cutting the hose.
2. With firm grip on hose, give a sharp downward pull to release the fitting from the hose.

• **intended for use with Lok-On (push-on style) hose only**

- No hose clamps or ferrules are needed for installation
- Properly grips push-on hose only when pushed all the way in, with the cut end of the hose completely concealed by the plastic cap.



Male NPTF x Push-on Hose Barb

- refer to page E-31 for Push-On garden hose thread fittings
- optional package quantity

Hose ID	Male NPTF	Brass				Brass Cap Option			Lead Free Brass ^{1,3}		
		Previous Part #	Part #	Price/E	Pkg Qty	Part #	Price/E	Pkg Qty	Part #	Price/E	Pkg Qty
1/4"	1/8"	BPN21	2720402C	\$2.21	100	2720402CBC	\$3.92	100	2720402CLF	\$5.81	100
	1/4"	BPN22	2720404C	2.60	100	2720404CBC	4.52	100	2720404CLF	7.18	100
	3/8"	BPN23	2720406C	3.41	50	2720406CBC	5.96	50	---	---	---
5/16"	1/8"	BPN251	2720502C	3.74	100	---	---	---	---	---	---
	1/4"	BPN252	2720504C	3.27	50	---	---	---	---	---	---
3/8"	1/8"	BPN31	2720602C	3.53	100	2720602CBC	5.72	100	---	---	---
	1/4"	BPN32	2720604C	2.90	50	2720604CBC	4.88	50	2720604CLF	7.33	50
	3/8"	BPN33	2720606C	3.36	50	2720606CBC	5.68	50	2720606CLF	9.99	50
	1/2"	BPN34	2720608C	5.55	25	2720608CBC	7.96	25	---	---	---
	3/4"	BPN36	2720612C	9.55	25	2720612CBC	11.71	25	---	---	---
1/2"	1/4"	BPN42	2720804C	4.11	25	2720804CBC	6.76	25	---	---	25
	3/8"	BPN43	2720806C	3.70	25	2720806CBC	5.60	25	2720806CLF	11.52	50
	1/2"	BPN44	2720808C	5.35	50	2720808CBC	7.71	50	2720808CLF	19.02	25
5/8"	3/8"	BPN53	2721006C	6.55	25	2721006CBC	8.40	25	---	---	---
	1/2"	BPN54	2721008C	7.27	25	2721008CBC	9.48	25	---	---	---
	3/4"	BPN56	2721012C	9.72	25	2721012CBC	13.60	25	---	---	---
3/4"	1/2"	BPN64	2721208C	8.42	25	2721208CBC	10.80	25	---	---	25
	3/4"	BPN66	2721212C	8.95	25	2721212CBC	11.60	25	---	---	20
1"	3/4"	BPN86	2721612C	19.65	10	---	---	---	---	---	---
	1"	BPN88	2721616C ²	23.73	10	---	---	---	---	---	5



brass



brass cap



303 stainless steel

Hose ID	Male NPT	303 Stainless Steel			Pkg Qty
		Previous Part #	Part #	Price/E	
1/4"	1/8"	RPN21	2720402SS	\$30.28	100
	1/4"	RPN22	2720404SS	24.00	100
3/8"	1/4"	RPN32	2720604SS	34.37	50
	3/8"	RPN33	2720606SS	35.85	50
1/2"	1/4"	RPN42	2720804SS	34.37	25
	3/8"	RPN43	2720806SS	38.46	50
	1/2"	RPN44	2720808SS	47.95	25
3/4"	1/2"	RPN64	2721208SS	54.82	25
	3/4"	RPN66	2721212SS	69.88	20
1"	1"	RPN88	2721616SS ²	95.73	5

¹ Lead free brass <=0.25% lead; Alloy CA2745; Alloy C46400

² capped

³ NPT threads 272LF

Male NPTF Swivel x Push-on Hose Barb

Hose ID	Male NPTF	Brass			Pkg Qty
		Previous Part #	Part #	Price/E	
1/4"	1/8"	271-0402	2710402C	\$7.45	100
	1/4"	271-0404	2710404C	6.17	100
3/8"	1/4"	271-0604	2710604C	6.60	50
	3/8"	271-0606	2710606C	7.40	50
1/2"	3/8"	271-0806	2710806C	7.96	25
	1/2"	271-0808	2710808C	10.00	20
3/4"	3/4"	271-1212	2711212C	14.75	10



- swivel is for assembly convenience only, not for live swivel applications, 120 PSI maximum

- **intended for use with Lok-On (push-on style) hose only**
- No hose clamps or ferrules are needed for installation
- Properly grips push-on hose only when pushed all the way in, with the cut end of the hose completely concealed by the plastic cap.



Male NPTF x Push-on Hose Barb 90° Elbow

Hose ID	Male NPTF	Brass			Pkg Qty
		Previous Part #	Part #	Price/E	
1/4"	1/8"-27	273-0402	2730402C	\$4.32	100
	1/4"-18	273-0404	2730404C	5.41	50
3/8"	1/8"-27	273-0602	2730602C	7.26	50
	1/4"-18	273-0604	2730604C	6.34	50
1/2"	3/8"-18	273-0606	2730606C	7.36	25
	1/2"-14	273-0806	2730806C	9.36	25
3/4"	1/2"-14	273-0808	2730808C	11.76	25
	3/4"-14	273-1208	2731208C	24.00	10
		273-1212	2731212C	22.90	10



Female NPTF x Push-on Hose Barb

- refer to page E-31 for Push-On garden hose thread fittings

Hose ID	Female NPTF	Brass			Pkg Qty
		Previous Part #	Part #	Price/E	
1/4"	1/8"	BPF21	2740402C	\$3.30	100
	1/8"	---	2740402CBC¹	5.68	---
	1/4"	BPF22	2740404C	3.46	100
	1/4"	---	2740404CBC¹	5.93	---
	3/8"	BPF23	2740406C	5.61	50
5/16"	3/8"	---	2740406CBC¹	8.00	---
	1/8"	BPF251	2740502C	4.85	100
3/8"	1/4"	BPF252	2740504C	5.35	50
	1/8"	BPF31	2740602C	5.71	50
	1/8"	---	2740602CBC¹	7.89	---
	1/4"	BPF32	2740604C	3.87	50
	1/4"	---	2740604CBC¹	7.04	---
1/2"	3/8"	BPF33	2740606C	4.23	50
	3/8"	---	2740606CBC¹	6.82	---
	1/2"	BPF34	2740608C	6.15	50
	3/4"	BPF36	2740612C	14.95	25
	1/4"	BPF42	2740804C	5.32	50
5/8"	1/4"	---	2740804CBC¹	9.83	---
	3/8"	BPF43	2740806C	5.07	50
	3/8"	---	2740806CBC¹	8.34	---
	1/2"	BPF44	2740808C	5.65	25
	1/2"	---	2740808CBC¹	9.17	---
3/4"	3/4"	BPF46	2740812C	12.69	25
	3/4"	---	2740812CBC¹	14.44	---
	3/8"	BPF53	2741006C	7.94	25
	1/2"	BPF54	2741008C	7.45	25
1"	1/2"	---	2741008CBC¹	9.96	---
	3/4"	BPF64	2741208C	8.69	25
	3/4"	BPF66	2741212C	12.02	25
1"	3/4"	---	2741212CBC¹	14.42	---
	1"	BPF86	2741612C	17.53	10
		BPF88	2741616C	20.36	10



brass cap

¹ brass cap on CBC parts

- **intended for use with Lok-On (push-on style) hose only**
- No hose clamps or ferrules are needed for installation
- Properly grips push-on hose only when pushed all the way in, with the cut end of the hose completely concealed by the plastic cap.



Female NPSM Swivel x Push-on Hose Barb Ball Seat



brass cap

Hose ID	Female NPSM	Brass			Pkg Qty
		Previous Part #	Part #	Price/E	
1/4"	1/8"	BPFS21	2780402C	\$8.12	100
	1/8"	---	2780402CBC ¹	10.69	---
	1/4"	BPFS22	2780404C	5.49	50
	1/4"	---	2780404CBC ¹	8.24	---
	3/8"	BPFS23	2780406C	10.63	50
3/8"	3/8"	---	2780406CBC ¹	13.41	---
	1/4"	BPFS32	2780604C	6.06	50
	1/4"	---	2780604CBC ¹	9.20	---
	3/8"	BPFS33	2780606C	7.70	50
	3/8"	---	2780606CBC ¹	10.74	---
1/2"	1/2"	BPFS34	2780608C	9.91	50
	1/2"	---	2780808C	9.14	50
	1/2"	---	2780808CBC ¹	11.44	---
1/2"	3/4"	BPFS46	2780812C	14.66	25
	3/4"	---	2780812CBC ¹	14.80	---
	5/8"	BPFS56	2781012C	21.18	25
3/4"	3/4"	BPFS66	2781212C	16.21	20
	3/4"	---	2781212CBC ¹	17.76	---

¹ brass cap on CBC parts

Female NPSM Swivel x Push-on Hose Barb Gasket Seat



brass cap

Hose ID	Female NPSM	Brass			Pkg Qty
		Previous Part #	Part #	Price/E	
1/4"	1/8"	280-0402	2800402C	\$10.80	100
	1/8"	---	2800402CBC ¹	13.56	---
	1/4"	280-0404	2800404C	6.98	100
	1/4"	---	2800404CBC ¹	11.03	---
3/8"	1/4"	280-0604	2800604C	9.30	50
	1/4"	---	2800604CBC ¹	12.11	---
	3/8"	280-0606	2800606C	10.29	50
	3/8"	---	2800606CBC ¹	13.77	---
	1/2"	280-0608	2800608C	11.37	50
1/2"	1/2"	---	2800608CBC ¹	14.57	---
	1/2"	280-0808	2800808C	9.82	25
	1/2"	---	2800808CBC ¹	13.55	---
5/8"	1/2"	280-1008	2801008C	14.38	25
3/4"	3/4"	280-1212	2801212C	18.18	20
	3/4"	---	2801212CBC ¹	18.80	---

- ¹ brass cap on CBC parts
- not recommended for use with water

Push-On Hose Menders



brass cap

Hose ID	Brass			303 Stainless Steel			Pkg Qty
	Previous Part #	Part #	Price/E	Previous Part #	Part #	Price/E	
1/4"	BPM2	2960404C	\$3.00	SSPM2	2960404SS	\$34.37	100
	---	2960404CBC ¹	4.48	---	---	---	---
5/16"	BPM25	2960505C	3.99	---	---	---	100
3/8"	BPM3	2960606C	3.40	SSPM3	2960606SS	39.28	50
	---	2960606CBC ¹	5.48	---	---	---	---
1/2"	BPM4	2960808C	5.50	SSPM4	2960808SS	43.61	50
	---	2960808CBC ¹	7.71	---	---	---	---
5/8"	BPM5	2961010C	7.86	SSPM5	---	---	20
	---	2961010CBC ¹	10.00	---	---	---	---
3/4"	BPM6	2961212C	9.25	SSPM6	---	---	15
	---	2961212CBC ¹	11.52	---	---	---	---
1"	BPM8	2961616C	16.20	---	---	---	10

- ¹ brass cap on CBC parts
- for Tuff-Lite™ hose menders in nylon and polypropylene see page E-54

- **intended for use with Lok-On (push-on style) hose only**
- No hose clamps or ferrules are needed for installation
- Properly grips push-on hose only when pushed all the way in, with the cut end of the hose completely concealed by the plastic cap.



Lok-On Male Garden Hose Fittings

Hose ID	GHT Thread	Brass		
		Previous Part #	Part #	Price/E
1/2"	3/4"	572-0812	5720812C	\$10.26
5/8"	3/4"	572-1012	5721012C	12.00
3/4"	3/4"	572-1212	5721212C	12.05

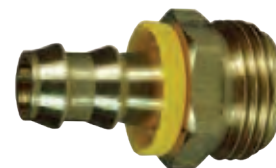

Lok-On Female Swivel Garden Hose Fittings

Hose ID	GHT Thread	Brass		
		Previous Part #	Part #	Price/E
1/2"	3/4"	574-0812	5740812C	\$12.76
5/8"	3/4"	574-1012	5741012C	14.03
3/4"	3/4"	574-1212	5741212C	14.06



Lok-On Garden Hose Fitting Sets

Feature:

- washer included, part # **5911212W** on page E-47

Hose ID	GHT Thread	Brass		
		Previous Part #	Part #	Price/E
1/2"	3/4"	575-0808	5750808K	\$22.16
5/8"	3/4"	575-1010	5751010K	25.07
3/4"	3/4"	575-1212	5751212K	25.13



SAE Thread Size to UNF Thread Size Interchange

SAE Thread number	SAE Tube OD	UNF Thread size	SAE Thread number	SAE Tube OD	UNF Thread size
02	1/8"	5/16" - 24	07	7/16"	11/16" - 24
03	3/16"	3/8" - 24	08	1/2"	3/4" - 16
04	1/4"	7/16" - 20	10	5/8"	7/8" - 14
05	5/16"	1/2" - 20	12	3/4"	1-1/16" - 14
06	3/8"	5/8" - 18	---	---	---

Male 45° SAE Swivel x Push-on Hose Barb

Hose ID	Tube OD	Male UNF	Brass			Pkg Qty
			Previous Part #	Part #	Price/E	
1/4"	1/4"	7/16"-20	282-0407	2820407C	\$3.85	100
	1/4"	7/16"-20	---	2820407CBC ²	5.40	---
	5/16"	1/2"-20	282-0408	2820408C	3.74	100
	5/16"	1/2"-20	---	2820408CBC ²	6.96	---
3/8"	3/8"	5/8"-18 ¹	282-0610	2820610C	6.02	50
	3/8"	5/8"-18 ¹	---	2820610CBC ²	7.08	---
1/2"	1/2"	3/4"-16	282-0812	2820812C	6.66	50
	1/2"	3/4"-16	---	2820812CBC ²	9.00	---
5/8"	5/8"	7/8"-14	282-1014	2821014C	9.56	25
	5/8"	7/8"-14	---	2821014CBC ²	13.94	---
3/4"	3/4"	1-1/16"-14 ¹	282-1217	2821217C	15.46	25
	3/4"	1-1/16"-14 ¹	---	2821217CBC ²	16.08	---



brass cap

¹ notch in nut for SAE identification

² brass cap on CBC parts

- **intended for use with Lok-On (push-on style) hose only**
- No hose clamps or ferrules are needed for installation
- Properly grips push-on hose only when pushed all the way in, with the cut end of the hose completely concealed by the plastic cap.



Female 45° SAE Swivel x Push-on Hose Barb

- SAE thread size to UNF thread size interchange chart on previous page



brass cap

Hose ID	Tube OD	Female UNF	Brass			Pkg Qty
			Previous Part #	Part #	Price/E	
1/4"	3/8"	5/8"-18 ¹	284-0410	2840410C	\$6.73	50
	3/8"	5/8"-18 ¹	---	2840410CBC²	9.04	---
5/16"	3/8"	5/8"-18 ¹	284-0510	2840510C	6.85	50
3/8"	3/8"	5/8"-18 ¹	284-0610	2840610C	5.05	100
	3/8"	5/8"-18 ¹	---	2840610CBC²	7.68	---
3/4"	3/8"	1-1/16"-14 ¹	284-1217	2841217C	13.00	25
	3/8"	1-1/16"-14 ¹	---	2841217CBC²	16.00	---

¹ notch in nut for SAE identification

² brass cap on CBC parts

JIC Thread Size to UNF Thread Size Interchange

JIC Thread Number	JIC Tube OD	UNF Thread Size	JIC Thread Number	JIC Tube OD	UNF Thread Size
02	1/8"	5/16"-24	12	3/4"	1-1/16" - 12
03	3/16"	3/8" - 24	14	7/8"	1-3/16" - 12
04	1/4"	7/16" - 20	16	1"	1-5/16" - 12
05	5/16"	1/2" - 20	20	1-1/4"	1-5/8" - 12
06	3/8"	9/16" - 18	24	1-1/2"	1-7/8" - 12
08	1/2"	3/4" - 16	28	1-3/4"	2-1/4" - 12
10	5/8"	7/8" - 14	32	2"	2-1/2" - 12

Male 37° JIC x Push-on Hose Barb

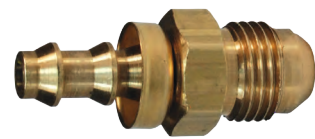

brass cap

Hose ID	Tube OD	Male UNF	Brass			Pkg Qty
			Previous Part #	Part #	Price/E	
1/4"	1/4"	7/16"-20	286-0407	2860407C	\$3.80	100
	1/4"	7/16"-20	---	2860407CBC²	6.24	---
	5/16"	1/2"-20	286-0408	2860408C	9.14	50
	3/8"	9/16"-18	286-0409	2860409C	6.30	100
3/8"	3/8"	9/16"-18	---	2860409CBC²	8.30	---
	3/8"	9/16"-18	286-0609	2860609C	5.50	50
1/2"	3/8"	9/16"-18	---	2860609CBC²	7.88	---
	1/2"	3/4"-16	286-0812	2860812C	7.37	25
5/8"	1/2"	3/4"-16	---	2860812CBC²	9.58	---
	5/8"	7/8"-14	286-1014	2861014C	10.43	25
3/4"	5/8"	7/8"-14	---	2861014CBC²	13.88	---
	3/4"	1-1/16"-12	286-1217	2861217C¹	14.25	10
	3/4"	1-1/16"-12	---	2861217CBC^{1,2}	15.93	---

¹ UN Thread

² brass cap on CBC parts

- **intended for use with Lok-On (push-on style) hose only**
- No hose clamps or ferrules are needed for installation
- Properly grips push-on hose only when pushed all the way in, with the cut end of the hose completely concealed by the plastic cap.



Female 45°SAE/37°JIC Swivel x Push-on Hose Barb

Hose ID	Tube OD	Female UNF	Previous Part #	Brass			Lead Free Brass ¹	
				Part #	Price/E	Pkg Qty	Part #	Price/E
1/4"	1/4"	7/16"-20	287-0407	2870407C	\$3.96	100	2870407CLF	\$7.57
	1/4"	7/16"-20	---	2870407CBC ²	6.80	---	---	---
	5/16"	1/2"-20	287-0408	2870408C	5.27	100	---	---
	5/16"	1/2"-20	---	2870408CBC ²	7.36	---	---	---
3/8"	5/16"	1/2"-20	287-0608	2870608C	7.89	25	---	---
	1/2"	3/4"-16	287-0612	2870612C	6.30	25	---	---
	1/2"	3/4"-16	---	2870612CBC ²	9.40	---	---	---
1/2"	1/2"	3/4"-16	287-0812	2870812C	6.36	25	---	---
	1/2"	3/4"-16	---	2870812CBC ²	9.12	---	---	---
	5/8"	7/8"-14	287-0814	2870814C	9.11	25	---	---
5/8"	5/8"	7/8"-14	---	2870814CBC ²	11.77	---	---	---
	5/8"	7/8"-14	287-1014	2871014C	9.71	25	---	---
3/4"	5/8"	7/8"-14	---	2871014CBC ²	12.70	---	---	---
	5/8"	7/8"-14	287-1214	2871214C	17.60	25	---	---
3/4"	5/8"	7/8"-14	---	2871214CBC ²	19.61	---	---	---

Hose ID	Tube OD	Female UNF	Stainless Steel		
			Previous Part #	Part #	Price/E
1/4"	1/4"	7/16"-20	287-0407SS	2870407SS	\$46.95
1/2"	1/2"	3/4"-16	287-0812SS	2870812SS	65.45



plastic cap



brass cap



stainless steel

¹ lead free brass <=0.25% lead; Alloy CA2745; Alloy C46400
² brass cap on CBC parts

Female 37° JIC Swivel x Push-on Hose Barb

Hose ID	Tube OD	Female UNF	Previous Part #	Brass		Pkg Qty
				Part #	Price/E	
1/4"	3/8"	9/16"-18	288-0409	2880409C	\$6.06	50
	3/8"	9/16"-18	---	2880409CBC ¹	7.76	---
5/16"	3/8"	9/16"-18	288-0509	2880509C	6.21	50
3/8"	3/8"	9/16"-18	288-0609	2880609C	5.21	50
	3/8"	9/16"-18	---	2880609CBC ¹	7.52	---
1/2"	3/8"	9/16"-18	288-0809	2880809C	7.67	25
3/4"	3/4"	1-1/16"-12 ²	288-1217	2881217C	13.49	10
	3/4"	1-1/16"-12 ²	---	2881217CBC ¹	15.84	---
1"	1"	1-5/16"-12 ²	288-1621	2881621C	30.83	10

Hose ID	Tube OD	Female UNF	303 Stainless Steel		
			Previous Part #	Part #	Price/E
3/8"	3/8"	9/16"-18	288-0609SS	2880609SS	62.70
3/4"	3/4"	1-1/16"-12 ²	288-1217SS	2881217SS	112.20
1"	1"	1-5/16"-12 ²	288-1621SS	2881621SS	122.70



brass



303 stainless steel

¹ brass cap on CBC parts

² UN Thread

Female 37° JIC / 45° SAE Swivel x Push-on 90° Elbow

Hose ID	Tube OD	Female UNF	Previous Part #	Plated Steel		Pkg Qty
				Part #	Price/E	
1/4"	1/4"	7/16"-20	289-0407	2890407C ²	\$27.00	25
	1/4"	7/16"-20	289-0407SAE	2890407CSAE ¹	35.72	25
3/8"	3/8"	9/16"-18	289-0609	2890609C ²	25.35	25
	3/8"	9/16"-18	289-0610SAE	2890610CSAE ¹	36.45	25
1/2"	1/2"	3/4"-16	289-0812	2890812C ²	31.10	10
3/4"	3/4"	1-1/16"-12 ³	289-1217	2891217C ²	81.40	5



¹ notch in nut for SAE identification

² JIC only, may substitute dual angle

³ UN thread

- **intended for use with Lok-On (push-on style) hose only**
- No hose clamps or ferrules are needed for installation
- Properly grips push-on hose only when pushed all the way in, with the cut end of the hose completely concealed by the plastic cap.



Male SAE Inverted Flare Swivel x Push-on Hose Barb



brass cap

Hose ID	Tube OD	Male UNF	Brass			Pkg Qty
			Previous Part #	Part #	Price/E	
1/4"	3/16"	3/8"-24	290-0406	2900406C	\$9.34	100
	3/16"	3/8"-24	---	2900406CBC²	11.60	---
	1/4"	7/16"-24 ¹	290-0407	2900407C	6.44	100
	1/4"	7/16"-24 ¹	---	2900407CBC²	9.12	---
	5/16"	1/2"-20	290-0408	2900408C	7.68	100
	5/16"	1/2"-20	---	2900408CBC²	8.72	---
5/16"	5/16"	1/2"-20	290-0508	2900508C	8.31	50
	3/8"	5/8"-18	290-0510	2900510C	11.31	50
3/8"	5/16"	1/2"-20	290-0608	2900608C	9.60	100
	5/16"	1/2"-20	---	2900608CBC²	13.37	---
	3/8"	5/8"-18	290-0610	2900610C	9.02	50
	3/8"	5/8"-18	---	2900610CBC²	10.60	---
1/2"	1/2"	3/4"-18 ¹	290-0812	2900812C	11.84	50
	1/2"	3/4"-18 ¹	---	2900812CBC²	13.80	---
5/8"	5/8"	7/8"-18 ¹	290-1014	2901014C	15.57	25
	5/8"	7/8"-18 ¹	---	2901014CBC²	17.25	---

¹ UNS thread
² brass cap on CBC parts

Female SAE Inverted Flare Rigid x Push-on Hose Barb

Hose ID	Tube OD	Female UNF	Brass			Pkg Qty
			Previous Part #	Part #	Price/E	
1/4"	3/16"	3/8"-24	292-0406	2920406C	\$4.89	100
	3/16"	3/8"-24	---	2920406CBC²	6.60	---
	1/4"	7/16"-24 ¹	292-0407	2920407C	3.82	100
	1/4"	7/16"-24 ¹	---	2920407CBC²	6.00	---
	5/16"	1/2"-20	292-0408	2920408C	4.78	100
	5/16"	1/2"-20	---	2920408CBC²	6.48	---
5/16"	5/16"	1/2"-20	292-0508	2920508C	5.10	100
3/8"	5/16"	1/2"-20	292-0608	2920608C	5.76	100
	5/16"	1/2"-20	---	2920608CBC²	7.40	---
	3/8"	5/8"-18	292-0610	2920610C	5.49	50
	3/8"	5/8"-18	---	2920610CBC²	7.79	---
1/2"	1/2"	3/4"-18 ¹	292-0812	2920812C	8.18	25
	1/2"	3/4"-18 ¹	---	2920812CBC²	11.15	---

¹ UNS Thread
² brass cap on CBC parts

Rigid Tube x Push-on Hose Barb



Hose ID	Tube OD	Brass			303 Stainless Steel			Pkg Qty
		Previous Part #	Part #	Price/E	Previous Part #	Part #	Price/E	
1/4"	3/16"	294-0403	2940403C	\$5.24	---	---	---	100
	3/16"	---	2940403CBC¹	8.86	---	---	---	---
	1/4"	294-0404	2940404C	3.03	294-0404SS	2940404SS	\$30.86	100
	1/4"	---	2940404CBC¹	7.47	---	---	---	---
	5/16"	294-0405	2940405C	4.78	---	---	---	100
	5/16"	---	2940405CBC¹	8.49	---	---	---	---
3/8"	3/8"	294-0606	2940606C	3.32	294-0606SS	2940606SS	28.57	50
	3/8"	---	2940606CBC¹	7.86	---	---	---	---
1/2"	1/2"	294-0808	2940808C	4.92	294-0808SS	2940808SS	33.06	50
	1/2"	---	2940808CBC¹	8.80	---	---	---	---
5/8"	5/8"	294-1010	2941010C	8.42	---	---	---	25
	5/8"	---	2941010CBC¹	11.72	---	---	---	---
3/4"	3/4"	294-1212	2941212C	11.29	294-1212SS	2941212SS	37.24	25

¹ brass cap on CBC parts

Push-On Fitting Tool

Features:

- cuts push-on style hose and inserts the fitting
- Built-in cutter slices through 1/4" - 3/4" ID reinforced push-on hose without fraying.
- Clamp hose into tools vice and apply light pressure on handle to drive in the fitting.
- tool has four 7/16" diameter mounting holes for bench mounting
- overall size is 13 1/2" long x 2 3/8" wide x 7" height

Installation Instructions:

1. To cut your hose, retract the handle, place the hose in the cutter area and pull the handle.
2. After cutting the hose to the desired length, place the hose under the cam handle locking it in place with the hose end aligned with the appropriate mark on the label.
3. Place the barbed end of the fitting against the end of the hose and then pull the handle forward to complete the installation.



Size	Part #	Price/E
1/4" - 3/4"	270AT	\$1146.50

! Caution: Push-on fittings will properly grip push-on hose only when pushed all the way in, with the cut end of the hose completely concealed by the plastic cap.

Push-On Fitting Insertion Tool Blade

Description	Part #	Price/E
replacement blade	270AT-RPLBlade	\$193.50

Hose Assembly Tool

- installs 1/4", 5/16" and 3/8" hose fittings
- lightweight, portable, comfortable cushioned grip
- economical



Part #	Price/E
HHCI	\$222.00

Yellow Lok-on Caps

- **intended for use with Lok-On (push-on style) hose only**
- No hose clamps or ferrules are needed for installation
- Properly grips push-on hose only when pushed all the way in, with the cut end of the hose completely concealed by the plastic cap.



Hose ID	Plastic		Pkg Qty
	Part #	Price/E	
1/4"	2720400W	\$0.14	100
5/16"	2720500W	0.13	100
3/8"	2720600W	0.18	100
1/2"	2720800W	0.22	100
5/8"	2721000W	0.23	50
3/4"	2721200W	0.29	50
1"	2721600W	4.31	25



- Sold in package quantities only.

Reusable Male Fittings

Application:

- recommended for low pressure air hose applications

Features:

- maximum working pressure: **250 PSI** at ambient temperature **70°F (21°C)**
- durable, easily repaired hose connection
- caution: check hose OD and ID accurately before ordering 

Hose ID	Hose OD	Male NPTF	Brass			Pkg Qty
			Previous Part #	Part #	Price/E	
1/4"	1/2"	1/8"	BN21RU50	1834082K	\$7.96	100
	9/16"	1/8"	BN21RU56	1834092K	8.96	100
	5/8"	1/8"	BN21RU62	1834102K	9.27	100
	1/2"	1/4"	BN22RU50	1834084K	6.07	50
	9/16"	1/4"	BN22RU56	1834094K	6.57	50
	5/8"	1/4"	BN22RU62	1834104K	6.81	50
	1/2"	3/8"	BN23RU50	1834086K	8.96	50
	9/16"	3/8"	BN23RU56	1834096K	9.46	50
	5/8"	3/8"	BN23RU62	1834106K	9.70	50
5/16"	9/16"	1/4"	BN252RU56	1835094K	8.92	50
	5/8"	1/4"	BN252RU62	1835104K	8.55	50
	11/16"	1/4"	BN252RU68	1835114K	9.61	50
	9/16"	3/8"	BN253RU56	1835096K	13.21	50
	5/8"	3/8"	BN253RU62	1835106K	12.52	50
	11/16"	3/8"	BN253RU68	1835116K	11.97	50
3/8"	5/8"	1/4"	BN32RU62	1836104K	7.08	50
	11/16"	1/4"	BN32RU68	1836114K	7.72	50
	3/4"	1/4"	BN32RU75	1836124K	7.25	50
	5/8"	3/8"	BN33RU62	1836106K	7.75	50
	11/16"	3/8"	BN33RU68	1836116K	8.39	50
	3/4"	3/8"	BN33RU75	1836126K	7.92	50
	5/8"	1/2"	BN34RU62	1836108K	11.42	50
	11/16"	1/2"	BN34RU68	1836118K	12.06	50
	3/4"	1/2"	BN34RU75	1836128K	11.59	50
1/2"	7/8"	1/4"	BN42RU87	1838144K	15.92	25
	15/16"	1/4"	BN42RU93	1838154K	17.09	25
	1"	1/4"	BN42RU99	1838164K	18.30	25
	7/8"	3/8"	BN43RU87	1838146K	15.74	25
	15/16"	3/8"	BN43RU93	1838156K	16.91	25
	1"	3/8"	BN43RU99	1838166K	18.12	25
	7/8"	1/2"	BN44RU87	1838148K	15.80	20
	15/16"	1/2"	BN44RU93	1838158K	17.33	20
	1"	1/2"	BN44RU99	1838168K	18.53	20



Hose ID	Hose OD	Male NPT	303 Stainless Steel			Pkg Qty
			Previous Part #	Part #	Price/E	
1/4"	1/2"	1/8"	BN21RU50SS	1834082KSS	\$64.45	100
	9/16"	1/8"	BN21RU56SS	1834092KSS	63.63	100
	5/8"	1/8"	BN21RU62SS	1834102KSS	63.80	100
	1/2"	1/4"	BN22RU50SS	1834084KSS	69.30	50
	9/16"	1/4"	BN22RU56SS	1834094KSS	68.48	50
	5/8"	1/4"	BN22RU62SS	1834104KSS	68.65	50
5/16"	9/16"	1/4"	BN252RU56SS	1835094KSS	67.70	50
	5/8"	1/4"	BN252RU62SS	1835104KSS	67.54	50
3/8"	5/8"	1/4"	BN32RU62SS	1836104KSS	71.77	50
	11/16"	1/4"	BN32RU68SS	1836114KSS	71.70	50
	3/4"	1/4"	BN32RU75SS	1836124KSS	71.48	50
	5/8"	3/8"	BN33RU62SS	1836106KSS	71.35	50
	11/16"	3/8"	BN33RU68SS	1836116KSS	71.64	50
	3/4"	3/8"	BN33RU75SS	1836126KSS	71.43	50
	7/8"	3/8"	BN43RU87SS	1838146KSS	91.41	25
	15/16"	3/8"	BN43RU93SS	1838156KSS	94.91	25
	7/8"	1/2"	BN44RU87SS	1838148KSS	103.60	20
	15/16"	1/2"	BN44RU93SS	1838158KSS	103.60	20



Reusable Female Swivel Stems

Hose ID	Female NPSM	Brass		Optional Qty
		Part #	Price/E	
1/4"	1/4"-18	1840404A	\$6.10	50
	3/8"-18	1840406A	10.80	50
5/16"	1/4"-18	1840504A	7.23	50
3/8"	1/4"-18	1840604A	7.00	50
	3/8"-18	1840606A	8.60	50
1/2"	1/2"-14	1840808A	10.75	25

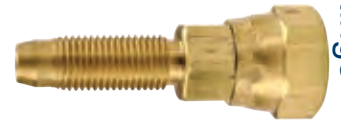

Industrial Hose Fittings

Reusable Female Swivels

Hose ID	Hose OD	Female NPSM	Brass			Optional Qty
			Previous Part #	Part #	Price/E	
1/4"	1/2"	1/4"	185-4084	1854084K	\$8.55	50
	9/16"	1/4"	185-4094	1854094K	9.65	50
	5/8"	1/4"	185-4104	1854104K	9.96	50
	1/2"	3/8"	185-4086	1854086K	13.08	50
	9/16"	3/8"	185-4096	1854096K	13.71	50
	5/8"	3/8"	185-4106	1854106K	13.91	50
5/16"	9/16"	1/4"	185-5094	1855094K	11.49	50
	5/8"	1/4"	185-5104	1855104K	10.50	50
	11/16"	1/4"	185-5114	1855114K	12.17	50
3/8"	5/8"	1/4"	185-6104	1856104K	10.32	50
	11/16"	1/4"	185-6114	1856114K	10.97	50
	3/4"	1/4"	185-6124	1856124K	10.50	50
	5/8"	3/8"	185-6106	1856106K	11.84	50
	11/16"	3/8"	185-6116	1856116K	12.49	50
	3/4"	3/8"	185-6126	1856126K	12.79	50
1/2"	7/8"	1/2"	185-8148	1858148K	18.45	20
	15/16"	1/2"	185-8158	1858158K	19.62	20
	1"	1/2"	185-8168	1858168K	20.83	20



Reusable Splicer Stems

Hose ID	Brass		Optional Qty
	Part #	Price/E	
1/4"	1860404S	\$5.15	100
3/8"	1860606S	4.95	50



Reusable Hose Splicers

Hose ID	Hose OD	Brass			Optional Qty
		Previous Part #	Part #	Price/E	
1/4"	1/2"	187-0408	1870408K	\$11.45	50
	9/16"	187-0409	1870409K	11.45	50
	5/8"	187-0410	1870410K	13.54	50
3/8"	5/8"	187-0610	1870610K	12.25	25
	11/16"	187-0611	1870611K	12.88	25
	3/4"	187-0612	1870612K	12.75	25



Reusable Fittings

Reusable Ferrules

Industrial Hose
Fittings



Hose ID	Hose OD	Brass		303 Stainless Steel		
		Part #	Price/E	Part #	Price/E	Opt Qty
1/4"	1/2"	1800408F	\$2.79	1800408FSS	\$35.20	100
	9/16"	1800409F	3.95	1800409FSS	34.37	50
	5/8"	1800410F	4.19	1800410FSS	34.55	50
5/16"	9/16"	1800509F	5.12	1800509FSS	35.62	100
	5/8"	1800510F	3.96	1800510FSS	35.46	50
	11/16"	1800511F	5.85	---	---	50
3/8"	5/8"	1800610F	3.73	1800610FSS	35.71	50
	11/16"	1800611F	4.40	1800611FSS	36.00	50
	3/4"	1800612F	3.91	1800612FSS	35.80	50
1/2"	7/8"	1800814F	8.42	1800814FSS	52.37	25
	15/16"	1800815F	9.63	1800815FSS	52.37	25
	1"	1800816F	11.89	---	---	20

Reusable Male Stems

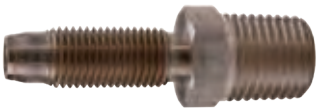
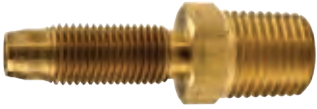

Hose ID	Male NPTF Thread ¹	Brass		303 Stainless Steel ¹		
		Part #	Price/E	Part #	Price/E	Opt Qty
1/4"	1/8"	1820402S	\$6.14	1820402SS	\$29.27	100
	1/4"	1820404S	3.51	1820404SS	34.12	100
	3/8"	1820406S	6.52	---	---	50
5/16"	1/4"	1820504S	4.61	1820504SS	32.10	50
	3/8"	1820506S	9.73	---	---	50
3/8"	1/4"	1820604S	3.63	1820604SS	35.70	100
	3/8"	1820606S	4.32	1820606SS	35.64	50
	1/2"	1820608S	8.14	---	---	25
1/2"	1/4"	1820804S	8.12	---	---	50
	3/8"	1820806S	7.95	1820806SS	42.55	50
	1/2"	1820808S	8.37	1820808SS	50.90	25

¹ stainless steel parts have NPT threads

Standard Shank Fittings

GHT Complete Couplings with Hex Nut

Hose Size	Brass			Lead Free Brass ²		303 Stainless		
	Previous Part #	Part #	Price/E	Part #	Price/E	Previous Part #	Part #	Price/E
3/8"	BC73	5920606K	\$13.17	---	---	---	---	---
1/2"	BC74	5920808K	13.17	5920808KLF	\$31.09	SSC74	5920808KSS	\$162.80
5/8"	BC75	5921010K	13.40	5921010KLF	31.09	SSC75	5921010KSS	162.70
3/4"	BC76	5921212K	13.70	5921212KLF	31.09	SSC76	5921212KSS	162.70
1"	BC78	5921612K	20.83	---	---	---	---	---
1"	BS808	5921616K ¹	26.85	---	---	---	---	---

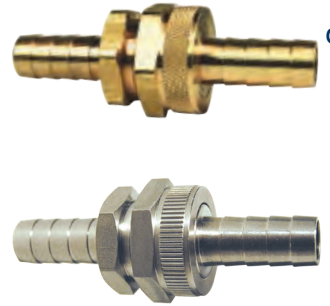

Industrial Hose Fittings

¹ NPSH thread

² Lead free brass <=0.25% lead; Alloy CA2745; Alloy C46400

GHT Female Fittings with Swivel Nut

Hose Size	Brass			Lead Free Brass ²		303 Stainless			Pkg Qty
	Previous Part #	Part #	Price/E	Part #	Price/E	Previous Part #	Part #	Price/E	
3/8"	BCF73	5910612C	\$7.11	---	---	---	---	---	25
1/2"	BCF74	5910812C	7.11	---	---	SSCF74	5910812SS	\$100.48	25
	---	---	---	5910812CLF	\$17.57	---	---	---	---
5/8"	BCF75	5911012C	7.11	---	---	SSCF75	5911012SS	100.48	25
	---	---	---	5911012CLF	17.57	---	---	---	---
3/4"	BCF76	5911212C	7.42	---	---	SSCF76	5911212SS	100.48	25
	---	---	---	5911212CLF	17.57	---	---	---	---
1"	BCF78	5911612C	12.21	---	---	---	---	---	10
	BS848	5911616C ^{1,3}	13.14	---	---	---	---	---	10



¹ NPSH thread

² Lead free brass <=0.25% lead; Alloy CA2745; Alloy C46400

³ washer included, part # **5911616W** on page E-47

• SBR black rubber washer part # **5911212W** included found on page E-47

GHT Male Fittings

Hose Size	Brass			Lead Free Brass ²		303 Stainless			Pkg Qty
	Previous Part #	Part #	Price/E	Part #	Price/E	Previous Part #	Part #	Price/E	
3/8"	BCM73	5900612C	\$6.75	---	---	---	---	---	25
1/2"	BCM74	5900812C	6.59	---	---	SSCM74	5900812SS	\$61.83	25
	---	---	---	5900812CLF	\$15.08	---	---	---	---
5/8"	BCM75	5901012C	6.81	---	---	SSCM75	5901012SS	61.66	25
	---	---	---	5901012CLF	15.08	---	---	---	---
3/4"	BCM76	5901212C	6.81	---	---	SSCM76	5901212SS	61.66	25
	---	---	---	5901212CLF	15.08	---	---	---	---
1"	BCM78	5901612C	8.95	---	---	---	---	---	10
	BS818	5901616C ¹	14.25	---	---	---	---	---	---



¹ NPSH thread

² Lead free brass <=0.25% lead; Alloy CA2745; Alloy C46400

Short Shank Fittings

- use with washers on page E-47



GHT Complete Couplings with Hex Nut

Hose Size	Brass		
	Previous Part #	Part #	Price/E
1/2"	HNBGH74	5890808K	\$12.60
5/8"	HNBGH75	5891010K	13.12
3/4"	HNBGH76	5891212K	13.00



GHT Complete Couplings with Round Nut

Hose Size	Brass		
	Previous Part #	Part #	Price/E
1/2"	BGH74	5870808K	\$14.04
5/8"	BGH75	5871010K	14.04
3/4"	BGH76	5871212K	14.12

GHT Female Couplings with Round Nut

Hose Size	Shank Length	Brass		Price/E
		Previous Part #	Part #	
1/2"	1"	BGHF74	5860812C	\$7.81
5/8"	1"	BGHF75	5861012C	7.81
3/4"	1"	BGHF76	5861212C	7.89

GHT Female Swivels with Hex Nut

Hose Size	Shank Length	Brass		Price/E
		Previous Part #	Part #	
1/2"	1"	HNBGHF74	5880812C	\$6.62
5/8"	1"	HNBGHF75	5881012C	6.70
3/4"	1"	HNBGHF76	5881212C	7.05

GHT Male Couplings with Round Nut

Hose Size	Shank Length	Brass		Price/E
		Previous Part #	Part #	
1/2"	1"	BGHM74	5850812C	\$6.48
5/8"	1"	BGHM75	5851012C	6.48
3/4"	1"	BGHM76	5851212C	6.48

Garden Hose Menders



Hose ID	Brass		Price/E
	Previous Part #	Part #	
1/2"	5780808C	1780808C	\$3.36
5/8"	5781010C	1781010C	4.00
3/4"	5781212C	1781212C	5.39
1"	5781616C	1781616C	10.10

Short Shank Couplings with Octagon Nut

- sold in complete sets only

Hose Size	Shank Length	Aluminum	
		Part #	Price/E
3/8"	13/16"	ABC73	\$6.20
1/2"	13/16"	ABC74	6.20
3/4"	1-1/8"	ABC76	6.20



Industrial Hose Fittings

Standard Shank Cast Coupling with Hex Nut

- use with washers on page E-15
- sold in complete sets only

Hose Size	Brass	
	Part #	Price/E
1/2"	CBC74	\$12.60
5/8"	CBC75	12.60
3/4"	CBC76	12.60
1"	CBC88 ¹	21.50



¹ NPSM thread



Long Shank Fittings

Complete Couplings - GHT

Feature:

- extended male GHT, deeper thread



Hose ID	GHT Thread	Plated Steel		Brass		
		Part #	Price/E	Previous Part #	Part #	Price/E
3/8"	3/4"	SLS307	\$30.75	---	---	---
1/2"	1/2"	---	---	---	---	---
1/2"	3/4"	SLS407	27.50	BLS407	5950808K	\$18.90
5/8"	3/4"	SLS507	24.90	BLS507	5951010K	17.93
3/4"	3/4"	SLS607	26.60	BLS607	5951212K	17.99



Female Couplings - GHT



Hose ID	GHT Thread	Plated Steel		Brass			Pkg Qty	Lead Free Brass	
		Part #	Price/E	Previous Part #	Part #	Price/E		Part #	Price/E
3/8"	3/4"	SLS347	\$17.40	---	---	---	---	---	
1/2"	1/2"	---	---	---	---	---	---	---	
1/2"	3/4"	SLS447	16.20	BLS447	5940812C	\$9.48	150	---	
5/8"	3/4"	SLS547	12.50	BLS547	5941012C	9.63	150	---	
3/4"	3/4"	SLS647	13.60	BLS647	5941212C	9.63	150	5941212CLF \$39.19	



Male Couplings - GHT

Feature:

- extended male GHT, deeper thread



Hose ID	GHT Thread	Plated Steel		Brass			Pkg Qty	Lead Free Brass	
		Part #	Price/E	Previous Part #	Part #	Price/E		Part #	Price/E
3/8"	3/4"	SLS317	\$13.35	---	---	---	---	---	
1/2"	1/2"	---	---	---	---	---	---	---	
1/2"	3/4"	SLS417	11.30	BLS417	5930812C	\$9.76	150	---	
5/8"	3/4"	SLS517	12.40	BLS517	5931012C	9.00	150	---	
3/4"	3/4"	SLS617	13.00	BLS617	5931212C	9.06	150	5931212CLF \$68.20	

Spray Hose Fittings

Complete Couplings - GHT

Hose ID	GHT Thread	Plated Steel	
		Part #	Price/E
3/8"	3/4"	SS307	\$25.55
1/2"	3/4"	SS407	23.95
5/8"	3/4"	SS507	27.70
3/4"	3/4"	SS607	37.75

Industrial Hose
Fittings

Female Couplings - GHT

Hose ID	GHT Thread	Plated Steel	
		Part #	Price/E
3/8"	3/4"	SS347	\$14.05
1/2"	3/4"	SS447	12.15
5/8"	3/4"	SS547	13.70
3/4"	3/4"	SS647	24.55



Male Couplings - GHT

Hose ID	GHT Thread	Plated Steel	
		Part #	Price/E
3/8"	3/4"	SS317	\$11.50
1/2"	3/4"	SS417	11.80
5/8"	3/4"	SS517	14.00
3/4"	3/4"	SS617	13.20



GHT Zinc Fittings

Features:

- premium brass and zinc construction for maximum strength and durability
- patented impact resistant clamp design
- non-corroding high grade 410 stainless steel screws will not strip when tightened
- leakproof, reusable
- for use with rubber or plastic hose
- fits all 5/8" and 3/4" hose



Female Hose Fittings

Part #	Price/E	Optional Qty
M5834F	\$14.75	48



Male Hose Fittings

Part #	Price/E	Optional Qty
M5834M	\$13.10	48



Menders

Part #	Price/E	Optional Qty
M5834HM	\$20.50	48

Male Hose x Male Hose x Female Pipe Adapter



Male GH x Male GH x Female NPT	Lead Free Brass	
	Part #	Price/E
3/4" x 3/4" x 1/2"	5091212CLF	\$19.67

Male GHT x Male NPTF Adapters



brass



lead free brass



303 stainless

Male GHT	Male NPTF	Previous Part #	Brass		Lead Free Brass ³		Male Thread	Previous Part #	303 Stainless		Pkg Qty
			Part #	Price/E	Part #	Price/E			Part #	Price/E	
3/4"	3/8"	BA73	5081206C ¹	\$5.52	---	---	---	---	---	---	25
3/4"	1/2"	BA74	5081208C ¹	5.88	5081208CLF	\$18.77	NPT	RA74	5081208SS	\$40.95	25
3/4"	3/4"	---	5081212C ¹	6.71	---	---	NPT	RA776	5081212SS	39.62	25
3/4"	3/4" x 1/2"	BA776	5141212C ^{1,2}	6.37	5141212CLF ²	19.03	NPT	---	5141212SS ²	43.83	25
3/4"	1"	BA78	5081216C ¹	14.48	---	---	---	---	---	---	10

¹ extended male GHT, deeper thread

² has 1/2" female NPT on ID of 3/4" male NPT side

³ Lead free brass <=0.25% lead; Alloy CA2745; Alloy C46400

Male GHT Fittings

Adapters

Male GHT	Male GHT	Brass			Male Thread	303 Stainless			Pkg Qty
		Previous Part #	Part #	Price/E		Previous Part #	Part #	Price/E	
3/4"	3/4"	BA777	5091212C ¹	\$6.03	NPT	RA777	5091212SS	\$37.35	25
3/4"	1" ²	509-1612	5091612C ¹	12.05	---	---	---	---	20



brass



303 stainless

¹ extended male GHT, deeper thread
² NPSH thread

Female NPTF Adapters

Male GHT	Female NPTF	Brass			Lead Free Brass		Pkg Qty
		Previous Part #	Part #	Price/E	Part #	Price/E	
3/4"	1/4"	507-1204 ¹	5071204C	\$4.73	---	---	25
3/4"	3/8"	507-1206 ¹	5071206C	5.07	---	---	25
3/4"	1/2"	BA794 ¹	5071208C	5.09	---	---	25
3/4"	3/4"	BA796 ¹	5071212C	8.06	5071212CLF ^{2,3}	\$20.83	25



brass



303 stainless

Male GHT	Female NPT	303 Stainless			Pkg Qty
		Previous Part #	Part #	Price/E	
3/4"	1/2"	RA794	5071208SS	\$29.55	25
3/4"	3/4"	RA796	5071212SS	49.00	25

¹ extended male GHT, deeper thread
² NPT threads
³ Lead free brass <=0.25% lead; Alloy CA2745; Alloy C46400



Female GHT Fittings

Swivel Adapters



Female x Female	Brass			Optional Qty
	Previous Part #	Part #	Price/E	
3/4" x 3/4"	BA977	5061212C	\$10.13	25
3/4" x 3/4"	---	5061212CLF¹	39.85	---

¹ Lead free brass <=0.25% lead; Alloy CA2745; Alloy C46400

Female GHT Swivel x Female NPTF Adapter



Female GHT x Female NPTF	Brass			Lead Free Brass		303 Stainless			Pkg Qty
	Previous Part #	Part #	Price/E	Part #	Price/E	Previous Part #	Part #	Price/E	
3/4" x 1/2"	BAS974	5021208C	\$8.75	5021208CLF^{1,2}	\$23.52	RAS974	5021208SS²	\$74.84	25
3/4" x 3/4"	BAS976	5021212C	10.63	5021212CLF^{1,2}	33.19	RAS976	5021212SS²	80.33	10

¹ Lead free brass <=0.25% lead; Alloy CA2745; Alloy C46400

² NPT threads

Female GHT Swivel x Male NPTF Adapter



Female GHT	Male NPTF	Brass			Male NPT	303 Stainless			Pkg Qty
		Previous Part #	Part #	Price/E		Previous Part #	Part #	Price/E	
3/4"	1/4"	504-1204	5041204C	\$9.20	---	---	---	---	25
3/4"	3/8"	504-1206	5041206C	9.31	---	---	---	---	25
3/4"	1/2"	504-1208	5041208C	9.16	1/2"	R504-1208	5041208SS	\$86.61	25
3/4"	3/4"	504-1212	5041212C	11.05	3/4"	R504-1212	5041212SS	93.90	20

Female GHT x Male NPTF Adapters



Female GHT	Male Thread NPTF	Brass			Male Thread NPT	303 Stainless			Pkg Qty
		Previous Part #	Part #	Price/E		Previous Part #	Part #	Price/E	
3/4"	3/8"	BMA973	5031206C	\$9.34	---	---	---	---	25
3/4"	1/2"	BMA974	5031208C	8.19	1/2"	RMA974	5031208SS	\$50.04	25
3/4"	3/4"	BMA976	5031212C	10.26	3/4"	RMA976	5031212SS	51.66	25

Rigid Female GHT x Female NPTF Adapter



Female GHT	Male Thread NPTF	Brass			Male Thread NPT	303 Stainless			Pkg Qty
		Previous Part #	Part #	Price/E		Previous Part #	Part #	Price/E	
3/4"	1/8"	BA971	5011202C	\$9.85	---	---	---	---	50
3/4"	1/4"	BA972	5011204C	8.50	---	---	---	---	25
3/4"	3/8"	BA973	5011206C	8.45	---	---	---	---	25
3/4"	1/2"	BA974	5011208C	11.62	1/2"	RA974	5011208SS	\$49.48	25
3/4"	3/4"	BA976	5011212C	10.40	3/4"	RA976	5011212SS	49.28	25

Black GHT Washers

ID	OD	<i>black 80 duro SBR</i>		Optional Qty
		Part #	Price/E	
.63"	1.00"	5911212W	\$0.27	100
.86"	1.27"	5911616W	0.37	100



Garden Hose Filter Washer

Description	<i>FDA black 70a duro PVC</i>			Optional Qty
	Previous Part #	Part #	Price/E	
304 stainless steel mesh, FDA black 70a duro PVC	TVS7-30	5911212F	\$0.82	100



Red Vinyl GHT Washer

Part #	<i>red vinyl</i>		Optional Qty
	Price/E		
TVW7	\$0.10		100



White Rubber GHT Washer

Part #	<i>white rubber (Styrene Butadiene)</i>		Optional Qty
	Price/E		
TRW7	\$0.25		100



Garden Hose Cap

Size	<i>Brass</i>			Optional Qty
	Previous Part #	Part #	Price/E	
¾"	GHC7	5131212C	\$4.42	25



Garden Hose Round Nut with Knurl

Size	<i>Brass</i>	
	Part #	Price/E
¾"	5861012N	\$3.95



Garden Hose Hex Nut with Knurl

Size	<i>Brass</i>	
	Part #	Price/E
¾" GHT	5911212N	\$3.98
1" NPSH	5911616N	7.09



Compression Bibb Faucets



- Features:**
- rough brass finish
 - nozzle end is GHT
 - for water use only

Male NPT Inlet Size	Brass	
	Part #	Price/E
1/2"	35-201-10	\$32.50
3/4"	35-202-10	32.50

Garden Hose Quick Connect Assembly



- Features:**
- easy push-pull ring for long lasting and quick hose attachments
 - maximum operating pressure: **150 PSI** at ambient temperature **70°F (21°C)**
 - maximum temperature **140°F (60°C)**

Description	Brass			303 Stainless Steel		
	Previous Part #	Part #	Price/E	Previous Part #	Part #	Price/E
complete assembly	DGH7	500QCK	\$14.09	DGH7SS	500QCKSS	\$83.60
complete valved assembly	DGH7V	500QCKV	18.12	---	---	---

Garden Hose Quick Connect Female Couplers



Description	Brass			303 Stainless Steel		
	Previous Part #	Part #	Price/E	Previous Part #	Part #	Price/E
coupler	DGH7C	500QCF	\$10.00	DGH7CSS	500QCFSS	\$57.55
valved coupler-water shutoff	DGH7CV	500QCFV	14.20	---	---	---

Replacement Parts

Description	Part #	Price/E
replacement rubber seal gasket for 500QCFV (DGH7CV)	500QCFVSG	\$0.77
replacement NBR O-ring for 500QCFV (DGH7CV)	500QCFVOR	0.77

Garden Hose Quick Connect Replacement Seal for 500QCF



Nitrile Butadiene Rubber		
Previous Part #	Part #	Price/E
DGHW7	500QCSG	\$0.77

Garden Hose Quick Connect Male Plugs



Description	Brass			303 Stainless Steel		
	Previous Part #	Part #	Price/E	Previous Part #	Part #	Price/E
male plug	DGH7P	500QCM	\$4.64	DGH7PSS	500QCMSS	\$26.05

Straight GHT Valve

Features:

- powder-coated zinc shut-off valve
- maximum temperature: **160°F (71°C)** (hot water)
- recommended usage: **100°F (38°C)**
- working pressure: **60 PSI**

Part #	Price/E
GHV	\$12.20

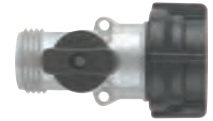

GHT Ball Valve

Features:

- forged brass
- maximum temperature: **140°F (60°C)** (hot water)
- working pressure: **100 PSI**

Part #	Price/E
500GHV	\$17.44



GHT Twin Valve

Features:

- powder-coated zinc with twin shut-off valves
- maximum temperature: **160°F (71°C)** (hot water)
- recommended usage: **100°F (38°C)**
- working pressure: **60 PSI**

Part #	Price/E
GHYV	\$17.10



Garden Hose Y Valve

Features:

- forged brass
- double Y valve, swivel inlet - with Higbie cut threads (capped) to prevent cross threading
- maximum temperature: **140°F (60°C)** (hot water)
- working pressure: **100 PSI**

Part #	Price/E
500GHY	\$36.97



Garden Hose Y Coupler

Features:

- nickel plated brass
- maximum working pressure: **150 PSI**
- maximum temperature: **195°F (90.5°C)**

Part #	Price/E
500YC	\$12.63



GHT Y

Features:

- powder-coated zinc with twin outlet
- includes one end cap
- maximum temperature: **160°F (71°C)** (hot water)
- recommended usage: **100°F (38°C)**
- working pressure: **60 PSI**

Part #	Price/E
GHY	\$9.75



GHT 4-Valve Manifold

**Features:**

- forged brass body, stainless steel balls, PTFE seats
- swivel inlet
- maximum temperature: **120°F (49°C)**
- maximum operating pressure: **100 PSI**

Part #	Price/E
500GH4VBK	\$64.90

GHT Back Flow Preventer

**Features:**

- brass extruded stock
- maximum operating pressure: **125 PSI**
- temperature range: **33°F to 180°F (.5°C to 82°C)**

Materials:

- gasket: EPDM
- components: stainless steel

Part #	Price/E
500BFP	\$26.20

Radiator Bibb

**Feature:**

- ¼" female pipe thread connection

Material:

- vinyl spout

Part #	Price/E
8013	\$30.20

Garden Hose Gooseneck

**Features:**

- angles hose away from hose bibb
- recommended usage: **100°F (38°C)**
- working pressure: **60 PSI**

Powder Coated Zinc Part #	Price/E
GHGN	\$14.10

Tuff-Lite™ Hose Shank x Male NPT Insert

Nylon Features:

- Nylon fittings should not be used with acid-based fertilizers, bromine, chlorine, fluorine, hydrochloric acid, iodine, nitric acid, phosphoric acid, sulfuric acid or xylene.
- nylon should not be used with compressed gas 
- fittings are white

Polypropylene Features:

- Polypropylene fittings should not be used with aromatic hydrocarbons, carbon tetra-chloride, gasoline, hexane, kerosene, nitric acid, sodium hydrochlorite, toluene, trichloroethylene or xylene.
- polypropylene should not be used with compressed gas 
- fittings are black

Hose Size	Male NPT	Nylon		Pkg Qty	Polypropylene		Pkg Qty
		Part #	Price/E		Part #	Price/E	
1/4"	1/8"	TN21	\$0.68	50	PPN21	\$0.84	50
	1/4"	TN22	0.70	50	PPN22	0.82	50
	3/8"	TN23	0.76	50	PPN23	0.85	50
	1/2"	TN24	0.87	50	PPN24	0.88	50
	3/4"	TN26	0.91	50	---	---	---
	1"	TN28	1.40	50	---	---	---
5/16"	1/4"	TN252	0.70	50	---	---	---
3/8"	1/8"	TN31	0.80	50	PPN31	0.84	50
	1/4"	TN32	0.88	50	PPN32	0.81	50
	3/8"	TN33	0.92	50	PPN33	0.82	50
	1/2"	TN34	1.00	50	PPN34	0.95	50
	3/4"	TN36	1.10	50	PPN36	0.90	50
1/2"	1/8"	TN41	0.92	50	---	---	---
	1/4"	TN42	0.77	50	PPN42	0.84	50
	3/8"	TN43	0.79	50	PPN43	0.90	50
	1/2"	TN44	0.91	50	PPN44	0.73	50
	3/4"	TN46	1.05	50	PPN46	1.10	50
5/8"	3/8"	TN53	0.87	50	---	---	---
	1/2"	TN54	0.94	50	PPN54	0.94	50
	3/4"	TN56	1.10	50	PPN56	1.15	50
3/4"	3/8"	TN63	0.83	50	---	---	---
	1/2"	TN64	1.07	50	PPN64	1.00	50
	3/4"	TN66	1.17	50	PPN66	0.93	50
	1"	TN68	1.37	25	PPN68	1.40	25
1"	3/4"	TN86	1.30	25	PPN86	1.30	25
	1"	TN88	1.56	25	PPN88	1.49	25
1 1/4"	1"	TN158	2.35	15	---	---	---
	1 1/4"	TN150	3.80	10	PPN150	3.11	10
	1 1/2"	TN1520	4.10	10	---	---	---
1 1/2"	1 1/4"	TN2015	3.95	10	---	---	---
	1 1/2"	TN200	4.10	10	PPN200	3.20	10
2"	2"	TN250	6.05	5	PPN250	4.55	5

- sold in package quantities only



nylon



polypropylene



Hose Shank x Male NPT Inserts

Size	Nylon		Pkg Qty	Polypropylene		Pkg Qty
	Part #	Price/E		Part #	Price/E	
1 1/4"	THN15	\$6.90	25	---	---	---
1 1/2"	THN20	7.50	25	HB150	\$4.85	25
2"	THN25	11.40	20	HB200	6.25	24
3"	THN35	26.00	10	HB300	17.85	10
4"	---	---	---	HB400	38.75	---



nylon



polypropylene

Tuff-Lite™ Hose Shank x Female NPT Insert

Features:

- Nylon fittings should not be used with acid-based fertilizers, bromine, chlorine, fluorine, hydrochloric acid, iodine, nitric acid, phosphoric acid, sulfuric acid or xylene.
- nylon should not be used with compressed gas 



Hose Size	Female NPT	Nylon	
		Part #	Price/E
1/4"	1/4"	TFS22	\$3.30
1/4"	1/2"	TFS42	3.45
1/2"	1/2"	TFS44	3.20
3/4"	3/4"	TFS66	3.80

Tuff-Lite™ Female 45°SAE/37°JIC Swivel x Hose Barb

Feature:

- ball seat type



Hose Size	Female NPSM	Nylon	
		Part #	Price/E
1/4"	1/4"	TF22	\$0.92
3/8"	3/8"	TF33	1.07

Tuff-Lite™ Short Shank x Female NPSM Coupling

- sold in package quantities only
- shipped with a red vinyl washer (**TVW7**), replacement washers on page E-47



Hose Shank	Female NPSM	Nylon		Pkg Qty
		Part #	Price/E	
1/4"	3/4"	TCF62	\$1.55	50
3/8"	3/4"	TCF63	1.55	50
1/2"	3/4"	TCF64	1.60	50
5/8"	3/4"	TCF65	1.65	50
3/4"	3/4"	TCF66	1.65	50

Tuff-Lite™ 90° Hose Barb Elbow x Male NPT

Industrial Hose Fittings

Hose Size	Male NPT	Nylon		Pkg Qty
		Part #	Price/E	
1/4"	1/8"	TLS21	\$0.82	50
	1/4"	TLS22	0.91	50
	3/8"	TLS23	1.17	50
3/8"	1/4"	TLS31	0.87	50
	1/4"	TLS32	0.91	50
	3/8"	TLS33	1.17	50
	1/2"	TLS34	1.36	50
	3/4"	TLS36	1.46	50
1/2"	1/4"	TLS42	1.17	50
	3/8"	TLS43	1.17	50
	1/2"	TLS44	1.36	50
	3/4"	TLS46	1.46	25
	1"	TLS48	1.90	25
5/8"	3/8"	TLS53	1.36	25
	1/2"	TLS54	1.46	25
	3/4"	TLS56	1.55	25
	1"	TLS58	1.65	25
3/4"	3/8"	TLS63	1.65	25
	1/2"	TLS64	1.55	25
	3/4"	TLS66	1.65	25
	1"	TLS68	1.72	15
1"	3/4"	TLS86	1.65	15
	1"	TLS88	2.61	15



• sold in package quantities only.

Tuff-Lite™ 90° Hose Barb Elbow x Female NPT

Hose Size	Female NPT	Nylon	
		Part #	Price/E
1/2"	1/2"	TLFS44	\$2.95
1/2"	3/4"	TLFS64	3.55
3/4"	3/4"	TLFS66	3.60



Tuff-Lite™ Hose Barb x 90° Hose Barb Elbow

Hose Size	Nylon		Pkg Qty	Polypropylene		Pkg Qty
	Part #	Price/E		Part #	Price #	
1/4"	TLSS22	\$1.17	50	PPLSS22	\$1.25	50
3/8"	TLSS33	1.21	50	PPLSS33	1.25	50
1/2"	TLSS44	1.35	50	PPLSS44	1.25	50
3/4"	TLSS66	1.42	50	PPLSS66	1.55	50



• sold in package quantities only

Tuff-Lite™ Hose Run x Male NPT Branch Tee



Hose Size	Male NPT	Nylon		Pkg Qty
		Part #	Price/E	
1/4"	1/4"	TSST222	\$1.23	50
3/8"	3/8"	TSST333	1.35	50
1/2"	1/2"	TSST444	1.52	25
3/4"	3/4"	TSST666	1.70	25

- sold in package quantities only

Tuff-Lite™ Hose Run x Hose Branch Tee



Hose Size	Nylon		Pkg Qty
	Part #	Price/E	
1/4"	TSSS222	\$1.17	50
3/8"	TSSS333	1.21	50
1/2"	TSSS444	1.35	50
3/4"	TSSS666	1.42	25

- sold in package quantities only

Tuff-Lite™ Menders

Feature:

- maximum working temperature: 150°F (66°C)

Size	Nylon			Polypropylene		Pkg Qty
	Part #	Price/E	Pkg Qty	Part #	Price #	
1/4"	TM2 ¹	\$0.82	50	PPM2	\$0.77	50
5/16"	TM25 ¹	0.83	50	---	---	---
3/8"	TM3 ¹	0.85	50	PPM3	0.79	50
1/2"	TM4 ¹	1.10	50	PPM4	0.92	50
5/8"	TM5 ¹	1.50	50	PPM5	1.00	50
3/4"	TM6 ¹	1.50	50	PPM6	1.20	50
1"	TM8 ¹	1.82	25	PPM8	1.47	50
1 1/4"	TM16	4.55	---	---	---	---
1 1/2"	TM21	7.45	---	---	---	---
2"	TM26	10.30	---	---	---	---
4"	TM46	60.50	---	---	---	---
6"	TM66	85.10	---	---	---	---

- sold in package quantities only



nylon



polypropylene

Tuff-Lite™ Short Shank Female GHT Couplings

- shipped with a red vinyl washer (**TVW7**), replacement washers on page E-47

Hose Shank	Thread Size	Nylon		Polypropylene	
		Part #	Price/E	Part #	Price/E
1/4"	3/4" GHT	TCF72	\$1.85	PPCF72	\$1.90
3/8"	3/4" GHT	TCF73	1.85	PPCF73	1.90
1/2"	3/4" GHT	TCF74	1.90	PPCF74	1.90
5/8"	3/4" GHT	TCF75	1.95	PPCF75	1.90
3/4"	3/4" GHT	TCF76	1.95	PPCF76	2.00



polypropylene



nylon

Industrial Hose Fittings

Tuff-Lite™ Short Shank Male GHT Couplings

Hose Shank	Thread Size	Nylon		Polypropylene	
		Part #	Price/E	Part #	Price/E
1/4"	3/4" GHT	TCM72	\$0.95	---	---
3/8"	3/4" GHT	TCM73	1.00	PPCM73	\$1.10
1/2"	3/4" GHT	TCM74	1.05	PPCM74	1.15
5/8"	3/4" GHT	TCM75	1.05	PPCM75	1.15
3/4"	3/4" GHT	TCM76	1.05	PPCM76	1.20



polypropylene



nylon

Tuff-Lite™ Male GHT x Female NPT Adapter

Female NPT	Nylon			Polypropylene		
	Part #	Price/E	Pkg Qty	Part #	Price/E	Pkg Qty
1/4"	TA792	\$1.45	50	PPA792	\$2.95	50
3/8"	TA793	1.50	50	---	---	--
1/2"	TA794	1.51	50	PPA794	2.85	50
3/4"	TA796	1.60	50	PPA796	2.98	25



polypropylene



nylon

- sold in package quantities only

Tuff-Lite™ Female GHT x Male NPT Adapter

Male NPT	Nylon		Pkg Qty
	Part #	Price/E	
1/4"	TA972	\$1.46	50
3/8"	TA973	1.50	50
1/2"	TA974	1.53	50
3/4"	TA976	1.55	50



- sold in package quantities only

Tuff-Lite™ Female GHT x Female NPT Adapter



Female NPT	Nylon		Pkg Qty
	Part #	Price/E	
1/2"	TA974F	\$4.30	50
3/4"	TA976F	6.90	50

- sold in package quantities only

Tuff-Lite™ Male GHT x Male NPT Adapter



polypropylene



nylon

Male NPT	Nylon			Polypropylene		Pkg Qty
	Part #	Price/E	Pkg Qty	Part #	Price/E	
1/4"	TA772	\$0.95	50	---	---	---
3/8"	TA773	1.05	50	PPA773	\$1.15	50
1/2"	TA774	1.15	50	PPA774	1.15	50
3/4"	TA776	1.15	50	PPA776	1.15	50
1"	TA778	1.60	25	---	---	---

- sold in package quantities only

Tuff-Lite™ Male GHT x 90° Hose Barb Elbow



Hose Size	Nylon		Pkg Qty
	Part #	Price/E	
3/8"	TLS37	\$2.85	50
1/2"	TLS47	2.45	25
5/8"	TLS57	2.95	25
3/4"	TLS67	3.55	50

- sold in package quantities only

Tuff-Lite™ GHT x Male NPT Elbow



Male NPT	Nylon		Pkg Qty
	Part #	Price/E	
3/8"	TLT73	\$1.66	25
1/2"	TLT74	1.65	25
3/4"	TLT76	1.70	25

- sold in package quantities only

Tuff-Lite™ Push-On Hose Shank x Male NPT Insert

Feature:

- No clamps are needed when these fittings are used with push-on hose.

Hose Size	Male NPT	Nylon		Pkg Qty
		Part #	Price/E	
1/4"	1/8"	TPN21	\$0.70	50
	1/4"	TPN22	0.72	50
	3/8"	TPN23	0.78	50
3/8"	1/4"	TPN32	0.74	50
	3/8"	TPN33	0.79	50
	1/2"	TPN34	0.93	50
1/2"	3/8"	TPN43	1.15	50
	1/2"	TPN44	1.15	50
	3/4"	TPN46	1.20	50



Industrial Hose Fittings

- sold in package quantities only

Tuff-Lite™ Push-On Hose Shank x Female NPT Insert

Feature:

- No clamps are needed when these fittings are used with push-on hose.

Hose Size	Female NPT	Nylon		Pkg Qty
		Part #	Price/E	
1/4"	1/4"	TPF22	\$1.02	50
3/8"	1/4"	TPF32	1.26	50
	3/8"	TPF33	1.26	50
1/2"	3/8"	TPF43	1.15	50
	1/2"	TPF44	1.32	50



- sold in package quantities only

Tuff-Lite™ Push-On Hose Menders

Feature:

- no clamps needed when used with push-on hose

Size	Nylon		Pkg Qty
	Part #	Price/E	
1/4"	TPM2	\$0.65	50
3/8"	TPM3	0.71	50
1/2"	TPM4	0.87	50



- sold in package quantities only

Application:

- used primarily on irrigation and suction lines

Features:

- hot dipped, galvanized
- has a double pin locking lever for smooth closing action
- Type A Agri-Lock style locks on female style
- Each coupler is equipped with a safety pin to prevent accidental openings.
- *These fittings are not recommended for chemicals or any hazardous type materials where the possibility of leakage would result in health or environmental concerns. Consult Dixon® for recommendations.*



Type A Female with Hose Shank



10"

Features:

- supplied with gasket

Size	Galvanized Steel	
	Part #	Price/E
10"	FC21210	\$346.25
12"	FC21212 ¹	630.00

¹ 12" supplied with M20412 lever assist bar found on page E-61

Type A Female with Machined Hose Shank



12"

Features:

- Dixon® combination nipple style hose shank machined from Schedule 40 pipe
- recommended for use with steel King Crimp™ sleeves
- supplied with gasket

Size	Galvanized Steel	
	Part #	Price/E
10"	FC21210ST100	\$779.00
12"	FC21212ST120 ¹	1075.00

¹ 12" supplied with M20412 lever assist bar found on page E-61

Type A Female with 150# ASA Flange



12"

Feature:

- supplied with gasket

Size	Galvanized Steel	
	Part #	Price/E
10"	FC22310	\$875.50
12"	FC22312 ¹	1257.00

¹ 12" supplied with M20412 lever assist bar found on page E-61

- For flange dimensions, diagrams and additional information please reference dixonvalve.com.

Type A Male with Hose Shank

Size	Galvanized Steel	
	Part #	Price/E
10"	MC21110	\$352.80
12"	MC21112	551.50



Industrial Hose Fittings

Type A Male with Machined Hose Shank

Features:

- Dixon® combination nipple style hose shank machined from Schedule 40 pipe
- recommended for use with steel King Crimp™ sleeves

Size	Galvanized Steel	
	Part #	Price/E
10"	MC21110ST100	\$765.00
12"	MC21112ST120	877.00



Type A Male with 150# ASA Flange

Size	Galvanized Steel	
	Part #	Price/E
10"	MC22210	\$891.25
12"	MC22212	1216.80

- For flange dimensions, diagrams and additional information please reference dixonvalve.com.



Type A Male x Female 90° Elbows



- Feature:**
- supplied with gasket

Size	Galvanized Steel	
	Part #	Price/E
10"	EL21510-90	\$806.25
12"	EL21512-90 ¹	1265.75

¹ 12" supplied with M20412 lever assist bar on page E-61

Type A Female for Welding to Pipe



Size	Unplated Steel	
	Part #	Price/E
10"	20410	\$143.00
12"	20412	300.00

Type A Males with Ring for Welding



Size	Unplated Steel	
	Part #	Price/E
10"	21010	\$132.00
12"	21012	235.80

Type A Female Plugs



- Feature:**
- supplied with gasket

Size	Galvanized Steel	
	Part #	Price/E
10"	FP20910	\$295.50
12"	FP20912 ¹	628.10

¹ 12" supplied with M20412 lever assist bar on page E-61

Type A Male Plugs with Ring

Size	Galvanized Steel	
	Part #	Price/E
10"	MP21010	\$267.50
12"	MP21012	479.00



Industrial Hose Fittings

Type A Gaskets

Size	Rubber		EPDM	
	Part #	Price/E	Part #	Price/E
10"	RG20510	\$26.25	RG20610	\$58.50
12"	RG20512	29.50	RG20612	66.50



Type A Lever Assist Bar

Size	Galvanized Steel	
	Part #	Price/E
12"	M20412	\$16.75

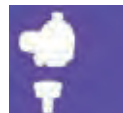

Type A Quick Connect Safety Pin

Size	Galvanized Steel	
	Part #	Price/E
12"	SP290	\$14.50



Application:

- used primarily on irrigation and suction lines

Features:

- hot dipped, galvanized
- has a double pin locking lever for smooth closing action
- Type B (*Bauer style*) locks on the male side
- Each coupler is equipped with a safety pin to prevent accidental openings.
- *These fittings are not recommended for chemicals or any hazardous type materials where the possibility of leakage would result in health or environmental concerns. Consult Dixon® for recommendations.*



Type B Male x Hose Shank



Size	Galvanized Steel	
	Part #	Price/E
2"	MC3092	\$43.50
3"	MC3093	69.50
4"	MC3094	124.90
6"	MC3096	219.25
8"	MC3098	422.00
10"	MC30910 ¹	860.50
12"	MC30912 ¹	1054.00

¹ 10" and 12" supplied with ACB304 lever assist bar on page E-66

Type B Male with Male NPT



Size	Galvanized Steel	
	Part #	Price/E
2"	MCM3112	\$60.50
3"	MCM3113	89.00
4"	MCM3114	149.75
6"	MCM3116	270.50
8"	MCM3118	525.00

Type B Female x Hose Shank

Feature:

- supplied with gasket



Size	Galvanized Steel	
	Part #	Price/E
2"	FC3102	\$24.50
3"	FC3103	33.00
4"	FC3104	57.00
6"	FC3106	97.50
8"	FC3108	185.60
10"	FC31010	376.75
12"	FC31012	483.70

Type B Female with Male NPT

Feature:

- supplied with gasket



Size	Galvanized Steel	
	Part #	Price/E
2"	FCM3122	\$40.50
3"	FCM3123	51.50
4"	FCM3124	83.25
6"	FCM3126	142.50
8"	FCM3128	293.00

Type B Male with Machined Hose Shank

Features:

- Dixon® combination nipple style hose shank machined from Schedule 40 pipe
- recommended for use with steel King Crimp™ sleeves

Size	Galvanized Steel	
	Part #	Price/E
2"	MC3092ST25	\$99.65
3"	MC3093ST35	161.60
4"	MC3094ST40	197.00
6"	MC3096ST60	394.00
8"	MC3098ST80	655.00



Industrial Hose Fittings

Type B Male x 150# ASA Flange

Size	Galvanized Steel	
	Part #	Price/E
4"	MC3134	\$228.00
6"	MC3136	403.50
8"	MC3138	735.25
10"	MC31310¹	1335.00
12"	MC31312¹	1646.20



¹ 10" and 12" supplied with ACB304 lever assist bar on page E-66

• For flange dimensions, diagrams and additional information please reference dixonvalve.com.



Type B Male Weld-On

Size	Unplated Steel	
	Part #	Price/E
2"	3032	\$4.35
3"	3033	4.90
4"	3034	13.50
6"	3036	20.50
8"	3038	42.00
10"	30310	93.70
12"	30312	134.00



- female and male fittings are commonly used for butt-welding to pipe

Type B Heavy Duty Female x Dixon® Combination Nipple Hose Shank

Size	Galvanized Steel	
	Part #	Price/E
2"	FC3102ST25	\$82.10
3"	FC3103ST35	132.10
4"	FC3104ST40	153.00
6"	FC3106ST60	303.65
8"	FC3108ST80	428.00

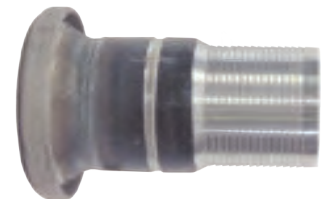



Type B Female x 150# ASA Flange

Feature:

- supplied with gasket

Size	Galvanized Steel	
	Part #	Price/E
4"	FC3144	\$152.00
6"	FC3146	262.50
8"	FC3148	453.60
10"	FC31410	804.70
12"	FC31412	1040.25

- For flange dimensions, diagrams and additional information please reference dixonvalve.com.

Type B Female Weld-On with Gasket

Feature:

- supplied with gasket



Size	Unplated Steel	
	Part #	Price/E
2"	3022	\$5.90
3"	3023	6.85
4"	3024	17.10
6"	3026	36.10
8"	3028	69.25
10"	30210	163.75
12"	30212	230.70

Type B Male x Female 90° Elbow

Feature:

- supplied with gasket



Size	Galvanized Steel	
	Part #	Price/E
4"	EL3154-90	\$211.00
6"	EL3156-90	399.60
8"	EL3158-90	691.00
10"	EL31510-90¹	1340.25
12"	EL31512-90¹	1687.00

- ¹ 10" and 12" supplied with ACB304 lever assist bar on page E-66

Type B Male x Female 45° Elbow

Feature:

- supplied with gasket



Size	Galvanized Steel	
	Part #	Price/E
4"	EL3154-45	\$211.00
6"	EL3156-45	399.60
8"	EL3158-45	584.50
10"	EL31510-45¹	1160.80
12"	EL31512-45¹	1472.70

- ¹ 10" and 12" supplied with ACB304 lever assist bar

Type B Female x Male Reducer

Feature:

- supplied with gasket

Female Size	Male Size	Galvanized Steel	
		Part #	Price/E
6"	4"	FMR31864	\$182.40
8"	6"	FMR31886	353.50
10"	8"	FMR318108¹	686.30
12"	10"	FMR3181210¹	1217.90



Industrial Hose Fittings

¹ 10" and 12" supplied with ACB304 lever assist bar on page E-66

Type B Female x Male Increaser

Feature:

- supplied with gasket

Female Size	Male Size	Galvanized Steel	
		Part #	Price/E
4"	6"	FMI31946	\$232.70
6"	8"	FMI31968	470.00
8"	10"	FMI319810	948.00
10"	12"	FMI3191012¹	1280.00



¹ 10" and 12" supplied with ACB304 lever assist bar on page E-66

Type B Male with Male NPT- extra long

Size	Galvanized Steel	
	Part #	Price/E
2"	MCM3112XL	\$66.75
3"	MCM3113XL	102.60
4"	MCM3114XL	171.60
6"	MCM3116XL	326.50
8"	MCM3118XL	614.60

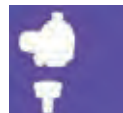

Type B Male Plugs

Size	Galvanized Steel	
	Part #	Price/E
2"	MP3232	\$39.00
3"	MP3233	60.75
4"	MP3234	105.50
6"	MP3236	190.10
8"	MP3238	350.75
10"	MP32310¹	761.60
12"	MP32312¹	944.80



¹ 10" and 12" supplied with ACB304 lever assist bar on page E-66

Type B Female Plugs

Feature:

- supplied with gasket



Size	Galvanized Steel	
	Part #	Price/E
2"	FP3082	\$16.70
3"	FP3083	18.90
4"	FP3084	35.50
6"	FP3086	81.25
8"	FP3088	129.25
10"	FP30810	326.25
12"	FP30812	450.75

Type B Lever Rings



Size	Galvanized Steel	
	Part #	Price/E
2"	LR3042	\$22.50
3"	LR3043	40.90
4"	LR3044	73.10
6"	LR3046	140.00
8"	LR3048	268.25
10"	LR30410	569.00
12"	LR30412	685.00

Type B Lever Assist Bar



Size	Description	Galvanized Steel	
		Part #	Price/E
10" & 12"	lever assist bar for 10" and 12" Type B fittings	ACB304	\$41.75

Type B Gaskets



Size	Rubber		EPDM	
	Part #	Price/E	Part #	Price/E
2"	RG3052	\$1.15	RG3062	\$4.55
3"	RG3053	2.05	RG3063	6.35
4"	RG3054	5.20	RG3064	9.85
6"	RG3056	10.10	RG3066	20.75
8"	RG3058	23.00	RG3068	38.00
10"	RG30510	33.75	RG30610	47.50
12"	RG30512	51.25	RG30612	60.50

Type B Quick Connect Safety Clips

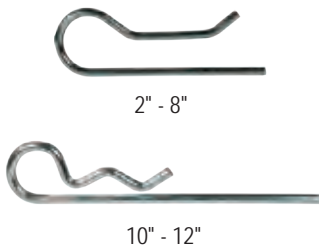

Size	Galvanized Steel	
	Part #	Price/E
2"	SP59	\$8.55
3"	SP76	8.95
4"	SP89	9.70
6"	SP159	10.00
8"	SP159	10.00
10"	SP390	13.10
12"	SP390	13.10

Expansion Ring Couplings for Single Jacket Hose - Aluminum

Industrial Hose
Fittings

Size	Thread	Bowl	Aluminum	
			Part #	Price/E
1"	NPSH	1¼"	S10125	\$51.55
1½"	NPSH	1¾"	S16175	55.00
1½"	NPSH	1-11/16"	S16168	54.90
1½"	NPSH	1-13/16"	S16181	55.00
2"	NPSH	2¼"	S20225	96.80
2½"	NPSH	2-13/16"	S26281	102.50
1½"	NST (NH)	1-11/16"	S16168F	54.90
1½"	NST (NH)	1¾"	S16175F	55.00
1½"	NST (NH)	1-13/16"	S16181F	54.90
2½"	NST (NH)	2-11/16"	S26268F	107.40
2½"	NST (NH)	2-13/16"	S26281F	102.50
1½"	MNPT	1-11/16"	MS16168T ¹	47.55
1½"	MNPT	1¾"	MS16175T ¹	41.50
2"	MNPT	2-1/4"	MS20225T ¹	60.20
2½"	MNPT	2-11/16"	MS26268T ¹	75.65



¹ male fitting only

Expansion Ring Coupling for Single Jacket Hose - Brass

Features:

- all couplings come complete with expansion rings, swivel and tail washers
- for females only, use 2/3 set price, for males only, use 1/2 set price, both shipped from the factory only
- aluminum expansion ring couplings have 3 rocker lugs on the male and female
- now stocking popular sizes in male and female only

Size	Thread	Bowl	Brass	
			Part #	Price/E
1½"	NPSH	1-3/4"	RS15175	\$135.20
1½"	NPSH	1-13/16"	RS15181	135.20
2½"	NPSH	2-13/16"	RS25281	263.50
1½"	NST (NH)	1-3/4"	RS15175F	135.20
1½"	NST (NH)	1-13/16"	RS15181F	135.20
2½"	NST (NH)	2-13/16"	RS25281F	263.50



Expansion Ring Couplings for Double Jacket Hose - Aluminum

Industrial Hose Fittings



Aluminum

Size	Thread	Bowl	Aluminum	
			Part #	Price/E
1½"	NPSH	1-13/16"	D16181	\$55.00
1½"	NPSH	1-15/16"	D16193	59.85
1½"	NPSH	2-1/16"	D16206	62.35
2"	NPSH	2-5/16"	D20231	96.95
2½"	NPSH	3"	D263	107.60
1½"	NST (NH)	1-13/16"	D16181F	55.00
1½"	NST (NH)	1-15/16"	D16193F	59.85
1½"	NST (NH)	2-1/16"	D16206F	62.35
2½"	NST (NH)	2-7/8"	D26287F	111.15
2½"	NST (NH)	3"	D263F	107.60
1½"	MNPT	1-13/16"	MD16181T¹	47.55
2"	MNPT	2-5/16"	MD20231T¹	61.60
2½"	MNPT	2-7/8"	MD26287T¹	75.65

¹ male fitting only

Brass



Size	Thread	Bowl	Brass	
			Part #	Price/E
1½"	NPSH	1-15/16"	RD15193	\$127.35
1½"	NST (NH)	1-15/16"	RD15193F	127.35

Hose Type Booster Hose Couplings



Features:

- special tooling is required to attach these couplings to hose
- hardcoat finish
- complete set
- working pressure: **800 PSI** at ambient temperature **70°F (21°C)**
- ¾" and 1" NST threads are the same size; also known as **Chemical Hose Thread (CHT)** or **Booster Hose Thread**

Hose Size	Thread Type	Bowl Size	Aluminum Hardcoat	
			Part #	Price/E
¾"	1" NPSH	1-1/4"	ABH08125	\$226.25
1"	1" NST (NH)	1-7/16"	ABH10143F	226.25
1"	1" NST (NH)	1-1/2"	ABH10150F	226.25

Forestry Coupling Gasket



Part #	Price/E
QTG-F	\$7.00

Forged Forestry Couplings

Features:

- maximum operating pressure: **300 PSI** at ambient temperature **70°F (21°C)**
- adapters have a common quarter turn sexless head (a 1½" QT fitting will mate with a ¾" QT or 1" QT)

¼ Turn Male

Thread	Forged Aluminum	
	Part #	Price/E
¾" GHT	QTM75GHT-F	\$74.25
1" NPSH	QTM100S-F	71.05
1" NPT	QTM100T-F	71.05
1½" NST (NH)	QTM150F-F	42.45
1½" NPT	QTM150T-F	68.40



¼ Turn Female

Thread	Forged Aluminum	
	Part #	Price/E
¾" GHT	QTF75GHT-F	\$79.80
1" NPSH	QTF100S-F	89.10
1" NPT	QTF100T-F	89.10
1½" NST (NH)	QTF150F-F	57.60
1½" NPT	QTF150T-F	81.90



Quick Connect Forestry Expansion Ring Couplings

**Feature:**

- sold in sets of (2) with expansion ring

Hose Size	Bowl Size	Forged Aluminum	
		Part #	Price/E
1½"	1-11/16"	QTX150-F	\$95.30

Expansion Rings

Feature:

- used with the fire hose couplings listed on page E-67



OD	Length	Wall Thickness	85/15 red brass	
			Part #	Price/E
1"	1¼"	.05	ER10125	\$8.50
1½"	¾"	.05	ER1575	8.40
1½"	7/8"	.05	ER1587	9.55
1½"	1"	.05	ER1510	9.85
1½"	1¼"	.05	ER15125	9.85
1¾"	1¼"	.05	ER17125	13.45
2½"	1¼"	.062	ER27125	17.80
2½"	1½"	.062	ER27150	17.80
3"	2"	.07	ER3020	29.90



Swivel Washers

Feature:

- used on the swivel end of the fire hose couplings listed on page E-67

ID	OD	Thickness	Buna-N	
			Part #	Price/E
1-1/16"	1-7/16"	1/8"	SW100F	\$2.00
1-9/16"	2-1/16"	1/8"	SW150	2.00
2-1/16"	2 1/2"	1/8"	SW200	8.65
2-9/16"	3-3/16"	3/16"	SW250	3.25
3-1/16"	3-3/4"	1/4"	SW300F	6.85
4-1/16"	5-1/8"	1/4"	SW400F	9.20
4-9/16"	5-7/8"	1/4"	SW450F	10.25
5-1/16"	6-3/8"	1/4"	SW500F	15.20
6-1/16"	7-1/8"	1/4"	SW600F	19.75



Industrial Hose
Fittings

Tail Washers

Feature:

- used on the tail end of the fire hose couplings listed on page E-67

ID	OD	Thickness	Buna-N	
			Part #	Price/E
1-1/32"	1-5/16"	3/16"	STW100	\$2.90
1-9/16"	1 3/4"	3/16"	RTW150	1.95
1-9/16"	1-15/16"	3/16"	STW150	1.85
1-5/8"	2 1/8"	3/16"	DTW150	1.95
2-9/16"	3"	1/4"	STW250	4.00
2-5/8"	3 1/4"	1/4"	DTW250	3.25
3 1/8"	3-25/32"	1/4"	DTW300	6.80



Expansion Ring and Gasket Guide

Industrial Hose
Fittings

Coupling Part #	Swivel Washer Part #	Tail Washer Part #	Expansion Ring Part #
<i>D15193 & D15193F</i>	<i>SW150</i>	<i>DTW150</i>	<i>ER15125</i>
<i>D15206F</i>	<i>SW150</i>	<i>G12014</i>	<i>ER15125</i>
<i>D16187 & D16187F</i>	<i>SW150</i>	<i>DTW150</i>	<i>ER15125</i>
<i>D16193 & D16193F</i>	<i>SW150</i>	<i>DTW150</i>	<i>ER15125</i>
<i>D16206 & D16206F</i>	<i>SW150</i>	<i>G12014</i>	<i>ER15125</i>
<i>D253 & D253F</i>	<i>SW250</i>	<i>DTW250</i>	<i>ER27150</i>
<i>D26287F</i>	<i>SW250</i>	<i>DTW250</i>	<i>ER27150</i>
<i>D263 & D263F</i>	<i>SW250</i>	<i>DTW250</i>	<i>ER27150</i>
<i>MD16181T</i>	n/a	<i>STW150</i>	<i>ER15125</i>
<i>MD20231T</i>	n/a	special	special
<i>MD26287T</i>	n/a	<i>DTW250</i>	<i>ER27150</i>
<i>MS16168T</i>	n/a	<i>STW150</i>	<i>ER15125</i>
<i>MS16175T</i>	n/a	<i>STW150</i>	<i>ER15125</i>
<i>MS20225T</i>	n/a	special	special
<i>MS26268T</i>	n/a	<i>STW250</i>	<i>ER27150</i>
<i>RD15193 & RD15193F</i>	<i>SW150</i>	<i>DTW150</i>	<i>ER15125</i>
<i>RD15206 & RD15206F</i>	<i>SW150</i>	<i>G12014</i>	<i>ER15125</i>
<i>RD253 & RD253F</i>	<i>SW250</i>	<i>DTW250</i>	<i>ER27150</i>
<i>RH15168 & RH15168F</i>	<i>SW150</i>	<i>RTW150</i>	<i>ER1575</i>
<i>RH16168F & RH16168F</i>	<i>SW150</i>	<i>RTW150</i>	<i>ER1575</i>
<i>RS15175 & RS15175F</i>	<i>SW150</i>	<i>STW150</i>	<i>ER15125</i>
<i>RS15181 & RS15181F</i>	<i>SW150</i>	<i>STW150</i>	<i>ER1510</i>
<i>RS25281 & RS25281F</i>	<i>SW250</i>	<i>STW250</i>	<i>ER27125</i>
<i>RS25287</i>	<i>SW250</i>	<i>STW250</i>	<i>ER27150</i>
<i>S15175 & S15175F</i>	<i>SW150</i>	<i>RTW150</i>	<i>ER15125</i>
<i>S15181 & S15181F</i>	<i>SW150</i>	<i>RTW150</i>	<i>ER1510</i>
<i>S16168 & S16168F</i>	<i>SW150</i>	<i>STW150</i>	<i>ER15125</i>
<i>S16175 & S16175F</i>	<i>SW150</i>	<i>STW150</i>	<i>ER15125</i>
<i>S16181 & S16181F</i>	<i>SW150</i>	<i>STW150</i>	<i>ER15125</i>
<i>S25281 & S25281F</i>	<i>SW250</i>	<i>STW250</i>	<i>ER27125</i>
<i>S25287 & S25287F</i>	<i>SW250</i>	<i>STW250</i>	<i>ER27150</i>
<i>S26268 & S26268F</i>	<i>SW250</i>	<i>STW250</i>	<i>ER27150</i>
<i>S26275 & S26275F</i>	<i>SW250</i>	<i>STW250</i>	<i>ER27150</i>
<i>S26281 & S26281F</i>	<i>SW250</i>	<i>STW250</i>	<i>ER27150</i>

Band & Worm Gear Clamps ... F-2 to F-14

Dixon® HS and HSS styles	F-2
Miniature MH and MAH styles	F-2
Aero-Seal® style.....	F-3
Marine grade	F-3
Aero-Seal® style line	F-4
Wave Seal	F-4
Constant torque	F-5
HTM hi torque.....	F-5
Center punch.....	F-6
Pre-formed F series	F-6
Open end FO series.....	F-6
Universal pre-formed, K series	F-7
Dixon® smooth ID	F-8
Roll-over type.....	F-8
Center punch	F-8
Band and buckle.....	F-9
Clamp buckles	F-9
Strapping.....	F-9
Set screw buckles	F-9
Banding.....	F-9
Band clamp tools.....	F-10 to F-11
Portable locking hand tool.....	F-10
Intermediate hand tool	F-10
Hand tool for 5/8" clamps.....	F-10
Hand tool for 3/8" and 1/2" clamps	F-10
Adapter for F100 tool.....	F-10
Hand tool for K clamps.....	F-10
Punching mallet	F-11
Clamp cutter.....	F-11
Clamping tool for band and buckles	F-11
Band and buckle clamping tool.....	F-11
Clamping tool adapter for 51960 tool.....	F-11
Single ear	F-12
Double ear	F-12
Stepless® ear	F-13
Service kit.....	F-13
Standard jaw clamp tool	F-13
Side jaw clamp tool.....	F-13
Dixon® clamp racks	F-14
Quick release.....	F-14
Make-A-Clamp kits	F-14

Bolted Clamps..... F-15 to F-20

T-bolt TBC and STBC styles.....	F-15
Heavy duty T-bolt.....	F-16
Long T-bolt.....	F-17
Double bolt	F-18
With saddles	F-18
Single bolt.....	F-19

Bolted Clamps (cont.) F-15 to F-20

Hydraulic hose clamps	F-19
For 1 wire hose	F-19
For 1 or 2 wire hose	F-19
Spiral clamps.....	F-20
Clockwise.....	F-20
Counterclockwise	F-20
Air King™	F-20

Crimp Ferrules & Sleeves... F-21 to F-23

Short crimp sleeves.....	F-21
Notched ferrules	F-22
Global Air King™ ferrules	F-22
Brass ferrules for air and fluid.....	F-23
Brass ferrules for fluid.....	F-23

Coupling Tools, Machines, Acc .. F-24 to F-27

Ribbed and plain dies	F-24
Manually operated brass ferrule crimper	F-25
Air operated brass ferrule crimper	F-25
Small hose crimper.....	F-26
Crimper dies.....	F-26
Large hose crimper.....	F-27
Crimper dies.....	F-27



Dixon® Worm Gear Clamps

Features:

- clamp meets SAEJ1508 which supercedes Mil Spec WW-C-440B
- four-piece construction
- screw design: 5/16" slotted hex head
- maximum recommended torque 50 in. lbs.
- **all clamps sold 10 per box**

Style HS material:

- band and housing: SAE 201/301 series stainless
- screw: SAE 1018 case-hardened, hex-free chrome zinc-plated steel

Style HSS material:

- band and housing: SAE 300 series stainless
- screw: SAE 300 series stainless



style HSS

Band Width	Hose OD		style HS		Master Case Qty	style HSS		Master Case Qty
	from	to	Part #	Price/Each		Part #	Price/Each	
1/2"	7/16"	25/32"	HS6	\$1.50	200	HSS6	\$2.00	200
	1/2"	29/32"	HS8	1.50	200	HSS8	2.00	200
	9/16"	1-1/16"	HS10	1.50	500	HSS10	2.00	500
	11/16"	1-1/14"	HS12	1.55	500	HSS12	2.00	500
	13/16"	1-1/2"	HS16	1.55	500	HSS16	2.00	500
	13/16"	1-3/4"	HS20	1.55	500	HSS20	2.05	500
	1-1/16"	2"	HS24	1.55	500	HSS24	2.05	500
	1-5/16"	2-1/4"	HS28	1.60	500	HSS28	2.05	500
	1-9/16"	2-1/2"	HS32	1.60	500	HSS32	2.05	500
	1-13/16"	2-3/4"	HS36	1.65	500	HSS36	2.15	500
	2-1/16"	3"	HS40	2.00	200	HSS40	2.45	200
	2-5/16"	3-1/4"	HS44	2.20	200	HSS44	2.80	200
	2-9/16"	3-1/2"	HS48	2.20	200	HSS48	2.80	200
	2-13/16"	3-3/4"	HS52	2.40	200	HSS52	2.95	200
	3-1/16"	4"	HS56	2.40	200	HSS56	2.95	200
	3-5/16"	4-1/4"	HS60	2.50	200	HSS60	3.00	200
9/16"	3-9/16"	4-1/2"	HS64	2.50	200	HSS64	3.00	200
	1-7/8"	5"	HS72	2.70	100	HSS72	3.30	100
	2-1/2"	5-1/2"	HS80	3.10	100	HSS80	3.40	100
	3-1/8"	6"	HS88	3.20	100	HSS88	3.75	100
	3-5/8"	6-1/2"	HS96	3.25	100	HSS96	3.85	100
	4-1/8"	7"	HS104	3.30	100	HSS104	3.35	100
	5-5/8"	8-1/2"	HS128	4.90	100	HSS128	5.25	100
	7-1/8"	10"	HS152	5.25	100	HSS152	5.80	100
	9-3/8"	12-1/4"	HS188	5.75	100	HSS188	6.35	100
	10-1/8"	13"	HS200	5.80	100	HSS200	6.80	100
	10-7/8"	13-3/4"	HS212	5.90	100	HSS212	7.15	100
	11-5/8"	14-1/2"	HS224	6.55	100	HSS224	7.60	100
	12-3/8"	15-1/4"	HS236	7.10	100	HSS236	8.40	100
	13-1/8"	16"	HS248	7.45	100	HSS248	9.40	100
17-1/8"	20"	HS312	9.10	100	HSS312	10.75	100	

Miniature Worm Gear Clamps

Features:

- meets SAE J1508
- screw design: 1/4" slotted hex head
- maximum recommended torque 15 in. lbs.
- **all clamps sold 10 per box**

Style MH material:

- band and housing: SAE 201/301 series stainless
- screw: SAE 1018 case-hardened, hex-free chrome zinc-plated steel

Style MAH material:

- band and housing: SAE 300 series stainless
- screw: SAE 300 series stainless



style MH

Band Width	Hose OD		style MH		Master Case Qty	style MAH		Master Case Qty
	from	to	Part #	Price/Each		Part #	Price/Each	
5/16"	7/32"	5/8"	MH4	\$1.15	500	MAH4	\$1.45	500
	7/16"	25/32"	MH6	1.15	500	MAH6	1.45	500
	1/2"	29/32"	MH8	1.35	200	MAH8	1.65	200
	9/16"	1-1/16"	MH10	1.35	200	MAH10	1.65	200
	11/16"	1-1/4"	MH12	1.40	200	MAH12	1.75	200
	15/16"	1-1/2"	MH16	1.40	200	MAH16	1.75	200
	1-3/16"	1-3/4"	MH20	1.45	200	MAH20	1.75	200

Torque ratings correspond to the torque rating of the screw of the clamp and are not an indication of the working pressure of any hose assembly installed with this clamp.

Aero-Seal® Worm Gear Clamps

Features:

- four-piece construction
- band slots designed for strength and smooth action
- saddle interlocks into embossed band to form a true concentric circle
- slotted hex head screw design
- heat treated screws have buttress thread type
- safety collar or thumb screw available on the style 200 series only
- suggested installation torque 30-42 inch pounds, maximum recommended torque 60 in. lbs.
- **all clamps sold 10 per box**
- Torque ratings correspond to the torque rating of the screw of the clamp and *are not an indication of the working pressure of any hose assembly installed with this clamp.* 

Style 100:

- band and housing: 300 SS
- screw: plated carbon steel

Style 200:

- band and housing: 300 SS
- screw: 410 stainless steel

Style 300:

- band and housing: 302 SS
- screw: 305 stainless steel

Band Width	Hose OD		Style 100		Style 200		Style 300		Pkg Qty
	from	to	Part #	Price/E	Part #	Price/E	Part #	Price/E	
9/16"	7/16"	25/32"	10006	\$1.95	20006	\$2.40	30006	\$2.75	10
	1/2"	29/32"	10008	1.95	20008	2.40	30008	2.75	10
	9/16"	1-1/16"	10010	1.95	20010	2.40	30010	2.75	10
	11/16"	1-1/4"	10012	2.05	20012	2.50	30012	2.85	10
	13/16"	1-1/2"	10016	2.05	20016	2.50	30016	2.85	10
	13/16"	1-3/4"	10020	2.05	20020	2.50	30020	2.90	10
	1-1/16"	2"	10024	2.05	20024	2.50	30024	2.90	10
	1-5/16"	2-1/4"	10028	2.10	20028	2.60	30028	2.95	10
	1-9/16"	2-1/2"	10032	2.10	20032	2.60	30032	2.95	10
	1-13/16"	2-3/4"	10036	2.15	20036	2.65	30036	3.00	10
	1-1/16"	3"	10040	2.65	20040	3.25	30040	3.70	10
	2-5/16"	3-1/4"	10044	2.85	20044	3.55	30044	4.00	10
	2-9/16"	3-1/2"	10048	2.85	20048	3.55	30048	4.00	10
	2-13/16"	3-3/4"	10052	3.05	20052	3.80	30052	4.25	10
	3-1/16"	4"	10056	3.05	20056	3.80	30056	4.25	10
	3-5/16"	4-1/4"	10060	3.30	20060	4.10	30060	4.60	10



style 300

Marine Grade Worm Gear Clamps

Features:

- three-piece construction
- clamp meets SAEJ1508 which supercedes Mil Spec WW-C-440B
- 316 stainless steel marine grade: band, screw, housing
- screw design: 5/16" slotted hex head
- suggested installation torque 30-42 inch pounds, maximum recommended torque 60 in. lbs.
- **all clamps sold 10 per box**
- Torque ratings correspond to the torque rating of the screw of the clamp and *are not an indication of the working pressure of any hose assembly installed with this clamp.* 

Band Width	Hose OD		316 Stainless Steel	
	from	to	Part #	Price/E
1/2"	3/8"	7/8"	MGC6	\$2.95
	7/16"	1"	MGC8	2.95
	9/16"	1-1/16"	MGC10	2.95
	9/16"	1-5/16"	MGC12	3.05
	11/16"	1-1/2"	MGC16	3.05
	3/4"	1-3/4"	MGC20	3.05
	1-1/16"	2"	MGC24	3.05
	1-5/16"	2-1/4"	MGC28	3.10
	1-9/16"	2-1/2"	MGC32	3.10
	1-13/16"	2-3/4"	MGC36	3.20
	2-11/16"	3"	MGC40	3.40
	2-5/16"	3-1/4"	MGC44	3.95
	2-9/16"	3-1/2"	MGC48	3.95
	2-13/16"	3-3/4"	MGC52	4.20
	3-1/16"	4"	MGC56	4.20
	2-1/2"	4-1/2"	MGC64	4.65
	3-1/16"	5"	MGC72	4.80
	3-1/2"	5-1/2"	MGC80	5.30
	4-3/32"	6"	MGC88	5.45
	4-1/2"	6-1/2"	MGC96	5.65
5"	7"	MGC104	5.70	



Aero-Seal® Liner Worm Gear Clamps

Features:

- The integral extension of the band as a liner (no rivets or welds) protects soft surface hose (silicone and others) from damage caused by extrusion or shearing through the band slots.
- screw design: 5/16 hex slotted hex head
- **all clamps sold 10 per box**
- band, saddle, housing: stainless steel

Style DL:

- screw: plated carbon steel

Style DLS:

- screw: 410 stainless steel



style DLS

Band Width	Hose OD		style DL		Pkg Qty	style DLS		Pkg Qty
	from	to	Part #	Price/E		Part #	Price/E	
1/2"	7/16"	25/32"	DL9206	\$3.15	10	DLS9406	\$3.80	10
	1/2"	29/32"	DL9208	3.15	10	DLS9408	3.80	10
	9/16"	1-1/16"	DL9210	3.15	10	DLS9410	3.80	10
	11/16"	1-1/4"	DL9212	3.20	10	DLS9412	3.90	10
	13/16"	1-1/2"	DL9216	3.20	10	DLS9416	3.90	10
	13/16"	1-3/4"	DL9220	3.25	10	DLS9420	3.95	10
	1-1/16"	2"	DL9224	3.25	10	DLS9424	3.95	10
	1-5/16"	2-1/4"	DL9228	3.35	10	DLS9428	4.00	10
	1-9/16"	2-1/2"	DL9232	3.35	10	DLS9432	4.00	10
	1-13/16"	2-3/4"	DL9236	3.40	10	DLS9436	4.10	10
	2-1/16"	3"	DL9240	4.20	10	DLS9440	5.00	10
	2-5/16"	3-1/4"	DL9244	4.50	10	DLS9444	5.05	10
	2-9/16"	3-1/2"	DL9248	4.50	10	DLS9448	5.20	10

WaveSeal Clamps

Application:

- provides optimal retention in applications involving thermal cycling and / or high vibration

Features:

- produces a sealing O-ring effect that prevents leakage
- 5/16" head screw
- suggested installation torque 50-70 inch pounds, maximum recommended torque 100 in. lbs.
- **all clamps sold 10 per box**
- construction:
 - band: 201/301 stainless steel
 - liner and housing: 304 stainless steel
 - screw: 410 stainless steel
- Torque ratings correspond to the torque rating of the screw of the clamp and *are not an indication of the working pressure of any hose assembly installed with this clamp.* 



Band Width	Hose OD		316 Stainless Steel		Pkg Qty
	from	to	Part #	Price/E	
9/16"	1-3/32"	1-5/16"	WSS16	\$6.00	10
	1-1/8"	1-1/2"	WSS19	6.05	10
	1-1/8"	1-9/16"	WSS20	6.05	10
	1-7/16"	1-11/16"	WSS22	6.40	10
	1-1/2"	1-13/16"	WSS24	6.50	10
	1-3/4"	2-1/16"	WSS28	6.80	10
	1-15/16"	2-5/16"	WSS32	6.80	10
	2"	2-7/16"	WSS34	7.45	10
	2-1/8"	2-9/16"	WSS36	7.60	10
	2-5/16"	2-13/16"	WSS40	7.95	10
	2-1/2"	3-1/16"	WSS44	7.95	10
	2-11/16"	3-5/16"	WSS48	8.25	10
	2-7/8"	3-9/16"	WSS52	8.65	10
	3-1/16"	3-13/16"	WSS56	9.10	10
	3-1/4"	4-1/16"	WSS60	9.50	10
	3-7/16"	4-5/16"	WSS64	9.85	10
	3-3/4"	4-13/16"	WSS72	10.60	10
	4-3/16"	5-5/16"	WSS80	12.00	10
	4-1/2"	5-13/16"	WSS88	12.80	10

Constant Torque Worm Gear Clamps

Features:

- A patented Belleville spring mechanism permits the clamp to automatically increase or decrease its own diameter due to changes in operational or environmental temperatures.
- 3/8" hex, carbon steel screw
- 5/8" wide 304 stainless steel band

Band Width	Hose OD		Part #	Price/E	Pkg Qty
	from	to			
5/8"	1"	1 3/4"	CT175L	\$19.30	10
	1 1/4"	2 1/8"	CT200L	19.30	10
	1 3/4"	2 5/8"	CT250L	19.50	10
	2 1/4"	3 1/8"	CT300L	19.80	10
	2 3/4"	3 5/8"	CT350L	20.00	10
	3 1/4"	4 1/8"	CT400L	20.25	10
	3 3/4"	4 5/8"	CT450L	20.50	10
	4 1/4"	5 1/8"	CT500L	20.75	10
	4 3/4"	5 5/8"	CT550L	21.50	10
	5 1/4"	6 1/8"	CT600L	21.75	10
	5 3/4"	6 5/8"	CT650L	21.75	10
	6 1/4"	7 1/8"	CT700L	22.25	10
	6 3/4"	7 5/8"	CT750L	23.25	10
	7 1/4"	8 1/8"	CT800L	23.50	---
	7 3/4"	8 5/8"	CT850L	23.75	---
	8 1/4"	9 1/8"	CT900L	24.00	---
	8 3/4"	9 5/8"	CT950L	24.50	---



HTM Hi Torque Worm Gear Clamps

Features:

- withstands more than three times the SAE torque requirements for worm-driven clamps
- eight screw threads are engaged in the band simultaneously for incredible torquing drive (over 90 in. lbs.), sealing pressure and vibration resistance
- slotted hex head screw design
- Torque ratings correspond to the torque rating of the screw of the clamp and *are not an indication of the working pressure of any hose assembly installed with this clamp.* 

Materials:

- band and housing: 300 series half hard stainless ¹
- screw: 410 stainless steel screw

Band Width	Hose OD		Stainless Steel	
	from	to	Part #	Price/E
5/8"	1 1/4"	2 1/8"	HTM200	\$5.05
	1 1/4"	2 5/8"	HP2 ¹	5.10
	1 3/4"	2 5/8"	HTM250	5.10
	2 1/8"	4 1/8"	HP3 ¹	5.55
	2 1/4"	3 1/8"	HTM300	5.30
	2 3/4"	3 5/8"	HTM350	5.40
	3 1/2"	4 1/8"	HTM400	5.55
	3 3/4"	4 5/8"	HTM450	5.70
	4"	6 1/8"	HP4 ¹	6.45
	4 1/4"	5 1/8"	HTM500	5.90
	4 3/4"	5 5/8"	HTM550	6.30
	5 1/4"	6 1/8"	HTM600	6.45
	5 3/4"	6 5/8"	HTM650	6.55
	6 1/8"	9 1/8"	HP5 ¹	7.80
	6 1/4"	7 1/8"	HTM700	6.75
	6 3/4"	7 5/8"	HTM750	7.30
	7 1/4"	8 1/8"	HTM800	7.45
	7 3/4"	8 5/8"	HTM850	7.60
	8 1/4"	9 1/8"	HTM900	7.80

¹ extended hose OD range



style HTM



style HP

Center Punch Band Clamps

Features:

- install with center punch tools F1, F38, F40 and F100 located on page F-10 other manufacturer's punch style tools may also be used
- on stainless clamps, bands are 300 series stainless steel, buckles are 302 series stainless steel
- **sold in package quantities only**

Center Punch Pre-formed F Series

Band Width	Clamp ID	Band THK	Stainless Steel		Pkg Qty	Band THK	Galvanized Steel		Pkg Qty
			Part #	Price/E			Part #	Price/E	
3/8"	13/16"	.020"	FS3	\$1.65	100	.025"	F3	\$1.00	100
	1-3/8"	.020"	FS311	1.85	100	.025"	F311	1.10	100
5/8"	1"	.022"	FS4	2.15	100	.025"	F4	1.15	100
	1-1/4"	.022"	FS5	2.25	100	.025"	F5	1.15	100
	1-1/2"	.022"	FS6	2.45	100	.031"	F6	1.30	100
	1-3/4"	.022"	FS7	2.60	100	.031"	F7	1.35	100
	2"	.022"	FS8	2.85	100	.031"	F8	1.40	100
	2-1/4"	.022"	FS9	2.95	100	.031"	F9	1.45	100
	2-1/2"	.022"	FS10	3.20	50	.031"	F10	1.70	50
	2-3/4"	.022"	FS11	3.30	50	.031"	F11	1.75	50
	3"	.022"	FS12	3.55	50	.031"	F12	1.85	50
	3-1/2"	.022"	FS14	3.90	50	.031"	F14	2.00	50
	4"	.022"	FS16	4.35	25	.031"	F16	2.30	25
	4-1/2"	.022"	FS18	4.70	25	.031"	F18	2.50	25
	5"	.022"	FS20	5.10	25	.031"	F20	2.55	25
	6"	.022"	FS24	5.85	25	.031"	F24	3.00	25
	7"	.022"	FS28	6.55	25	.031"	F28	3.50	25
	8"	.022"	FS32	7.25	25	.031"	F32	3.90	25



Center Punch Open End FO Series

Band Width	Clamp ID	Band THK	Stainless Steel		Pkg Qty	Band THK	Galvanized Steel		Pkg Qty
			Part #	Price/E			Part #	Price/E	
3/8"	13/16"	.020"	FOS3	\$4.00	100	.025"	FO3	\$3.40	100
	1-3/8"	.020"	FOS311	4.20	100	.025"	FO311	3.60	100
	2"	.020"	FOS316	4.35	100	.025"	FO316	3.60	100
	3-1/8"	.020"	FOS325	4.75	100	.025"	FO325	3.70	100
5/8"	2"	.022"	FOS8	4.00	100	.025"	FO8	2.30	100
	2-1/2"	.022"	FOS10	4.25	50	.025"	FO10	2.40	50
	3"	.022"	FOS12	4.65	50	.031"	FO12	2.50	50
	3-1/2"	.022"	FOS14	5.10	50	.031"	FO14	2.70	50
	4"	.022"	FOS16	5.40	50	.031"	FO16	2.80	50
	4-1/2"	.022"	FOS18	5.85	50	.031"	FO18	3.05	50
	5"	.022"	FOS20	6.35	25	.031"	FO20	3.25	25
	6"	.022"	FOS24	7.10	25	.031"	FO24	3.45	25
	7"	.022"	FOS28	8.20	25	.031"	FO28	3.60	25
	8"	.022"	FOS32	9.25	25	.031"	FO32	3.95	25
	9"	.022"	---	---	25	.031"	FO36	4.60	25
	10"	.022"	---	---	25	.031"	FO40	4.80	25
	12"	.022"	---	---	25	.031"	FO48	5.80	25
	14"	.022"	---	---	10	.031"	FO56	7.05	10



Universal Pre-formed K series

Features:

- on stainless clamps, bands are 300 series stainless steel, buckles are 302 series stainless steel
- can be center punched or rolled over, install with the center punch or roll over tools located on page F-10
- Fast-Lok™ tools: F1, F40, F100 page F-10
- Super Strap Tools: 51960 screw action with 51970 adapter page F-11
- Bandit®: S100 air tool with S180 Jr. head, C-001 hand tool with J001 Jr. adapter, S350 air tool with S260 Jr. head, T-240 for 3/8" only or T-250 for 3/8" and 5/8", S-38 for 3/8" and 5/8", J-102 Pok-It™ for 3/8" only.
- Punch-Lok® tools: P-1000 for 3/8" and 5/8", P-3000 for 3/8" only, P-38 for 3/8" and 5/8"
- **sold in package quantities only**

Band Width	Clamp ID	Band THK	Stainless Steel		Pkg Qty	Band THK	Galvanized Steel		Pkg Qty
			Part #	Price/E			Part #	Price/E	
3/8"	13/16"	.025"	KS3	\$1.70	100	.025"	K3	\$1.10	100
	1-3/8"	.025"	KS311	1.80	100	.025"	K311	1.15	100
5/8"	1"	.030"	KS4	2.65	100	.031"	K4	1.50	100
	1-1/4"	.030"	KS5	2.70	100	.031"	K5	1.55	100
	1-1/2"	.030"	KS6	2.90	100	.031"	K6	1.60	100
	1-3/4"	.030"	KS7	3.10	100	.031"	K7	1.65	100
	2"	.030"	KS8	3.30	100	.031"	K8	1.70	100
	2-1/4"	.030"	KS9	3.55	100	.031"	K9	1.75	100
	2-1/2"	.030"	KS10	3.80	50	.031"	K10	1.85	50
	2-3/4"	.030"	KS11	4.15	50	.031"	K11	2.00	50
	3"	.030"	KS12	4.35	50	.031"	K12	2.10	50
	3-1/2"	.030"	KS14	4.80	50	.031"	K14	2.25	50
	4"	.030"	KS16	5.35	25	.031"	K16	2.50	25
	4-1/2"	.030"	KS18	5.75	25	.031"	K18	2.60	25
	5"	.030"	KS20	6.20	25	.031"	K20	2.80	25
	6"	.030"	KS24	7.05	25	.031"	K24	3.20	25
	7"	.030"	KS28	8.05	25	.031"	K28	3.70	25
	8"	.030"	KS32	8.95	25	.031"	K32	3.95	25



Dixon® Smooth ID - Roll Over Type Clamps

Application:

- for use with industrial hose made of stiffer, thinner thermoplastics

Features:

- provide a uniform, gap-free inside diameter, and strong holding power
- Install with roll over type clamp tools and most common band clamp tools such as the 51960 and 51970 band tools on page F-11.
- **sold in package quantities only**



Band Width	Clamp ID	Band THK	201 Stainless Steel		Pkg Qty	Galvanized Steel		Pkg Qty
			Part #	Price/E		Part #	Price/E	
3/8"	13/16"	.025"	JS201	\$2.45	100	JS301	\$1.20	100
	1"	.025"	JS243	2.80	100	JS343	1.15	100
	1-3/8"	.025"	JS202	2.70	100	JS302	1.30	100
	2"	.025"	JS245	3.10	100	---	---	---
1/2"	1"	.030"	JS203	3.40	100	JS303	1.45	100
	1-1/4"	.030"	JS204	3.70	100	JS304	1.55	100
	2-3/4"	.030"	JS230	5.60	100	JS330 ¹	2.30	100
5/8"	1-1/2"	.030"	JS205	4.50	100	JS305	1.70	100
	1-3/4"	.030"	JS206	4.95	100	JS306	1.90	100
	2"	.030"	JS207	5.45	100	JS307	2.15	100
	2-1/4"	.030"	JS208	5.75	100	JS308	2.20	100
	2-1/2"	.030"	JS209	6.15	100	JS309	2.35	100
3/4"	2-3/4"	.030"	JS210	7.30	50	---	---	---
	3"	.030"	JS211	7.95	50	JS311	3.00	50
	3-1/2"	.030"	JS212	8.45	50	JS312	3.20	50
	4"	.030"	JS213	9.65	25	JS313	3.70	25
	4-1/2"	.030"	JS214	10.40	25	JS314	3.90	25
	5"	.030"	JS215	11.20	25	JS315	4.30	25
	6"	.030"	JS216	12.90	25	---	---	---
	7"	.030"	JS218	15.50	25	---	---	---

¹ stock quantities only

Dixon® Smooth ID Center Punch Clamps

Application:

- for use in applications where conditions are highly corrosive

Features:

- double wrapped and locked with the conical punch of the F100 tool page F-10
- unique dimple design offers excellent sealing strength while maintaining radial compression
- heavy buckle provides optimal holding power
- ideal for thin wall hose
- low profile
- **sold in package quantities only**



Band Width	Clamp ID	Band THK	201 Stainless Steel		Pkg Qty
			Part #	Price/E	
5/8"	1"	.025"	HBC4S	\$2.20	100
	1 1/4"	.025"	HBC5S	2.40	100
	1 1/2"	.025"	HBC6S	2.50	100
	1 3/4"	.025"	HBC7S	2.70	100
	2"	.025"	HBC8S	2.90	100
	2 1/4"	.025"	HBC9S	3.05	100
	2 1/2"	.025"	HBC10S	3.30	50
	2 3/4"	.025"	HBC11S	3.45	50
	3"	.025"	HBC12S	3.60	50
	3 1/2"	.025"	HBC14S	4.00	50
	4"	.025"	HBC16S	4.55	25
	4 1/2"	.025"	HBC18S	4.80	25
	5"	.025"	HBC20S	5.15	25
	6"	.025"	HBC24S	5.90	25
	7"	.025"	HBC28S	6.65	25
	8"	.025"	HBC32S	7.40	25

Band & Buckles System

Features:

- install with C2 or 51960 band clamp tools
- **sold in box quantities only**

Band Width	201 Stainless Steel		Pkg Qty	Galvanized Steel		Pkg Qty
	Part #	Price/E		Part #	Price/E	
3/8"	CS375	\$0.87	100	CG375	\$0.44	100
1/2"	CS500	0.94	100	CG500	0.50	100
5/8"	CS625	1.31	100	CG625	0.60	100
3/4"	CS750	1.69	100	CG750	0.81	50



Strapping

Feature:

- install with C2 or 51960 band clamp tools

Band Width	Band Thickness	Length	201 Stainless Steel		Galvanized Steel	
			Part #	Price/E	Part #	Price/E
3/8"	.025"	100'	SS375	\$112.80	SG375	\$57.00
1/2"	.031"	100'	SS500	138.00	SG500	67.15
5/8"	.031"	100'	SS625	199.50	SG625	82.10
3/4"	.031"	100'	SS750	240.00	SG750	97.45



Set Screw Buckles

Application:

- Used in applications when a temporary clamp is desired or space limitations do not allow for tool roll-over

Features:

- set screw locks band after tensioning
- **sold in box quantities only**

Band Width	201 Stainless Steel		Pkg Qty
	Part #	Price/E	
1/2"	SSB500	\$4.45	25
3/4"	SSB750 ¹	5.70	25



¹ 3/4" buckle may be used with 5/8" band

Stainless Steel Banding with Tote

Features:

- resistant to moisture
- built-in handle
- full view of available band
- easy to dispense and recoil

Band Width	Band Thickness	Length	Package Description	201 Stainless Steel	
				Part #	Price/E
1/2"	.030"	100'	plastic blue tote	ST204B	\$142.25
5/8"	.030"	100'	plastic green tote	ST205G	184.00
3/4"	.030"	100'	plastic red tote	ST206R	235.00



Band Clamp Portable Locking Hand Tool

Features:

- for application of punch type 3/8" and 5/8" band clamps
- for use with F series only



Part #	Price/E
F38	\$92.30

Band Clamp Intermediate Hand Tool

Feature:

- for application of 3/8" and 5/8" band clamps



Part #	Price/E
F40	\$160.70

Band Clamp Hand Tool for 5/8" Clamps

Features:

- for application of 5/8" band clamps
- imported



Part #	Price/E
F1	\$206.10

Band Clamp Hand Tool for 3/8" & 5/8" Clamps

Feature:

- for application of 3/8" and 5/8" band clamps



Part #	Price/E
F100	\$365.50

Band Clamp Adapter for F100 Tool

Feature:

- 3/8" clamp adapter for F100 tool only



Part #	Price/E
F229	\$21.95

Band Clamp Punching Mallet

Part #	Price/E
F225	\$101.90



Clamp Cutter

Part #	Price/E
F550	\$141.95



Band & Buckle Tools

Description	Part #	Price/E
Clamping tool for band and buckles	C2	\$473.00



Description	Part #	Price/E
Clamping tool for band and buckles	51960	\$161.50



Feature:

- for 51960 tool above

Description	Part #	Price/E
adapter for 51960 tool to install preformed clamps	51970	\$144.50



Pinch-On Single Ear Clamps

Features:

- band width: .275"
- band thickness: .030"
- sold in package quantities only



Nominal Size	Range		Zinc Plated Steel		304 Stainless Steel		Pkg Qty
	closed	open	Part #	Price/E	Part #	Price/E	
3/8"	.350"	.413"	105	\$0.50	105R	\$0.60	100
7/16"	.382"	.445"	113	0.55	113R	0.60	100
15/32"	.409"	.484"	123	0.55	123R	0.60	100
1/2"	.449"	.524"	133	0.55	133R	0.60	100
35/64"	.469"	.551"	140	0.55	140R	0.60	100
9/16"	.496"	.571"	145	0.55	145R	0.65	100
5/8"	.543"	.618"	157	0.55	157R	0.65	100
11/16"	.595"	.669"	170	0.55	170R	0.65	100
23/32"	.618"	.728"	185	0.55	185R	0.70	100
3/4"	.669"	.780"	198	0.55	198R	0.70	100
13/16"	.717"	.827"	210	0.55	210R	0.70	100
7/8"	.780"	.890"	226	0.55	226R	0.72	100
15/16"	.839"	.949"	241	0.60	241R	0.75	100
1"	.898"	1.008"	256	0.60	256R	0.75	100
1-1/16"	.945"	1.067"	271	0.60	271R	0.80	100
1-1/8"	1.004"	1.126"	286	0.60	286R	0.80	100
1-3/16"	1.063"	1.185"	301	0.60	301R	0.80	100
1-5/16"	1.181"	1.303"	331	0.65	331R	0.85	100
1-3/8"	1.240"	1.362"	346	0.70	346R	0.90	100
1-15/32"	1.358"	1.480"	376	0.70	376R	0.90	100
1-9/16"	1.437"	1.559"	396	0.75	396R	0.95	100
1-5/8"	1.492"	1.614"	410	0.75	410R	0.95	100
1-11/16"	1.551"	1.673"	425	0.75	425R	1.00	100
1-23/32"	1.610"	1.732"	440	0.80	440R	1.00	100
1-3/4"	1.669"	1.791"	455	0.80	455R	1.00	100
1-13/16"	1.728"	1.850"	470	0.85	470R	1.05	100
1-7/8"	1.787"	1.909"	485	0.85	485R	1.05	100
1-15/16"	1.847"	1.969"	500	0.85	500R	1.10	100
2"	1.906"	2.028"	515	0.90	515R	1.10	100

Pinch-On Double Ear Clamps

Features:

- When ordering double ear clamps, select nominal clamp size nearest to, but always larger than, the OD of material to be clamped after insert has been fitted.
- sold in package quantities only



Nominal Size	Range		Band Width	Zinc Plated Steel		304 Stainless Steel		Pkg Qty
	closed	open		Part #	Price/E	Part #	Price/E	
3/16"	.134"	.197"	.197"	0305	\$0.90	0305R	\$1.15	100
1/4"	.197"	.276"	.236"	0507	0.95	0507R	1.20	100
5/16"	.276"	.354"	.275"	0709	0.95	0709R	1.25	100
3/8"	.319"	.433"	.275"	0811	0.95	0811R	1.25	100
1/2"	.425"	.512"	.275"	1113	0.95	1113R	1.35	100
9/16"	.492"	.591"	.295"	1315	1.10	1315R	1.50	100
19/32"	.551"	.669"	.315"	1517	1.10	1517R	1.65	100
5/8"	.591"	.709"	.315"	1518	1.10	1518R	1.75	100
3/4"	.638"	.787"	.335"	1720	1.20	1720R	1.95	100
13/16"	.709"	.866"	.354"	1922	2.15	1922R	2.00	100
7/8"	.748"	.906"	.354"	2023	1.35	2023R	2.15	100
15/16"	.827"	.984"	.394"	2225	2.50	2225R	2.25	100
1"	.886"	1.063"	.394"	2327	1.60	2327R	2.40	100
1-1/8"	1.035"	1.221"	.394"	2731	1.75	2731R	2.70	100
1-7/16"	1.260"	1.457"	.394"	3437	1.95	3437R	3.15	100
1-1/2"	1.378"	1.575"	.394"	3740	3.40	3740R	3.30	100

Pinch-On Stepless® Ear Clamps

Features:

- once installed and clamped tampering is easily visible
- *Clamps are not reusable*; they should not be pried open, doing so renders the clamp nonfunctional. 
- ensured clamping seal
- for low durometer or thin-walled hose/tubing
- for silicon, vinyl, polyurethane or other high-tech materials
- smooth inner band prevents damage to the hose while the tongue-in-groove design provides a 360° seal
- no steps or gaps inside the clamp
- install clamps using 1098 or 1099 clamp tools below
- clamps hold against pressure, vibration and material shrinkage due to temperature changes or aging
- built-in spring action permits the clamp to breathe without loosening
- When ordering, select the nominal size nearest to, but always larger than, the outside diameter of the material to be clamped. The outside diameter should be determined with connection fully assembled.
- **sold in package quantities only**



Nominal Size	Range (inches)		304 Stainless Steel		Pky Qty
	closed	open	Part #	Price/E	
9/32"	.228"	.275"	0983	\$1.05	100
3/8"	.307"	.374"	0986	1.05	100
7/16"	.378"	.445"	0989	1.05	100
1/2"	.425"	.524"	0993	1.10	100
35/64"	.453"	.551"	0997	1.10	100
9/16"	.472"	.571"	0999	1.10	100
5/8"	.520"	.618"	1005	1.10	100
11/16"	.571"	.669"	1009	1.15	100
3/4"	.654"	.779"	1021	1.30	100
13/16"	.701"	.827"	1029	1.30	100

Pinch-On Clamp Service Kit

Includes:

- 15 of part #0709
- 15 of part #0811
- 15 of part #1113
- 15 of part #1315
- 15 of part #1518
- 12 of part #1720
- 12 of part #2023
- 12 of part #2225
- 12 of part #2327
- 1 pair of standard jaw pincers, part # 1098



Part #	Price/E
SK1098	\$208.00

Standard Jaw Pinch-On Clamp Tool

Part #	Price/E
1098	\$64.15



Side Jaw Pinch-On Clamp Tool

Part #	Price/E
1099	\$97.00



Dixon® Worm Gear Clamp Racks



CRWC



CR

Features:

- top load metal rack made of nickel plated steel rods with enameled steel sign
- sign identifies each clamp size and diameter range
- rack with clamps contains 9 clamp sizes with diameter ranges from 7/32" - 2-3/4"
- **CRWC**, Clamps included are:
 - 30 of part# MH4
 - 30 of part# MH6
 - 20 of part# HS10
 - 20 of part# HS12
 - 20 of part# HS20
 - 20 of part# HS24
 - 20 of part# HS28
 - 20 of part# HS32
 - 20 of part# HS36

Description	Part #	Price/E
with 200 clamps	CRWC	\$371.50
without clamps	CR	96.00

Quick Release Worm Gear Clamps



style LS



style LSS

- Torque ratings correspond to the torque rating of the screw of the clamp and *are not an indication of the working pressure of any hose assembly installed with this clamp.*



Style LS:

- screw: plated hardened carbon steel

Style LSS:

- screw: SAE 410 series stainless

Band Width	Hose OD		style LS		Pkg Qty	style LSS		Pkg Qty
	from	to	Part #	Price/E		Part #	Price/E	
1/2"	1-1/2"	3-1/2"	LS48	\$2.90	10	LSS48	\$4.60	10
	1"	4"	LS56	3.10	10	---	---	---
	2"	5"	LS72	3.60	10	LSS72	5.00	10
	2-1/16"	6"	LS88	4.20	10	LSS88	5.70	10
	3-1/2"	6-9/16"	LS96	4.10	---	---	---	---
	2-7/8"	7"	LS104	5.10	10	LSS104	6.25	10
	1-3/4"	8-9/16"	LS128	4.85	---	LSS128	6.10	---
	2"	10"	LS152	7.45	---	---	---	---
	2-1/16"	12-5/16"	LS188	6.00	---	LSS188	7.20	---
	10-3/16"	14"	---	---	---	LSS216	7.85	---
	1-3/4"	16"	---	---	---	LSS248	8.90	---
	1-7/8"	20"	---	---	---	LSS312	10.90	---

Worm Gear Make-A-Clamp Kits

Features:

- A maintenance clamp system in a box; by simply cutting off a piece of banding from a continuous roll, you can make any size stainless steel worm-driven clamp from 2" diameter and up. Perfect applications requiring for varying sized large clamps.
- reusable
- band width: 1/2"
- band thickness: .023"
- screw design: 5/16" slotted hex head
- band and housing material: 302 stainless
- screw material: 410 stainless

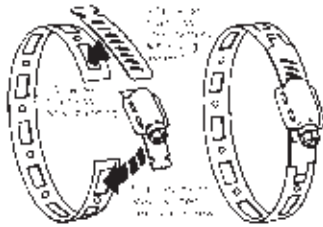

Contents	Stainless Steel	
	Part #	Price/E
mini kit: 8 1/2' band, 3 adjustable fasteners, 1 band splice	4000	\$27.50
kit with 100' band, 25 adjustable fasteners, 10 band splices	4001	216.70
kit with 50' band, 10 adjustable fasteners, 5 band splices	4002	108.25
box with 10 adjustable fasteners: priced per box	4004	45.40
box with 100' band, 10 band splices	4005	109.20
box with 50' band, 5 band splices	4006	59.30
6" demonstrator kit with clamps	4007	17.00
box with 10 band splices: priced per box	4008	25.75

T-Bolt Clamps

Features:

Style TBC

- can be applied with a standard 7/16" socket wrench
- ¾" wide, .025" thick, 300 series stainless steel band
- alloy steel bolt, torque rating: 70 in/lbs

Style STBC

- can be applied with a standard 7/16" socket wrench
- ¾" wide, .025" thick, 300 series stainless steel band
- 300 series stainless steel bolt, torque rating: 50 in/lbs

Hose OD		style TBC		style STBC		Optional Qty
from	to	Part #	Price/E	Part #	Price/E	
1.250"	1.406"	TBC131	\$10.20	STBC131	\$14.60	25
1.344"	1.562"	TBC150	7.60	STBC150	8.70	25
1.474"	1.692"	---	---	STBC163	8.70	25
1.594"	1.812"	TBC175	7.60	STBC175	8.70	25
1.724"	1.942"	TBC188	7.60	STBC188	8.70	25
1.844"	2.062"	TBC200	7.60	STBC200	8.70	25
1.964"	2.182"	---	---	STBC212	8.80	25
2.094"	2.312"	TBC225	7.60	STBC225	8.80	25
2.224"	2.442"	TBC238	7.60	STBC238	8.80	25
2.344"	2.562"	TBC250	7.80	STBC250	8.90	25
2.326"	2.622"	TBC256	7.40	STBC256	8.50	25
2.396"	2.692"	TBC263	7.40	STBC263	8.50	25
2.516"	2.812"	TBC275	7.40	STBC275	8.50	25
2.646"	2.942"	TBC288	7.50	STBC288	8.50	25
2.766"	3.062"	TBC300	7.50	STBC300	8.60	25
2.886"	3.182"	TBC312	7.60	STBC312	8.60	25
3.016"	3.312"	TBC325	7.60	STBC325	8.60	25
3.266"	3.562"	TBC350	7.90	STBC350	8.90	25
3.386"	3.682"	---	---	STBC362	8.90	25
3.516"	3.812"	TBC375	7.90	STBC375	8.90	25
3.586"	3.882"	TBC382	8.00	STBC382	8.90	25
3.766"	4.062"	TBC400	8.00	STBC400	8.90	25
4.016"	4.312"	TBC425	8.00	STBC425	9.00	25
4.266"	4.562"	TBC450	8.00	STBC450	9.00	25
4.516"	4.812"	TBC475	8.00	STBC475	9.60	25
4.766"	5.062"	TBC500	8.10	STBC500	9.80	25
5.016"	5.312"	TBC525	8.10	STBC525	9.80	25
5.266"	5.562"	TBC550	8.60	STBC550	10.30	25
5.516"	5.812"	TBC575	8.60	STBC575	10.30	25
5.766"	6.062"	TBC600	8.70	STBC600	10.30	25
6.016"	6.312"	TBC625	8.70	STBC625	10.30	25
6.266"	6.562"	TBC650	8.80	STBC650	10.30	25
6.516"	6.812"	TBC675	8.80	STBC675	10.30	25
6.766"	7.062"	TBC700	8.90	STBC700	10.70	25
7.016"	7.312"	---	---	STBC725	10.80	25
7.266"	7.562"	TBC750	8.90	STBC750	10.80	25
7.766"	8.062"	---	---	STBC800	11.10	25
8.016"	8.312"	---	---	STBC825	11.10	25
8.266"	8.562"	---	---	STBC850	11.10	25
8.646"	8.942"	---	---	STBC888	11.80	25
8.766"	9.062"	---	---	STBC900	11.80	25
9.266"	9.562"	---	---	STBC950	11.80	25
9.766"	10.062"	---	---	STBC1000	11.80	10
10.646"	10.942"	---	---	STBC1088	12.70	10
11.766"	12.062"	---	---	STBC1200	12.70	10
12.646"	12.942"	---	---	STBC1288	12.70	10



style TBC



style STBC



Heavy Duty T-Bolt Clamps



style HTBC



style HSTBC

Features:

- can be applied with a standard 1/2" socket wrench.
- 7/8" wide, .040" thick, 300 series stainless steel band
- style HTBC carbon steel bolt, torque rating: 150 in/lbs
- style HSTBC 300 series stainless steel bolt, torque rating: 150 in/lbs

Hose OD		style HTBC		style HSTBC	
from	to	Part #	Price/E	Part #	Price/E
2.125"	2.4375"	HTBC238	\$14.30	HSTBC238	\$16.20
2.250"	2.5625"	HTBC250	14.40	HSTBC250	16.30
2.750"	3.0625"	HTBC300	14.60	HSTBC300	16.50
3.250"	3.5625"	HTBC350	14.80	HSTBC350	16.80
3.750"	4.0625"	HTBC400	15.10	HSTBC400	17.00
4.250"	4.5625"	HTBC450	15.30	HSTBC450	17.30
4.750"	5.0625"	HTBC500	15.60	HSTBC500	17.50
5.250"	5.5625"	HTBC550	15.80	HSTBC550	17.80
5.750"	6.0625"	HTBC600	16.00	HSTBC600	18.00
6.250"	6.5625"	HTBC650	16.30	HSTBC650	18.30
6.750"	7.0625"	HTBC700	16.50	HSTBC700	18.40
7.250"	7.5625"	HTBC750	16.80	HSTBC750	18.80
7.750"	8.0625"	HTBC800	17.00	HSTBC800	19.10
8.266"	8.562"	---	---	HSTBC850	26.80
8.646"	8.942"	---	---	HSTBC888	27.20
8.766"	9.062"	---	---	HSTBC900	27.50
9.266"	9.562"	---	---	HSTBC950	28.30
9.766"	10.062"	---	---	HSTBC1000	29.00
10.646"	10.942"	---	---	HSTBC1088	30.50
12.646"	12.942"	---	---	HSTBC1288	33.40

Long Bolt T-Bolt Clamps

Features:

- can be applied with a standard 7/16" socket wrench.
- 3/4" wide, .025" thick, 300 series stainless steel band
- 300 series stainless steel bolt, torque rating: 50 in/lbs

Hose OD		300 series Stainless Steel		Optional
from	to	Part #	Price/E	Qty
2.80"	3.37"	STBC325L	\$12.00	25
3.05"	3.62"	STBC350L	12.00	25
3.37"	3.94"	STBC382L	12.00	25
3.55"	4.12"	STBC400L	12.10	25
3.75"	4.32"	STBC420L ¹	12.10	25
3.87"	4.44"	STBC432L	12.00	25
4.05"	4.62"	STBC450L	12.10	25
4.37"	4.94"	STBC482L	12.30	25
4.55"	5.12"	STBC500L	12.30	25
4.87"	5.44"	STBC532L	12.30	25
5.05"	5.62"	STBC550L	12.30	25
5.37"	5.94"	STBC582L	12.40	25
5.55"	6.12"	STBC600L ¹	12.50	25
5.87"	6.44"	STBC632L	12.50	25
6.05"	6.62"	STBC650L	12.60	25
6.30"	6.87"	STBC675L	12.60	25
6.53"	7.10"	STBC698L	12.70	25
6.55"	7.12"	STBC700L ¹	12.70	25
6.62"	7.19"	STBC707L	12.70	25
8.05"	8.62"	STBC850L	13.60	25
8.30"	8.87"	STBC875L	13.70	25
8.43"	9.00"	STBC888L	14.20	25
8.62"	9.19"	STBC907L	14.30	25
10.25"	10.82"	STBC1070L	14.30	25
10.43"	11.00"	STBC1088L	14.30	25
10.62"	11.19"	STBC1107L ¹	14.30	25
10.72"	11.29"	STBC1117L	16.90	25
12.20"	12.77"	STBC1265L	14.80	25
12.43"	13.00"	STBC1288L	14.80	25
12.75"	13.32"	STBC1320L	14.80	25
14.20"	14.77"	STBC1465L	14.90	25
14.43"	15.00"	STBC1488L	14.90	25
14.75"	15.32"	STBC1520L	15.20	25
16.20"	16.77"	STBC1665L	15.70	25
16.43"	17.00"	STBC1688L	15.70	25



¹ stock quantities only

Double Bolt Clamps

Features:

- inner surface has dual gripping ridges
- bolt lugs are reinforced to prevent bending out of alignment
- Torque values for clamps are based on dry bolts.
- The use of lubricant on bolts will adversely effect clamp performance.
- measure hose OD accurately before ordering clamps
- Consult Dixon® when using double bolt clamps on helical wire hose.



Hose OD		Plated Iron		Torque in ft. lbs.	Optional Qty
from	to	Part #	Price/E		
1-8/64"	1-12/64"	J48	\$7.55	15	100
1-12/64"	1-24/64"	J49	9.10	21	50
1-28/64"	1-34/64"	JX49	12.50	21	25
1-40/64"	1-52/64"	DL14	13.55	40	25
1-48/64"	2-3/64"	DL20	13.35	27	25
2-7/64"	2-19/64"	DL24¹	12.70	27	25
2-20/64"	2-40/64"	DL32¹	13.70	40	25
2-32/64"	2-48/64"	DL275	17.40	40	25
2-48/64"	3-4/64"	DL306	20.50	60	20
3-4/64"	3-24/64"	DL328	21.50	60	20
3-16/64"	3-32/64"	DL350	20.70	60	20

¹ investment cast carbon steel

Double Bolt Clamps with Saddles

Hose OD		Plated Iron		Torque in ft. lbs.	Optional Qty
from	to	Part #	Price/E		
3-32/64"	3-52/64"	400	\$21.00	40	25
3-50/64"	4-4/64"	431	25.10	40	20
4-2/64"	4-18/64"	463	22.95	40	20
4-16/64"	4-60/64"	525	26.70	60	10
4-32/64"	5-16/64"	550	29.00	60	10
5-8/64"	5-44/64"	600	31.55	60	10
5-44/64"	5-60/64"	639	35.15	60	10
5-60/64"	6-32/64"	675	34.15	60	10
6-32/64"	7-36/64"	769	39.25	60	10
7-44/64"	8-12/64"	818	55.50	125	5
8-16/64"	8-56/64"	875	56.00	125	5
8-60/64"	9-56/64"	988	65.60	125	5
9-60/64"	11-24/64"	1125	99.00	125	5
11-12/64"	13"	1275	110.20	125	3
12-12/64"	14"	1360	185.65	200	2
13-12/64"	15"	1450	180.00	200	2
15-4/64"	17-32/64"	1700	208.10	260	2



Single Bolt Clamps

Features:

- measure hose OD accurately before ordering clamps
- Torque values for clamps are based on dry bolts.
- The use of lubricant on bolts will adversely effect clamp performance.



Hose OD		Plated Iron		Torque in ft. lbs.
from	to	Part #	Price/E	
5/8"	1"	2	\$19.25	6
6/8"	1-8/64"	3	20.40	6
1-4/64"	1-12/64"	4	21.00	6
1-10/64"	1-16/64"	5	19.40	6
1-16/64"	1-24/64"	6	20.70	6
1-22/64"	1-28/64"	7	21.00	6
1-28/64"	1-36/64"	8	26.40	6
1-34/64"	1-44/64"	9	21.50	6
1-42/64"	1-48/64"	10	21.00	6
1-48/64"	1-56/64"	11	24.00	6
1-56/64"	2-2/64"	12	23.05	6
2"	2-8/64"	13	25.10	12
2-8/64"	2-18/64"	14	26.15	12
2-16/64"	2-26/64"	15	39.50	12
2-24/64"	2-32/64"	16	24.70	12
2-32/64"	2-40/64"	17	24.05	12
2-40/64"	2-56/64"	18	30.10	12
2-56/64"	3-4/64"	19	28.25	12
3-4/64"	3-16/64"	20	28.25	12
3-16/64"	3-28/64"	21	31.75	12
3-28/64"	3-40/64"	22	30.40	21
3-40/64"	3-52/64"	23	41.80	21
3-52/64"	4-8/64"	24	38.65	21
4-8/64"	4-20/64"	25	38.45	21
4-16/64"	4-32/64"	26	40.50	21
4-28/64"	4-40/64"	27	47.40	21
4-40/64"	4-56/64"	X27	41.00	21
4-56/64"	5-16/64"	28	47.00	21



Hydraulic Hose Clamps For 1 Wire Hose

Feature:

- for use only on 1 wire hydraulic hoses

Hose ID	Hose OD		Plated Iron		Torque in ft. lbs.
	from	to	Part #	Price/E	
3/8"	48/64"	50/64"	HD1-3	\$19.50	12
1/2"	56/64"	60/64"	HD1-4	18.30	18
3/4"	1-10/64"	1-14/64"	HD1-6	21.65	18
1"	1-29/64"	1-35/64"	HD1-8	26.10	36



Hydraulic Hose Clamps For 1 or 2 Wire Hose

Features:

- for use only on 1 or 2 wire hydraulic hoses
- This clamp *should not* be used on 4 or 6 wire hydraulic hose even when hose falls within recommended ranges.



Hose ID	Hose OD		Plated Iron		Torque in ft. lbs.
	from	to	Part #	Price/E	
3/8"	50/64"	52/64"	HRC-037	\$18.70	18
1/2"	57/64"	1"	HRC-050	20.60	18
3/4"	1-16/64"	1-20/64"	HRC-075	17.85	36
1"	1-37/64"	1-41/64"	HRC-100	24.10	64
1 1/4"	1-54/64"	1-62/64"	HRC-125	41.00	90
1 1/2"	2-10/64"	2-18/64"	HRC-150	41.40	90
2"	2-43/64"	2-52/64"	HRC-200	53.20	90



Spiral Clamps

Features:

- more than one clamp may be needed per size, contact the hose manufacturer for more information
- due to fluctuations in the OD of hose each individual installation should be checked 
- for use on convoluted cover hose
- To determine which style clamp is needed for your hose look at the end of the hose; if the helix spirals in a clockwise direction away from you (along the hose), a clockwise clamp is needed. If the helix spirals in a counterclockwise direction away from you, a counterclockwise clamp is needed. Examples include, but are not limited to: Kuriyama convoluted hose uses counter clockwise clamps; Pacific Echo and Kana Flex use clockwise clamps; Goodyear uses both counter clockwise and clockwise.

Clockwise



Size	Hose OD		Plated Steel, Right Hand	
	from	to	Part #	Price/E
1½"	1-34/64"	1-52/64"	SC150	\$12.70
2"	2-18/64"	2-32/64"	SC200	15.65
2½"	2-46/64"	3-8/64"	SC250	18.40
3"	3"	3-32/64"	SC300	19.40
4"	4"	4-32/64"	SC400	22.70
5"	5-6/64"	5-32/64"	SC500	29.35
6"	6-16/64"	7"	SC600	31.20
8"	8-32/64"	9-16/64"	SC800	37.60
10"	10-40/64"	11-16/64"	SC1000	47.10
12"	11-52/64"	12-61/64"	SC1200	56.00

Counter Clockwise Spiral Clamps



Size	Hose OD		Plated Steel, Left Hand	
	from	to	Part #	Price/E
1½"	1-34/64"	1-52/64"	SCCW150	\$12.70
2"	2-18/64"	2-32/64"	SCCW200	15.65
2½"	2-46/64"	3-8/64"	SCCW250	18.40
3"	3"	3-32/64"	SCCW300	19.40
4"	4"	4-32/64"	SCCW400	22.70
5"	5-6/64"	5-32/64"	SCCW500	29.35
6"	6-16/64"	7"	SCCW600	31.20
8"	8-32/64"	9-16/64"	SCCW800	37.60
10"	10-40/64"	11-16/64"	SCCW1000	49.40
12"	11-52/64"	12-61/64"	SCCW1200	56.00

Air King™ Clamps

Features:

- Torque values for clamps are based on dry bolts. The use of lubricant on bolts will adversely effect clamp performance. 
- for use with Air King™ ends on page G-2



Hose ID	Hose OD		Plated Iron		Torque ft. lbs.	Optional Qty
	from	to	Part #	Price/E		
½"	1"	1-12/64"	A4	\$8.60	6	50
¾"	1-8/64"	1-20/64"	A9 ²	9.85	21	50
1"	1-20/64"	1-32/64"	A10 ^{1,2}	12.75	21	50
1"	1-32/64"	1-52/64"	A14	17.50	21	50

¹ can be used with **AM6** and **AM11**

² global investment cast carbon steel

Short Crimp Sleeves

Features:

- for use with King™ Combination Nipples only
- a reliable alternative to band clamps
- not for use with Dixon® King Crimp™ Style Shanks



Hose ID	Hose OD		Sleeve ID	Sleeve Wall Thickness	Sleeve Overall Length	Carbon Steel		
	From	To				Part #	Price	
3/4"	1-5/64"	1-8/64"	1.1875"	.059"	1.25"	CSS075-3CS	\$4.90	
	1-5/64"	1-8/64"	1.1875"	.059"	2.138	CS075-3CS	4.90	
	1-9/64"	1-12/64"	1.250"	.059"	1.25"	CSS075-4CS	4.90	
	1-9/64"	1-12/64"	1.250"	.059"	2.138	CS075-4CS	4.90	
	1-17/64"	1-20/64"	1.375"	.059"	1.25"	CSS075-6CS	4.90	
	1-17/64"	1-20/64"	1.375"	.059"	2.138	CS075-6CS	4.90	
1"	1-21/64"	1-24/64"	1.438"	.062"	1 1/2"	CSS100-3CS	4.70	
	1-25/64"	1-28/64"	1.500"	.062"	1 1/2"	CSS100-4CS	4.70	
	1-29/64"	1-32/64"	1.563"	.062"	1 1/2"	CSS100-5CS	4.70	
	1-33/64"	1-36/64"	1.625"	.062"	1 1/2"	CSS100-6CS	4.70	
	1-37/64"	1-40/64"	1.688"	.062"	1 1/2"	CSS100-7CS	4.70	
	1-41/64"	1-44/64"	1.750"	.062"	1 1/2"	CSS100-8CS	4.70	
1 1/2"	1-41/64"	1-44/64"	1.750"	.062"	1 3/4"	CSS150-1CS	4.85	
	1-45/64"	1-48/64"	1.813"	.062"	1 3/4"	CSS150-2CS	4.85	
	1-49/64"	1-52/64"	1.875"	.062"	1 3/4"	CSS150-3CS	4.85	
	1-53/64"	1-56/64"	1.938"	.062"	1 3/4"	CSS150-4CS	4.85	
	1-57/64"	1-60/64"	2.000"	.062"	1 3/4"	CSS150-5CS	4.85	
	1-61/64"	2"	2.063"	.062"	1 3/4"	CSS150-6CS	4.85	
	2-1/64"	2-4/64"	2.125"	.062"	1 3/4"	CSS150-7CS	4.85	
	2-5/64"	2-8/64"	2.188"	.062"	1 3/4"	CSS150-8CS	4.85	
	2-9/64"	2-12/64"	2.250"	.062"	1 3/4"	CSS150-9CS	4.85	
2"	2-21/64"	2-24/64"	2.438"	.062"	2"	CSS200-3CS	5.70	
	2-25/64"	2-28/64"	2.500"	.062"	2"	CSS200-4CS	5.70	
	2-29/64"	2-32/64"	2.563"	.062"	2"	CSS200-5CS	5.70	
	2-33/64"	2-36/64"	2.625"	.062"	2"	CSS200-6CS	5.70	
	2-37/64"	2-40/64"	2.688"	.062"	2"	CSS200-7CS	5.70	
	2-41/64"	2-44/64"	2.750"	.062"	2"	CSS200-8CS	5.70	
	2-45/64"	2-48/64"	2.813"	.062"	2"	CSS200-9CS	5.70	
	2-49/64"	2-52/64"	2.875"	.062"	2"	CSS200-10CS	5.70	
	2-53/64"	2-56/64"	2.938"	.062"	2"	CSS200-11CS	5.70	
	2-57/64"	2-60/64"	3.000"	.062"	2"	CSS200-12CS	5.70	
	3"	3-13/64"	3-16/64"	3.313"	.090"	2 5/8"	CSS300-1CS	10.05
		3-17/64"	3-20/64"	3.375"	.090"	2 5/8"	CSS300-2CS	10.05
3-21/64"		3-24/64"	3.438"	.090"	2 5/8"	CSS300-3CS	10.05	
3-25/64"		3-28/64"	3.500"	.090"	2 5/8"	CSS300-4CS	10.05	
3-29/64"		3-32/64"	3.563"	.090"	2 5/8"	CSS300-5CS	10.05	
3-33/64"		3-36/64"	3.625"	.090"	2 5/8"	CSS300-6CS	10.05	
3-37/64"		3-40/64"	3.688"	.090"	2 5/8"	CSS300-7CS	10.05	
3-41/64"		3-44/64"	3.750"	.090"	2 5/8"	CSS300-8CS	10.05	
3-45/64"		3-48/64"	3.813"	.090"	2 5/8"	CSS300-9CS	10.05	
3-49/64"		3-52/64"	3.875"	.090"	2 5/8"	CSS300-10CS	10.05	
3-53/64"		3-56/64"	3.938"	.090"	2 5/8"	CSS300-11CS	10.05	
3-57/64"		3-60/64"	4.000"	.090"	2 5/8"	CSS300-12CS	10.05	
4"	4-29/64"	4-32/64"	4.563"	.090"	3-15/32"	CSS400-5CS	13.55	
	4-33/64"	4-36/64"	4.625"	.090"	3-15/32"	CSS400-6CS	13.55	
	4-37/64"	4-40/64"	4.688"	.090"	3-15/32"	CSS400-7CS	13.55	
	4-41/64"	4-44/64"	4.750"	.090"	3-15/32"	CSS400-8CS	13.55	
	4-45/64"	4-48/64"	4.813"	.090"	3-15/32"	CSS400-9CS	13.55	
	4-49/64"	4-52/64"	4.875"	.090"	3-15/32"	CSS400-10CS	13.55	
	4-53/64"	4-56/64"	4.938"	.090"	3-15/32"	CSS400-11CS	13.55	
	4-57/64"	4-60/64"	5.000"	.090"	3-15/32"	CSS400-12CS	13.55	



Notched Ferrules



- reference notched shanks on page E-5 and adapters on page D-24
- Dixon® stems and ferrules are specifically designed to be used together as a coupling system. Due to differences in dimensions and tolerances for safety reasons, do not use other manufacturer's stems or ferrules with Holedall™ products.



Size	Hose OD		304 Stainless Steel	
	From	To	Part #	Price/E
1½"	1-60/64"	2-12/64"	GAS2334NO	\$34.80
1½"	2-4/64"	2-22/64"	GAS2370NO	38.35
2"	2-30/64"	2-44/64"	GAS2709NO	31.80
2"	2-42/64"	2-54/64"	GAS2885NO	69.55
2½"	2-54/64"	3"	GAS3012NO	64.50
2½"	3-1/64"	3-13/64"	GAS3260NO	68.80
3"	3-30/64"	3-46/64"	GAS3760NO	45.40
3"	3-47/64"	3-54/64"	GAS3885NO	62.10
4"	4-40/64"	4-47/64"	GAS5010NO	258.75

Notched NOS Ferrules

- reference notched shanks on page E-5 and adapters on page D-24



Size	Hose OD		304 Stainless Steel	
	From	To	Part #	Price/E
1½"	1-60/64"	2-12/64"	GAS2334NOS	\$32.30
1½"	2-4/64"	2-22/64"	GAS2370NOS	34.50
2"	2-30/64"	2-44/64"	GAS2709NOS	31.50
2"	2-42/64"	2-54/64"	GAS2885NOS	65.00
3"	3-30/64"	3-46/64"	GAS3760NOS	46.35
3"	3-47/64"	3-54/64"	GAS3885NOS	63.00
4"	4-40/64"	4-47/64"	GAS5010NOS	235.00

Global Air King™ Ferrules

Features:

- low profile streamline appearance with maximum retention
- lightweight
- can be crimped
- designed for use with global Air King™ fittings on page G-3
- reference dixonvalve.com for crimp recommendations and ferrule OD ranges



Size	Ferrule ID	Plated Steel	
		Part #	Price
¾"	0.906"	CCF0906	\$1.15
	1.120"	CCF1120	1.55
	1.149"	CCF1149	1.55
	1.190"	CCF1190	1.55
	1.218"	CCF1218	1.55
	1.246"	CCF1246	1.55
1"	1.438"	CCF1438	2.35
	1.469"	CCF1469	2.35
	1.500"	CCF1500	2.35
	1.531"	CCF1531	2.35

Brass Ferrules for Air & Fluid

• sold in package quantities only

Ferrule ID	Ferrule Length	End Hole Size	Metal Gauge	Std Ind Part #	Bore/Crimp Diameter ¹	Previous Part #	Brass Part #	Price/E	Pkg Qty
.478"	.688	.328	.024"	4750	0.450	2004750C	BFM478	\$0.45	50
.500"	1	.344	.024"	7322	0.475	2005005C	BFM500	0.56	50
.528"	1	.375	.024"	7323	0.500	2005255C	BFM525	0.57	50
.528"	1	.438	.024"	7324	0.500	2005310C	BFM531	0.56	50
.562"	1	.438	.024"	7325	0.525	2005620C	BFM562	0.60	50
.593"	1	.438	.024"	7326	0.550	2005930C	BFM593	0.62	50
.625"	1	.438	.024"	7327	0.575	2006255C	BFM625	0.63	50
.656"	1	.438	.024"	7328	0.600	2006560C	BFM656	0.75	50
.687"	1	.500	.024"	7329	0.625	2006900C	BFM687	0.75	50
.718"	1	.625	.024"	7330	0.675	2007180C	BFM718	0.72	50
.718"	1	.500	.024"	7330B	0.675	---	BFM718B	0.72	50
.750"	1	.625	.024"	7331	0.700	2007505C	BFM750	0.79	50
.750"	1	.500	.024"	7331B	0.700	---	BFM750B	0.76	50
.781"	1	.625	.024"	7332	0.725	2007810C	BFM781	0.91	50
.781"	1	.500	.024"	7332B	0.725	---	BFM781B	0.93	50
.812"	1	.625	.024"	7333	0.750	2008120C	BFM812	0.95	50
.380"	.500	.266	.016"	622	0.350	---	BFL380	0.31	50
.400"	.469	.266	.020"	619	0.375	2004000C	BFL400	0.35	50
.410"	.500	.266	.016"	620	0.375	---	BFL410	0.32	50
.450"	.469	.344	.016"	769	0.425	2004530C	BFL450	0.32	50
.500"	.500	.344	.016"	624	0.450	2005000C	BFL500	0.33	50
.525"	.500	.344	.016"	625	0.475	2005250C	BFL525	0.33	50
.548"	.484	.375	.016"	626	0.500	2005500C	BFL548	0.34	50
.564"	.750	.375	.019"	3588	0.525	---	BFL564	0.45	50
.575"	.484	.469	.019"	KK	0.525	---	BFL575	0.36	50
.600"	.500	.500	.019"	JJ	0.550	---	BFL600	0.37	50
.625"	.500	.500	.019"	II	0.575	2006250C	BFL625	0.39	50
.650"	.500	.500	.019"	HH	0.600	2006500C	BFL650	0.40	50
.675"	.516	.500	.019"	GG	0.625	2006750C	BFL675	0.43	50
.725"	.531	.500	.019"	EE	0.675	2007250C	BFL725	0.43	50
.750"	.531	.500	.019"	DD	0.675	2007500C	BFL750	0.44	50
.775"	.531	.500	.016"	CC	0.700	2007750C	BFL775	0.67	50



BFM



BFL

- ¹ Plain die bore diameter can be used as crimp spec ±.005
- For use with ribbed and plain dies on page F-24

Brass Ferrules for Fluid

• sold in package quantities only

Ferrule ID	Ferrule Length	End Hole Size	Metal Gauge	Std Ind Part #	Ribbed Die*	Plain Die*	Bore/Crimp Diameter ¹	Previous Part #	Brass Part #	Price/E	Pkg Qty
.800"	.844"	.688"	.024"	---	R28	P29	0.750	---	BF800	\$0.78	25
.825"	.844"	.688"	.024"	---	R27	P28	0.775	---	BF825	0.77	25
.850"	.563"	.688"	.019"	Z	R26	P27	0.800	---	BF850	0.55	25
.875"	.844"	.688"	.024"	7244A	R25	P26	0.825	2008750C	BFW875	0.79	25
.900"	.844"	.688"	.024"	5029A	R24	P25	0.850	---	BFW900	0.83	25
.937"	.844"	.688"	.024"	7242A	R23	P24	0.875	2009250C	BFW925	1.05	25
.975"	.844"	.688"	.024"	5028A	R21	P22	0.925	2009750C	BFW975	1.05	25
1.025"	.844"	.693"	.024"	7114A	R19	P20	0.975	2001025C	BFW1025	1.10	25
1.175"	.844"	.875"	.024"	7088A	R13	P14	1.125	2001175C	BFW1175	1.20	25
1.050"	.625"	.750"	.025"	3605	R18	P19	1.000	---	BFMW1050	1.80	25
1.100"	.844"	.812"	.024"	5027A	R16	P17	1.050	2001100C	BFMW1100	1.25	25
1.150"	.844"	.875"	.024"	7104A	R15	P15	1.100	2009950C	BFMW1150	1.25	25
1.225"	.875"	.875"	.025"	875-K	R11	P12	1.175	2001225C	BFMW1225	1.85	25
1.275"	.875"	1.000"	.025"	875-I	R9	P10	1.225	---	BFMW1275	3.50	25
1.400"	.687"	1.125"	.019"	D	R4	P5	1.350	---	BFMW1400	3.55	25
1.500"	.875"	1.125"	.025"	1500	---	P1	1.450	2001500C	BFMW1500	2.50	25

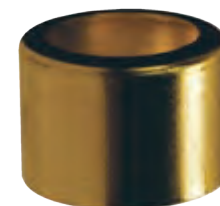

BFMW

- ¹ Plain die bore diameter can be used as crimp spec ±.005
- For use with ribbed and plain dies on page F-24

Ribbed and Plain Dies

Ferrule ID	Std Ind Part #	Bore/Crimp Diameter ¹	Ribbed Die*	Price/E	Plain Die*	Price/E
.478"	4750	0.450	R41	\$190.00	P42	\$190.00
.500"	7322	0.475	R40	190.00	P40	190.00
.528"	7323	0.500	R39	190.00	P39	190.00
.528"	7324	0.500	R39	190.00	P39	190.00
.562"	7325	0.525	R37	190.00	P38	190.00
.593"	7326	0.550	R36	190.00	P37	190.00
.625"	7327	0.575	R35	190.00	P36	190.00
.656"	7328	0.600	R34	190.00	P35	190.00
.687"	7329	0.625	R33	190.00	P34	190.00
.718"	7330	0.675	R31	190.00	P32	190.00
.718"	7330B	0.675	R31	190.00	P32	190.00
.750"	7331	0.700	R30	190.00	P31	190.00
.750"	7331B	0.700	R30	190.00	P31	190.00
.781"	7332	0.725	R29	190.00	P30	190.00
.781"	7332B	0.725	R29	190.00	P30	190.00
.812"	7333	0.750	R28	190.00	P29	190.00
.380"	622	0.350	R44	190.00	P45	190.00
.400"	619	0.375	R44	190.00	P44	190.00
.410"	620	0.375	R43	190.00	P44	190.00
.450"	769	0.425	R41	190.00	P42	190.00
.500"	624	0.450	R40	190.00	P41	190.00
.525"	625	0.475	R39	190.00	P40	190.00
.548"	626	0.500	R38	190.00	P39	190.00
.564"	3588	0.525	R37	190.00	P38	190.00
.575"	KK	0.525	R37	190.00	P38	190.00
.600"	JJ	0.550	R36	190.00	P37	190.00
.625"	II	0.575	R35	190.00	P36	190.00
.650"	HH	0.600	R34	190.00	P35	190.00
.675"	GG	0.625	R34	190.00	P34	190.00
.725"	EE	0.675	R31	190.00	P32	190.00
.750"	DD	0.675	R30	190.00	P32	190.00
.775"	CC	0.700	R31	190.00	P31	190.00
.800"	---	0.750	R28	190.00	P29	190.00
.825"	---	0.775	R27	190.00	P28	190.00
.850"	Z	0.800	R26	190.00	P27	190.00
.875"	7244A	0.825	R25	190.00	P26	190.00
.900"	5029A	0.850	R24	190.00	P25	190.00
.937"	7242A	0.875	R23	190.00	P24	190.00
.975"	5028A	0.925	R21	190.00	P22	190.00
1.025"	7114A	0.975	R19	190.00	P20	190.00
1.175"	7088A	1.125	R13	190.00	P14	190.00
1.050"	3605	1.000	R18	190.00	P19	190.00
1.100"	5027A	1.050	R16	190.00	P17	190.00
1.150"	7104A	1.100	R15	190.00	P15	190.00
1.225"	875-K	1.175	R11	190.00	P12	190.00
1.275"	875-l	1.225	R9	190.00	P10	190.00
1.400"	D	1.350	R4	190.00	P5	190.00
1.500"	1500	1.450	---	---	P1	190.00



P29



R28

¹ Plain die bore diameter can be used as crimp spec ±.005
 • dies for use with 5111A and 1765A ferrule machines. Other sizes are available.

Manually - Operated Brass Ferrule Crimper

Features:

- crimps all brass ferrules shown on page F-23
- does not include dies
- Dies for ferrule machines are available in standard sets for all ferrules as tabulated (4 segments to a set), supplied with plain or ribbed crimping surface
- height: 27" with handle upright
- base: 8" x 3"
- body: 7³/₈"

Part #	Price/E
5111A	\$1875.00



Air Operated Brass Ferrule Crimper

Features:

- provides efficient mass production assembly of hose, ferrules, and fittings
- The foot pedal permits the use of both hands, reduces fatigue and speeds production.
- complete with air cylinder, ferrule machine (less dies), fitted hose lengths and necessary control valves
- ready for work bench installation
- crimps all brass ferrules shown on page F-23

Part #	Price/E
1765A	\$8450.00



Die sizes for ferrules and machine numbers 1765A and 5111A are on page F-23.

Small Hose Crimpers



Features:

- Hose crimper provides "big tool" crimping advantages at a fraction of the cost.
- rugged, portable and easy to use
- 855 crimper with 5 dies for 31/64" (0.484") to 45/64" (0.703") OD hose
- 855A crimper with 5 dies for 28/64" (0.437") to 43/64" (0.671") OD hose
- optional dies up to 52/64" OD available

Previous Part #	Part #	Price/E
200FC	855	\$298.20
---	855A	309.20

Small Hose Crimper Dies



Die Bore	Hose OD		Crimper # 855	Crimper # 855A	Previous Part #	Die Part #	Price/E
	from	to					
.375"	.385"	.406"	optional	optional	200FC3	856-10	\$42.25
.437"	.447"	.468"	optional	standard	---	856-7	42.25
.484"	.490"	.520"	standard	standard	200FC4A	856-4	42.25
.531"	.540"	.562"	standard	standard	200FC4B	856-3	42.25
.578"	.590"	.625"	standard	standard	200FC5	856-2	42.25
.625"	.640"	.671"	standard	standard	200FC6A	856-1	42.25
.687"	.690"	.710"	standard	optional	200FC6B	856-5	42.25
.750"	.760"	.781"	optional	optional	200FC8A	856-8	42.25
.812"	.820"	.843"	optional	optional	200FC8B	856-9	42.25

Large Hose Crimper

Features:

- for crimping ½" to 1" ID hoses with larger OD's, from 11/16" to 1½"
- crimps standard brass or aluminum ferrules
- order separate dies for each hose diameter
- **Dies sold separately**



Crimper Part #	Price/E
860	\$330.00

Large Hose Crimper Dies

Hose OD/ Finished Crimp Dimension	Die Part #	Price/E
11/16"	861-22	\$49.00
23/32"	861-23	49.00
3/4"	861-24	49.00
25/32"	861-25	49.00
13/16"	861-26	49.00
27/32"	861-27	49.00
7/8"	861-28	49.00
29/32"	861-29	49.00
15/16"	861-30	49.00
31/32"	861-31	49.00
1"	861-32	49.00
1-1/32"	861-33	49.00
1-1/16"	861-34	49.00
1-1/8"	861-36	49.00
1-3/16"	861-38	49.00
1-1/4"	861-40	49.00
1-5/16"	861-42	49.00
1-3/8"	861-44	49.00
1-7/16"	861-46	49.00
1-1/2"	861-48	49.00



Universal Claw Fittings G-2 to G-9

Air King™	G-2
Global Air King™	G-3, G-4
4-lug Air King™	G-4
Air King™ with ferrule	G-5
Air King™ with gauge port	G-5
Air King™ universal swivels	G-5
Air King™ accessories	G-6
Sand Blast	G-7
Surelock™	G-8 to G-9

Quick Disconnects..... G-10 to G-43

Dix-Lock™ N-Series	G-10 to G-13
Dual-Lock™ P-Series	G-14 to G-16
Air Chief industrial	G-17, G-18, G-19
Dixon® key chain	G-18
Air Chief semi-auto	G-19
Air Chief automatic	G-20
Parker E-z-mate	G-21
Legris automatic safety couplers	G-22
Air Chief automotive	G-23 to G-24
Air Chief ARO interchange	G-25
Air Chief Lincoln interchange	G-26
DF-series	G-27 to G-31
J-series	G-32 to G-33
M-series	G-34 to G-35
CJ-series	G-36
SHD-series	G-37 to G-38
L-series	G-38
U-series	G-39
NK-series	G-40
BR-series	G-41 to G-42
A-series	G-42 to G-43

Steel 3500 nipples G-44**Swivel fittings G-45**

Bent stem & air tool swivel	G-45
-----------------------------------	------

Safety Cables..... G-46 to G-48

King Cable™	G-46
Nylon King Cable™	G-47
King™ safety whipsocks	G-48
King™ safety shackles	G-48
ASME air receiver manifold with King™ safety whipsock	G-48

Air Tanks and ManifoldsG-49 to G-51

ASME air receiver manifold	G-49, G-50
Manifolds	G-50, G-51
Compressor Y	G-51
Lubricants	G-51

FRL's..... G-52 to G-118

In-line lubricators	G-52, G-53
In-line filters	G-52, G-54
Non-repairable general purpose regulator	G-54
Blow guns	G-55 to G-59
Tire pressure gauges and inflator chucks	G-60
Wilkerson	G-61 to G-89
Miniatures	G-61 to G-64
Filters	G-65 to G-69
Manual in-line desiccant dryer	G-70
Regulators	G-70, G-71 to G-74
Filter / regulator	G-75, G-76
Lubricators	G-76, G-77 to G-78, G-79
Combination units	G-79, G-80 to G-82, G-83
Exhaust mufflers	G-83
Automatic drains	G-84
Lockout valves	G-84
Accessories	G-85 to G-89
Display	G-89
Series 1	G-90 to G-111
Display	G-90
Miniatures	G-90, G-91, G-92
Filters	G-92 to G-95
Regulators	G-96 to G-99
Filter / regulators	G-99, G-100
Lubricators	G-101 to G-104
Combination units	G-105
Accessories	G-106 to G-111
Watts	G-112 to G-118
Filters	G-112
Filter / regulators	G-113
Regulators	G-113, G-114
Lubricators	G-115
Combination units	G-116
Accessories	G-117 to G-118

Gauges G-119 to G-128

Dry	G-119 to G-120, G-121, G-122
Process	G-121
Panel builder	G-123
Contractor pressure	G-123
Compound	G-124
Vacuum	G-124



Gauges, cont G-119 to G-128

Liquid filled.....	G-125 to G-127
Dry	G-121 to G-122
Welding.....	G-128
Digital.....	G-128
180° steam gauge siphon.....	G-128

Thermometers G-129 to G-130

Bi-metal	G-129, G-130
Magnetic surface mount	G-130
Threaded thermowell.....	G-130

D.O.T Air Brake G-131 to G-142

Connectors	G-131
Male elbows.....	G-131
Tees	G-132
Legris.....	G-133 to G-136
Connectors.....	G-133
Unions.....	G-134
Elbows	G-134, G-135
Reducers.....	G-135
Tees	G-135, G-136
Air brake	G-137 to G-142
Connectors.....	G-137
Unions.....	G-138
Elbows	G-138, G-139
Tees	G-140
Sleeves	G-140
Accessories.....	G-141 to G-142

Push-in..... G-143 to G-161

Connectors	G-143
Unions	G-144
Elbows.....	G-144, G-145
Tees	G-145, G-146
Legris.....	G-147 to G-161
Connectors.....	G-147
Unions.....	G-147, G-148
Tees	G-148
Nickel-plated brass	G-149
Connectors	G-149
Unions	G-149
Elbows.....	G-150
Tees.....	G-150
Nylon / Nickel-plated brass	G-151 to G-153, G-155
Connectors	G-151
Elbows.....	G-152
Tees.....	G-153
Wyes	G-153

Push-in, cont G-143 to G-161

Nylon	G-154
Unions	G-154
Plugs	G-154
Tees.....	G-154
Wyes	G-154
Manifold	G-155
Fitting kit.....	G-155
Valves	G-156 to G-158
Ball	G-156
Quick Exhaust.....	G-156
Flow control.....	G-156 to G-157
Check	G-158
Metric.....	G-159 to G-161
Connectors.....	G-159, G-160, G-161
Elbows	G-159, G-161
Tees	G-160, G-161
Unions.....	G-160
Plugs.....	G-161

Swivel Fittings G-162

Ball	G-162
In-line	G-162

Mufflers and Vents G-163-G-164

Breather Vents.....	G-163
Mufflers.....	G-163-G-164
Conical	G-163
Speed control.....	G-164

⚠ WARNING

The constant vibration created by air tools, like air drills and pavement breakers, is destructive to air hose couplings, especially the quick-acting type. To provide protection against coupling breakage and related hazards, Dixon® recommends the use of a whip hose. To construct a whip hose, connect one end of a short (3' to 10') air hose to the air tool using a 3500 type steel nipple. Connect the other end of the hose to the air supply using the standard quick-acting coupling. The heat-treated 3500 nipple will withstand vibration far better than the standard coupling and provide a safer connection. The whip hose should remain permanently connected to the tool.

⚠ WARNING

- The use of an Air King™ safety clip or wire type retainer is necessary to ensure Air King™ universal couplings will not become accidentally disconnected. This guarantees the fittings are properly connected because the safety pin will not go through the holes in mating flanges until couplings are locked in place. Only one Air King™ safety clip or wire type retainer is required for each Air King™ universal coupling.

Air King™ Hose Ends

Features:

- can be used with Air King™ ferrules
- supplied with safety clip
- pressure rating: **150 PSI** at ambient temperature **70°F (21°C)**
- supplied with rubber washers, part # **AWR4**
- meets pressure requirements as specified in A-A-59553 commercial item description superseding Mil Spec. WWC-633D



Size	Iron		Optional Qty	Brass		Optional Qty	316 Stainless Steel	
	Part #	Price/E		Part #	Price/E		Part #	Price/E
3/8"	AMH ¹	\$10.40	25	ABH	\$38.95	25	RAMH	\$77.20
1/2"	AM1	7.45	50	AB1 ¹	24.10	50	RAM1	57.40
5/8"	AM5	11.15	50	AB5	26.20	50	---	---
3/4"	AM6	7.55	50	AB6 ¹	24.95	50	RAM6	48.25
1"	AM11	11.50	50	AB11 ¹	32.00	50	RAM11	53.35

Air King™ Male NPT Ends



Size	Iron		Optional Qty	Brass		Optional Qty	316 Stainless Steel	
	Part #	Price/E		Part #	Price/E		Part #	Price/E
1/4"	AMB1	\$10.75	25	ABB1	\$28.25	25	---	---
3/8"	AMB	9.50	25	ABB	32.30	25	RAMB	\$83.00
1/2"	AM2	8.65	50	AB2 ¹	26.10	50	RAM2	55.65
3/4"	AM7	8.70	50	AB7 ¹	25.80	50	RAM7	49.80
1"	AM12	9.20	50	AB12 ¹	26.80	50	RAM12	53.35

Air King™ Female NPT Ends



Size	Iron		Optional Qty	Brass		Optional Qty	316 Stainless Steel	
	Part #	Price/E		Part #	Price/E		Part #	Price/E
1/4"	AMC1	\$10.10	25	ABC1	\$29.70	25	---	---
3/8"	AMC	9.50	25	ABC	29.35	25	RAMC	\$83.85
1/2"	AM3	8.80	50	AB3 ¹	22.15	50	RAM3	57.40
3/4"	AM8	8.70	50	AB8 ¹	26.35	50	RAM8	49.80
1"	AM13	10.40	50	AB13 ¹	26.80	50	RAM13	55.90

Air King™ Blank Ends



Part #	Iron		Optional Qty	Brass		Optional Qty	316 Stainless Steel	
	Part #	Price/E		Part #	Price/E		Part #	Price/E
AM0	\$13.25	25	AB0 ¹	\$26.60	25	RAM0	\$51.80	

Air King™ Triple Connections



Part #	Iron		Optional Qty	Brass		Optional Qty
	Part #	Price/E		Part #	Price/E	
AM10	\$25.00	25	AB10 ¹	\$54.10	25	

¹ global investment cast

Air King™ is for air and water service only Warning: Never use any Air King™ coupling for steam service! None of Dixon®'s catalog information is to be interpreted to mean that this type of coupling is suitable for use on steam hose.



Feature:

- supplied with safety clip and rubber washers

Global Air King™ 4-Lug Hose Ends

Size	Plated Steel		Pkg Qty
	Part #	Price/E	
1/2"	GAM1	\$3.90	25
3/4"	GAM6	4.20	50
1"	GAM11	5.40	50



Global Air King™ Male NPT Ends

Size	Plated Steel		Pkg Qty
	Part #	Price/E	
1/2"	GAM2	\$4.35	25
3/4"	GAM7	4.75	50
1"	GAM12	5.40	50



Global Air King™ Female NPT Ends

Size	Plated Steel		Pkg Qty
	Part #	Price/E	
1/2"	GAM3	\$3.95	25
3/4"	GAM8	4.15	50
1"	GAM13	4.75	50



Global Air King™ Blank End

Part #	Plated Steel		Pkg Qty
	Part #	Price/E	
GAM0		\$4.40	25



Global Air King™ Triple Connection

Part #	Plated Steel		Pkg Qty
	Part #	Price/E	
GAM10		\$9.30	25



Air King™ is for air and water service only Warning: Never use any Air King™ coupling for steam service! None of Dixon®'s catalog information is to be interpreted to mean that this type of coupling is suitable for use on steam hose.



Features:

- supplied with safety clip and rubber washers
- pressure rating: **150 PSI** at ambient temperature **70°F (21°C)**
- use with Boss™ clamps, see pages C-10, C-11 
- not to be used for steam service
- must use safety clips, safety clips are same size for both 2-lug and 4-lug Air King™ couplings, see page G-6

Global Air King™ Hose Ends



Size	Plated Steel		Pkg Qty
	Part #	Price/E	
1¼"	GAM16	\$13.75	25
1½"	GAM21	15.80	25
2"	GAM26	19.20	10

Global Air King™ 4-Lug Female NPT Ends



Size	Plated Steel		Pkg Qty
	Part #	Price/E	
1¼"	GAM18	\$12.85	25
1½"	GAM23	13.80	25
2"	GAM28	15.20	20

Air King™ 4-Lug Hose Ends

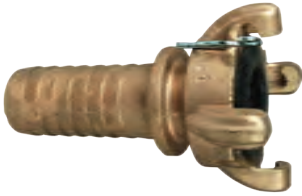

Size	Iron		Brass		Optional Qty
	Part #	Price/E	Part #	Price/E	
1¼"	AM16	\$28.35	AB16¹	\$63.50	25
1½"	AM21	29.40	AB21¹	65.80	25
2"	AM26	41.55	AB26	87.10	10

¹ item will be discontinued when stock is depleted

Air King™ 4-Lug Female NPT Ends



Size	Iron		Brass		Optional Qty
	Part #	Price/E	Part #	Price/E	
1¼"	AM18	\$28.35	AB18¹	\$72.50	25
1½"	AM23	26.90	AB23¹	72.80	25
2"	AM28	33.85	AB28	84.15	10

¹ item will be discontinued when stock is depleted

Air King™ is for air and water service only Warning: Never use any Air King™ coupling for steam service! None of Dixon®'s catalog information is to be interpreted to mean that this type of coupling is suitable for use on steam hose. 

Air King™ with Ferrule

Features:

- working pressure: **150 PSI** at ambient temperature **70°F (21°C)**
- design provides quick, easy and effective coupling of air hose
- interlocking ferrule can be crimped or swaged to achieve maximum coupling sealing and retention with a low profile streamline appearance, for crimp or swage diameter recommendations go to dixonvalve.com
- for air and water service only



Size	Hose OD		Iron		316 Stainless Steel	
	From	To	Part #	Price/E	Part #	Price/E
1/2"	5/4/64"	1-2/64"	AM1WF	\$15.30	RAM1WF	\$70.00
3/4"	1-4/64"	1-22/64"	AM6WF	12.50	RAM6WF	64.00
1"	1-18/64"	1-34/64"	AM11WF-1	22.00	---	---
1"	1-30/64"	1-46/64"	AM11WF	17.30	---	---



Air King™ with Gauge Port

Features:

- drilled with 1/4" NPT port for mounting a gauge
- gauge sold separately



Size	Iron		316 Stainless Steel	
	Part #	Price/E	Part #	Price/E
3/4"	AM7T	\$25.00	RAM7T	\$76.00

Air King™ Universal Swivel Hose End

Features:

- working pressure: **150 PSI** at ambient temperature **70°F (21°C)**
- interchanges with other Air King™ fittings
- includes a heavy-duty, free-turning joint that swivels under pressure to prevent hose kinking
- for air and water service only



Size	Iron	
	Part #	Price/E
3/4"	AM6SWIV	\$76.00

Air King™ Universal Swivel Male NPT Ends

Size	Iron	
	Part #	Price/E
1/2"	AM2SWIV	\$65.20
3/4"	AM7SWIV	66.00



Air King™ Universal Swivel Female NPT End

Size	Iron	
	Part #	Price/E
3/4"	AM8SWIV	\$69.40



Air King™ is for air and water service only Warning: Never use any Air King™ coupling for steam service! None of Dixon®'s catalog information is to be interpreted to mean that this type of coupling is suitable for use on steam hose.



Features:

- The use of an Air King™ safety clip or wire type retainer is necessary to ensure couplings will not become accidentally disconnected. This guarantees the fittings are properly connected as the pin will not go through the holes in the mating flanges until couplings are locked in place.
- only one Air King™ safety clip or wire type retainer is required for each Air King™ universal coupling
- sold in package quantities only

Standard Safety Clip

**Feature:**

- same size clip can be used for all coupling sizes

Wire Diameter	Part #	Price/E	Pkg Qty
.080	AC1	\$0.30	25

Air King™ Safety Pins

**Feature:**

- heavy duty, oversized

Wire Diameter	Part #	Price/E
.058	AKSP1	\$1.30
.091	AKSP25	1.45

Synthetic Lanyard

**Features:**

- synthetic cord
- same size for all coupling sizes

Part #	Price/E	Pkg Qty
ACL8	\$0.40	25

Air King™ 2-Lug Washers



AWR4

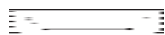

AWS6

**Features:**

- 2 lug couplings use the same size washer, part #'s **AWR4**, **AWS6**
- rubber temperature range: **-20°F to 160°F (-29°C to 71°C)**
- neoprene temperature range: **-20°F to 190°F (-29°C to 88°C)**
- neoprene is oil resistant

Material	Style	Part #	Price/E	Pkg Qty
<i>rubber</i>	2 lug	AWR4¹	\$0.60	50
<i>neoprene</i>	2 lug	AWS6	0.80	50

¹ made from Styrene-butadiene (SBR)

Air King™ 4-Lug Washer

**Features:**

- rubber temperature range: **-20°F to 160°F (-29°C to 71°C)**
- 4 lug couplings use the same size washer, part # **AWR14**

Material	Style	Part #	Price/E
<i>rubber</i>	4 lug	AWR14	\$4.40

Sand Blast Couplings

Features:

- designed for use on sand blast hose
- supplied with screws
- nozzle holders have 1 1/4" NPSM thread
- pressure: 110 PSI at ambient temperature **70°F (21°C)**
- abrasive blasting equipment must have hose safety cables (page G-46) or hose coupling safety locks installed to read safety clips



Installation:

- 1) Ends of hose must be cut square to fit snug against metal end.
- 2) Holding hose tight to end of fitting, insert screws and turn in full, putting screw 180° from first to ensure best centering.
- 3) After all screws have been placed, check tube opposite screws to be sure screws have not penetrated completely through.
- 4) On quick couplings, insert safety clips

Hose End

Hose Size	Hose OD	Brass		Aluminum	
		Part #	Price/E	Part #	Price/E
3/4"	1-1/2"	BSB75	\$49.00	ASB75	\$16.10
1"	1-7/8"	BSB100	49.75	ASB100	17.95
1 1/4"	2-5/32"	BSB125	88.75	ASB125	31.20
1 1/2"	2-3/8"	BSB150	99.50	ASB150	35.35



Nozzle Holders

Hose Size	Hose OD	Brass		Aluminum	
		Part #	Price/E	Part #	Price/E
3/4"	1-1/2"	BNH75	\$46.00	ANH75	\$14.75
1"	1-7/8"	BNH100	52.00	ANH100	16.80
1 1/4"	2-5/32"	BNH125	75.50	ANH125	22.10
1 1/2"	2-3/8"	BNH150	98.00	ANH150	29.25



Female Threaded End

Hose Size	Brass		Aluminum	
	Part #	Price/E	Part #	Price/E
1 1/4"	BSC125	\$54.50	ASC125	\$15.90
1 1/2"	BSC150	54.50	ASC150	15.90

- does not include screws



Sand Blast Replacement Parts

Description	Part #	Price/E
black nitrile replacement gasket	SBG	\$1.20
urethane replacement gasket	USBG	4.85
replacement screws (8 per bag only) part number is for one bag	SBCS	0.50



black nitrile



urethane

Surelock™ Couplings

Applications:

- multi-purpose coupling for water and air, commonly used in construction and mining; excels in services where ease, economy, safety and speed are paramount

Features:

- pressure activated gasket allows for easy coupling (less than 15 lbs. of force is required to connect the coupling gaskets seal upon introduction of line pressure)
- working pressure: **200 PSI** at ambient temperature **70°F (21°C)**
- body: SG iron AS1831 400-250-12
- bellow seal: natural rubber (patent pending), other seal material available upon request
- safety pin is supplied with each coupling and is required as a safety precaution



Hose Ends



Head	Size	Part#	Price/E	Pkg Qty
small	3/8"	SL038H	\$10.40	50
	1/2"	SL050H	12.25	50
	3/4"	SL075H	12.40	50
	1"	SL100H	14.50	50
medium	1 1/2"	SL150H	40.50	15
	2"	SL200H	48.50	10

Male NPT Ends



Head	Size	Part#	Price/E	Pkg Qty
small	3/8"	SL038M	\$14.40	50
	1/2"	SL050M	14.20	50
	3/4"	SL075M	13.60	50
	1"	SL100M	13.90	50
medium	1 1/2"	SL150M	40.00	15
	2"	SL200M	42.00	15

Female NPT Ends



Head	Size	Part#	Price/E	Pkg Qty
small	3/8"	SL038F	\$14.20	50
	1/2"	SL050F	14.90	50
	3/4"	SL075F	12.80	50
	1"	SL100F	14.20	50
medium	1 1/2"	SL150F	37.50	15
	2"	SL200F	38.25	15

Hose End with Ferrules

Features:

- design provides quick, easy and effective coupling of air hose
- interlocking ferrule can be crimped or swaged to achieve maximum coupling sealing and retention with a low profile streamline appearance, visit dixonvalve.com for crimp recommendations
- Dixon® recommends that all hose assemblies be tested in accordance with ARPM testing procedures.
- working pressure: **200 PSI** at ambient temperature **70°F (21°C)**
- for air and water service only



Head	Size	Hose OD		Part #	Price/E
		From	To		
small	1/2"	1/2"	1-1/32"	SL050CR	\$16.40
	3/4"	3/4"	1-11/32"	SL075CR	17.90
	1"	1"	1-23/32"	SL100CR	19.00

Blank Ends

Head	Size	Part #	Price/E	Pkg Qty
small	½" to 1"	SL00	\$13.40	15
medium	1½" to 2"	SL01	49.00	3

¹ medium blank end comes with 1" NPT pipe plug



small blank end



medium blank end ¹

Three Way Connectors

Head	Size	Part #	Price/E	Pkg Qty
small	½" to 1"	SL09	\$35.50	15
medium	1½" to 2"	SL10	139.00	3

¹ medium three way connector comes with 1" NPT pipe plug



small three way connector



medium three way connector ¹

Replacement Seals

Head	Size	Part #	Price/E	Pkg Qty
small	½" to 1"	SLR1	\$1.60	1
medium	1½" to 2"	SLR2	1.90	1



medium

Safety Locking Pin

The use of a safety locking pin is necessary to ensure that Surelock™ couplings will not become accidentally disconnected. This guarantees that the fittings are properly connected as the pin will not go through the holes in both couplings until the couplings are locked into place.



Part #	Price/E	Pkg Qty
SLP1	\$0.32	25

Dix-Lock™ N-Series Bowes Interchange Pneumatic Couplings

Features:

- temperature range: **-40°F to 250°F (-40°C to 121°C)**
- pressure rating: 300 PSI in brass, 500 PSI in steel and 303 stainless steel at ambient temperature **70°C (21°C)**
- Bowes Interchange Bayonet Style
- Interchangeable with Bowes 51000-Series, National Series 'B', MacDonald Quick-Action, Campbell Single-Lock
- conforms to MIL-C-3486 and A-A-50431A standards

It is important to be safe when installing quick disconnect couplings into a pneumatic circuit. Never install a pneumatic coupling directly into an air tool, use a piece of hose that is at least 18" long, between the tool and the coupling, to prevent damage to the coupling. To protect the operator, safety devices, such as a safety check valve and safety cable should be installed in case there is a hose or coupling failure. For safety cables and check valves see pages G-46 and I-26. 

Dix-Lock™ N-Series Bowes Interchange Female Thread Couplers



303 stainless

Body Size	Threads	Brass			Steel			303 Stainless Steel		
		Previous Part #	Part #	Price/E	Previous Part #	Part #	Price/E	Previous Part #	Part #	Price/E
1/2"	3/8"-18 NPTF	QB101	4NF3-B	\$28.94	QM101	4NF3	\$19.35	---	---	---
	3/8"-19 BSPP	---	---	---	---	4NBF3	19.35	---	---	---
	1/2"-14 NPTF	QB102	4NF4-B	28.94	QM102	4NF4	19.35	---	---	---
	1/2"-14 BSPP	---	4NBF4-B	28.94	---	4NBF4	19.35	---	---	---
	3/4"-14 NPTF	QB103	4NF6-B	28.94	QM103	4NF6	19.35	QSS103	4NF6-S	\$59.29
	3/4"-14 BSPP	---	4NBF6-B	28.94	---	4NBF6	19.35	---	---	---
	1"-11 1/2 NPTF	QB105	4NF8-B	31.77	QM105	4NF8	21.32	---	---	---
	1"-11 BSPP	---	4NBF8-B	31.77	---	4NBF8	21.32	---	---	---

Dix-Lock™ N-Series Bowes Interchange Female Thread Plugs



303 stainless

Body Size	Threads	Brass			Steel			303 Stainless Steel		
		Previous Part #	Part #	Price/E	Previous Part #	Part #	Price/E	Previous Part #	Part #	Price/E
1/2"	3/8"-18 NPTF	QB81	N4F3-B	\$37.61	QM81	N4F3	\$23.88	---	---	---
	3/8"-19 BSPP	---	---	---	---	N4BF3	23.88	---	---	---
	1/2"-14 NPTF	QB82	N4F4-B	37.61	QM82	N4F4	23.88	---	---	---
	1/2"-14 BSPP	---	N4BF4-B	37.61	---	N4BF4	23.88	---	---	---
	3/4"-14 NPTF	QB83	N4F6-B	37.61	QM83	N4F6	23.88	QSS83	N4F6-S	\$80.96
	3/4"-14 BSPP	---	N4BF6-B	37.61	---	N4BF6	23.88	---	---	---
	1"-11 1/2 NPTF	QB85	N4F8-B	39.26	QM85	N4F8	26.43	---	---	---
	1"-11 BSPP	---	N4BF8-B	39.26	---	N4BF8	26.43	---	---	---

Dix-Lock™ N-Series Bowes Interchange Female Thread Safety-Lock Plugs



Body Size	Threads	Brass	
		Part #	Price/E
1/2"	1/2" - 14 NPTF	N4F4-B-LS	\$41.76
	3/4" - 14 NPTF	N4F6-B-LS	41.76

Dix-Lock™ N-Series Bowes Interchange Male Thread Couplers

Body Size	Threads	Brass			Steel			303 Stainless Steel		
		Previous Part #	Part #	Price/E	Previous Part #	Part #	Price/E	Previous Part #	Part #	Price/E
3/8"	1/2" - 14 NPTF	---	---	---	QM60	3NM4	\$42.41	---	---	---
	1/2" - 14 BSPT	---	---	---	---	3NBM4	42.41	---	---	---
1/2"	3/8" - 18 NPTF	QB61	4NM3-B	\$28.94	QM61	4NM3	19.35	---	---	---
	3/8" - 19 BSPT	---	---	---	---	4NBM3	19.35	---	---	---
	1/2" - 14 NPTF	QB62	4NM4-B	28.94	QM62	4NM4	19.35	---	---	---
	1/2" - 14 BSPT	---	4NBM4-B	28.94	---	4NBM4	19.35	---	---	---
	3/4" - 14 NPTF	QB63	4NM6-B	28.94	QM63	4NM6	19.35	QSS63	4NM6-S	\$59.43
	3/4" - 14 BSPT	---	4NBM6-B	28.94	---	4NBM6	19.35	---	---	---
	1" - 11 1/2 NPTF	QB65	4NM8-B	31.65	QM65	4NM8	34.61	---	---	---
1" - 11 BSPT	---	4NBM8-B	31.77	---	4NBM8	34.61	---	---	---	



brass



steel



303 stainless

Pneumatic Fittings

Dix-Lock™ N-Series Bowes Interchange Male Thread Plugs

Body Size	Threads	Brass			Steel			303 Stainless Steel		
		Previous Part #	Part #	Price/E	Previous Part #	Part #	Price/E	Previous Part #	Part #	Price/E
3/8"	1/2"-14 NPTF	---	---	---	QM40	N3M4	\$51.46	---	---	---
	1/2"-14 BSPT	---	---	---	---	N3BM4	51.46	---	---	---
1/2"	3/8"-18 NPTF	QB41	N4M3-B	\$36.07	QM41	N4M3	24.68	---	---	---
	3/8"-19 BSPT	---	---	---	---	N4BM3	24.68	---	---	---
	1/2"-14 NPTF	QB42	N4M4-B	36.07	QM42	N4M4	24.68	---	---	---
	1/2"-14 BSPT	---	N4BM4-B	36.07	---	N4BM4	24.68	---	---	---
	3/4"-14 NPTF	QB43	N4M6-B	36.07	QM43	N4M6	24.68	QSS43	N4M6-S	\$80.96
	3/4"-14 BSPT	---	N4BM6-B	36.07	---	N4BM6	24.68	---	---	---
	1"-11 1/2 NPTF	QB45	N4M8-B	37.73	QM45	N4M8	26.43	---	---	---
1"-11 BSPT	---	N4BM8-B	37.73	---	N4BM8	26.43	---	---	---	



brass



steel



303 stainless

Dix-Lock™ N-Series Bowes Interchange Male Thread Safety-Lock Plugs

Body Size	Threads	Brass			Steel			303 Stainless Steel	
		Previous Part #	Part #	Price/E	Previous Part #	Part #	Price/E	Part #	Price/E
1/2"	1/2"-14 NPTF	QB66	N4M4-B-LS	\$43.86	QM66	N4M4-LS	\$32.72	---	---
	1/2"-14 BSPT	---	---	---	---	N4BM4-LS	32.72	---	---
	3/4"-14 NPTF	QB88	N4M6-B-LS	43.86	QM88	N4M6-LS	32.72	N4M6-S-LS	\$129.45
	3/4"-14 BSPT	---	---	---	---	N4BM6-LS	32.72	---	---



brass



steel



303 stainless

Dix-Lock™ N-Series Bowes Interchange Coupler Thread Standard Hose Barbs

Body Size	Hose ID	Brass			Steel			303 Stainless Steel		
		Previous Part #	Part #	Price/E	Previous Part #	Part #	Price/E	Previous Part #	Part #	Price/E
3/8"	1/2"	---	---	---	QM20	3NCS4	\$47.72	---	---	---
1/2"	3/8"	QB21	4NS3-B	\$28.94	QM21	4NS3	19.35	---	---	---
	1/2"	QB22	4NS4-B	28.94	QM22	4NS4	19.35	---	---	---
	3/4"	QB23	4NS6-B	28.94	QM23	4NS6	19.35	QSS23	4NS6-S	\$59.43
	1"	QB25	4NS8-B	31.77	QM25	4NS8	21.32	---	4NS8-S	80.89



brass



steel



303 stainless

Pneumatic Fittings



brass



steel



303 stainless

Dix-Lock™ N-Series Bowes Interchange Hose Barb Plugs

Body Size	Hose ID	Brass			Steel			303 Stainless Steel		
		Previous Part #	Part #	Price/E	Previous Part #	Part #	Price/E	Previous Part #	Part #	Price/E
3/8"	1/2"	---	---	---	QM1	N3CS4	\$54.58	---	---	---
	3/8"	QB2	N4S3-B	\$40.21	QM2	N4S3	23.41	---	---	---
1/2"	1/2"	QB3	N4S4-B	40.21	QM3	N4S4	23.88	---	---	---
	3/4"	QB4	N4S6-B	40.21	QM4	N4S6	23.88	QSS4	N4S6-S	\$80.96
	1"	QB5	N4S8-B	40.79	QM5	N4S8	26.43	---	N4S8-S	99.46

Dix-Lock™ N-Series Bowes Interchange Hose Barb Safety-Lock Plugs



brass



steel



303 stainless

Body Size	Hose ID	Brass			Steel			303 Stainless Steel	
		Previous Part #	Part #	Price/E	Previous Part #	Part #	Price/E	Part #	Price/E
1/2"	1/2"	QB33	N4S4-B-LS	\$43.86	QM33	N4S4-LS	\$32.72	---	---
	3/4"	QB44	N4S6-B-LS	43.86	QM44	N4S6-LS	31.87	N4S6-S-LS	\$129.45

Dix-Lock™ N-Series Bowes Interchange Union



Body Size	Configuration	Previous Part #	Steel	
			Part #	Price/E
1/2"	coupler to coupler	QM0	4N4N	\$64.03

Dix-Lock™ N-Series Bowes Interchange Caps



Body Size	Cap Lanyard	Brass			Steel		
		Previous Part #	Part #	Price/E	Previous Part #	Part #	Price/E
1/2"	steel cable	QBCAP	N4DC-B	\$26.06	QMCAP	N4DC	\$22.69

Dix-Lock™ N-Series Bowes Interchange Seals



Body Size	Coupler Style	Previous Part #	Nitrile		FKM	
			Part #	Price/E	Part #	Price/E
3/8"	all	QBM1	3N-SKIT	\$1.39	---	---
1/2"	all	QBM2	4N-SKIT	1.39	F-4N-SKIT	\$2.95

Features:

- working pressure: **300 PSI** at ambient temperature **70°F (21°C)**
- for crimp recommendations visit dixonvalve.com
- also available in stainless steel, contact Dixon® for further information

Materials:

- machined components are manufactured using solid steel, brass, or 303 stainless steel bar stock
- stainless steel retaining ring and spring maximize corrosion resistance and extend service life
- steel componentry is plated using ROHS Compliant Trivalent Chrome

Interchange Data:

- Bowes Interchange Bayonet Style
- interchangeable with Bowes 51000-Series, National Series 'B', MacDonald Quick-Action, Campbell Single-Lock

Seal Components:

- Nitrile (Buna-N) pneumatically energized seals are standard, temperature range **-40°F to 250°F (-40°C to 121°C)**

Dix-Lock™ N-Series Bowes Interchange Coupler with Ferrule Female Head

Body Size	Hose ID	Hose OD		Plated Steel			Brass		
		From:	To:	Previous Part #	Part #	Price/E	Previous Part #	Part #	Price/E
1/2"	1/2"	54/64"	1-2/64"	QM22WF	4NS4-WF	\$26.60	QB22WF	4NS4-B-WF	\$36.60
	3/4"	1-10/64"	1-22/64"	QM23WF	4NS6-WF	26.60	QB23WF	4NS6-B-WF	36.60



Dix-Lock™ N-Series Bowes Interchange Coupler with Ferrule Male Head

Body Size	Hose ID	Hose OD		Plated Steel			Brass		
		From:	To:	Previous Part #	Part #	Price/E	Previous Part #	Part #	Price/E
1/2"	1/2"	54/64"	1-2/64"	QM33WF	N4S4-WF	\$33.20	QB3WF	N4S4-B-WF	\$50.20
	3/4"	1-10/64"	1-22/64"	QM44WF	N4S6-WF	33.20	QB4WF	N4S6-B-WF	50.20



Dix-Lock™ N-Series Bowes Interchange Coupler with Ferrule Male Locking Head

Body Size	Hose ID	Hose OD		Plated Steel			Brass		
		From:	To:	Previous Part #	Part #	Price/E	Previous Part #	Part #	Price/E
1/2"	1/2"	54/64"	1-2/64"	QM33WF	N4S4-LS-WF	\$41.60	QB33WF	N4S4-B-LS-WF	\$52.90
	3/4"	1-10/64"	1-22/64"	QM44WF	N4S6-LS-WF	41.60	QB44WF	N4S6-B-LS-WF	52.90



Dual-Lock™ P-Series Pneumatic Couplings

Features:

- interchanges with National A type, Campbell Double-Lock and Thor PHC series couplings
- spring loaded interlocking engagement
- optional locking key prevents sleeve retraction
- working pressure: **300 PSI** at ambient temperature **70°F (21°C)**
- Nitrile (Buna-N) seals are standard temperature range **-40°F to 250°F (-40°C to 121°C)**
- steel componentry is plated using ROHS compliant trivalent chrome

Dual-Lock™ P-Series Thor Interchange Female Thread Couplers



brass



steel



303 stainless

Body Size	Threads	Brass		Steel			303 Stainless Steel		
		Part #	Price/E	Previous Part #	Part #	Price/E	Previous Part #	Part #	Price/E
1/2"	1/2" - 14 NPTF	---	---	PFL8	4PF4	\$37.96	---	---	---
	3/4" - 14 NPTF	4PF6-B	\$80.19	PFL12	4PF6	37.96	PFL12SS	4PF6-S	\$273.53

Dual-Lock™ P-Series Thor Interchange Female Thread Plugs



brass



steel



303 stainless

Body Size	Threads	Brass			Steel			303 Stainless Steel		
		Previous Part #	Part #	Price/E	Previous Part #	Part #	Price/E	Previous Part #	Part #	Price/E
1/2"	3/8" - 18 NPTF	---	---	---	PF6	P4F3	\$22.74	---	---	---
	1/2" - 14 NPTF	PFB8	P4F4-B	\$62.87	PF8	P4F4	24.63	---	---	---
	3/4" - 14 NPTF	PFB12	P4F6-B	61.29	PF12	P4F6	24.74	PF12SS	P4F6-S	\$141.52
	3/4" - 14 NPTF	---	---	---	---	P4F6-9¹	50.39	---	---	---
	1" - 11 1/2 NPTF	PFB16	P4F8-B	63.47	PF16	P4F8	26.94	---	---	---

¹ steel/PTFE coating

Dual-Lock™ P-Series Thor Interchange Male Thread Couplers



steel



303 stainless

Body Size	Threads	Steel			303 Stainless Steel		
		Previous Part #	Part #	Price/E	Previous Part #	Part #	Price/E
1/2"	3/8" - 18 NPTF	PML6	4PM3	\$33.33	---	---	---
	1/2" - 14 NPTF	PML8	4PM4	33.15	---	---	---
	3/4" - 14 NPTF	PML12	4PM6	33.15	PML12SS	4PM6-S	\$285.84
	3/4" - 14 NPTF	---	4PM6-9¹	74.26	---	---	---
	1" - 11 1/2 NPTF	---	4PM8	81.16	---	---	---

¹ steel/PTFE coating

Dual-Lock™ P-Series Thor Interchange Male Thread Plugs

Body Size	Threads	Brass			Steel			303 Stainless Steel		
		Previous Part #	Part #	Price/E	Previous Part #	Part #	Price/E	Previous Part #	Part #	Price/E
1/2"	3/8"-18 NPTF	---	---	---	PM6	P4M3	\$19.72	---	---	---
	1/2"-14 NPTF	PMB8	P4M4-B	\$58.78	PM8	P4M4	19.35	---	---	---
	3/4"-14 NPTF	PMB12	P4M6-B	\$63.47	PM12	P4M6	20.32	PM12SS	P4M6-S	\$141.52
	3/4"-14 NPTF	---	---	---	---	P4M6-9¹	50.39	---	---	---
	1"-11 1/2 NPTF	PMB16	P4M8-B	63.47	PM16	P4M8	22.78	---	---	---

¹ steel/PTFE coating



brass



steel



303 stainless

Dual-Lock™ P-Series Thor Interchange Hose Barb Couplers

Body Size	Hose ID	Brass			Steel			303 Stainless Steel		
		Previous Part #	Part #	Price/E	Previous Part #	Part #	Price/E	Previous Part #	Part #	Price/E
1/2"	3/8"	---	---	---	PHL6	4PS3	\$35.23	---	---	---
	1/2"	---	4PS4-B	\$72.70	PHL8	4PS4	35.23	---	---	---
	3/4"	PHLB12	4PS6-B	82.73	PHL12	4PS6	37.22	PHL12SS	4PS6-S	\$327.82
	3/4"	---	---	---	---	4PS6-9¹	115.64	---	---	---
	1"	PHLB16	4PS8-B	90.21	PHL16	4PS8	56.71	---	---	---

¹ steel/PTFE coating



brass



steel



303 stainless

Dual-Lock™ P-Series Thor Interchange Hose Barb Coupler with Knurled Flanged Sleeves

Feature:

- large, raised collar sleeve permits easier handling when wearing gloves

Body Size	Hose ID	Trivalent Chrome Plated Steel		
		Previous Part #	Part #	Price/E
1/2"	3/8"	PHL6FS	4PS3-FS	\$38.88
	1/2"	PHL8FS	4PS4-FS	38.88
	3/4"	PHL12FS	4PS6-FS	40.87



Dual-Lock™ P-Series Thor Interchange Male Thread Coupler with Knurled Flanged Sleeves

Body Size	Threads	Trivalent Chrome Plated Steel		
		Previous Part #	Part #	Price/E
1/2"	3/8"-18 NPTF	PML6FS	4PM3-FS	\$36.98
	1/2"-14 NPTF	PML8FS	4PM4-FS	36.80
	3/4"-14 NPTF	PML12FS	4PM6-FS	36.80



Dual-Lock™ P-Series Thor Interchange Female Thread Couplers with Knurled Flanged Sleeves

Body Size	Threads	Trivalent Chrome Plated Steel		
		Previous Part #	Part #	Price/E
1/2"	1/2"-14 NPTF	PFL8FS	4PF4-FS	\$41.61
	3/4"-14 NPTF	PFL12FS	4PF6-FS	41.61



Dual-Lock™ P-Series Thor Interchange Replacement Seals



Body Size	Coupler Style	Nitrile		Previous Part #	FKM	
		Part #	Price/E		Part #	Price/E
1/2"	all	4P-SKIT	\$2.63	452963	F-4P-SKIT	\$6.54

Thor Interchange Locking Key



Body Size	Coupler Style	Previous Part #	Steel	
			Part #	Price/E
1/2"	all	855231	4P-CLIP	\$1.76

- fits couplings with locking sleeve

Dual-Lock™ P-Series Thor Interchange Couplers with Ferrule

Features:

- working pressure: **300 PSI** at ambient temperature **70°F (21°C)**
- for crimp recommendations see dixonvalve.com
- 3/8" and 1" sizes available upon request, contact Dixon®

Materials:

- machined components are manufactured using solid steel, brass, or 303 stainless steel bar stock
- stainless steel retaining ring and spring maximize corrosion resistance and extend service life
- steel componentry is plated using ROHS Compliant Trivalent Chrome
- steel couplings have a zinc cast sleeve

Interchange Data:

- Thor Finger-Lock Interchange
- Interchanges with Thor PHC-Series, National Series 'A', and Campbell Double-Lock

Seal Components:

- Nitrile (Buna-N) seals standard, temperature range **-40°F to 250°F (-40°C to 121°C)**



Body Size	Hose ID	Hose OD		Trivalent Chrome Plated Steel		
		From:	To:	Previous Part #	Part #	Price/E
1/2"	1/2"	54/64"	1-2/64"	PHL8WF	4PS4-WF	\$42.00
	3/4"	1-10/64"	1-22/64"	PHL12WF	4PS6-WF	43.95

Air Chief Industrial Interchange Couplings

Features:

- pressure rating: **300 PSI**
- temperature range: **-40°F to 250°F (-40°C to 121°C)**
- interchanges with many other manufacturer's designs
- interchanges with MIL Spec. MIL-C-4109F/A-A-59439
- for air service only 

Female Plugs

Body Size	Female NPT	Flow Rating at 100 PSI	Steel	
			Part #	Price/E
1/4"	1/8"	37 CFM	DCP2021	\$3.80
	1/4"	37 CFM	DCP20	3.05
	3/8"	37 CFM	DCP2023	6.20
3/8"	1/4"	70 CFM	DCP2622	5.00
	3/8"	70 CFM	DCP26	5.65
	1/2"	70 CFM	DCP2624	10.75
1/2"	3/8"	150 CFM	DCP1823	10.50
	1/2"	150 CFM	DCP18	9.25
	3/4"	150 CFM	DCP1826	15.80
3/4"	1/2"	200 CFM	DCP7024	17.55
	3/4"	200 CFM	DCP7026	19.20
	1"	200 CFM	DCP7028	34.85

- see brass and stainless steel on page G-27



Male Plugs

Body Size	Male NPT	Flow Rating at 100 PSI	Steel	
			Part #	Price/E
1/4"	1/8"	37 CFM	DCP2101	\$3.00
	1/4"	37 CFM	DCP21	2.65
	3/8"	37 CFM	DCP2103	4.25
3/8"	1/4"	70 CFM	DCP2502	4.50
	3/8"	70 CFM	DCP25	4.50
	1/2"	70 CFM	DCP2504	9.25
1/2"	3/8"	150 CFM	DCP1703	7.60
	1/2"	150 CFM	DCP17	7.50
	3/4"	150 CFM	DCP1706	14.15
3/4"	1/2"	200 CFM	DCP7104	16.00
	3/4"	200 CFM	DCP7106	16.25
	1"	200 CFM	DCP7108	25.30



Features:

- pressure rating: **300 PSI**
- temperature range: **-40°F to 250°F (-40°C to 121°C)**
- interchanges with many other manufacturer's designs
- interchanges with MIL Spec. MIL-C-4109F/A-A-59439
- for air service only 

Standard Hose Barb Plugs



DCP7145

Body Size	Hose ID	Flow Rating at 100 PSI	Steel	
			Part #	Price/E
1/4"	5/16"	37 CFM	DCP2143	\$5.35
	3/8"	37 CFM	DCP2144	5.00
3/8"	1/2"	70 CFM	DCP2545	8.60
1/2"	3/4"	150 CFM	DCP1746	11.65
3/4"	1/2"	200 CFM	DCP7145	22.75
	3/4"	200 CFM	DCP7146	22.25
	1"	200 CFM	DCP7148	33.85

Push-On Hose Barb Plugs



Body Size	Hose ID	Flow Rating at 100 PSI	Steel	
			Part #	Price/E
1/4"	3/8"	37 CFM	DCP2144L	\$5.00
3/8"	1/4"	70 CFM	DCP2542L	7.35

Dixon® Keychain

Feature:

- halves separate like a coupler and plug



Plated Steel	
Part #	Price/E
DKC1	\$20.95

Features:

- couplers shut-off when disconnected
- pressure rating: **300 PSI**
- temperature range: **-40°F to 250°F (-40°C to 121°C)**
- interchanges with many other manufacturer's designs
- interchanges with MIL Spec. MIL-C-4109F/A-A-59439
- for air service only 

Semi-Auto Female Couplers

Body Size	Female NPT	Flow Rating at 100 PSI	Brass		Steel	
			Part #	Price/E	Part #	Price/E
1/4"	1/8"	37 CFM	DC2021	\$15.85	---	---
	1/4"	37 CFM	DC20	10.45	---	---
	3/8"	37 CFM	DC2023	14.40	---	---
3/8"	1/4"	70 CFM	---	---	DC2622	\$23.75
	3/8"	70 CFM	---	---	DC26	22.20
	1/2"	70 CFM	---	---	DC2624	29.60
1/2"	3/8"	150 CFM	---	---	DC1023	33.30
	1/2"	150 CFM	---	---	DC10	31.20
	3/4"	150 CFM	---	---	DC1026	41.00



Semi-Auto Male Couplers

Body Size	Male NPT	Flow Rating at 100 PSI	Brass		Steel	
			Part #	Price/E	Part #	Price/E
1/4"	1/8"	37 CFM	DC2101	\$13.45	---	---
	1/4"	37 CFM	DC21	11.20	---	---
	3/8"	37 CFM	DC2103	13.40	---	---
3/8"	1/4"	70 CFM	---	---	DC2502	\$22.95
	3/8"	70 CFM	---	---	DC25	23.10
	1/2"	70 CFM	---	---	DC2504	28.35
1/2"	3/8"	150 CFM	---	---	DC903	31.25
	1/2"	150 CFM	---	---	DC9	27.45
	3/4"	150 CFM	---	---	DC906	36.90



Semi-Auto Standard Hose Barb Couplers

Body Size	Hose ID	Flow Rating at 100 PSI	Brass		Steel	
			Part #	Price/E	Part #	Price/E
1/4"	1/4"	37 CFM	DC2042	\$13.90	---	---
	5/16"	37 CFM	DC2043	14.30	---	---
	3/8"	37 CFM	DC2044	13.70	---	---
3/8"	3/8"	70 CFM	---	---	DC2644	\$24.50
	1/2"	70 CFM	---	---	DC2645	26.05
1/2"	3/8"	150 CFM	---	---	DC1044	35.60
	1/2"	150 CFM	---	---	DC1045	33.45
	3/4"	150 CFM	---	---	DC1046	35.30



Semi-Auto Push-On Hose Barb Couplers

Body Size	Hose ID	Flow Rating at 100 PSI	Brass		Steel	
			Part #	Price/E	Part #	Price/E
1/4"	1/4"	37 CFM	DC2042L	\$13.75	---	---
	3/8"	37 CFM	DC2044L	14.05	---	---
3/8"	1/4"	70 CFM	---	---	DC2642L	\$32.45
	3/8"	70 CFM	---	---	DC2644L	26.30



Features:

- couplers shut-off when disconnected
- pressure rating: **300 PSI**
- temperature range: **-40°F to 250°F (-40°C to 121°C)**
- interchanges with many other manufacturer's designs
- interchanges with MIL Spec. MIL-C-4109F/A-A-59439
- for air service only 

Automatic Female Couplers



Body Size	Female NPT	Flow Rating at 100 PSI	Brass	
			Part #	Price/E
¾"	½"	200 CFM	DC7024	\$68.65
	¾"	200 CFM	DC7026	70.25
	1"	200 CFM	DC7028	76.35

Automatic Male Couplers



Body Size	Male NPT	Flow Rating at 100 PSI	Brass	
			Part #	Price/E
¾"	½"	200 CFM	DC7104	\$72.80
	¾"	200 CFM	DC7106	74.50
	1"	200 CFM	DC7108	82.65

Automatic Couplers Standard Hose Barb Couplers

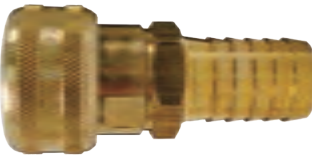

Body Size	Male NPT	Flow Rating at 100 PSI	Brass	
			Part #	Price/E
¾"	½"	200 CFM	DC7045	\$79.95
	¾"	200 CFM	DC7046	80.95
	1"	200 CFM	DC7048	83.65

Parker E-z-mate Industrial Couplings

E-z-mate couplings combine push-to-connect, exhaust-style action with a self-locking valve sleeve to guard against accidental disconnection. Simply follow the direction of the on-off arrow stamped on the yellow chromate valve sleeve. Valve sleeve acts as an integral shut-off valve that allows connection and disconnection at zero pressure. When the sleeve is moved to shut off air flow, it automatically vents downstream allowing for disconnection at zero pressure and eliminating the risk of hose whip.

Features:

- pressure rating: **300 PSI**
- temperature range (standard seals): **-40°F to +250°F (-40°C to 121°C)**
- meets ISO 4414 requirements for a controlled pressure release system
- not recommended for vacuum service



Female Threaded Couplers

Body Size	Female NPT	Flow Rating at 100 PSI	Steel	
			Part #	Price/E
1/4"	1/4"-18	37 CFM	DC20SE	\$55.60
	3/8"-18	37 CFM	DC2023SE	59.95
3/8"	3/8"-18	70 CFM	DC26SE	67.35
	1/2"-14	70 CFM	DC2624SE	73.20
1/2"	1/2"-14	150 CFM	DC10SE	78.55
	3/4"-14	150 CFM	DC1026SE	88.75
3/4"	3/4"-14	200 CFM	DC7026SE	115.30
	1"-11-1/2	200 CFM	DC7028SE	136.70



Male Threaded Couplers

Body Size	Male NPT	Flow Rating at 100 PSI	Steel	
			Part #	Price/E
1/4"	1/4"-18	37 CFM	DC21SE	\$63.75
	3/8"-18	37 CFM	DC2103SE	74.50
3/8"	3/8"-18	70 CFM	DC25SE	81.10
1/2"	1/2"-14	150 CFM	DC9SE	86.20
3/4"	3/4"-14	200 CFM	DC7106SE	154.85



Standard Hose Barb Couplers

Body Size	Hose ID	Flow Rating at 100 PSI	Steel	
			Part #	Price/E
1/4"	1/4"	37 CFM	DC2042SE	\$76.50
	3/8"	37 CFM	DC2044SE	80.10
3/8"	3/8"	70 CFM	DC2644SE	85.70
1/2"	1/2"	150 CFM	DC1045SE	92.10



Push-Lock Hose Barb Couplers

Body Size	Hose ID	Flow Rating at 100 PSI	Steel	
			Part #	Price/E
1/4"	1/4"	37 CFM	DC2042LSE	\$91.80
	3/8"	37 CFM	DC2044LSE	77.55
3/8"	3/8"	70 CFM	DC2644LSE	82.65
1/2"	1/2"	150 CFM	DC1045LSE	92.10



Legris Industrial Interchange Safety Couplers

Applications:

- suited for numerous installations including: pneumatic tools, blow guns, pneumatic automotive equipment

Features:

- temperature range: **-4°F to 140°F (-40°C to 121°C)**
- working pressure: **230 PSI**
- composite, non-marring body
- 1/4" body size ensures excellent flow and total security due to disconnection in two steps
- compatible with industrial interchange plugs



1. vents plug side



2. disconnects

Female Threaded Automatic Couplers



Body Size	NPT Size	Part #	Price/E
1/4"	1/4"	9415U0614	\$43.40
	3/8"	9415U0618	48.50

Male Threaded Automatic Couplers



Body Size	NPT Size	Part #	Price/E
1/4"	1/4"	9405U0614	\$43.35
	3/8"	9405U0618	48.65

Air Chief Automotive Interchange Couplings

Features:

- pressure rating: **300 PSI**
- temperature range: **-40°F to 250°F (-40°C to 121°C)**
- interchange with popular makes of automotive quick-connect fittings such as Amflo, Dill, Milton and Truflate, some designs do not interchange with others, if you plan to interchange these couplings make sure you have plug ends with the proper configuration

Female Plugs

Body Size	Female NPT	Flow Rating at 100 PSI	Steel	
			Part #	Price/E
1/4"	1/8"	37 CFM	DCP221	\$3.50
	1/4"	37 CFM	DCP2	3.50
	3/8"	37 CFM	DCP223	7.05
3/8"	1/4"	70 CFM	DCP8	4.45
	3/8"	70 CFM	DCP6	8.35
	1/2"	70 CFM	DCP624	11.65



Male Plugs

Body Size	Male NPT	Flow Rating at 100 PSI	Steel	
			Part #	Price/E
1/4"	1/8"	37 CFM	DCP101	\$4.40
	1/4"	37 CFM	DCP1	2.70
	3/8"	37 CFM	DCP103	4.90
3/8"	1/4"	70 CFM	DCP7	4.40
	3/8"	70 CFM	DCP5	4.80



Standard Hose Barb Plugs

Body Size	Hose ID	Flow Rating at 100 PSI	Steel	
			Part #	Price/E
1/4"	1/8"	37 CFM	DCP142	\$5.35
	1/4"	37 CFM	DCP144	5.25
3/8"	3/8"	37 CFM	DCP544	6.65



Push-On Hose Barb Plugs

Body Size	Hose ID	Flow Rating at 100 PSI	Steel	
			Part #	Price/E
1/4"	1/4"	37 CFM	DCP142L	\$5.80
	3/8"	37 CFM	DCP144L	5.80
3/8"	3/8"	70 CFM	DCP544L	7.35

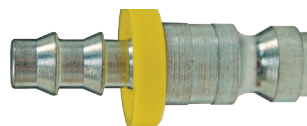

Ball Swivel Plug

Features:

- threaded portion is brass
- plug and nut portion is nickel-plated hardened steel
- pressure rating: **250 PSI**

Body Size	Male NPT	Part #	Price/E
1/4"	1/4"	DCP21SWIV	\$17.70



Features:

- pressure rating: **300 PSI**
- temperature range: **-40°F to 250°F (-40°C to 121°C)**
- interchanges with popular makes of automotive quick-connect fittings such as Amflo, Dill, Milton and Truflate, some makes do not interchange with any others, if you plan to interchange these couplings make sure you have plug ends with the proper configuration

Female Couplers



Body Size	Female NPT	Flow Rating at 100 PSI	Brass		Steel	
			Part #	Price/E	Part #	Price/E
1/4"	1/8"	37 CFM	DC221	\$15.25	---	---
	1/4"	37 CFM	DC2	11.10	---	---
	3/8"	37 CFM	DC223	15.30	---	---
3/8"	1/4"	70 CFM	---	---	DC8	\$23.20
	3/8"	70 CFM	---	---	DC6	22.55
	1/2"	70 CFM	---	---	DC624	31.15

Male Couplers



Body Size	Male NPT	Flow Rating at 100 PSI	Brass		Steel	
			Part #	Price/E	Part #	Price/E
1/4"	1/8"	37 CFM	DC101	\$14.15	---	---
	1/4"	37 CFM	DC1	11.05	---	---
	3/8"	37 CFM	DC103	14.10	---	---
3/8"	1/4"	70 CFM	---	---	DC7	\$23.15
	3/8"	70 CFM	---	---	DC5	22.50
	1/2"	70 CFM	---	---	DC504	27.80

Standard Hose Barb Couplers



Body Size	Hose ID	Flow Rating at 100 PSI	Brass		Steel	
			Part #	Price/E	Part #	Price/E
1/4"	1/4"	37 CFM	DC242	\$15.05	---	---
	3/8"	37 CFM	DC244	15.45	---	---
3/8"	3/8"	70 CFM	---	---	DC644	\$24.50
	1/2"	70 CFM	---	---	DC645	27.30

Push-On Hose Barb Couplers



Body Size	Hose ID	Flow Rating at 100 PSI	Brass		Steel	
			Part #	Price/E	Part #	Price/E
1/4"	1/4"	37 CFM	DC242L	\$14.70	---	---
	3/8"	37 CFM	DC244L	15.45	---	---
3/8"	3/8"	70 CFM	---	---	DC644L	\$26.30

Automotive Ball Swivel Plug



Body Size	Male NPT	Part #	Price/E
1/4"	1/4"	DCP1SWIV	\$17.70

Air Chief Automotive Actual Size Profile Charts

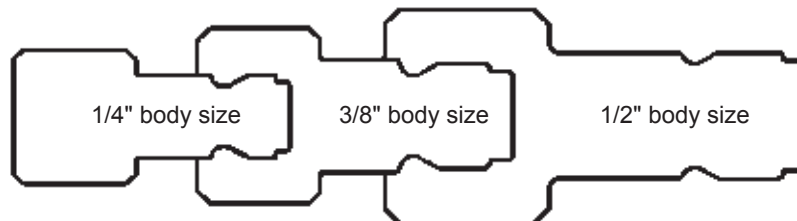

Air Chief ARO Speed Interchange Couplings

Features:

- pressure rating: **300 PSI** at ambient temperature **70°F (21°C)**
- interchanges with ARO 210 and 310 designs
- couplers shut-off when disconnected

Female Plugs

Body Size	Female NPT	Flow Rating at 100 PSI	Steel	
			Part #	Price/E
1/4"	1/4"	37 CFM	DCP38	\$3.15
	3/8"	37 CFM	DCP3823	8.25
3/8"	3/8"	70 CFM	DCP36	9.70



Male Plugs

Body Size	Male NPT	Flow Rating at 100 PSI	Steel	
			Part #	Price/E
1/4"	1/4"	37 CFM	DCP37	\$3.00
	3/8"	37 CFM	DCP3703	6.45
3/8"	3/8"	70 CFM	DCP35	8.70



Standard Hose Barb

Body Size	Hose ID	Flow Rating at 100 PSI	Steel	
			Part #	Price/E
1/4"	1/4"	37 CFM	DCP3742	\$5.35



Push-On Hose Barb

Body Size	Male NPT	Flow Rating at 100 PSI	Steel	
			Part #	Price/E
1/4"	1/4"	37 CFM	DCP3742L	\$6.50
	3/8"	37 CFM	DCP3744L	10.40

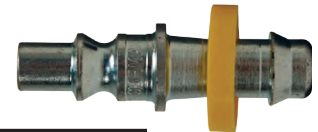

Ball Swivel Plug

Body Size	Male NPT	Part #	Price/E
1/4"	1/4"	DCP37SWIV	\$17.70



Semi-Auto Female Couplers

Body Size	Hose ID	Flow Rating at 100 PSI	Brass		Steel	
			Part #	Price/E	Part #	Price/E
1/4"	1/4"	37 CFM	DC38	\$11.95	---	---
	3/8"	37 CFM	DC3823	15.85	---	---
3/8"	3/8"	70 CFM	---	---	DC36	\$35.35



Semi-Auto Male Couplers

Body Size	Hose ID	Flow Rating at 100 PSI	Brass		Steel	
			Part #	Price/E	Part #	Price/E
1/4"	1/4"	37 CFM	DC37	\$12.90	---	---
	3/8"	37 CFM	DC3703	16.15	---	---
3/8"	3/8"	70 CFM	---	---	DC35	\$32.25

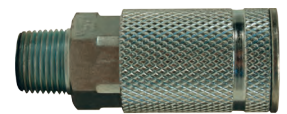

Semi-Auto Standard Hose Barb Couplers

Body Size	Hose ID	Flow Rating at 100 PSI	Steel	
			Part #	Price/E
1/4"	1/4"	37 CFM	DC3842	\$19.60
	3/8"	37 CFM	DC3844	23.30



Semi-Auto Push-On Hose Barb Couplers

Body Size	Hose ID	Flow Rating at 100 PSI	Brass	
			Part #	Price/E
1/4"	1/4"	37 CFM	DC3842L	\$15.30
	3/8"	37 CFM	DC3844L	15.75



Air Chief ARO Actual Size Profile Charts

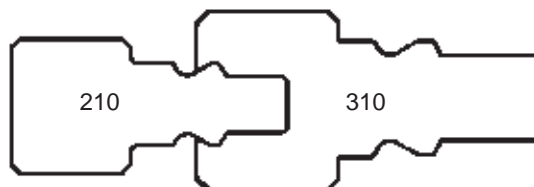

Air Chief Lincoln Interchange Couplings

Features:

- interchangeable with the Lincoln Interchange long stem series
- pressure rating: **300 PSI** at ambient temperature **70°F (21°C)**
- couplers shut-off when disconnected



Female Plug

Body Size	Female NPT	Flow Rating at 100 PSI	Steel	
			Part #	Price/E
1/4"	1/4"	37 CFM	DCP28	\$8.00



Male Plug

Body Size	Male NPT	Flow Rating at 100 PSI	Steel	
			Part #	Price/E
1/4"	1/4"	37 CFM	DCP27	\$6.55



Female Coupler

Body Size	Female NPT	Flow Rating at 100 PSI	Brass	
			Part #	Price/E
1/4"	1/4"	37 CFM	DC28	\$18.65



Male Coupler

Body Size	Female NPT	Flow Rating at 100 PSI	Brass	
			Part #	Price/E
1/4"	1/4"	37 CFM	DC27	\$19.30

Air Chief Lincoln Actual Size Profile Charts

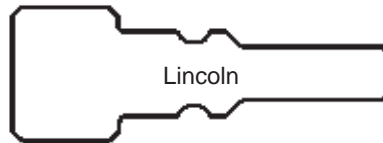

DF-Series Pneumatic Couplings

Features:

- pressure ratings: brass coupler / steel plug: **500 PSI**, brass coupler / brass plug: **300 PSI**, steel coupler / steel plug: **500 PSI**, 303 stainless steel coupler / 303 stainless steel plug: **500 PSI**
- temperature range: **-40°F to 250°F (-40°C to 121°C)**
- interchanges with other Industrial Interchange designs
- interchanges with the MIL-C-4109, A-A 59439, and ISO6150B standards

It is important to be safe when installing quick disconnect couplings into a pneumatic circuit. Never install a pneumatic coupling directly into an air tool, use a piece of hose that is at least 18" long, between the tool and the coupling, to prevent damage to the coupling. To protect the operator, safety devices, such as a safety check valve and safety cable should be installed in case there is a hose or coupling failure. For safety check valves and cables see pages G-46 and I-26.



Female Thread Plugs

Body Size	Threads	Previous Part #	Brass		Steel		303 Stainless Steel		
			Part #	Price/E	Part #	Price/E	Previous Part #	Part #	Price/E
1/4"	1/8" - 27 NPTF	---	---	---	D2F1	\$3.45	---	---	---
	1/4" - 18 NPTF	DCP20B	D2F2-B	\$3.41	D2F2	2.16	DCP20S	D2F2-S	\$11.58
	1/4" - 19 BSPP	---	---	---	D2BF2	3.55	---	---	---
	3/8" - 18 NPTF	DCP2023B	D2F3-B	5.23	D2F3	3.63	---	D2F3-S	12.58
	3/8" - 19 BSPP	---	---	---	D2BF3	4.93	---	---	---
3/8"	1/4" - 18 NPTF	---	---	---	D3F2	4.97	---	---	---
	3/8" - 18 NPTF	---	D3F3-B	6.82	D3F3	4.33	DCP26S	D3F3-S	26.32
	3/8" - 19 BSPP	---	---	---	D3BF3	4.97	---	---	---
	1/2" - 14 NPTF	---	---	---	D3F4	7.89	---	---	---
1/2"	3/8" - 18 NPTF	---	---	---	D4F3	7.60	---	---	---
	1/2" - 14 NPTF	---	D4F4-B	8.87	D4F4	7.31	DCP18S	D4F4-S	28.65
	1/2" - 14 BSPP	---	---	---	D4BF4	7.60	---	---	---
	3/4" - 14 NPTF	---	D4F6-B	14.89	D4F6	12.86	---	---	---
3/4"	1/2" - 14 NPTF	---	---	---	D6F4	15.05	---	---	---
	3/4" - 14 NPTF	---	---	---	D6F6	15.94	---	---	---
	1" - 11 1/2 NPTF	---	---	---	D6F8	25.28	---	---	---



brass



steel



303 stainless



Male Thread Plugs

Body Size	Threads	Previous Part #	Brass		Steel		303 Stainless Steel		
			Part #	Price/E	Part #	Price/E	Previous Part #	Part #	Price/E
1/4"	1/8" - 27 NPTF	DCP2101B	D2M1-B	\$3.64	D2M1	\$2.75	---	D2M1-S	\$12.58
	1/4" - 18 NPTF	DCP21B	D2M2-B	2.39	D2M2	2.10	DCP21S	D2M2-S	9.13
	1/4" - 19 BSPT	---	---	---	D2BM2	2.83	---	---	2.83
	3/8" - 18 NPTF	DCP2103B	D2M3-B	4.54	D2M3	3.16	---	D2M3-S	12.58
	3/8" - 19 BSPT	---	---	---	D2BM3	3.62	---	---	3.62
3/8"	1/4" - 18 NPTF	---	---	---	D3M2	3.56	---	---	3.56
	3/8" - 18 NPTF	---	D3M3-B	5.85	D3M3	3.51	DCP25S	D3M3-S	18.72
	3/8" - 19 BSPT	---	---	---	D3BM3	4.91	---	---	4.91
	1/2" - 14 NPTF	---	---	---	D3M4	7.01	---	---	7.01
1/2"	1/4" - 18 NPTF	---	---	---	D4M2	6.96	---	---	6.96
	3/8" - 18 NPTF	---	---	---	D4M3	5.73	---	---	5.73
	1/2" - 14 NPTF	---	D4M4-B	9.21	D4M4	5.85	DCP17S	D4M4-S	28.65
	1/2" - 14 BSPT	---	---	---	D4BM4	7.54	---	---	7.54
	3/4" - 14 NPTF	---	D4M6-B	13.24	D4M6	10.76	---	---	10.76
3/4"	1/2" - 14 NPTF	---	---	---	D6M4	13.54	---	---	13.54
	3/4" - 14 NPTF	---	---	---	D6M6	13.54	---	---	13.54
	1" - 11 1/2 NPTF	---	---	---	D6M8	15.05	---	---	15.05



brass



steel



303 stainless

Pneumatic Fittings



brass



steel



303 stainless

DF-Series Standard Hose Barb Plugs

Body Size	Hose ID	Brass			Steel			303 Stainless Steel		
		Previous Part #	Part #	Price/E	Previous Part #	Part #	Price/E	Previous Part #	Part #	Price/E
1/4"	1/4"	DCP2142B	D2S2-B	\$3.92	DCP2142	D2S2	\$3.73	DCP2142S	D2S2-S	\$11.93
	5/16"	---	---	---	---	D2S2.5	3.84	---	---	3.84
	3/8"	DCP2144B	D2S3-B	4.62	---	D2S3	4.08	---	D2S3-S	13.15
3/8"	1/4"	---	---	---	DCP2542	D3S2	7.01	---	---	7.01
	3/8"	---	D3S3-B	8.98	DCP2544	D3S3	5.44	DCP2544S	D3S3-S	19.30
	1/2"	---	---	---	---	D3S4	7.60	---	---	7.60
1/2"	3/8"	---	D4S3-B	9.66	DCP1744	D4S3	7.60	---	---	7.60
	1/2"	---	D4S4-B	9.66	DCP1745	D4S4	7.01	DCP1745S	D4S4-S	28.65
	3/4"	---	D4S6-B	14.77	---	D4S6	11.40	---	---	11.40
3/4"	1/2"	---	---	---	---	D6S4	19.86	---	---	19.86
	3/4"	---	---	---	---	D6S6	19.86	---	---	19.86
	1"	---	---	---	---	D6S8	24.07	---	---	24.07

D-Series Automatic Female Thread Couplers

Body Size	Threads	Brass			303 Stainless Steel		
		Previous Part #	Part #	Price/E	Previous Part #	Part #	Price/E
1/4"	1/8" - 27 NPTF	---	2DF1-B	\$15.79	---	---	---
	1/4" - 18 NPTF	DCB20	2DF2-B	13.17	DCS20	2DF2-S	\$69.28
	1/4" - 19 BSPP	---	2DBF2-B	13.17	---	---	---
	3/8" - 18 NPTF	DCB2023	2DF3-B	15.54	---	2DF3-S	82.79
	3/8" - 19 BSPP	---	2DBF3-B	15.54	---	---	---
3/8"	1/4" - 18 NPTF	DCB2622	3DF2-B	26.78	---	---	---
	3/8" - 18 NPTF	DCB26	3DF3-B	25.73	DCS26	3DF3-S	103.50
	3/8" - 19 BSPP	---	3DBF3-B	26.78	---	---	---
	1/2" - 14 NPTF	DCB2624	3DF4-B	28.07	---	---	---
1/2"	3/8" - 18 NPTF	DCB1023	4DF3-B	35.62	---	---	---
	1/2" - 14 NPTF	DCB10	4DF4-B	36.26	DCS10	4DF4-S	139.62
	1/2" - 14 BSPP	---	4DBF4-B	36.26	---	---	---
	3/4" - 14 NPTF	DCB1026	4DF6-B	36.26	---	---	---
3/4"	1/2" - 14 NPTF	---	6DF4-B	56.14	---	---	---
	3/4" - 14 NPTF	---	6DF6-B	56.14	---	---	---
	1" - 11 1/2 NPTF	---	6DF8-B	56.14	---	---	---

F-Series Industrial Manual Female Thread Couplers



brass



steel



303 stainless

Body Size	Threads	Brass		Steel		303 Stainless Steel		
		Part #	Price/E	Part #	Price/E	Previous Part #	Part #	Price/E
1/4"	1/8" - 27 NPTF	2FF1-B	\$11.46	---	---	---	---	---
	1/8" - 28 BSPP	2FBF1-B	11.46	---	---	---	---	---
	1/4" - 18 NPTF	2FF2-B	8.53	2FF2	\$11.91	DC20S	2FF2-S	\$49.12
	1/4" - 19 BSPP	2FBF2-B	11.46	---	---	---	---	---
	3/8" - 18 NPTF	2FF3-B	11.13	---	---	---	2FF3-S	54.38
	3/8" - 19 BSPP	2FBF3-B	11.46	---	---	---	---	---
3/8"	1/4" - 18 NPTF	---	---	3FF2	23.39	---	---	---
	3/8" - 18 NPTF	---	---	3FF3	18.13	DC26S	3FF3-S	85.38
	3/8" - 19 BSPP	---	---	3FBF3	23.39	---	---	---
	1/2" - 14 NPTF	---	---	3FF4	27.48	---	---	---
1/2"	3/8" - 18 NPTF	---	---	4FF3	30.99	---	---	---
	1/2" - 14 NPTF	---	---	4FF4	22.93	DC10S	4FF4-S	107.59
	1/2" - 14 BSPP	---	---	4FBF4	30.99	---	---	---
	3/4" - 14 NPTF	---	---	4FF6	31.58	---	---	---

D-Series Automatic Male Thread Couplers

Body Size	Threads	Previous Part #	Brass		303 Stainless Steel		
			Part #	Price/E	Previous Part #	Part #	Price/E
1/4"	1/8" - 27 NPTF	---	2DM1-B	\$15.79	---	---	---
	1/4" - 18 NPTF	DCB21	2DM2-B	13.17	DCS21	2DM2-S	\$62.58
	1/4" - 19 BSPT	---	2DBM2-B	13.17	---	---	---
	3/8" - 18 NPTF	DCB2103	2DM3-B	15.54	---	2DM3-S	81.32
	3/8" - 19 BSPT	---	2DBM3-B	15.54	---	---	---
3/8"	1/4" - 18 NPTF	DCB2502	3DM2-B	26.78	---	---	---
	3/8" - 18 NPTF	DCB25	3DM3-B	25.73	DCS25	3DM3-S	100.44
	3/8" - 19 BSPT	---	3DBM3-B	26.03	---	---	---
	1/2" - 14 NPTF	DCB2504	3DM4-B	27.21	---	---	---
1/2"	3/8" - 18 NPTF	DCB903	4DM3-B	33.99	---	---	---
	1/2" - 14 NPTF	DCB9	4DM4-B	33.06	DCS9	4DM4-S	132.09
	1/2" - 14 BSPT	---	4DBM4-B	33.99	---	---	---
	3/4" - 14 NPTF	DCB906	4DM6-B	34.89	---	---	---
3/4"	1/2" - 14 NPTF	---	6DM4-B	56.14	---	---	---
	3/4" - 14 NPTF	---	6DM6-B	56.14	---	---	---
	1" - 11 1/2 NPTF	---	6DM8-B	56.14	---	---	---



brass



303 stainless

Pneumatic Fittings

F-Series Manual Male Thread Couplers

Body Size	Threads	Brass		Steel		303 Stainless Steel		
		Part #	Price/E	Part #	Price/E	Previous Part #	Part #	Price/E
1/4"	1/8" - 27 NPTF	2FM1-B	\$11.25	---	---	---	2FM1-S	\$54.97
	1/8" - 28 BSPT	2FBM1-B	12.28	---	---	---	---	---
	1/4" - 18 NPTF	2FM2-B	8.53	2FM2	\$11.91	DC21S	2FM2-S	45.61
	1/4" - 19 BSPT	2FBM2-B	12.28	---	---	---	---	---
	3/8" - 18 NPTF	2FM3-B	11.25	---	---	---	2FM3-S	54.97
3/8"	3/8" - 19 BSPT	2FBM3-B	12.28	---	---	---	---	---
	1/4" - 18 NPTF	---	---	3FM2	21.99	---	---	---
	3/8" - 18 NPTF	---	---	3FM3	18.94	DC25S	3FM3-S	81.86
	3/8" - 19 BSPT	---	---	3FBM3	21.99	---	---	---
1/2"	1/2" - 14 NPTF	---	---	3FM4	24.33	---	---	---
	3/8" - 18 NPTF	---	---	4FM3	29.94	---	---	---
	1/2" - 14 NPTF	---	---	4FM4	21.75	DC9S	4FM4-S	111.45
	1/2" - 14 BSPT	---	---	4FBM4	29.94	---	---	---
3/4"	3/4" - 14 NPTF	---	---	4FM6	31.46	---	---	---



brass



steel



303 stainless



D-Series Automatic Standard Hose Barb Couplers



brass



303 stainless

Body Size	Hose ID	Previous Part #	Brass		303 Stainless Steel		
			Part #	Price/E	Previous Part #	Part #	Price/E
1/4"	1/4"	DCB2042	2DS2-B	\$13.45	DCS2042	2DS2-S	\$75.83
	3/8"	DCB2044	2DS3-B	15.55	---	2DS3-S	81.84
3/8"	1/4"	DCB2642	3DS2-B	28.07	---	---	---
	3/8"	DCB2644	3DS3-B	24.56	DCS2644	3DS3-S	101.10
	1/2"	DCB2645	3DS4-B	29.24	---	---	---
1/2"	3/8"	DCB1044	4DS3-B	35.62	---	---	---
	1/2"	DCB1045	4DS4-B	36.11	DCS1045	4DS4-S	119.13
	3/4"	DCB1046	4DS6-B	36.44	---	---	---
3/4"	1/2"	---	6DS4-B	59.56	---	---	---
	3/4"	---	6DS6-B	60.20	---	---	---
	1"	---	6DS8-B	60.35	---	---	---

F-Series Manual Standard Hose Barb Couplers



brass



steel



303 stainless

Body Size	Hose ID	Brass		Previous Part #	Steel		303 Stainless Steel		
		Part #	Price/E		Part #	Price/E	Previous Part #	Part #	Price/E
1/4"	1/4"	2FS2-B	\$11.25	---	2FS2	\$11.91	DC2042S	2FS2-S	\$56.14
	5/16"	2FS2.5-B	11.58	---	---	---	---	---	---
	3/8"	2FS3-B	11.36	---	---	---	---	2FS3-S	65.50
3/8"	1/4"	---	---	DC2642	3FS2	26.24	---	---	---
	3/8"	---	---	---	3FS3	21.34	DC2644S	3FS3-S	86.54
	1/2"	---	---	---	3FS4	25.90	---	---	---
1/2"	3/8"	---	---	---	4FS3	29.71	---	---	---
	1/2"	---	---	---	4FS4	27.48	DC1045S	4FS4-S	111.45
	3/4"	---	---	---	4FS6	30.53	---	---	---

D-Series Automatic Push-Loc Barb Couplers

Body Size	Hose ID	Brass	
		Part #	Price/E
1/4"	1/4"	2DB2-B	\$14.27
	3/8"	2DB3-B	16.38
3/8"	3/8"	3DB3-B	29.82
	1/2"	4DB4-B	35.08



F-Series Manual Push-Loc Barb Couplers

Body Size	Hose ID	Brass		Steel	
		Part #	Price/E	Part #	Price/E
1/4"	1/4"	2FB2-B	\$11.25	---	---
	3/8"	2FB3-B	11.36	---	---
3/8"	1/4"	---	---	3FB2	\$26.24
	3/8"	---	---	3FB3	26.01
	1/2"	---	---	3FB4	26.62
1/2"	3/8"	---	---	4FB3	32.74
	1/2"	---	---	4FB4	31.87



brass

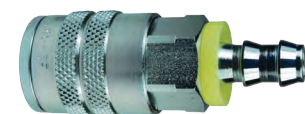

steel

DF-Series Push-Loc Hose Barb Plugs

Body Size	Hose ID	Brass		Previous Part #	Steel	
		Part #	Price/E		Part #	Price/E
1/4"	1/4"	D2B2-B	\$2.21	DCP2142L	D2B2	\$3.73
	3/8"	---	---	---	D2B3	4.08
3/8"	1/4"	---	---	---	D3B2	7.60
	3/8"	---	---	DCP2544L	D3B3	7.41
	1/2"	---	---	---	D3B4	7.95
1/2"	1/2"	---	---	---	D4B4	10.99
3/4"	3/4"	---	---	---	D6B6	23.39



brass



steel

DF-Series Automatic Reusable Barb Couplers

Body Size	Hose ID X OD	Brass	
		Part #	Price/E
1/4"	1/4" x 1/2"	2DE2-B	\$20.35
	1/4" x 5/8"	2DH2-B	20.35
	3/8" x 11/16"	2DK3-B	22.68
	3/8" x 3/4"	2DL3-B	20.35



DF-Series Reusable Barb Plugs

Body Size	Hose ID X OD	Steel	
		Part #	Price/E
1/4"	1/4" x 1/2"	D2E2	\$8.43
	1/4" x 5/8"	D2H2	8.43
	3/8" x 11/16"	D2K3	10.51
	3/8" x 3/4"	D2L3	10.93



Air Chief Industrial Actual Size Profile Charts

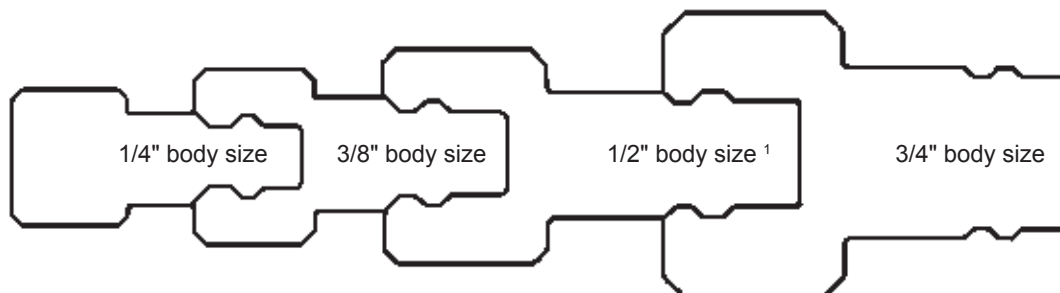

¹ 1/2" may also interchange with 1/2" Automotive Series

J-Series Automotive Pneumatic Couplings

Features:

- pressure rating: Brass Coupler/Steel Plug and Steel Coupler/Steel Plug: **500 PSI**, Brass Coupler/Brass Plug: **300 PSI**
- temperature range: **-40°F to 250°F (-40°C to 121°C)**
- interchanges with other Truflate Automotive designs

Operating pressure for couplings utilizing hose barb end connections may be dramatically reduced to that of the hose rating and/or hose end connection combination. Consult hose manufacturer's catalog for hose end connection ratings. If in doubt, test under controlled conditions for suitability to application. Dixon® cannot assume liability for misapplication of production resulting in equipment down-time, lost production, and/or personal injury including death. 

Female Thread Plugs

brass



steel

Body Size	Threads	Brass		Steel	
		Part #	Price/E	Part #	Price/E
1/4"	1/8" - 27 NPTF	---	---	J2F1	\$3.45
	1/4" - 18 NPTF	J2F2-B	\$3.41	J2F2	2.16
	3/8" - 18 NPTF	---	---	J2F3	3.63
3/8"	1/4" - 18 NPTF	---	---	J3F2	4.97
	3/8" - 18 NPTF	---	---	J3F3	4.33
	1/2" - 14 NPTF	---	---	J3F4	7.89
1/2"	3/8" - 18 NPTF	---	---	J4F3	7.60
	1/2" - 14 NPTF	---	---	J4F4	7.31
	3/4" - 14 NPTF	---	---	J4F6	12.86

Male Thread Plugs

brass



steel

Body Size	Threads	Brass		Steel	
		Part #	Price/E	Part #	Price/E
1/4"	1/8" - 27 NPTF	---	---	J2M1	\$2.75
	1/4" - 18 NPTF	J2M2-B	\$2.39	J2M2	2.10
	3/8" - 18 NPTF	---	---	J2M3	3.16
3/8"	1/4" - 18 NPTF	---	---	J3M2	3.56
	3/8" - 18 NPTF	---	---	J3M3	3.51
	1/2" - 14 NPTF	---	---	J3M4	7.01
1/2"	3/8" - 18 NPTF	---	---	J4M3	5.73
	1/2" - 14 NPTF	---	---	J4M4	5.85
	3/4" - 14 NPTF	---	---	J4M6	10.76

Standard Hose Barb Plugs

Body Size	Hose ID	Previous Part #	Steel	
			Part #	Price/E
1/4"	1/4"	---	J2S2	\$3.73
	3/8"	---	J2S3	4.08
3/8"	1/4"	DCP542	J3S2	7.01
	3/8"	---	J3S3	5.44
	1/2"	---	J3S4	7.60
1/2"	3/8"	---	J4S3	7.60
	1/2"	---	J4S4	7.01
	3/4"	---	J4S6	11.40

Female Thread Couplers

Body Size	Threads	Brass		Steel	
		Part #	Price/E	Part #	Price/E
1/4"	1/8" - 27 NPTF	2JF1-B	\$11.13	---	---
	1/4" - 18 NPTF	2JF2-B	8.53	---	---
	3/8" - 18 NPTF	2JF3-B	11.13	---	---
3/8"	1/4" - 18 NPTF	---	---	3JF2	\$23.39
	3/8" - 18 NPTF	---	---	3JF3	18.13
	1/2" - 14 NPTF	---	---	3JF4	27.48



brass



steel

- 1/2" body J-Series plugs are used with 1/2" body DF-Series Manual couplers on page G-28

Male Thread Couplers

Body Size	Threads	Brass		Steel	
		Part #	Price/E	Part #	Price/E
1/4"	1/8" - 27 NPTF	2JM1-B	\$11.25	---	---
	1/4" - 18 NPTF	2JM2-B	8.53	---	---
	3/8" - 18 NPTF	2JM3-B	11.25	---	---
3/8"	1/4" - 18 NPTF	---	---	3JM2	\$21.99
	3/8" - 18 NPTF	---	---	3JM3	18.94
	1/2" - 14 NPTF	---	---	3JM4	24.33



brass

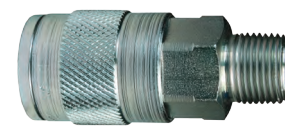

steel

- 1/2" body J-Series plugs are used with 1/2" body DF-Series Manual couplers on page G-29

Standard Hose Barb Couplers

Body Size	Hose ID	Brass		Steel	
		Part #	Price/E	Part #	Price/E
1/4"	1/4"	2JS2-B	\$11.25	---	---
	3/8"	2JS3-B	11.36	---	---
3/8"	1/4"	---	---	3JS2	\$26.24
	3/8"	---	---	3JS3	21.34
	1/2"	---	---	3JS4	25.90



brass



steel

- 1/2" body J-Series plugs are used with 1/2" body DF-Series Manual couplers on page G-30

Push-Loc Hose Barb Couplers

Body Size	Hose ID	Brass		Steel	
		Part #	Price/E	Part #	Price/E
1/4"	1/4"	2JB2-B	\$11.25	---	---
	3/8"	2JB3-B	11.36	---	---
3/8"	1/4"	---	---	3JB2	\$26.24
	3/8"	---	---	3JB3	26.01
	1/2"	---	---	3JB4	26.62

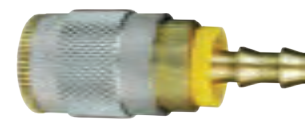

brass



steel

- 1/2" body J-Series plugs are used with 1/2" body DF-Series Manual couplers on page G-31

Push-Loc Hose Barb Plugs

Body Size	Hose ID	Steel	
		Part #	Price/E
1/4"	1/4"	J2B2	\$3.73
	3/8"	J2B3	4.08
3/8"	3/8"	J3B3	7.41
	1/2"	J4B4	10.99



M-Series ARO Pneumatic Couplings

Features:

- pressure rating: **300 PSI** at ambient temperature **70°F (21°C)**
- automatic couplings interchanges with ARO 210/310 designs and Hansen Series 210/310
- manual couplings interchange with Parker 50-Series and Amflo Type 'B'

It is important to be safe when installing quick disconnect couplings into a pneumatic circuit. Never install a pneumatic coupling directly into an air tool, use a piece of hose that is at least 18" long, between the tool and the coupling, to prevent damage to the coupling. To protect the operator, safety devices, such as a safety check valve and safety cable should be installed in case there is a hose or coupling failure. For safety check valves and cables see pages G-46 and I-26. 

Female Thread Plugs



brass



steel

Body Size	Threads	Brass		Steel	
		Part #	Price/E	Part #	Price/E
1/4"	1/4" - 18 NPTF	M2F2-B	\$2.34	M2F2	\$2.22
	3/8" - 18 NPTF	---	---	M2F3	5.29
3/8"	3/8" - 18 NPTF	---	---	M3F3	6.38

Male Thread Plugs



brass



steel

Body Size	Threads	Brass		Steel	
		Part #	Price/E	Part #	Price/E
1/4"	1/8" - 27 NPTF	---	---	M2M1	\$3.31
	1/4" - 18 NPTF	M2M2-B	\$2.22	M2M2	2.16
	3/8" - 18 NPTF	---	---	M2M3	4.51
3/8"	3/8" - 18 NPTF	---	---	M3M3	6.02

Standard Hose Barb Plugs



Body Size	Hose ID	Previous Part #	Steel	
			Part #	Price/E
1/4"	1/4"	---	M2S2	\$4.20
	3/8"	DCP3744	M2S3	5.06
3/8"	3/8"	---	M3S3	7.34

Automatic Female Thread Couplers



Body Size	Threads	Steel / Brass	
		Part #	Price/E
1/4"	1/4" - 18 NPT	2MF2-PL	\$13.24
	3/8" - 18 NPT	2MF3-PL	15.94
3/8"	3/8" - 18 NPT	3MF3-PL	20.16

Manual Female Thread Couplers



Body Size	Threads	Brass	
		Part #	Price/E
1/4"	1/4" - 18 NPT	2MF2-B	\$11.05
	3/8" - 18 NPT	2MF3-B	13.10

Automatic Male Thread Couplers

Body Size	Threads	Steel / Brass	
		Part #	Price/E
1/4"	1/4" - 18 NPT	2MM2-PL	\$13.24
	3/8" - 18 NPT	2MM3-PL	15.94
3/8"	3/8" - 18 NPT	3MM3-PL	20.16
	1/2" - 14 NPTF	3MM4-PL	18.82



Manual Male Thread Couplers

Body Size	Threads	Brass	
		Part #	Price/E
1/4"	1/4" - 18 NPT	2MM2-B	\$11.05
	3/8" - 18 NPT	2MM3-B	13.10



Automatic Standard Hose Barb Couplers

Body Size	Hose ID	Steel / Brass	
		Part #	Price/E
1/4"	1/4"	2MS2-PL	\$15.33
	5/16"	2MS2.5-PL	15.33
	3/8"	2MS3-PL	16.48
3/8"	3/8"	3MS3-PL	18.18



Manual Standard Hose Barb Couplers

Body Size	Hose ID	Brass	
		Part #	Price/E
1/4"	1/4"	2MS2-B	\$13.28
	3/8"	2MS3-B	14.04



Push-Loc Barb Plug

Body Size	Hose ID	Steel	
		Part #	Price/E
1/4"	1/4"	M2B2	\$3.37



- see push-lok couplers in Air Chief on page G-31

CJ-Series Pneumatic Couplings

Features:

- European High-Flow Interchange
- pressure rating: **300 PSI**
- temperature range: **-40°F to 250°F (-40°C to 112°C)**
- interchanges with Cejn 320/410, Coilhouse Megaflo, Rectus 25 KA/26KA/27KA and other like designs



Female Thread Couplers

Body Size	Threads	Previous Part #	Brass	
			Part #	Price/E
1/4"	1/4" - 18 NPT	DC41	2CJF2-B	\$16.80
	1/4" - 19 BSPP	---	2CJBF2-B	16.80
	3/8" - 18 NPT	---	2CJF3-B	24.14
	3/8" - 19 BSPP	---	2CJBF3-B	24.14
3/8"	3/8" - 18 NPT	---	3CJF3-B	34.32
	3/8" - 19 BSPP	---	3CJBF3-B	34.32
	1/2" - 14 NPT	---	3CJF4-B	36.75
	1/2" - 14 BSPP	---	3CJBF4-B	36.75

Female Thread Plugs



brass



steel

Body Size	Threads	Brass		Steel	
		Part #	Price/E	Part #	Price/E
1/4"	1/4" - 18 NPT	CJ2F2-B	\$3.79	CJ2F2-LG	\$4.83
	1/4" - 19 BSPP	CJ2BF2-B	3.79	CJ2BF2-LG	4.83
	3/8" - 18 NPT	CJ2F3-B	4.78	CJ2F3-LG	6.30
	3/8" - 19 BSPP	CJ2BF3-B	4.78	CJ2BF3-LG	6.30
3/8"	3/8" - 18 NPT	CJ3F3-B	4.46	CJ3F3	6.33
	3/8" - 19 BSPP	CJ3BF3-B	4.46	CJ3BF3	6.33
	1/2" - 14 NPT	CJ3F4-B	4.97	CJ3F4	7.64
	1/2" - 14 BSPP	CJ3BF4-B	4.97	CJ3BF4	7.64

Male Thread Couplers



Body Size	Threads	Brass	
		Part #	Price/E
1/4"	1/4" - 18 NPT	2CJM2-B	\$16.35
	1/4" - 19 BSPT	2CJBM2-B	16.35
	3/8" - 18 NPT	2CJM3-B	17.42
	3/8" - 19 BSPT	2CJBM3-B	17.42
3/8"	3/8" - 18 NPT	3CJM3-B	34.32
	3/8" - 19 BSPT	3CJBM3-B	34.32
	1/2" - 14 NPT	3CJM4-B	36.75
	1/2" - 14 BSPT	3CJBM4-B	36.75

Male Thread Plugs



brass



steel

Body Size	Threads	Previous Part #	Brass		Steel	
			Part #	Price/E	Part #	Price/E
1/4"	1/4" - 18 NPT	DCP41	CJ2M2-B	\$3.58	CJ2M2-LG	\$4.59
	1/4" - 19 BSPT	---	CJ2BM2-B	3.58	CJ2BM2-LG	4.59
	3/8" - 18 NPT	---	CJ2M3-B	4.71	CJ2M3-LG	6.03
	3/8" - 19 BSPT	---	CJ2BM3-B	4.71	CJ2BM3-LG	6.03
3/8"	3/8" - 18 NPT	---	CJ3M3-B	4.26	CJ3M3	5.94
	3/8" - 19 BSPT	---	CJ3BM3-B	5.76	CJ3BM3	5.94
	1/2" - 14 NPT	---	CJ3M4-B	4.63	CJ3M4	7.64
	1/2" - 14 BSPT	---	CJ3BM4-B	4.63	CJ3BM4	7.64

SHD- Series Schrader Pneumatic Couplings

Features:

- pressure rating: **300 PSI**
- temperature range: **-40°F to 250°F (-40°C to 112°C)**
- interchanges with Parker Twist-Lock, Tomco Series-TL, Foster SHD

Operating pressure for couplings utilizing hose barb end connections may be dramatically reduced to that of the hose rating and/or hose end connection combination. Consult hose manufacturer's catalog for hose end connection ratings. If in doubt, test under controlled conditions for suitability to application. Dixon Quick Coupling cannot assume liability for misapplication of production resulting in equipment down-time, lost production, and/or personal injury including death. 

Female Thread Couplers

Body Size	Threads	Aluminum	
		Part #	Price/E
1/4"	1/4" - 18 NPT	2SHDF2	\$18.55
	3/8" - 18 NPT	2SHDF3	20.35
1/2"	3/8" - 18 NPT	4SHDF3	33.68
	1/2" - 14 NPT	4SHDF4	33.68
	3/4" - 14 NPT	4SHDF6	34.80



Female Thread Plugs

Body Size	Threads	Steel	
		Part #	Price/E
1/4"	1/8" - 27 NPT	SHD2F1	\$3.62
	1/4" - 18 NPT	SHD2F2	3.62
1/2"	3/8" - 18 NPT	SHD4F3	7.40



Male Thread Couplers

Body Size	Threads	Aluminum	
		Part #	Price/E
1/4"	1/4" - 18 NPT	2SHDM2	\$18.55
	3/8" - 18 NPT	2SHDM3	20.35
1/2"	3/8" - 18 NPT	4SHDM3	33.68
	1/2" - 14 NPT	4SHDM4	33.68



Male Thread Plugs

Body Size	Threads	Steel	
		Part #	Price/E
1/4"	1/8" - 27 NPT	SHD2M1	\$3.58
	1/4" - 18 NPT	SHD2M2	3.58
1/2"	3/8" - 18 NPT	SHD4M3	7.18
	1/2" - 14 NPT	SHD4M4	7.40



Standard Hose Barb Couplers



Body Size	Hose ID	Aluminum	
		Part #	Price/E
1/4"	1/4"	2SHDS2	\$20.18
	3/8"	2SHDS3	21.97
1/2"	3/8"	4SHDS3	35.03
	1/2"	4SHDS4	35.40

Twist-Lock Interchange Standard Hose Barb Plugs



Body Size	Hose ID	Steel	
		Part #	Price/E
1/4"	1/4"	SHD2S2	\$3.58
	3/8"	SHD2S3	4.76
1/2"	3/8"	SHD4S3	8.18
	1/2"	SHD4S4	8.55

L-Series Lincoln Pneumatic Couplings

Features:

- pressure rating: **300 PSI**
- temperature range: **-40°F to 250°F (-40°C to 112°C)**
- Lincoln Long-Nose Automotive Interchange
- interchanges with Parker 70-Series, Tomco Series-1110, Coilhose Type-17

It is important to be safe when installing quick disconnect couplings into a pneumatic circuit. Never install a pneumatic coupling directly into an air tool, use a piece of hose that is at least 18" long, between the tool and the coupling, to prevent damage to the coupling. To protect the operator, safety devices, such as a safety check valve and safety cable should be installed in case there is a hose or coupling failure. For safety check valves and cables see pages G-46 and I-26. 

Female Thread Coupler



Body Size	Threads	Brass	
		Part #	Price/E
1/4"	1/4" - 18 NPT	2LF2-B	\$14.19

Female Thread Plug



Body Size	Threads	Steel	
		Part #	Price/E
1/4"	1/4" - 18 NPT	L2F2	\$4.83

Male Thread Coupler



Body Size	Threads	Brass	
		Part #	Price/E
1/4"	1/4" - 18 NPT	2LM2-B	\$14.19

Male Thread Plug



Body Size	Threads	Steel	
		Part #	Price/E
1/4"	1/4" - 18 NPT	L2M2	\$4.83

U-Series Universal Pneumatic Couplings

Features:

- temperature range: **-40°F to 250°F (-40°C to 112°C)**
- 2U-Series 6-in-1 (Aro 210, Industrial, Truflate, Lincoln, Italian, and CEJN 320)
- 3U-Series 4-in-1 (ARO 310, Industrial, Truflate, and CEJN 410)
- Parker UC-Series, Hansen Auto-Flo 23, and Tomco Series UC
- Each coupler only accepts three pneumatic nipple styles. Although the universal coupler permits multiple series nipples to mate with one coupler, it is recommended to match like series couplers and nipples. When using a Universal coupler, the lower performance rating between the coupler and nipple must take precedence.
- Some pneumatic applications require the pressurized air to be 'dried' to ensure proper operation of equipment and/or application of product (ie. auto body shops). It is best to match like series couplers and nipples in these applications. If it is necessary to use a Universal coupler, lube the seal and valve area regularly to ensure reliable service.
- for air service only 

Female Couplers

Body Size	Threads	Brass	
		Part #	Price/E
1/4"	1/4" - 18 NPT	2UF2-B	\$18.11
	3/8" - 18 NPT	2UF3-B	18.76
3/8"	3/8" - 18 NPT	3UF3-B	35.25



Male Couplers

Body Size	Threads	Brass	
		Part #	Price/E
1/4"	1/4" - 18 NPT	2UM2-B	\$18.11
	3/8" - 18 NPT	2UM3-B	19.84
3/8"	3/8" - 18 NPT	3UM3-B	35.25



Standard Hose Barb Couplers

Body Size	Hose ID	Brass	
		Part #	Price/E
1/4"	1/4"	2US2-B	\$19.23
	3/8"	2US3-B	19.84
3/8"	3/8"	3US3-B	35.55



Push-On Hose Barb Couplers

Body Size	Hose ID	Brass	
		Part #	Price/E
1/4"	1/4"	2UB2-B	\$20.02
	3/8"	2UB3-B	20.02



NK-Series Japanese Pneumatic Couplings

Features:

- Japanese Industrial Interchange Pneumatic Coupling
- Interchanges with Nitto Kohki Hi-Cupla 200, Rectus Series 13, and CEJN Series 315
- Nitrile (Buna-N) seals are standard temperature range **-40°F to 250°F (-40°C to 121°C)**

Female Couplers



Body Size	Threads	Steel	
		Part #	Price/E
1/4"	1/4" - 18 NPT	2NKF2	\$19.60
	1/4" -19 BSPP	2NKBF2	19.60

Female Plugs



Body Size	Threads	Steel	
		Part #	Price/E
1/4"	1/4" - 18 NPT	NK2F2	\$4.04
	1/4" -19 BSPP	NK2BF2	4.04

Male Couplers



Body Size	Threads	Steel	
		Part #	Price/E
1/4"	1/4" - 18 NPT	2NKM2	\$19.60
	1/4" -19 BSPP	2NKBM2	19.60

Male Plugs



Body Size	Threads	Steel	
		Part #	Price/E
1/4"	1/4" - 18 NPT	NK2M2	\$4.04
	1/4" -19 BSPP	NK2BM2	4.04

Hose Barb Coupler



Body Size	Hose ID	Steel	
		Part #	Price/E
1/4"	1/4"	2NKS2	\$19.57

Hose Barb Plug



Body Size	Hose ID	Steel	
		Part #	Price/E
1/4"	1/4"	NK2S2	\$4.04

BR-Series Pneumatic Couplings

Features:

- Interchange data: Rectus 21KA, Tomco Series SC, CEJN Series 223
- Nitrile (Buna-N) seals are standard temperature range **-40°F to 250°F (-40°C to 121°C)**

Female Couplers

Body Size	Threads	Brass	
		Part #	Price/E
1/8"	1/8" - 27 NPT	1BRF1-B-7	\$12.71
	1/8" - 28 BSPP	1BRBF1-B-7	12.71
	1/4" - 18 NPT	1BRF2-B-7	12.71
	1/4" - 19 BSPP	1BRBF2-B-7	12.71

**Female Plugs**

Body Size	Threads	Brass	
		Part #	Price/E
1/8"	1/8" - 27 NPT	BR1F1-B-E-7	\$3.62
	1/8" - 28 BSPP	BR1BF1-B-E-7	3.62
	1/4" - 18 NPT	BR1F2-B-E-7	3.62
	1/4" - 19 BSPP	BR1BF2-B-E-7	3.62

**Male Couplers**

Body Size	Threads	Brass	
		Part #	Price/E
1/8"	1/8" - 27 NPT	1BRM1-B-7	\$12.71
	1/8" - 28 BSPP	1BRGM1-B-7	12.71
	1/4" - 18 NPT	1BRM2-B-7	12.71
	1/4" - 19 BSPP	1BRGM2-B-7	12.71

**Male Plugs**

Body Size	Threads	Brass	
		Part #	Price/E
1/8"	1/8" - 27 NPT	BR1M1-B-E-7	\$3.62
	1/8" - 28 BSPP	BR1GM1-B-E-7	3.62
	1/4" - 18 NPT	BR1M2-B-E-7	3.62
	1/4" - 19 BSPP	BR1GM2-B-E-7	3.62



Hose Barbs Couplers



Body Size	Hose ID	Brass	
		Part #	Price/E
1/8"	4mm	1BRS1.25-B-7	\$12.71
	6mm	1BRS1.86-B-7	12.71
	9mm	1BRS2.83-B-7	12.71

Hose Barbs Plugs



Body Size	Hose ID	Brass	
		Part #	Price/E
1/8"	4mm	BR1S1.25-B-E-7	\$3.62
	6mm	BR1S1.86-B-E-7	3.62
	9mm	BR1S2.83-B-E-7	3.62

A-Series Pneumatic Couplings

Features:

- Interchange data: Dixon Quick Coupling Proprietary Astronautics
- Nitrile (Buna-N) seals are standard temperature range **-40°F to 250°F (-40°C to 121°C)**

Female Couplers



Body Size	Threads	Brass	
		Part #	Price/E
1/8"	1/8" - 27 NPTF	1AF1-B	\$26.50
1/4"	1/8" - 27 NPTF	2AF1-B	27.71
	1/4" - 18 NPTF	2AF2-B	27.71

Female Plugs



brass



steel

Body Size	Threads	Brass		Steel	
		Part #	Price/E	Part #	Price/E
1/8"	1/8" - 27 NPTF	A1F1-B	\$8.13	---	---
1/4"	1/8" - 27 NPTF	A2F1-B	8.13	---	---
	1/4" - 18 NPTF	A2F2-B	8.13	A2F2	\$6.20

Male Couplers



Body Size	Threads	Brass	
		Part #	Price/E
1/8"	1/8" - 27 NPTF	1AM1-B	\$26.50
1/4"	1/8" - 27 NPTF	2AM1-B	27.71
	1/4" - 18 NPTF	2AM2-B	27.71

Male Plugs

Body Size	Threads	Brass		Steel	
		Part #	Price/E	Part #	Price/E
1/8"	1/8" - 27 NPTF	A1M1-B	\$8.13	---	---
1/4"	1/4" - 18 NPTF	A2M2-B	8.13	A2M2	\$5.84



brass



steel

Hose Barb Couplers

Body Size	Hose ID	Brass	
		Part #	Price/E
1/8"	1/8"	1AS1-B	\$28.91
1/4"	1/4"	2AS2-B	30.11



Hose Barb Plugs

Body Size	Hose ID	Brass		Steel	
		Part #	Price/E	Part #	Price/E
1/8"	1/8"	A1S1-B	\$8.13	---	---
1/4"	1/4"	---	---	A2S2	\$10.95



brass



steel

Reusable Barb Coupler

Body Size	Hose ID x OD	Brass	
		Part #	Price/E
1/4"	1/4" x 1/2"	2AE2-B	\$35.15



Reusable Barb Plugs

Body Size	Hose ID	Brass		Steel	
		Part #	Price/E	Part #	Price/E
1/4"	1/4" x 1/2"	A2E2-B	12.17	A2E2	\$12.52



brass



steel

3500 Male Nipples

Features:

- working pressure: **600 PSI** at ambient temperature **70°F (21°C)**
- *for air and water service only*
- The constant vibration created by air tools, like air drills and pavement breakers, is destructive to air hose couplings, especially the quick-acting type. To provide protection against coupling breakage and related hazards, Dixon® recommends the use of a whip hose. To construct a whip hose, connect one end of a short (3' to 10') air hose to the air tool using a 3500 type steel nipple. Connect the other end of the hose to the air supply using the standard quick-acting coupling. The heat-treated 3500 nipple will withstand vibration far better than the standard coupling and provide a safer connection. The whip hose should remain permanently connected to the tool.



Male Threaded

Hose Size	Male NPT	Zinc Plated Steel		Optional Qty
		Part #	Price/E	
1/4"	1/8"	3501	\$6.80	100
1/4"	1/4"	3502	5.50	100
1/4"	3/8"	3504	7.20	100
3/8"	1/4"	3505	6.85	100
3/8"	3/8"	3506	6.90	100
3/8"	1/2"	3508	9.90	100
1/2"	1/4"	3509	7.80	100
1/2"	3/8"	3510	7.30	100
1/2"	1/2"	3512	9.00	100
1/2"	3/4"	3511	15.15	50
3/4"	1/2"	3513	12.75	50
3/4"	3/4"	3514	11.60	50
3/4"	1"	3515	24.70	25
1"	3/4"	3516	20.45	25
1"	1"	3518	17.40	25



Female Threaded

Hose Size	Female NPT	Zinc Plated Steel		Optional Qty
		Part #	Price/E	
1/4"	1/4"	3542	\$12.35	100
3/8"	1/4"	3545	12.95	50
3/8"	3/8"	3546	13.00	50
1/2"	3/8"	3550	12.50	100
1/2"	1/2"	3552	14.65	50
3/4"	3/4"	3554	20.40	50



Male Threaded with Ferrule

Features:

- zinc plated steel 3500 nipple with carbon steel ferrule
- can be crimped or swaged-on to achieve maximum coupling sealing and retention, for crimp dimensions see dixonvalve.com
- low profile, streamline appearance

Hose Size	Male NPT	Hose OD		Part #	Steel Price/E
		From	To		
3/8"	1/4"	46/64"	50/64"	3505WF	\$16.20
3/8"	1/2"	46/64"	50/64"	3508WF	18.90
1/2"	1/4"	54/64"	58/64"	3509WF	19.25
1/2"	3/8"	54/64"	58/64"	3510WF	21.00
1/2"	3/4"	54/64"	58/64"	3511WF	24.00
1/2"	1/2"	54/64"	58/64"	3512WF	23.00
3/4"	3/4"	1-10/64"	1-14/64"	3514WF	21.70
1"	1"	1-30/64"	1-34/64"	3518WF	24.55
1"	1"	1-34/64"	1-38/64"	3518WF2	24.05



Bent Stem Swivel Hose Barb

Features:

- $\frac{7}{8}$ " thread fits the following tool brands: Ingersoll-Rand, Thor, Black & Decker, Harper, Jet, Texas Pneumatic, Kent and Sullair
- $\frac{1}{2}$ " thread fits all tools with $\frac{1}{2}$ " female NPT thread
- $\frac{1}{2}$ " hose barb
- designed for normal operation at **90 PSI** at ambient temperature **70°F (21°C)**

Description	Steel		Optional Qty
	Part #	Price/E	
$\frac{7}{8}$ " - 24 thread x $\frac{1}{2}$ " hose barb	ATS7812H	\$54.10	50
$\frac{1}{2}$ " NPT thread x $\frac{1}{2}$ " hose barb	ATS1212H	54.10	50



Bent Stem Swivel Female Pipe Thread

Feature:

- $\frac{7}{8}$ " thread fits most chipping hammers
- $\frac{3}{8}$ " female pipe thread
- designed for normal operation at **90 PSI** at ambient temperature **70°F (21°C)**

Description	Steel		Optional Qty
	Part #	Price/E	
$\frac{7}{8}$ " - 24 thread x $\frac{3}{8}$ " female NPT	ATS7838F	\$81.00	25



Bent Stem Swivel Male Pipe Thread

Feature:

- $\frac{7}{8}$ " thread fits most chipping hammers
- $\frac{3}{8}$ " male pipe thread
- designed for normal operation at **90 PSI** at ambient temperature **70°F (21°C)**

Description	Steel		Optional Qty
	Part #	Price/E	
$\frac{7}{8}$ " - 24 thread x $\frac{3}{8}$ " male NPT	ATS7838M	\$54.10	50



Air Tool Swivels

Features:

- swivels at two locations so air hose can drop directly to the floor
- rated to **150 PSI** at ambient temperature **70°F (21°C)**
- do not use with percussion tools 

Size	Aluminum	
	Part #	Price/E
$\frac{1}{4}$ "	D344U ¹	\$51.50
$\frac{3}{8}$ "	D346U	142.50
$\frac{1}{2}$ "	D348U	184.50



¹ D344U is a non-marring composite.

King Cable™

Pneumatic Fittings

Features:

- must be installed in the extended position (no slack)
- cable reaches across hose fittings to provide standby safety for hose
- spring-loaded loops in the cable ends open easily to pass over the couplings for a firm grip on the hose
- no tools needed - easy to install and remove
- cables shipped with safety restraint labels attached
- highly resistant to rust and corrosion
- hose-to-hose or hose-to-rigid outlet
- maximum operating pressure: **200 PSI**
- minimizes damage to equipment and injuries to operators in the event hose, couplings or clamps fail, or there is an accidental separation of the assembly



Materials:

- For WB1, WB3, WA2, WA4, WSR1, WSR3, WSR2, WSR4, WSR1C, WB1C, WSR1E:
 - wire rope: galvanized carbon steel
 - ferrules: aluminum
 - springs: galvanized carbon steel
- For WB1SS, WA2SS, WSR1SS, WSR2SS:
 - wire rope: 304 stainless steel
 - ferrules: copper
 - springs: 304 stainless steel
- For WA2B:
 - wire rope: galvanized carbon steel
 - ferrules: copper
 - springs: galvanized carbon steel

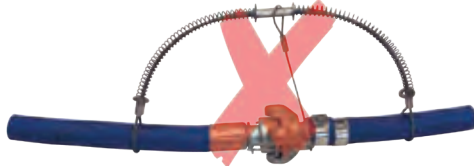

incorrect installation

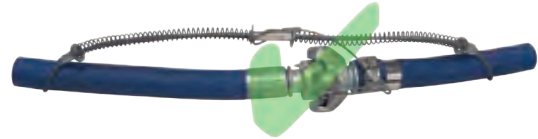

correct installation

Hose-to-Tool Service



hose end

tool end

Hose ID	Cable	Length	Maximum Working Pressure (PSI)	Steel		Stainless Steel	
				Part #	Price/E	Part #	Price/E
1/2" - 1 1/4"	1/8"	20 1/4"	200	WSR1	\$18.45	WSR1SS	\$48.25
1/2" - 2"	3/16"	28"	200	WSR3	26.50	---	---
1 1/2" - 3"	1/4"	38"	200	WSR2	29.10	WSR2SS	101.80
4"	3/8"	44"	200	WSR4	64.40	---	---

Hose-to-Hose Service



hose end

hose end

Hose ID	Cable	Length	Maximum Working Pressure (PSI)	Steel		Stainless Steel	
				Part #	Price/E	Part #	Price/E
1/2" - 1 1/4"	1/8"	20 1/4"	200	WB1	\$18.45	WB1SS	\$51.05
1/2" - 2"	3/16"	28"	200	WB3	27.35	---	---
1 1/2" - 3"	1/4"	38"	200	WA2	30.00	WA2SS	107.10
4"	3/8"	44"	200	WA4	64.45	---	---

King Cable™ Options



WB1C - WB1 with safety clip and lanyard



WSR1E - WSR1E with stainless steel marine eye

Hose ID	Cable	Part #	Description	Max. Work. Press. PSI	Price/E
1/2" - 1 1/4"	1/8"	WSR1C	WSR1 with safety clip and lanyard used to lock Air King™ couplings	200	\$32.10
1/2" - 1 1/4"	1/8"	WB1C	WB1 with safety clip and lanyard used to lock Air King™ couplings	200	31.55
1/2" - 1 1/4"	1/8"	WSR1E	WSR1 with stainless steel safety marine eye used to connect safety cable to a bolt on tool	200	59.00
1 1/2" - 3"	1/4"	WA2B	WA2 with bronze/copper ferrule for special environmental conditions	200	60.10

Nylon King Cable™

NEW

Pneumatic Fittings

Applications:

- pneumatic, hydraulic and water hoses

Features:

- strong, flexible nylon webbing
- superior corrosion and spark resistance over metal restraints
- rubber grommets securely choke eyes around hose
- must be installed in the extended position (no slack)
- shipped with labels detailing working pressures and safety instructions
- maximum working temperature: **200°F (93°C)**
- minimizes damage to equipment and injuries to operators in the event hose, couplings or clamps fail, or there is an accidental separation of the assembly
- contact Dixon at 888.226.4673 for additional options

Materials:

- strap: nylon
- grommets: rubber



Length	Recommended for use on the following hose inside diameters:								Nylon	
	¼"	½"	¾"	1"	2"	3"	4"	6"	Part #	Price/E
	Hose maximum working pressure (PSI) for above hose ID's									
30"	26,000	6,500	2,900	1,650	400	---	---	-	WBN130	\$33.45
40"	---	---	---	1,650	400	175	100	-	WBN140	36.70
30"	52,000	13,000	5,800	3,300	750	---	---	-	WBN230	50.40
64"	---	---	---	---	750	350	200	90	WBN264	72.55
44"	---	---	---	7,300	1,800	820	450	-	WBN344	144.80
64"	---	---	---	---	2,300	1,040	580	260	WBN464	184.40



King™ Safety Whipsocks

Application:

- ideally suited for applications where the media being transferred is under higher working pressures such as air, water, hydraulic and slurry

Features:

- King™ Safety Whipsocks keep the hose under control in the event of a high-pressure hose assembly failure.
- dual anchor points secured beyond the fittings eliminate hose whip
- be sure the anchoring points are rated for the application
- galvanized steel woven stockings extend down the hose to grip securely over a larger area preventing whip, abrasion and wear
- securing both eye-to-rigid or eye-to-eye anchor points reduce whip in the event of a hose connection failure
- contact Dixon® with questions regarding working pressure, available options or custom configurations



KSW32



KSW40

Materials:

- wire rope: galvanized carbon steel
- ferrules: aluminum

Size	OD Range	Length	Max. Working Pressure PSI	Part #	Price/E
3/8"	.315" - .5512"	15.75"	5000	KSW06	\$228.00
1/2"	.5512" - .7874"	21.65"	3000	KSW08	252.00
3/4"	.7874" - 1.181"	25.20"	2000	KSW12	262.00
1"	1.181" - 1.575"	34.25"	1500	KSW16	286.00
1 1/4"	1.575" - 1.969"	38.19"	1000	KSW20	320.00
1 1/2"	1.969" - 2.362"	49.21"	700	KSW24	345.00
2"	2.362" - 2.756"	51.18"	1300	KSW32	390.00
2 1/2"	2.756" - 3.346"	53.15"	800	KSW40	420.00
3"	3.346" - 3.937"	72.44"	750	KSW48	570.00
3 1/2"	3.937" - 4.724"	72.05"	550	KSW56	670.00
4"	4.724" - 5.512"	86.61"	550	KSW64	750.00
6"	5.512" - 7.087"	93.31"	250	KSW96	790.00

King™ Safety Shackles

Applications:

- 2 shackles are used to anchor the King™ Safety Whipsock
- securing both eyes to a rigid anchor point to reduce whip in the event of a hose or connection failure

Features:

- recommended bolt, nut, and cotter pin style shackle
- caution working load must be rated for the application



Size	Working Load	Fits KSW Eye	Micro Alloy Steel Part #	Price/E
1/4"	1/2 ton (1000 lbs)	KSW06-KSW12	KSS04	\$29.50
3/8"	1 1/2 ton (3000 lbs)	KSW16-KSW40	KSS06	45.60
1/2"	3 ton (6000 lbs)	KSW48-KSW96	KSS08	47.00

NEW

ASME Air Receiver Manifold
with King™ Safety Whipsock for Supply Hose**Features:**

- built to ASME Code, National Board registered
- conforms to OSHA standards 1910.169 and 1926.306
- 7 gallon capacity
- painted supply orange
- all openings are female NPT thread
- working pressure: **200 PSI**
- includes **KSW32** 2" King™ Safety Whipsock for Air Supply Hose
- shackles included to attach King™ Safety Whipsock to frame



Qty	Part #	Price/E
1	1217AR-4AK-KSW	\$4016.45

ASME Air Receiver Manifold

Features:

- built to ASME Code, National Board registered
- conforms to OSHA standards 1910.169 and 1926.306
- 7 gallon capacity
- painted safety orange
- all openings are female NPT thread
- working pressure: **200 PSI**



1217AR-4AK



1217AR-4FR

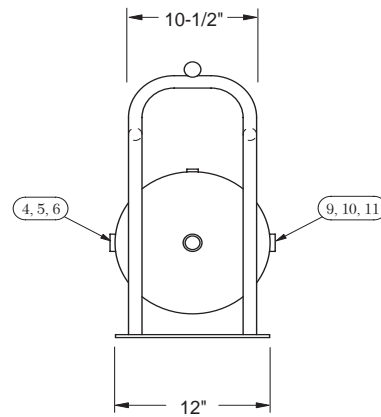
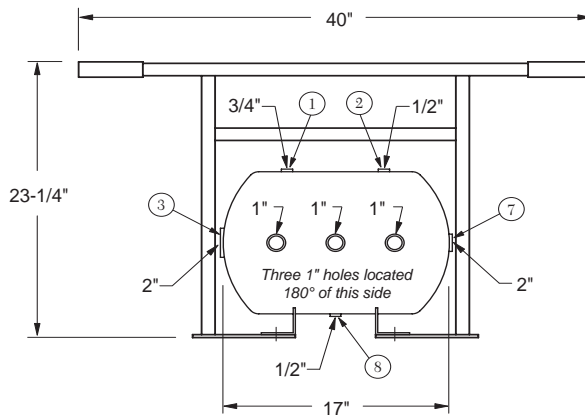

Dixon® 1217AR-4AK air receiver manifold assembly with Air King™ outlet ports includes the following components:

Part # / Locations	Qty	Description	Price/E	Price
1217AR-4	1	ASME compressed air receiver	---	\$1230.00
1217FRAME	1	protective frame	---	425.00
Location 1	1	3731204C 3/4" male x 1/4" female hex bushing	\$7.85	7.85
	1	GL345 0-300 PSI gauge	18.95	18.95
Location 2	1	3730804C 1/2" male x 1/4" female hex bushing	4.27	4.27
	1	SV200 safety pop-off valve	35.75	35.75
Location 3	1	GM28 2" male spud	54.00	54.00
	1	B27SC wing nut cap	82.25	82.25
Locations 4, 5, 6, 9, 10, 11	6	HB1075G 1" male x 3/4" female bushings	6.75	40.50
	6	3701212C 3/4" brass hex nipples	7.50	45.00
	6	BBLV75 ball valves	70.40	422.40
	6	SCVS6 safety shut-off valves	103.75	622.50
	6	AM7 Air King™ universal couplings	8.70	52.20
Location 7	4	SE45100 45° street elbow (1 each in locations 4, 6, 9 and 11 only)	9.55	38.20
	1	HB2075 2" male x 3/4" female bushing	8.75	8.75
	1	3701212C 3/4" brass hex nipples	7.50	7.50
	1	BBLV75 ball valve	70.40	70.40
	1	SCVS6 safety shut-off valve	103.75	103.75
Location 8	1	AM7 Air King™ universal coupling	8.70	8.70
	1	3730804C 1/2" male x 1/4" female hex bushing	4.27	4.27
	1	D04 1/4" drain cock	5.05	5.05
	---	Labor cost for assembly of complete unit	---	320.00
1217AR-4AK	1	7 gallon ASME compressed air receiver manifold complete assembly with Air King™	---	3535.25
Tank and Frame only				
1217AR-4FR	1	7 gallon ASME compressed air receiver with frame only	---	\$1655.00

ASME Air Receiver Manifold Assembly with Air King™ Fittings & Watts Filter



Application:

- Designed to remove compressed air contaminants such as water, compressor oil, dirt, pipe scale and water particles from the air supply at the point of entry into the ASME air receiver manifold.

Features:

- includes basic 1217AR-4AK ASME manifold assembly
- F602-16WJR 2" auto drain filter with 26 ounce metal bowl and related plumbing installed on the inlet port of the ASME air receiver manifold
- air supply hose connects directly to GM28 2" male spud on the filter air inlet
- includes a B27SC wing nut cap with a chain

Hose Size	Thread	Part #	Price/E
2"	3/4"	1217AR-4AKWF	\$4995.00

Bar Manifolds



Features:

- can be mounted on a wall or work bench, safely distributing four hose lines to a work area
- maximum operating pressure: **300 PSI** at ambient temperature **70°F (21°C)**
- brass hex head plugs sold on page J-20

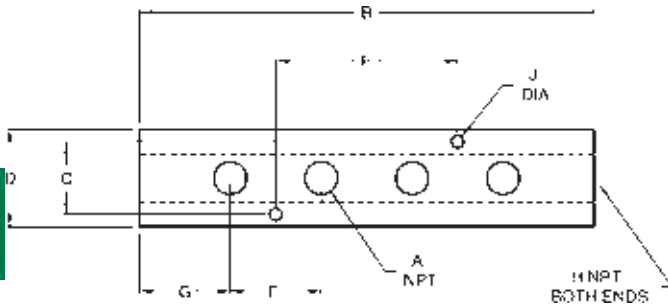

Aluminum		A	B	C	D	E	F	G	H	J
Part #	Price/E									
AMF32	\$74.10	1/4"	7 5/8"	7/8"	1 1/4"	1 7/8"	3 3/4"	1"	3/8"	.20"
AMF42	74.10	1/4"	7 5/8"	1 1/8"	1 1/2"	1 7/8"	3 3/4"	1"	1/2"	.20"
AMF43	74.10	3/8"	8"	1 1/8"	1 1/2"	2"	4"	1"	1/2"	.20"

3 in 1 Manifolds

Features:

- supplies 3 air operated tools from a single hose permitting use of air by more than one mechanic
- can be mounted to a pipe at workbench or overhead
- different tools in the shop use different styles of couplers, mount 3 different style couplers on one manifold



NPT Inlet (1)	NPT Outlets (3)	Aluminum	
		Part #	Price/E
1/4"	1/4"	D3404	\$18.55
3/8"	1/4"	D3406	17.80
1/2"	1/4"	D3408	18.55

Flat Hex Manifolds

Feature:

- designed to lay flat on the floor, safely distributing three hose lines to the work area

NPT Inlet (1)	NPT Outlets (3)	Brass	
		Part #	Price/E
1/4"	1/4"	3122	\$20.00
3/8"	1/4"	3132	23.75
3/8"	3/8"	3133	27.50

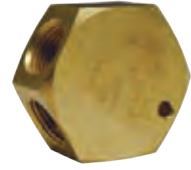

Compressor Y

Feature:

- converts a single supply source to a dual outlet

Female NPT Inlet (1)	Male NPT Outlets (2)	Iron	
		Part #	Price/E
1"	3/4"	Y10075	\$59.75



Anti-Freeze Lubricants

Application:

- winter grade air tool lubricant prevents air line, air tool and in-line lubricator freeze-up

Features:

- can be poured directly into tool or used with air line lubricators
- minimum temperature **-45°F (-43°C)**

Size	Part #	Price/E	Optional Qty
1 pint	DATL016W	\$27.75	12
1 gallon	DATL128W	167.00	4



pint



gallon



Air Tool Lubricants

Application:

- high grade lubricant prolongs the service life of air tools, cylinders and accessories

Features:

- #10 weight lubricant
- compound is superior in performance to ordinary lubricants
- prohibits rust and removes moisture as it lubricates
- non-corrosive, non-reactive and does not decompose
- easy pour spout helps prevent costly spills
- use with the in-line lubricators on page G-52

Size	Part #	Price/E	Optional Qty
1 pint	DATL016	\$17.20	12
1 gallon	DATL128	74.00	4



pint



gallon

In-Line Lubricators

**Features:**

- protects portable or stationary air tools by efficiently oiling the tool mechanisms; each time an air tool is operated a fine mist of oil is injected into it along with the air from the compressor
- installation is recommended within 25' of the tool to be lubricated, refer to the arrow for proper air flow direction
- transparent sight disc allows visual inspection of oil level
- oil flow regulated by screwdriver screw adjustment, minimum flow rate is 30 SCFM
- not recommended for constant flow applications
- for reciprocating tools only
- type of oil to use: any petroleum-based, non-detergent light weight oil (SAE 10/150SSU) which will readily break up into a mist, i.e., Mobil DTE light or comparable oil, do not use any synthetic oil or oils containing additives or solvents
- see page F-51 for air tool lubricant



NPT Size	Oil Capacity	Maximum Working Pressure at ambient temperature (70°F)	Air Flow at 70 PSI	Aluminum	
				Part #	Price/E
½"	1.4 fluid ozs.	500 PSI	30 SCFM	PL300	\$111.80
¾"	3.7 fluid ozs.	200 PSI	70 SCFM	PL400	116.90
¾"	11.0 fluid ozs.	300 PSI	70 SCFM	PL400L	145.00
1"	16.0 fluid ozs.	250 PSI	100 SCFM	PL500	193.40

Replacement Parts

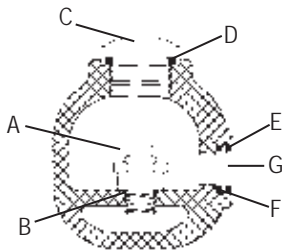

Description	Part #	Price/E
(A) oil adjustment valve assembly	851661	\$46.00
(B) valve gasket	452531	2.75
(C) fill plug	452525	14.00
(D) fill plug O-ring	700013-214	2.00
(E) sight disk	452532	2.90
(F) sight disk seal	700013-016	2.30
(G) sight disk lock nut	452533	6.75

In-Line Air Filter

**Features:**

- protects small air tools, such as impact wrenches, nut runners, grinders and screwdrivers
- all-anodized, compact housing
- install directly before the air tool
- maximum operating pressure: **500 PSI**
- temperature range: **35°F to 200°F (2°C to 93°C)**
- air flow: 140 SCFM
- male x female configuration
- standard 40 micron element ensures minimum pressure drop
- elements can be replaced quickly

Male NPT	Overall Length	Diameter	Aluminum	
			Part #	Price/E
¾"	3-13/16"	1½"	9076M	\$77.60

Disposable In-Line Nipple Filters

Features:

- for filtration of water, oil and air
- compact and lightweight
- can be installed at point of use
- shape element is conical rather than disc, providing a larger filtering flow and a true, uninterrupted axial flow
- maximum operating pressure: **300 PSI**
- temperature range: **35°F to 300°F (1.7°C to 149°C)**
- standard 40 micron element ensures minimum pressure drop



Male NPT	Overall Length	Hex	Air Flow	Brass	
				Part #	Price/E
1/4"	1 1/2"	9/16"	20 SCFM	ASP3102-40	\$16.90
1/2"	2"	7/8"	50 SCFM	ASP3104-40	22.00

In-Line Lubricator with Filter

Feature:

- consists of **9076M** particle filter with 40 micron sintered bronze element and **PL400** (3.7 ounce) or **PL400L** (11.0 ounce) lubricator

NPT Size	Oil Capacity	Max. Working Pressure at ambient temperature 70°F (21°C)	Aluminum	
			Part #	Price/E
3/4"	3.7 fluid ozs.	200 PSI	PL400WF	\$197.10
1"	11.0 fluid ozs.	300 PSI	PL400LWF	223.25



Mini In-Line Lubricators

Features:

- can be refilled under line pressure
- oil capacity: 1/4 fluid ounce
- flow rating: 22 SCFM at 100 PSIG
- maximum operating pressure: **200 PSIG**
- maximum temperature: **150°F (66°C)**

Female NPT Inlet	Outlet	Aluminum	
		Part #	Price/E
1/4"	1/4" female NPT	ML200	\$87.00
1/4"	1/4" male NPT	ML200M	87.00
3/8"	3/8" male NPT	ML300M	87.00



Mini In-Line Filter

**Features:**

- either port may be used as an inlet port
- filter element rated at 5 microns
- flow rating: 17 SCFM inlet pressure at 100 PSIG
- maximum operating pressure: **200 PSIG**
maximum temperature: **175°F (79°C)**

Female NPT	Male NPT	Aluminum	
		Part #	Price/E
1/4"	1/4" female NPT	MF200	\$46.25

Replacement Element



Description	Part #	Price/E
with O-ring	FRP-95-199	\$14.50

Series 1 Non-Repairable General Purpose Regulators

**Features:**

- relieving piston allows reduction of downstream pressure when system is dead-ended
- reliable pressure regulation at air flows up to 13 SCFM
- left to right flow
- 5 to 125 PSIG outlet pressure adjustment range
- compact design and light weight construction
- wrench flats for easy installation
- supplied with a GC620 gauge

Female NPT	With Gauge		Without Gauge	
	Part #	Price/E	Part #	Price/E
1/4"	R46-200RG	\$67.05	R46-200R	\$50.35

Safety Blow Guns

Safety blow guns have a safety tip which prevents buildup of tip pressure in the event the outlet is obstructed or "dead ended". They comply with the requirements for OSHA 1910.242 (B) and 1910.95 when used on air lines of 150 PSI or less.



Features:

- design comfortably fits contour of the hand minimizing user fatigue
- ergonomic large lever with black vinyl grip allows for easy air flow activation
- ¼" female NPT inlet

Air Chief

The air chief safety blow gun is designed to conform to OSHA Standard 1910.242 (B) permitting a maximum of 30 PSI outlet pressure when dead ended based on a maximum of 150 PSI inlet pressure as well as OSHA Standard 1910.95 regulating occupational noise level exposure. *Safety glasses or shield must be worn when using any blow gun.*



Features:

- recessed internal slotted screw allows easy access to valve assembly for repairs or replacement
- chrome plated zinc die cast body, nickel plated steel lever, vinyl thumb grip, stainless steel spring, brass valve, Buna-N seals and nickel plated brass tip combine for superior corrosion resistance



Part #	Price/E
D204-30	\$20.10

Premium

The premium safety blow gun is designed to conform to OSHA Standard 1910.242 (B) permitting a maximum of 30 PSI outlet pressure when dead ended based on a maximum of 150 PSI inlet pressure as well as OSHA Standard 1910.95 regulating occupational noise level exposure. *Safety glasses or shield must be worn when using any blow gun.*



Feature:

- zinc die cast body with a black powder coat finish, nickel plated steel lever, vinyl thumb grip, stainless steel spring, brass valve, Buna-N seals and nickel plated brass tip



Part #	Price/E
D204-30P	\$20.85

Air Booster

The multiple holes in the safety booster tip of the safety air booster gun create a Venturi effect that increases air flow (working capacity) while still remaining compliant with OSHA Standard 1910.242 (B). *Safety glasses or shield must be worn when using any blow gun.*



Feature:

- chrome plated zinc die cast body, nickel plated steel lever, vinyl thumb grip, stainless steel spring, brass valve, Buna-N seals and nickel plated brass tip provide superior corrosion resistance



Part #	Price/E
D204-30SB	\$23.90

Pistol Grip

Pneumatic Fittings

**Features:**

- conforms to US Department of Labor, OSHA Standard 1910.242 (B) allowing a maximum of 30 PSI outlet pressure at the nozzle when dead-ended
- conforms to US Department of Labor, OSHA Standard 1910.95 regulating noise level exposure
- contoured pistol-grip for safe, comfortable handling, even with greasy hands
- convenient hang-up hook
- ¼" female NPT inlet
- *Safety glasses or shield must be worn when using any blow gun.*



Part #	Price/E
PG700	\$57.90

Extended Nozzle Pistol Grip

**Features:**

- conforms to US Dept. of Labor, OSHA Standard 1910.242 (B) allowing a maximum of 30 PSI outlet pressure at the nozzle when dead-ended
- conforms to US Dept. of Labor, OSHA Standard 1910.95 regulating noise level exposure
- slender 4" extended nozzle allows access to hard to reach places and holes as small as .200"
- variable output trigger enables user to control air flow
- hook design near trigger provides finger protection as well as easy storage
- lightweight to help minimize user fatigue.
- side holes allow air to escape if nozzle tip is dead-ended, thus preventing back pressure buildup
- pressure rating: **150 PSI**
- ¼" female NPT inlet
- *Safety glasses or shield must be worn when using any blow gun.*



Part #	Price/E
ENBG1	\$38.55

Safety Tip

Features:

- ⅛" male NPT connection
- can be used with all Dixon® Air Chief lever operated blow guns as well as most blow guns from other manufacturers



<i>Nickel Plated Brass</i>	
Part #	Price/E
SST10	\$3.25

Rubber Non-Safety Tip

Features:

- ⅛" male NPT connection
- can be used with all Dixon® Air Chief lever operated blow guns as well as most blow guns from other manufacturers



<i>Rubber Coated Nickel Plated Brass</i>	
Part #	Price/E
D201RT	\$8.25

Non-Safety Blow Gun

Non-Safety blow guns **do not** have a safety by-pass to prevent buildup of tip pressure in the event of tip blockage. They may be used for cleaning purposes only if the air supply (inlet pressure) has been reduced to 30 PSI or less.



Features:

- designed to comfortably fit the contour of the hand, minimizing user fatigue
- ergonomic large lever with vinyl grip allows for easy air flow activation
- ¼" female NPT inlet

Brass Tip

The ventless, nickel-plated tip provides the most economical means of achieving a concentrated stream of air for many blow-off applications. All other components and design features are the same as our Air Chief safety blow gun (D204-30). *Must be used on air lines having a maximum regulated pressure of 30 PSI in order to comply with OSHA Standard 1910.242 (B). Safety glasses or shield must be worn when using any blow gun.*



Feature:

- chrome plated zinc die cast body, nickel plated steel lever, vinyl thumb grip, stainless steel spring, brass valve, Buna-N seals and ventless, nickel plated brass tip provide superior corrosion resistance



Part #	Price/E
D605	\$18.95

Rubber Tip

The rubber tip will not scratch or mar delicate surfaces. The conical, rubber tip can also be used to create a seal between the blow gun and fluid lines (or any other opening). Base of the tip is nickel-plated brass for additional corrosion resistance. *Must be used on air lines having a maximum regulated pressure of 30 PSI in order to comply with OSHA Standard 1910.242 (B). Safety glasses or shield must be worn when using any blow gun.*



Feature:

- chrome plated zinc die cast body, nickel plated steel lever, vinyl thumb grip, stainless steel spring, brass valve, Buna-N seals and rubber tip with a nickel plated brass base provide superior corrosion resistance



Part #	Price/E
D201	\$22.45

Extensions

Features:

- supplied with ½" male NPT connections
- allow easier access to blow-off applications in high or hard to reach places
- can be used with all Dixon® Air Chief lever operated blow guns as well as most blow guns from other manufacturers
- brass base with a rugged steel extension tube, all nickel plated

Size Extension	Part #	Price/E
6"	BGE6	\$14.70
10"	BGE10	18.40
12"	BGE12	19.90
18"	BGE18	30.35
24"	BGE24	33.25



Heavy Duty - **High Volume** Safety Blow Guns

Features:

- heavy duty - high volume safety blow guns
- requires high volume coupler and plug for optimum performance
- lightweight and ergonomic
- pistol grip / hanging hook handle
- made from high quality aluminum casting
- maximum operating pressure: **150 PSI**
- ¼" female NPT inlet
- *Safety glasses or shield must be worn when using any blow gun.* 

Heavy Duty - **High Volume with** Safety Tip

Features:

- reduced to 30 PSI when tip is blocked
- The safety air booster blow gun has a safety tip which prevents buildup of tip pressure in the event the outlet obstructed or "dead ended". It complies with the requirements for OSHA 1910.242 (B) and 1910.95 when used on air lines of 150 PSI or less. 



HTBG6

Description	Part #	Price/E
gun with <i>no</i> extension	HTBG	\$64.95
gun with 6" extension	HTBG6	66.50
gun with 12" extension	HTBG12	69.35
gun with 24" extension	HTBG24	74.55
gun with 36" extension	HTBG36	81.80

Heavy Duty-High Volume with Quiet Conical Tip



Feature:

- 6.0 CFM

Description	Part #	Price/E
gun with tip only	HTBG-CT	\$56.95

Accessories



HTBGC

Female NPT Inlet (1)	Aluminum		Brass	
	Part #	Price/E	Part #	Price/E
6" extension with safety tip	HTBG6EXT	\$41.40	---	---
12" extension with safety tip	HTBG12EXT	44.55	---	---
24" extension with safety tip	HTBG24EXT	50.50	---	---
36" extension with safety tip	HTBG36EXT	56.45	---	---
safety tip	HTBGS	29.00	---	---
conical tip	HTBGC	29.50	---	---
tip adapter	HTBGA	8.00	---	---
high flow female coupler	---	---	2CJF2-B	\$16.80
high flow male plug	---	---	CJ2M2-B	3.58

High Volume Typhoon Blow Guns

Features:

- chrome plated aluminum body
- variable flow control
- 1/4" female NPT inlet
- 34 CFM at 125 PSI
- Compliant with OSHA Standard 1910.242 (B). *Safety glasses or shield must be worn when using any blow gun.*



Description	Part #	Price/E
gun with no extension	TYP2501	\$79.45
gun with 6" extension	TYP2501-6	90.75
gun with 12" extension	TYP2501-12	90.85
gun with 24" extension	TYP2501-24	95.75
gun with 36" extension	TYP2501-36	104.15

High Volume Cannon® Blow Gun

Application:

- designed for, but not limited to, outdoor use, ideal where a large air supply is available to move heavy, stubborn debris

Features:

- 3/4" female NPT inlet
- minimum inlet pressure 90 PSI on 1/2" hose
- consumes 135 CFM at 100 PSI
- 48" long extension
- compliant with OSHA Standard 1910.242 (B)
- *Safety glasses or shield must be worn when using any blow gun.*



Part #	Price/E
9000-48S	\$418.00



Heavy Duty Tire Pressure Gauge

Features:

- 12" hose with swivel dual foot chuck inflator
- tapered chuck nut fits wheel cover holes on cars and light trucks
- calibrated in 2 PSI increments from **10 to 120 PSI**

Part #	Price/E
D101	\$100.20

Passenger Car Tire Pressure Gauge

Features:

- 12" hose with straight-on chuck
- straight chuck nut fits wheel cover holes on cars and light trucks
- ideal for use on wells and reels
- calibrated in 2 PSI increments from **10 to 90 PSI**

Part #	Price/E
D150	\$74.50

Professional Tire Pressure Gauge

Features:

- permanently lubricated
- easy to read, dual calibrated (PSI and kPa), four-sided nylon indicator bar
- body is made of chrome-plated brass, head is chrome-plated zinc
- pocket clip
- calibrated in 1 PSI increments from **5 to 45 PSI**

Part #	Price/E
DFG5	\$12.50

Dual Foot Tire Pressure Gauges

Features:

- handy pocket clip
- calibrated in 2 PSI increments from **20 to 120 PSI**

Part #	Price/E
DFG1	\$17.70

Features:

- heavy duty hang-up ring
- calibrated in 2 PSI increments from **10 to 150 PSI**

Part #	Price/E
DFG2	\$35.80

Tire Inflator Chuck

Features:

- ball foot chuck
- for direct connection to live air only
- features a built-in shutoff valve (will not work on inflator gauges)
- ¼" NPT female thread
- maximum pressure is **150 PSI**

Part #	Brass	Price/E	Optional Qty
D104		\$8.40	10

Wilkerson Miniature Filters F03

Features:

- excellent water removal efficiency
- 5 micron element
- .5 oz. bowl
- maximum operating conditions:
 - transparent bowl: **150 PSIG** (10.3 bar) and **32°F to 125°F (0°C to 52°C)**
 - metal bowl: **250 PSIG** (17.2 bar) and **32°F to 175°F (0°C to 80°C)**

Port Size	Flow (SCFM)	With Transparent Bowl				With Metal Bowl			
		Automatic Drain		Manual Drain		Automatic Drain		Manual Drain	
		Part #	Price/E	Part #	Price/E	Part #	Price/E	Part #	Price/E
1/8"	22	F03-01A	\$61.50	F03-01M	\$51.70	F03-01AMB	\$69.70	F03-01MMB	\$59.60
1/4"	24	F03-02A	61.50	F03-02M	51.70	F03-02AMB	69.70	F03-02MMB	59.60

SCFM ratings at 90 PSIG inlet pressure.



transparent bowl

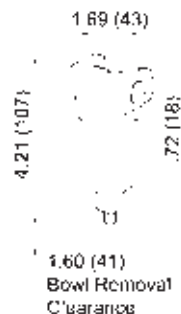

Pneumatic Fittings

Wilkerson Miniature Filters F08

Features:

- 5 micron element
- .4 oz. bowl
- maximum operating conditions:
 - transparent bowl: **150 PSIG** (10.3 bar) and **32°F to 125°F (0°C to 52°C)**
 - metal bowl: **250 PSIG** (17.2 bar) and **32°F to 150°F (0°C to 65.5°C)**

Port Size	Flow (SCFM)	With Transparent Bowl and Guard				With Metal Bowl			
		Automatic Drain		Manual Drain		Automatic Drain		Manual Drain	
		Part #	Price/E	Part #	Price/E	Part #	Price/E	Part #	Price/E
1/4"	50	F08-02A	\$64.25	F08-02M	\$54.10	F08-02AMB	\$68.30	F08-02MMB	\$60.60

See pages G-85 to G-89 for accessories.

SCFM ratings at 150 PSIG inlet pressure.



metal bowl



Wilkerson Miniature Regulators R03

Features:

- 2-125 PSI adjusting range
- balanced valve design
- self-relieving standard
- non-rising push/pull locking adjustment knob
- two 1/8" NPT gauge ports standard on models without gauge, one 1/8" NPT gauge port standard on models with gauge - can be used for additional outlet ports.
- models supplied without gauge use a GC620 gauge.
- panel mount nuts sold separately
- maximum operating conditions:
 - 300 PSIG** (20.17 bar) and **32°F to 125°F (0°C to 52°C)**

Size	Flow (SCFM)	With Gauge		Without Gauge	
		Part #	Price/E	Part #	Price/E
1/8"	13	R03-01RG	\$56.35	R03-01R	\$39.65
1/4"	15	R03-02RG	56.35	R03-02R	39.65

SCFM ratings at 100 PSIG inlet pressure.



See pages G-85 to G-89 for accessories.

FRL's are designed for air service only, unless otherwise indicated.

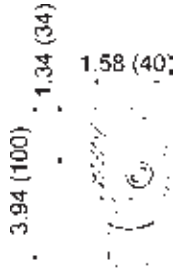

Wilkerson Miniature Regulators R08

Features:

- 0-125 PSI adjusting range
- balanced valve design
- self-relieving standard
- non-rising push/pull locking adjustment knob
- two 1/8" NPT gauge ports standard on models without gauge, one 1/8" NPT gauge port standard on models with gauge - can be used for additional outlet ports.
- models with gauge are supplied with a 0-160 flush mount style gauge
- models supplied without gauge use a GC620 gauge.
- panel mount nuts sold separately
- maximum operating conditions:
300 PSIG (20.7 bar) and 32°F to 150°F (0°C to 66°C)

Size	Flow (SCFM)	With Gauge		Without Gauge	
		Part #	Price/E	Part #	Price/E
1/4"	44	R08-02RG	\$66.95	R08-02R	\$47.70

SCFM ratings at 100 PSIG inlet pressure.

Wilkerson Miniature Water Regulators RB3

Features:

- 2-125 PSI adjusting range
- suitable for water and compressed air service
- brass construction - wetted parts
- non-relieving spring-loaded diaphragm
- panel mount nut included
- two 1/8" NPT gauge ports standard
- models supplied without gauge use a GC620 gauge
- maximum operating conditions:
300 PSIG (20.7 bar) and 40°F to 125°F (4°C to 52°C)

Size	Flow (SCFM)	With Gauge		Without Gauge	
		Part #	Price/E	Part #	Price/E
1/8"	11	RB3-01RG	\$71.35	RB3-01R	\$54.65
1/4"	14	RB3-02RG	71.35	RB3-02R	54.65

SCFM ratings at 100 PSIG inlet pressure.

See pages G-85 to G-89 for accessories.

Wilkerson Miniature Filters / Regulators BB3



transparent bowl



Features:

- 2-125 PSI adjusting range
- 5 micron element
- .5 oz. bowl
- self-relieving
- supplied with a GC620 gauge
- maximum operating conditions:
 - transparent bowl: **125 PSIG (8.6 bar) and 40°F to 125°F (4.4°C to 52°C)**
 - metal bowl: **300 PSIG (20.7 bar) and 40°F to 125°F (4.4°C to 52°C)**

Port Size	Flow (SCFM)	With Transparent Bowl				With Metal Bowl			
		Automatic Drain		Manual Drain		Automatic Drain		Manual Drain	
		Part #	Price/E	Part #	Price/E	Part #	Price/E	Part #	Price/E
1/8"	13	BB3-01AG	\$134.20	BB3-01MG	\$123.95	BB3-01AGMB	\$142.60	BB3-01MGMB	\$132.30
1/4"	16	BB3-02AG	134.20	BB3-02MG	123.95	BB3-02AGMB	142.60	BB3-02MGMB	132.30

SCFM ratings at 150 PSIG inlet pressure.

FRL's are designed for air service only, unless otherwise indicated.

Wilkerson Miniature Filters / Regulators B08

Features:

- 0-125 PSI adjusting range
- 5 micron element
- .4 oz. bowl
- self-relieving
- supplied with a 0-160 PSI flush mount style gauge
- maximum operating conditions:
 - transparent bowl: **150 PSIG** (10.3 bar) and **32°F to 125°F (0°C to 52°C)**
 - metal bowl: **250 PSIG** (17.2 bar) and **32°F to 150°F (0°C to 65.5°C)**

Size	Flow (SCFM)	With Transparent Bowl and Guard				With Metal Bowl			
		Automatic Drain		Manual Drain		Automatic Drain		Manual Drain	
		Part #	Price/E	Part #	Price/E	Part #	Price/E	Part #	Price/E
1/4"	42.1	B08-02AG	\$117.75	B08-02MG	\$107.90	B08-02AGMB	\$139.90	B08-02MGMB	\$130.05

See pages G-85 to G-89 for accessories.
SCFM ratings at 100 PSIG inlet pressure.



Pneumatic Fittings

metal bowl

Wilkerson Miniature Lubricators L03

Features:

- 1 oz. bowl
- adjustable oil feed
- full view sight dome
- **Do not fill under pressure. Air supply must be turned off and pressure bled from unit prior to adding oil.**
- maximum operating conditions:
 - transparent bowl: **150 PSIG** (10.3 bar) and **32°F to 125°F (0°C to 52°C)**
 - metal bowl: **250 PSIG** (17.2 bar) and **32°F to 175°F (0°C to 80°C)**



Size	Flow (SCFM)	With Transparent Bowl		With Metal Bowl	
		Part #	Price/E	Part #	Price/E
1/8"	20	L03-01A	\$78.95	L03-01AMB	\$87.15
1/4"	20	L03-02A	78.95	L03-02AMB	87.15

SCFM ratings at 90 PSIG inlet pressure.



transparent bowl



Wilkerson Miniature Lubricators L08

Features:

- .6 oz. bowl
- adjustable oil feed
- full view sight dome
- fill under pressure design
- maximum operating conditions:
 - transparent bowl: **150 PSIG** (10.3 bar) and **32°F to 125°F (0°C to 52°C)**
 - metal bowl: **250 PSIG** (17.2 bar) and **32°F to 150°F (0°C to 65.5°C)**

Size	Flow (SCFM)	With Transparent Bowl		With Metal Bowl	
		Part #	Price/E	Part #	Price/E
1/4"	57.5	L08-02A	\$76.50	L08-02AMB	\$82.30

See pages G-85 to G-89 for accessories.
See page G-51 for air tool lubricant.



metal bowl



FRL's are designed for air service only, unless otherwise indicated.

SCFM ratings at 150 PSIG inlet pressure.

Wilkerson Miniature Combination Units C03



transparent bowl

5.77 (147)

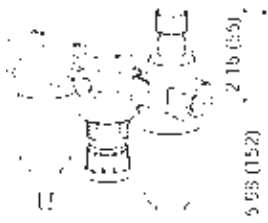

2.15 (55)

5.55 (152)

1.62 (41)
Bowl Removal
Clearance

Features:

- maximum operating conditions:
 - transparent bowl: **150 PSIG** (10.3 bar) and **32°F to 125°F (0°C to 52°C)**
 - metal bowl: **250 PSIG** (17.2 bar) and **32°F to 175°F (0°C to 80°C)**
- Included components: (2) adapters

Filter series F03:

- 5 micron element
- .5 oz. bowl

Regulator series R03:

- 2-125 PSI adjusting range
- balanced valve design
- self-relieving
- supplied with a GC620 gauge
- can be mounted with knob in up or down position

Lubricator series L03:

- 1 oz. bowl
- adjustable oil feed
- full view sight dome

Size	Flow (SCFM)	With Transparent Bowl and Guard				With Metal Bowl			
		Automatic Drain		Manual Drain		Automatic Drain		Manual Drain	
		Part #	Price/E	Part #	Price/E	Part #	Price/E	Part #	Price/E
1/8"	20	C03-01A	\$257.00	C03-01M	\$249.30	C03-01AMB	\$274.25	C03-01MMB	\$264.85
1/4"	20	C03-02A	258.05	C03-02M	248.75	C03-02AMB	273.65	C03-02MMB	264.25

SCFM ratings at 100 PSIG inlet pressure.

Wilkerson Miniature Combination Units C08



metal bowl

4.77 (120)



1.37 (35)

5.00 (127)

1.31 (33)
Bowl Removal
Clearance

Features:

- maximum operating conditions:
 - transparent bowl: **150 PSIG** (10.3 bar) and **32°F to 125°F (0°C to 52°C)**
 - metal bowl: **250 PSIG** (17.2 bar) and **32°F to 150°F (0°C to 65.5°C)**
- Included components: (2) mounting brackets with joiner set

Filter series F08:

- 5 micron element
- .4 oz. bowl

Regulator series R08:

- 0-125 PSI adjusting range
- balanced valve design
- self-relieving
- supplied with a 0-160 PSI flush mount style gauge

Lubricator series L08:

- .6 oz. bowl
- adjustable oil feed
- full view sight dome

Size	Flow (SCFM)	With Transparent Bowl and Guard				With Metal Bowl			
		Automatic Drain		Manual Drain		Automatic Drain		Manual Drain	
		Part #	Price/E	Part #	Price/E	Part #	Price/E	Part #	Price/E
1/4"	44	C08-02A	\$294.75	C08-02M	\$285.15	C08-02AMB	\$301.65	C08-02MMB	\$292.05

! FRL's are designed for air service only, unless otherwise indicated.

SCFM ratings at 100 PSIG inlet pressure.

Wilkerson Compact Airline Filters F16

Features:

- 5 micron element
- 5 oz. bowl
- maximum operating conditions:
 - transparent bowl: **150 PSIG** (10.3 bar) and **32°F to 125°F (0°C to 52°C)**
 - metal bowl: **200 PSIG** (13.8 bar) and **32°F to 150°F (0°C to 65.5°C)**

Size	Flow (SCFM)	With Transparent Bowl and Guard				With Metal Bowl			
		Automatic Drain		Manual Drain		Automatic Drain		Manual Drain	
		Part #	Price/E	Part #	Price/E	Part #	Price/E	Part #	Price/E
¼"	63.0	F16-02A	\$193.65	F16-02M	\$133.60	F16-02AMB	\$211.70	F16-02MMB	\$151.65
⅜"	74.1	F16-03A	193.65	F16-03M	133.60	F16-03AMB	211.70	F16-03MMB	151.65
½"	80.4	F16-04A	193.65	F16-04M	133.60	F16-04AMB	211.70	F16-04MMB	151.65



with guard

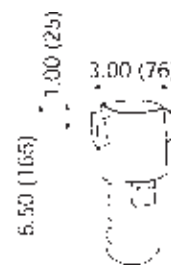

Pneumatic Fittings

Wilkerson Compact Airline Filters F18

Features:

- high flow capacity
- 5 micron element
- 4 oz. bowl
- maximum operating conditions:
 - transparent bowl: **150 PSIG** (10.3 bar) and **32°F to 125°F (0°C to 52°C)**
 - metal bowl: **250 PSIG** (17.2 bar) and **32°F to 150°F (0°C to 65.5°C)**

Size	Flow (SCFM)	With Transparent Bowl and Guard				With Metal Bowl with Sight Glass			
		Automatic Drain		Manual Drain		Automatic Drain		Manual Drain	
		Part #	Price/E	Part #	Price/E	Part #	Price/E	Part #	Price/E
¼"	110	F18-02A	\$158.75	F18-02M	\$98.65	F18-02AMB	\$165.05	F18-02MMB	\$110.85
⅜"	120	F18-03A	158.75	F18-03M	98.65	F18-03AMB	165.05	F18-03MMB	110.85
½"	145	F18-04A	158.75	F18-04M	98.65	F18-04AMB	165.05	F18-04MMB	110.85



transparent bowl with guard

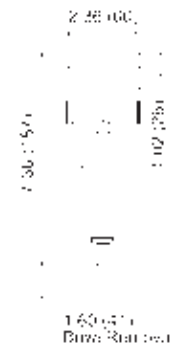

Wilkerson Standard Airline Filters F26

Features:

- 5 micron element
- 10 oz. bowl
- maximum operating conditions:
 - transparent bowl: **150 PSIG** (10.3 bar) and **32°F to 125°F (0°C to 52°C)**
 - metal bowl: **200 PSIG** (13.8 bar) and **32°F to 150°F (0°C to 65.5°C)**

Size	Flow (SCFM)	With Transparent Bowl and Guard				With Metal Bowl with Sight Glass			
		Automatic Drain		Manual Drain		Automatic Drain		Manual Drain	
		Part #	Price/E	Part #	Price/E	Part #	Price/E	Part #	Price/E
¼"	81.3	F26-02A	\$240.65	F26-02M	\$180.60	F26-02AMB	\$260.60	F26-02MMB	\$200.25
⅜"	117.8	F26-03A	240.65	F26-03M	180.60	F26-03AMB	260.60	F26-03MMB	200.25
½"	149.8	F26-04A	240.65	F26-04M	180.60	F26-04AMB	260.60	F26-04MMB	200.25



with guard

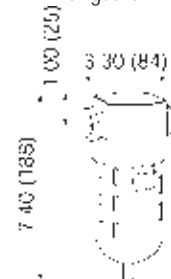

See pages G-85 to G-89 for accessories.



FRL's are designed for air service only, unless otherwise indicated.

SCFM ratings at 150 PSIG inlet pressure.



with metal bowl

Wilkerson Standard Airline Filters F28

Features:

- high flow capacity
- 5 micron element
- 6 oz. bowl
- maximum operating conditions:
 - transparent bowl: **150 PSIG** (10.3 bar) and **32°F to 125°F (0°C to 52°C)**
 - metal bowl: **250 PSIG** (17.2 bar) and **32°F to 150°F (0°C to 65.5°C)**

Size	Flow (SCFM)	With Transparent Bowl and Guard				With Metal Bowl with Sight Glass			
		Automatic Drain		Manual Drain		Automatic Drain		Manual Drain	
		Part #	Price/E	Part #	Price/E	Part #	Price/E	Part #	Price/E
3/8"	144	F28-03A	\$196.15	F28-03M	\$135.80	F28-03AMB	\$202.15	F28-03MMB	\$147.95
1/2"	160	F28-04A	196.15	F28-04M	135.80	F28-04AMB	202.15	F28-04MMB	147.95
3/4"	165	F28-06A	196.15	F28-06M	135.80	F28-06AMB	202.15	F28-06MMB	147.95



with guard

Wilkerson Jumbo Airline Filters F30

Features:

- 5 micron element
- 1 qt. bowl
- maximum operating conditions:
 - transparent bowl: **150 PSIG** (10.3 bar) and **32°F to 125°F (0°C to 52°C)**
 - metal bowl: **200 PSIG** (13.8 bar) and **32°F to 150°F (0°C to 65.5°C)**

Size	Flow (SCFM)	With Transparent Bowl and Guard				With Metal Bowl with Sight Glass			
		Automatic Drain		Manual Drain		Automatic Drain		Manual Drain	
		Part #	Price/E	Part #	Price/E	Part #	Price/E	Part #	Price/E
3/4"	316	F30-06A	\$365.20	F30-06M	\$305.10	F30-06AMB	\$424.75	F30-06MMB	\$364.40
1"	323	F30-08A	365.20	F30-08M	305.10	F30-08AMB	424.75	F30-08MMB	364.40



with metal bowl

Wilkerson Jumbo Airline Filters F35

Features:

- 5 micron element
- 1 qt. bowl
- maximum operating conditions:
 - metal bowl: **150 PSIG** (10.3 bar) and **32°F to 150°F (0°C to 65.5°C)**

Size	Flow (SCFM)	With Heavy Duty Metal Bowl			
		Automatic Drain		Manual Drain	
		Part #	Price/E	Part #	Price/E
1 1/2"	1280	F35-0BAMB	\$1435.80	F35-0BMMB	\$1375.70
2"	1400	F35-0CAMB	1435.80	F35-0CMMB	1375.70

See pages G-85 to G-89 for accessories.

FRL's are designed for air service only, unless otherwise indicated.

SCFM ratings at 150 PSIG inlet pressure.

Wilkerson Compact Modular Coalescing Filters M16

- removes extremely fine oil mists, oil aerosols and microscopic particles
- A standard airline filter should be installed as a pre-filter when using a coalescing filter.
- 0.5 micron type B and 0.003 micron type D elements are optional
- differential pressure indicator changes from green to red with pressure loss



with guard

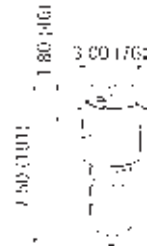

Features:

- 0.01 micron type C element
- 5 oz. bowl
- can be installed in modular system
- maximum operating conditions:
150 PSIG (10.3 bar) and 32°F to 125°F (0°C to 52°C)

Size	Flow (SCFM)	With Compact Transparent Bowl and Guard			
		Automatic Drain		Manual Drain	
		Part #	Price/E	Part #	Price/E
1/4"	37.0	M16-02A	\$305.35	M16-02M	\$245.00
3/8"	44.7	M16-03A	305.35	M16-03M	245.00
1/2"	46.1	M16-04A	305.35	M16-04M	245.00

Wilkerson Compact Modular Coalescing Filters M18

Features:

- high-efficiency removal of water, oil aerosols, and solid particulate contaminants down to 0.01 mg/m³ with minimum pressure drop
- modern design and appearance
- light weight
- high flow capacity
- 4 oz. bowl
- maximum operating conditions:
150 PSIG (10.3 bar) and 32°F to 125°F (0°C to 52°C)



with guard



Size	Flow (SCFM)	With Compact Transparent Bowl and Guard			
		Automatic Drain		Manual Drain	
		Part #	Price/E	Part #	Price/E
1/4"	40.0	M18-02A	\$252.95	M18-02M	\$192.85
3/8"	44.0	M18-03A	252.95	M18-03M	192.85
1/2"	48.0	M18-04A	252.95	M18-04M	192.85

Wilkerson Standard Modular Coalescing Filters M26

Features:

- 0.01 micron type C element
- 10 oz. bowl
- can be installed in modular system
- maximum operating conditions:
150 PSIG (10.3 bar) and 32°F to 125°F (0°C to 52°C)



with guard



Size	Flow (SCFM)	With Standard Transparent Bowl and Guard			
		Automatic Drain		Manual Drain	
		Part #	Price/E	Part #	Price/E
1/4"	55.0	M26-02A	\$373.65	M26-02M	\$313.55
3/8"	65.5	M26-03A	373.65	M26-03M	313.55
1/2"	79.5	M26-04A	373.65	M26-04M	313.55

See pages G-85 to G-89 for accessories.



FRL's are designed for air service only, unless otherwise indicated.

SCFM ratings at 150 PSIG inlet pressure.

Wilkerson Standard Modular Coalescing Filters M28



with guard



- removes extremely fine oil mists, oil aerosols and microscopic particles
- A standard airline filter should be installed as a pre-filter when using a coalescing filter.
- 0.5 micron type B and 0.003 micron type D elements are optional
- differential pressure indicator changes from green to red with pressure loss



Features:

- high-efficiency removal of water, oil aerosols, and solid particulate contaminants down to 0.01 mg/m³ with minimum pressure drop
- modern design and appearance
- light weight
- high flow capacity
- 6 oz. bowl
- maximum operating conditions:
150 PSIG (10.3 bar) and 32°F to 125°F (0°C to 52°C)

Size	Flow (SCFM)	With Compact Transparent Bowl and Guard			
		Automatic Drain		Manual Drain	
		Part #	Price/E	Part #	Price/E
3/8"	82.0	M28-03A	\$296.35	M28-03M	\$236.30
1/2"	90.0	M28-04A	296.35	M28-04M	236.30
3/4"	98.0	M28-06A	296.35	M28-06M	236.30

Wilkerson Jumbo Modular Coalescing Filters M30



with guard



Features:

- 0.01 micron type C element
- 1 qt. bowl
- maximum operating conditions:
150 PSIG (10.3 bar) and 32°F to 125°F (0°C to 52°C)

Size	Flow (SCFM)	With Jumbo Transparent Bowl and Guard	
		Automatic Drain	
		Part #	Price/E
1/2"	123	M30-04A	\$637.75
3/4"	173	M30-06A	637.75
1"	203	M30-08A	637.75

See pages G-85 to G-89 for accessories.



FRL's are designed for air service only, unless otherwise indicated.

SCFM ratings at 150 PSIG inlet pressure.

Wilkerson Heavy Duty Modular Coalescing Filters M35

- for removal of extremely fine oil mists, oil aerosols and microscopic particles
- A standard airline filter should be installed as a pre-filter when using a coalescing filter.
- 1.0 micron type B1 and 0.003 micron type D elements are optional
- differential pressure indicator changes from green to red with pressure loss



M35-0CAMB

Pneumatic Fittings

Features:

- 0.01 micron type C element
- 1 qt. bowl
- differential pressure indicator eliminates the guesswork of element placement
- maximum operating conditions:
150 PSIG (10.3 bar) and 32°F to 150°F (0°C to 65.5°C)

Size	Flow (SCFM)	With Metal Bowl	
		Part #	Price/E
1½"	710	M35-0BAMB	\$1948.35
2"	710	M35-0CAMB	1948.35



See pages G-85 to G-89 for accessories.



FRL's are designed for air service only, unless otherwise indicated.

SCFM ratings at 150 PSIG inlet pressure.





with transparent bowl

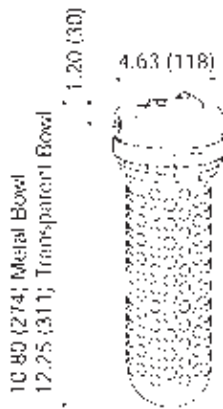

Wilkerson Manual In-Line Desiccant Dryers

Applications:

- Manual air dryers are used to remove water vapor from compressed air systems, in applications such as paint spraying, laboratory instruments and small control air systems. Filtration for absorber type dryers is important to protect the desiccant bed from contamination. Cleaner incoming air will result in better performance, longer life and fewer service problems. To regenerate silica gel desiccant, it must be heated to at least **350°F (177°C)** for approximately 3 hours or until color has changed from pink to blue. Allow desiccant to cool to room temperature before pouring back into unit bowl.

An after-filter should be placed downstream from the desiccant dryer to ensure solid contaminants such as desiccant dust do not migrate downstream.



Features:

- 1.64 lb. bowl
- will dry up to 4400 standard cubic feet of air
- desiccant; good for approximately 440 minutes at maximum continuous air flow before regeneration is required
- silica gel changes from blue to pink to indicate the need to replace or regenerate the desiccant
- slotted bowl guard for visual detection of color change
- no electrical connection necessary
- provides atmospheric dew point of **-45°F (-43°C)** with dry desiccant at **100 PSI** and **70°F (21°C)**
- maximum operating conditions:
 - transparent bowl: **150 PSIG (10.3 bar)** and **125°F (52°C)**
 - metal bowl: **150 PSIG (10.3 bar)** and **150°F (66°C)**

Size	Flow (SCFM)	With Transparent Bowl		With Metal Bowl	
		Part #	Price/E	Part #	Price/E
1/4"	10	X03-02	\$369.85	X03-02MB	\$478.25

Wilkerson Dial Air Regulators R21

Dial-air regulators feature a transparent, pressure-calibrated, non-rising adjustment dial for quick adjustment of secondary pressure. The full reduced pressure range can be dialed in less than 270° of dial rotation. This feature is particularly advantageous if secondary pressure must be changed frequently. Dial air regulators can be mounted in any position so dial face is always visible. All dial-air units have a slight constant air bleed.

Features:

- 0-160 PSI adjusting range
- balanced valve design
- relieving type
- non-rising pressure adjusting dial
- piston operated
- two 1/4" NPT gauge ports standard on models without gauge, one 1/4" NPT gauge port standard on models with gauge - can be used for additional outlet ports.
- models supplied without gauge use a GC230 gauge
- maximum operating pressure: **300 PSIG (20.7 bar)**
- temperature range: **32°F to 150°F (0°C to 66°C)**

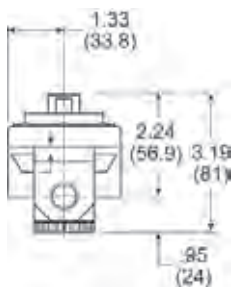

Size	Flow (SCFM)	With Gauge		Without Gauge	
		Part #	Price/E	Part #	Price/E
1/4"	117	R21-02RG	\$232.95	R21-02R	\$212.25
3/8"	180	R21-03RG	232.95	R21-03R	212.25
1/2"	195	R21-04RG	232.95	R21-04R	212.25
3/4"	220	R21-06RG	232.95	R21-06R	212.25

See pages G-85 to G-89 for accessories.



FRL's are designed for air service only, unless otherwise indicated.

SCFM ratings at 100 PSIG inlet pressure.

Wilkerson Compact Regulators R16

Features:

- 0-125 PSI adjusting range
- for 0-60 PSI adjusting range, add an L to the end of the part number
- self-relieving standard
- can be installed with the adjusting knob in any position
- To increase regulated pressure, pull adjusting knob up and turn clockwise. To reduce pressure, turn knob counter clockwise.
- two 1/4" NPT gauge ports standard on models without gauge, one 1/4" NPT gauge port standard on models with gauge - can be used for additional outlet ports
- models supplied without gauge use a GC230 gauge
- maximum operating conditions:
300 PSIG (20.7 bar) and 32°F to 150°F (0°C to 66°C)

Size	Flow (SCFM)	With Gauge		Without Gauge	
		Part #	Price/E	Part #	Price/E
1/4"	71.5	R16-02RG	\$126.45	R16-02R	\$105.75
3/8"	80.5	R16-03RG	126.45	R16-03R	105.75
1/2"	88.0	R16-04RG	126.45	R16-04R	105.75



Wilkerson High Pressure Compact Regulators R16

Features:

- 0-250 PSI adjusting range
- self-relieving standard
- non-rising push/pull locking adjustment knob
- panel mount nut standard
- excellent flow characteristics
- can be installed with the adjusting knob in any position
- two 1/4" NPT gauge ports standard on models without gauge, one 1/4" NPT gauge port standard on models with gauge - can be used for additional outlet ports
- models supplied without gauge use a GC240 gauge
- maximum operating conditions:
300 PSIG (20.7 bar) and 32°F to 150°F (0°C to 66°C)

Size	Flow (SCFM)	With Gauge		Without Gauge	
		Part #	Price/E	Part #	Price/E
1/4"	71.5	R16-02RHG	\$126.45	R16-02RH	\$105.75
3/8"	80.5	R16-03RHG	126.45	R16-03RH	105.75
1/2"	88.0	R16-04RHG	126.45	R16-04RH	105.75

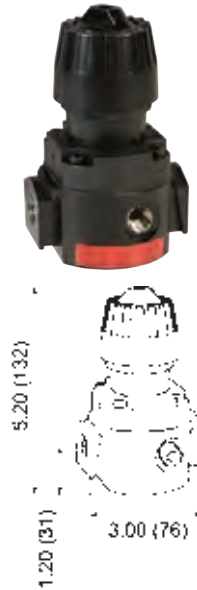

Wilkerson Compact Regulators R18

Features:

- 0-125 PSI adjusting range
- self-relieving standard
- can be installed with the adjusting knob in any position
- To increase regulated pressure, pull adjusting knob up and turn clockwise. To reduce pressure, turn knob counter clockwise.
- Two 1/4" NPT gauge ports located on the front and rear faces of the body; ports may be used as additional regulated ports or for pressure gauges.
- models supplied without gauge use a GC230 gauge
- maximum operating conditions:
300 PSIG (20.7 bar) and 32°F to 150°F (0°C to 66°C)

Size	Flow (SCFM)	With Gauge		Without Gauge	
		Part #	Price/E	Part #	Price/E
1/4"	82	R18-02RG	\$97.20	R18-02R	\$76.50
3/8"	97	R18-03RG	97.20	R18-03R	76.50
1/2"	97	R18-04RG	97.20	R18-04R	76.50



See pages G-85 to G-89 for accessories.

FRL's are designed for air service only, unless otherwise indicated.

SCFM ratings at 100 PSIG inlet pressure.

Wilkerson Standard Regulators R26

**Features:**

- 0-125 PSI adjusting range
- non-rising push/pull locking adjustment knob
- panel mount nut standard
- excellent flow characteristics
- can be installed with the adjusting knob in any position
- To increase regulated pressure, pull adjusting knob up and turn clockwise. To reduce pressure, turn knob counter clockwise.
- two 1/4" NPT gauge ports standard on models without gauge, one 1/4" NPT gauge port standard on models with gauge - can be used for additional outlet ports
- models supplied without gauge use a GC230 gauge
- maximum operating conditions:
300 PSIG (20.7 bar) and 32°F to 150°F (0°C to 66°C)

Size	Flow (SCFM)	With Gauge		Without Gauge	
		Part #	Price/E	Part #	Price/E
1/4"	112	R26-02RG	\$181.85	R26-02R	\$161.15
3/8"	148	R26-03RG	181.85	R26-03R	161.15
1/2"	185	R26-04RG	181.85	R26-04R	161.15

Wilkerson High Pressure Compact Regulators R26

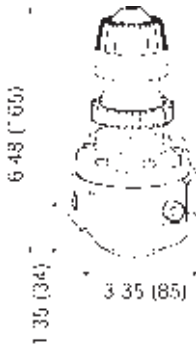
**Features:**

- 0-250 PSI adjusting range
- self-relieving standard
- non-rising push/pull locking adjustment knob
- panel mount nut standard
- excellent flow characteristics
- can be installed with the adjusting knob in any position
- two 1/4" NPT gauge ports standard on models without gauge, one 1/4" NPT gauge port standard on models with gauge can be used for additional outlet ports
- models supplied without gauge use a GC240 gauge
- maximum operating conditions: **300 PSIG (20.7 bar) and 32°F to 150°F (0°C to 66°C)**

Size	Flow (SCFM)	With Gauge		Without Gauge	
		Part #	Price/E	Part #	Price/E
1/4"	112	R26-02RHG	\$181.85	R26-02RH	\$161.15
3/8"	148	R26-03RHG	181.85	R26-03RH	161.15
1/2"	185	R26-04RHG	181.85	R26-04RH	161.15

See pages G-85 to G-89 for accessories.

 FRL's are designed for air service only, unless otherwise indicated.

SCFM ratings at 100 PSIG inlet pressure.

Wilkerson Standard Regulators R28

Features:

- 0-125 PSI adjusting range
- self-relieving standard
- four adjusting pressure ranges available
- To increase regulated pressure, pull adjusting knob up and turn clockwise. To reduce pressure, turn knob counter clockwise.
- Two 1/4" NPT gauge ports located on the front and rear faces of the body; ports may be used as additional regulated ports or for pressure gauges.
- models supplied without gauge use a GC230 gauge
- maximum operating conditions:
300 PSIG (20.7 bar) and 32°F to 150°F (0°C to 66°C)

Size	Flow (SCFM)	With Gauge		Without Gauge	
		Part #	Price/E	Part #	Price/E
3/8"	162	R28-03RG	\$139.55	R28-03R	\$118.85
1/2"	170	R28-04RG	139.55	R28-04R	118.85
3/4"	176	R28-06RG	139.55	R28-06R	118.85



Pneumatic Fittings

Wilkerson High Flow Regulators R30

Features:

- 0-125 PSI adjusting range
- self-relieving standard
- piston operated
- can be installed with the adjusting knob in any position
- To increase regulated pressure, pull adjusting knob up and turn clockwise. To reduce pressure, turn knob counter clockwise.
- two 1/4" NPT gauge ports standard on models without gauge, one 1/4" NPT gauge port standard on models with gauge - can be used for additional outlet ports
- models supplied without gauge use a GC230 gauge
- maximum operating conditions:
300 PSIG (20.7 bar) and 32°F to 150°F (0°C to 66°C)

Size	Flow (SCFM)	With Gauge		Without Gauge	
		Part #	Price/E	Part #	Price/E
3/4"	480	R30-06RG	\$290.00	R30-06R	\$269.30
1"	500	R30-08RG	290.00	R30-08R	269.30



Wilkerson High Pressure High Flow Regulators R30

Features:

- 0-180 PSI adjusting range
- self-relieving standard
- piston operated
- can be installed with the adjusting knob in any position
- To increase regulated pressure, pull adjusting knob up and turn clockwise. To reduce pressure, turn knob counter clockwise.
- two 1/4" NPT gauge ports standard on models without gauge, one 1/4" NPT gauge port standard on models with gauge - can be used for additional outlet ports
- models supplied without gauge use a GC240 gauge
- maximum operating conditions:
300 PSIG (20.7 bar) and 32°F to 150°F (0°C to 66°C)

Size	Flow (SCFM)	With Gauge		Without Gauge	
		Part #	Price/E	Part #	Price/E
3/4"	480	R30-06RHG	\$290.00	R30-06RH	\$269.30
1"	500	R30-08RHG	290.00	R30-08RH	269.30

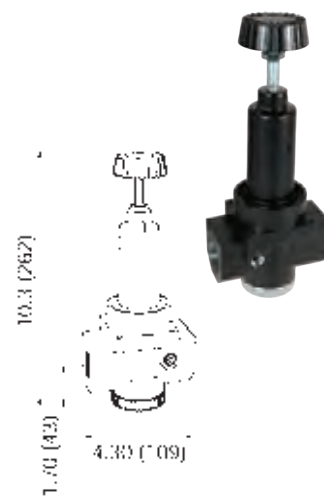

See pages G-85 to G-89 for accessories.

FRL's are designed for air service only, unless otherwise indicated.

SCFM ratings at 100 PSIG inlet pressure.



Wilkerson High Flow Regulators R40

Features:

- 0-125 PSI adjusting range
- self-relieving standard
- piston operated
- can be installed with the adjusting knob in any position
- To increase regulated pressure, pull adjusting knob up and turn clockwise. To reduce pressure, turn knob counter clockwise.
- two ¼" NPT gauge ports standard on models without gauge, one ¼" NPT gauge port standard on models with gauge - can be used for additional outlet ports
- models supplied without gauge use a GC230 gauge
- maximum operating conditions:
300 PSIG (20.7 bar) and 32°F to 150°F (0°C to 66°C)

Size	Flow (SCFM)	With Gauge		Without Gauge	
		Part #	Price/E	Part #	Price/E
1½"	1200	R40-0BRG	\$532.25	R40-0BR	\$511.55
2"	1200	R40-0CRG	532.25	R40-0CR	511.55

Wilkerson High Pressure High Flow Regulators R40



Features:

- 0-180 PSI adjusting range
- self-relieving standard
- piston operated
- can be installed with the adjusting knob in any position
- To increase regulated pressure, pull adjusting knob up and turn clockwise. To reduce pressure, turn knob counter clockwise.
- two ¼" NPT gauge ports standard on models without gauge, one ¼" NPT gauge port standard on models with gauge - can be used for additional outlet ports
- models supplied without gauge use a GC240 gauge
- maximum operating conditions:
300 PSIG (20.7 bar) and 32°F to 150°F (0°C to 66°C)

Size	Flow (SCFM)	With Gauge		Without Gauge	
		Part #	Price/E	Part #	Price/E
1½"	1200	R40-0BRHG	\$532.25	R40-0BRH	\$511.55
2"	1200	R40-0CRHG	532.25	R40-0CRH	511.55

See pages G-85 to G-89 for accessories.



FRL's are designed for air service only, unless otherwise indicated.

SCFM ratings at 100 PSIG inlet pressure.

Wilkerson Compact Filter / Regulators CB6

Over-under units are space savers and provide for installation in tight areas. One common inlet/outlet for both filter and regulator saves on piping costs.

Features:

- 0-125 PSIG adjusting range
- 5 micron reusable element
- 5 oz. bowl
- self-relieving standard
- diaphragm operated
- quick-disconnect bowl guard with integral plastic bowl and safety latch standard
- Two 1/4" gauge ports are provided in either side of the regulator body for installation of a gauge or to use as an additional outlet port. Plug unused port(s).
- supplied with GC230 gauge
- maximum operating conditions:
 - transparent bowl: **150 PSIG** (10.3 bar) and **32°F to 125°F (0°C to 52°C)**
 - metal bowl: **200 PSIG** (13.8 bar) and **32°F to 150°F (0°C to 66°C)**



with guard

3 00 (76)



Size	Flow (SCFM)	With Transparent Bowl and Guard				With Metal Bowl with Sight Glass			
		Automatic Drain		Manual Drain		Automatic Drain		Manual Drain	
		Part #	Price/E	Part #	Price/E	Part #	Price/E	Part #	Price/E
1/4"	64.0	CB6-02AG	\$298.25	CB6-02MG	\$238.00	CB6-02AGMB	\$316.35	CB6-02MGMB	\$256.10
3/8"	70.0	CB6-03AG	298.25	CB6-03MG	238.00	CB6-03AGMB	316.35	CB6-03MGMB	256.10
1/2"	70.0	CB6-04AG	298.25	CB6-04MG	238.00	CB6-04AGMB	316.35	CB6-04MGMB	256.10

Wilkerson Compact Filter / Regulators B18

Features:

- 5-125 PSIG adjusting range for transparent bowl with guard
- 10-250 PSIG adjusting range for metal bowl with sight glass
- 5 micron element
- 4 oz. bowl
- self-relieving standard
- spring-loaded diaphragm
- To increase regulated pressure, pull adjusting knob and turn clockwise. To reduce pressure, turn knob counter clockwise. To lock knob, push down.
- Two 1/4" gauge ports located on the front and rear faces of the body. These ports may be used as additional regulated ports or for pressure gauges. Plug unused port(s).
- supplied with GC230 gauge
- maximum operating conditions:
 - transparent bowl: **150 PSIG** (10.3 bar) and **32°F to 125°F (0°C to 52°C)**
 - metal bowl: **250 PSIG** (17.2 bar) and **32°F to 150°F (0°C to 66°C)**



with metal bowl

2 38 (60)

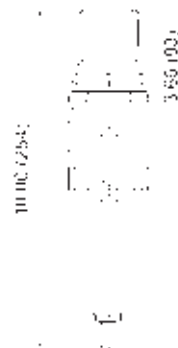

Size	Flow (SCFM)	With Transparent Bowl and Guard				With Metal Bowl with Sight Glass			
		Automatic Drain		Manual Drain		Automatic Drain		Manual Drain	
		Part #	Price/E	Part #	Price/E	Part #	Price/E	Part #	Price/E
1/4"	88	B18-02AG	\$249.80	B18-02MG	\$188.35	B18-02AGMB	\$253.95	B18-02MGMB	\$192.55
3/8"	117	B18-03AG	249.80	B18-03MG	188.35	B18-03AGMB	253.95	B18-03MGMB	192.55
1/2"	121	B18-04AG	249.80	B18-04MG	188.35	B18-04AGMB	253.95	B18-04MGMB	192.55

See pages G-85 to G-89 for accessories.



FRL's are designed for air service only, unless otherwise indicated.

SCFM ratings at 100 PSIG inlet pressure.



Wilkerson Standard Filters/Regulators B28

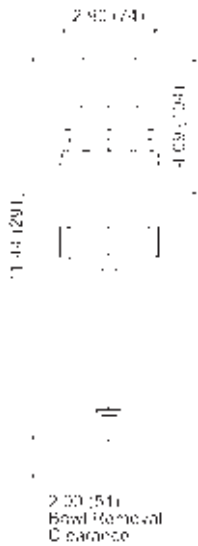

with transparent bowl

**Features:**

- 5-125 PSIG adjusting range for transparent bowl with guard
- 10-250 PSIG adjusting range for metal bowl with sight glass
- 5 micron element
- 6 oz. bowl
- self-relieving standard
- spring-loaded diaphragm
- To increase regulated pressure, pull adjusting knob and turn clockwise. To reduce pressure, turn knob counter clockwise. To lock knob, push down.
- Two 1/4" gauge ports located on the front and rear faces of the body. These ports may be used as additional regulated ports or for pressure gauges. Plug unused port(s).
- supplied with GC230 gauge
- maximum operating conditions:
 - transparent bowl: **150 PSIG** (10.3 bar) and **32°F to 125°F (0°C to 52°C)**
 - metal bowl: **250 PSIG** (17.2 bar) and **32°F to 150°F (0°C to 66°C)**

Size	Flow (SCFM)	With Transparent Bowl and Guard				With Metal Bowl with Sight Glass			
		Automatic Drain		Manual Drain		Automatic Drain		Manual Drain	
		Part #	Price/E	Part #	Price/E	Part #	Price/E	Part #	Price/E
3/8"	140	B28-03AG	\$288.50	B28-03MG	\$227.20	B28-03AGMB	\$293.45	B28-03MGMB	\$232.10
1/2"	165	B28-04AG	288.50	B28-04MG	227.20	B28-04AGMB	293.45	B28-04MGMB	232.10
3/4"	175	B28-06AG	288.50	B28-06MG	227.20	B28-06AGMB	293.45	B28-06MGMB	232.10

See pages G-85 to G-89 for accessories.
SCFM ratings at 100 PSIG inlet pressure.

Wilkerson EconOmist® Compact Lubricators L16



transparent bowl with guard

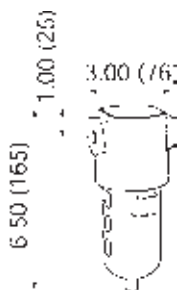

Designed so that all the oil flow observed in the sight dome is broken into a mist and delivered via the airflow to the application. The oil in the bowl can be filled or replenished without interrupting airflow or bleeding pressure from the system. Once the oil-fill cap is removed, the bowl is depressurized and isolated from line pressure, and the bowl itself can then be removed for faster refill, if desired. The bowl can be filled right to the top.

Features:

- 5 oz. bowl
- full view sight dome
- fill under pressure design
- maximum operating conditions:
 - transparent bowl: **150 PSIG** (10.3 bar) and **32°F to 125°F (0°C to 52°C)**
 - metal bowl: **200 PSIG** (13.8 bar) and **32°F to 150°F (0°C to 66°C)**

Size	Flow (SCFM)	With Transparent Bowl		With Metal Bowl	
		Part #	Price/E	Part #	Price/E
1/4"	36.1	L16-02A	\$159.25	L16-02AMB	\$177.30
3/8"	58.5	L16-03A	159.25	L16-03AMB	177.30
1/2"	64.0	L16-04A	159.25	L16-04AMB	177.30

See pages G-85 to G-89 for accessories.
See page G-51 for air tool lubricant.

! FRL's are designed for air service only, unless otherwise indicated.

SCFM ratings at 150 PSIG inlet pressure.

Flow Guide®

The elastomer disc-shaped device is located in the throat of all Wilkerson lubricators and automatically maintains a constant ratio of oil flow to airflow regardless of changing rates of airflow. This allows one lubricator to serve several pneumatic components operating together or intermittently.

Type of oil to use:

For all Wilkerson lubricators, use any petroleum-base, non-detergent light weight oil (SAE 10/150SSU) which will readily break up into a mist, i.e., Mobil DTE light or comparable oil. Do not use synthetic oil or any oils containing additives or solvents. See page G-51 for air tool lubricants.

Wilkerson EconOmist® Compact Lubricators L18

Features:

- 4.09 oz. bowl
- manual drain
- high flow capacity
- can be filled under pressure
- To adjust and set oil delivery rate the unit must be pressurized and air must be flowing through the unit. Turn the sight dome, located on the top of the unit, counter clockwise to initiate oil delivery. The rate of oil delivery depends on air flow rate. If flow increases or decreases, the oil delivery rate will increase or decrease proportionally. Turning the sight dome clockwise will stop all oil delivery.
- maximum operating conditions:
 - transparent bowl: **150 PSIG** (10.3 bar) and **32°F to 125°F (0°C to 52°C)**
 - metal bowl: **250 PSIG** (17.2 bar) and **32°F to 150°F (0°C to 66°C)**

Size	Flow (SCFM)	With Transparent Bowl		With Metal Bowl	
		Part #	Price/E	Part #	Price/E
¼"	88	L18-02A	\$121.05	L18-02AMB	\$132.15
⅜"	90	L18-03A	121.05	L18-03AMB	132.15
½"	96	L18-04A	121.05	L18-04AMB	132.15



Wilkerson EconOmist® Standard Lubricators L26

Features:

- 10 oz. bowl
- adjustable oil feed
- can be filled under pressure
- quick-disconnect metal bowl guard with integral safety latch
- siphon tube filter provides clean lubricant downstream
- The rate of oil delivery may be controlled by turning the adjusting screw counter clockwise for more and clockwise for less oil delivery. If flow increases or decreases, the oil delivery rate will increase or decrease proportionally.
- maximum operating conditions:
 - transparent bowl: **150 PSIG** (10.3 bar) and **32°F to 125°F (0°C to 52°C)**
 - metal bowl: **200 PSIG** (13.8 bar) and **32°F to 150°F (0°C to 66°C)**

Size	Flow (SCFM)	With Transparent Bowl		With Metal Bowl ¹	
		Part #	Price/E	Part #	Price/E
¼"	35	L26-02A	\$195.05	L26-02AMB	\$215.00
⅜"	60	L26-03A	195.05	L26-03AMB	215.00
½"	128	L26-04A	195.05	L26-04AMB	215.00



¹ metal bowl has sight gauge with brass petcock drain

See pages G-85 to G-89 for accessories.

See page G-51 for air tool lubricant.

FRL's are designed for air service only, unless otherwise indicated.

SCFM ratings at 150 PSIG inlet pressure.

Wilkerson EconOmist® Standard Lubricators L28



with metal bowl

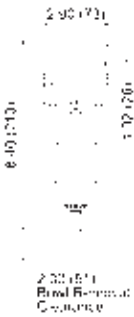

Features:

- 6.11 oz. bowl
- manual drain
- high flow capacity
- can be filled under pressure
- To adjust and set oil delivery rate the unit must be pressurized and air must be flowing through the unit. Turn the sight dome, located on the top of the unit, counter clockwise to initiate oil delivery. If flow increases or decreases, the oil delivery rate will increase or decrease proportionally. Turning the sight dome clockwise will stop all oil delivery.
- maximum operating conditions:
 - transparent bowl: **150 PSIG** (10.3 bar) and **32°F to 125°F (0°C to 52°C)**
 - metal bowl: **250 PSIG** (17.2 bar) and **32°F to 150°F (0°C to 66°C)**

Size	Flow (SCFM)	With Transparent Bowl		With Metal Bowl	
		Part #	Price/E	Part #	Price/E
3/8"	176	L28-03A	\$148.10	L28-03AMB	\$159.30
1/2"	184	L28-04A	148.10	L28-04AMB	159.30
3/4"	200	L28-06A	148.10	L28-06AMB	159.30

SCFM ratings at 150 PSIG inlet pressure.

Wilkerson EconOmist® Standard Lubricators L30



with metal bowl



Features:

- 26 oz. bowl
- transparent bowl: no drain
metal bowl: manual brass petcock drain
- can be filled under pressure
- The rate of oil delivery may be controlled by turning the adjusting screw counter clockwise for more and clockwise for less oil delivery. The oil delivery rate will change automatically to deliver more oil during higher air flows and less oil for air flows lower than the one at which the setting was made.
- maximum operating conditions:
 - transparent bowl: **150 PSIG** (10.3 bar) and **32°F to 125°F (0°C to 52°C)**
 - metal bowl: **200 PSIG** (13.8 bar) and **32°F to 150°F (0°C to 66°C)**

Size	Flow (SCFM)	With Transparent Bowl		With Metal Bowl	
		Part #	Price/E	Part #	Price/E
3/4"	196	L30-06A	\$301.30	L30-06AMB	\$360.50
1"	374	L30-08A	301.30	L30-08AMB	360.50

SCFM ratings at 120 PSIG inlet pressure.

See pages G-85 to G-89 for accessories.
See page G-51 for air tool lubricant.

 FRL's are designed for air service only, unless otherwise indicated.

Wilkerson EconOmist® Standard Lubricators L40 & L50

Features:

- 26 oz. bowl
- transparent bowl: solid bottom
metal bowl: manual drain with sight glass
- full view sight dome
- adjustable oil feed
- can be filled under pressure
- quick-disconnect clamp ring for easy bowl removal
- The rate of oil delivery may be controlled by turning the adjusting screw counter clockwise for more and clockwise for less oil delivery. The oil delivery rate will change automatically to deliver more oil during higher air flows and less oil for air flows lower than the one at which the setting was made.
- maximum operating conditions:
 - transparent bowl: **150 PSIG** (10.3 bar) and **32°F to 125°F (0°C to 52°C)**
 - metal bowl: **200 PSIG** (13.8 bar) and **32°F to 150°F (0°C to 66°C)**



transparent bowl with guard



illustration represents L40 series

Size	Flow (SCFM)	With Transparent Bowl		With Metal Bowl with Sight Glass	
		Part #	Price/E	Part #	Price/E
1½"	927	L40-0BA	\$681.15	L40-0BAMB	\$740.70
2"	1186	L50-0CA	924.00	L50-0CAMB	983.20

See pages G-85 to G-89 for accessories.
See page G-51 for air tool lubricant.

FRL's are designed for air service only, unless otherwise indicated.
SCFM ratings at 120 PSIG inlet pressure.

Wilkerson Compact Combination Units C16

Features:

- maximum operating conditions:
 - transparent bowl: **150 PSIG** (10.3 bar) and **32°F to 125°F (0°C to 52°C)**
 - metal bowl: **200 PSIG** (13.8 bar) and **32°F to 175°F (0°C to 80°C)**
- Included components:
 - (2) modular sleeves
 - (2) mounting brackets (sleeve and bracket)
 - (2) end blocks

Filter series F16:

- 5 micron element
- 5 oz. bowl

Regulator series R16:

- 0-125 PSI adjusting range
- self-relieving
- supplied with a GC230 gauge

Lubricator series L16:

- 5 oz. bowl
- adjustable oil feed
- full view sight dome



transparent bowl with guard



Size	Flow (SCFM)	With Transparent Bowl and Guard				With Metal Bowl with Sight Glass			
		Automatic Drain		Manual Drain		Automatic Drain		Manual Drain	
		Part #	Price/E	Part #	Price/E	Part #	Price/E	Part #	Price/E
¼"	36.1	C16-02A	\$653.05	C16-02M	\$593.00	C16-02AMB	\$689.15	C16-02MMB	\$629.10
⅜"	58.5	C16-03A	653.05	C16-03M	593.00	C16-03AMB	689.15	C16-03MMB	629.10
½"	64.0	C16-04A	653.05	C16-04M	593.00	C16-04AMB	689.15	C16-04MMB	629.10

FRL's are designed for air service only, unless otherwise indicated.
SCFM ratings at 150 PSIG inlet pressure.

Wilkinson Compact Combination Units C18



with metal bowl

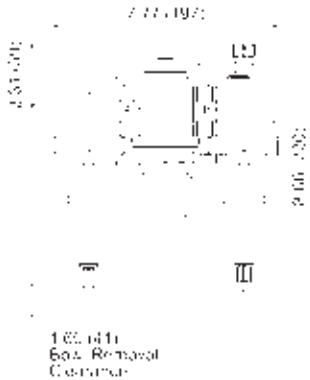

Features:

- maximum operating conditions:
 - transparent bowl: **150 PSIG** (10.3 bar) and **32°F to 125°F (0°C to 52°C)**
 - metal bowl: **250 PSIG** (17.2 bar) and **32°F to 150°F (0°C to 66°C)**
- Included components:
 - (2) end blocks
 - (2) mounting brackets with joiner set and port O-ring

Filter series F18:

- 5 micron element
- 4 oz. bowl

Regulator series R18:

- 0-125 PSI adjusting range
- self-relieving
- supplied with a GC230 gauge

Lubricator series L18:

- 4.09 oz. bowl
- adjustable oil feed
- full view sight dome

Size	Flow (SCFM)	With Transparent Bowl and Guard				With Metal Bowl with Sight Glass			
		Automatic Drain		Manual Drain		Automatic Drain		Manual Drain	
		Part #	Price/E	Part #	Price/E	Part #	Price/E	Part #	Price/E
1/4"	110	C18-02A	\$554.80	C18-02M	\$494.70	C18-02AMB	\$572.20	C18-02MMB	\$518.00
3/8"	160	C18-03A	554.80	C18-03M	494.70	C18-03AMB	572.20	C18-03MMB	518.00
1/2"	160	C18-04A	554.80	C18-04M	494.70	C18-04AMB	572.20	C18-04MMB	518.00

Wilkinson Standard Combination Units C26



with metal bowl

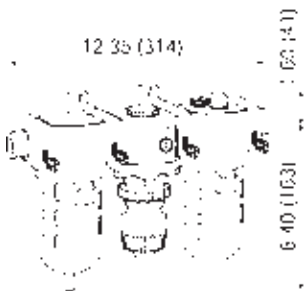

Features:

- maximum operating conditions:
 - transparent bowl: **150 PSIG** (10.3 bar) and **32°F to 125°F (0°C to 52°C)**
 - metal bowl: **200 PSIG** (13.8 bar) and **32°F to 175°F (0°C to 80°C)**
- Included components:
 - (2) modular sleeves
 - (2) mounting brackets (sleeve and bracket)
 - (2) end blocks

Filter series F26:

- 5 micron element
- 10 oz. bowl

Regulator series R26:

- 0-125 PSI adjusting range
- self-relieving
- supplied with a GC230 gauge

Lubricator series L26:

- 10 oz. bowl
- adjustable oil feed
- full view sight dome

Size	Flow (SCFM)	With Transparent Bowl and Guard				With Metal Bowl			
		Automatic Drain		Manual Drain		Automatic Drain		Manual Drain	
		Part #	Price/E	Part #	Price/E	Part #	Price/E	Part #	Price/E
1/4"	35	C26-02A	\$791.25	C26-02M	\$731.15	C26-02AMB	\$831.15	C26-02MMB	\$770.80
3/8"	60	C26-03A	791.25	C26-03M	731.15	C26-03AMB	831.15	C26-03MMB	770.80
1/2"	128	C26-04A	791.25	C26-04M	731.15	C26-04AMB	831.15	C26-04MMB	770.80

! FRL's are designed for air service only, unless otherwise indicated.

SCFM ratings at 150 PSIG inlet pressure.

Wilkerson Standard Combination Units C28

Features:

- modern design and appearance
- quick disconnect bowl / bowl guard
- maximum operating conditions:
 - transparent bowl: **150 PSIG** (10.3 bar) and **32°F to 150°F (0°C to 65.5°C)**
 - metal bowl: **250 PSIG** (17.2 bar) and **32°F to 150°F (0°C to 66°C)**
- Included components:
 - (2) end blocks
 - (2) mounting brackets with joiner set and port O-ring

Filter series F28:

- 5 micron element
- 6 oz. bowl

Regulator series R28:

- 0-125 PSI adjusting range
- self-relieving
- supplied with a GC230 gauge

Lubricator series L28:

- 6.11 oz. bowl
- adjustable oil feed
- full view sight dome



with metal bowl

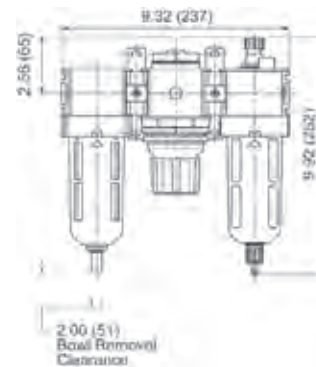

Size	Flow (SCFM)	With Transparent Bowl and Guard				With Metal Bowl			
		Automatic Drain		Manual Drain		Automatic Drain		Manual Drain	
		Part #	Price/E	Part #	Price/E	Part #	Price/E	Part #	Price/E
3/8"	150	C28-03A	\$661.60	C28-03M	\$601.25	C28-03AMB	\$678.80	C28-03MMB	\$624.60
1/2"	175	C28-04A	661.60	C28-04M	601.25	C28-04AMB	678.80	C28-04MMB	624.60
3/4"	175	C28-06A	661.60	C28-06M	601.25	C28-06AMB	678.80	C28-06MMB	624.60

SCFM ratings given at 150 PSIG inlet pressure.

Pneumatic Fittings

Wilkerson Jumbo Combination Units C31

Features:

- high flow capacity
- large bowl reservoir
- maximum operating conditions:
 - transparent bowl: **150 PSIG** (10.3 bar) and **32°F to 125°F (0°C to 52°C)**
 - metal bowl: **200 PSIG** (13.8 bar) and **32°F to 175°F (0°C to 80°C)**
- Included components:
 - (2) brass hex nipples

Filter series F30:

- 5 micron element
- 1 qt. bowl

Regulator series R30:

- 0-125 PSI adjusting range
- self-relieving
- supplied with a GC230 gauge

Lubricator series L30:

- 26 oz. bowl
- adjustable oil feed
- full view sight dome



with metal bowl

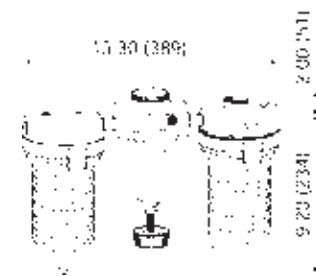

Size	Flow (SCFM)	With Transparent Bowl and Guard				With Metal Bowl with Sight Glass			
		Automatic Drain		Manual Drain		Automatic Drain		Manual Drain	
		Part #	Price/E	Part #	Price/E	Part #	Price/E	Part #	Price/E
3/4"	374	C31-06A	\$1011.50	C31-06M	\$951.40	C31-06AMB	\$1130.25	C31-06MMB	\$1069.90
1"	374	C31-08A	1003.50	C31-08M	943.40	C31-08AMB	1122.25	C31-08MMB	1061.90



FRL's are designed for air service only, unless otherwise indicated.

SCFM ratings given at 120 PSIG inlet pressure.

Wilkerson Combination Units D18



with transparent bowl and guard

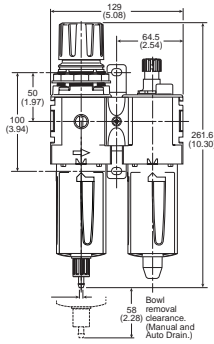

Features:

- light weight, Ready-to-Mount assembly comes standard with pressure gauge and modular T-Bracket/Joiner Assembly
- components integrated into single unit
- modern design and appearance
- quick disconnect bowl / bowl guard
- maximum operating conditions:
 - transparent bowl: **150 PSIG** (10.3 bar) and **32°F to 125°F (0°C to 52°C)**
 - metal bowl: **250 PSIG** (17.2 bar) and **32°F to 150°F (0°C to 66°C)**
- 5 micron element
- 4.09 oz. bowl/lubricator

Regulator

- 0-125 PSI adjusting range
- self-relieving
- supplied with gauge
- 1.72 oz. bowl/filter

Size	Flow (SCFM)	With Transparent Bowl and Guard		With Metal Bowl / Sight Gauge	
		Manual Drain		Manual Drain	
		Part #	Price/E	Part #	Price/E
1/2"	150	D18-04M	\$331.30	D18-04MMB	\$339.25

SCFM ratings at 150 PSIG inlet pressure.

Wilkerson Combination Units D28



with metal bowl

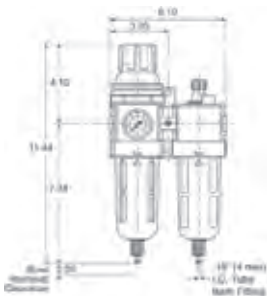

Features:

- light weight, Ready-to-Mount assembly comes standard with pressure gauge and modular T-Bracket/Joiner Assembly
- components integrated into single unit
- modern design and appearance
- quick disconnect bowl / bowl guard
- maximum operating conditions:
 - **250 PSIG** (17.2 bar) and **32°F to 150°F (0°C to 66°C)**
- 5 micron element
- 6.11 oz. bowl/lubricator

Regulator

- 0-125 PSI adjusting range
- self-relieving
- supplied with gauge
- 2.87 oz. bowl/filter

Size	Flow (SCFM)	With Metal Bowl / Sight Gauge	
		Manual Drain	
		Part #	Price/E
1/2"	110	D28-04MMB	\$406.15
3/4"	175	D28-06MMB	406.15

FRL's are designed for air service only, unless otherwise indicated.

SCFM ratings given at 150 PSIG inlet pressure.

Wilkerson Combination Unit with Protective Frame

Application:

Provides downstream air preparation with protection and convenience.

Features:

Include components:

- C31-08AMB 1" FRL with metal bowls and auto drain filter
- BBLV100 1" brass ball valve and AM12 air king on inlet port
- BBV100DTW 3-way ball valve installed between regulator and lubricator provides option for non-lubricated air
- heavy duty frame protects air prep components
- operating:
 maximum pressure: **250 PSIG**
 temperature range: **40°F to 150°F (4°C to 66°C)**
 flow: 320 SCFM



Size	Part #	Price/E
1"	C31-08FRAME	\$2045.00

Wilkerson Exhaust Muffler

Features:

- The contaminants in the exhaust flow are mechanically separated and twice filtered to 5 micron levels. The clean, muffled exhaust flows out of the unit under the metal hood on top.
- removes oily aerosols from exhaust flows
- one inlet port
- 5 micron element
- quick disconnect clamp ring for easy bowl removal
- manual drain
- operating:
 maximum pressure: **150 PSIG (10.3 bar)**
 temperature range: **32°F to 125°F (0°C to 52°C)**

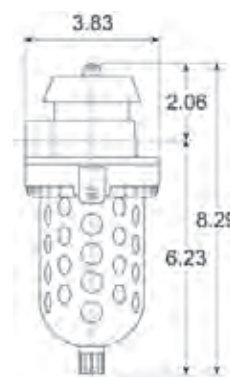

Size	Flow @ 90 PSI	Transparent Bowl with Guard	
		Part #	Price/E
½"	240 SCFM	F23-04M	\$208.70

FRL's are designed for air service only, unless otherwise indicated.



with metal bowl

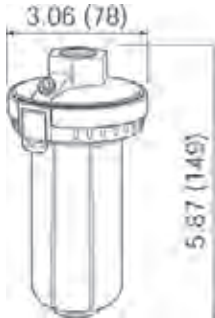

Wilkerson Automatic Drains

As liquid contaminants collect in the bowl, they raise a closed-cell cellular float. When the liquid level reaches a given point, the float triggers a mechanism which pilots line pressure against a large area piston or diaphragm which snaps open the drain valve. The contaminants are discharged from the drain orifice at line pressure. As the liquid level falls, the pilot valve closes, line pressure against the piston/diaphragm returns to atmosphere and the drain valve snaps closed.

Features:

- 5 oz. bowl
- fully automatic, float operated
- full ½" NPT drain inlet
- quick-disconnect clamp ring for easy bowl removal when servicing
- no electrical connections
- easy installation
- maximum operating conditions:
 - transparent bowl: **150 PSIG** (10.3 bar) and **32°F to 125°F (0°C to 52°C)**
 - metal bowl: **200 PSIG** (13.8 bar) and **32°F to 150°F (0°C to 66°C)**

Size	With Transparent Bowl		With Metal Bowl	
	Part #	Price/E	Part #	Price/E
½"	X02-04	\$145.05	X02-04MB	\$160.65

Wilkerson Lockout Valves

Application:

Lockout valves are installed in pneumatic drop legs, or individual pneumatic control lines. In accordance with OSHA procedures, lockout valves are used during maintenance and service procedures of pneumatically (air) operated equipment.

Features:

- used to comply with OSHA 29 CFR part 1910
- built in port for pressure verification to meet ANSI B11 and Pmm155 requirements
- inline or surface mountable
- yellow cast aluminum body with red handle
- pressure range: **15-300 PSI**
- temperature range: **40°F to 175°F (4°C to 79°C)**



Port In/Out	Port Exhaust	Part #	Price/E
½"	¾"	LV4N6D	\$370.10
¾"	¾"	LV6N6D	370.10
¾"	1¼"	LV6NAD	507.75
1"	1¼"	LV8NAD	507.75

Wilkerson Filter Elements

Used On	Description	Part #	Price/E
F03	5 micron element	PS403	\$33.85
F08		FRP-96-729	12.95
F16		FRP-95-160	30.90
F18		FRP-96-639	20.80
F26		FRP-95-115	30.90
F28		FRP-96-653	24.70
F30		FRP-95-209	61.15
F35		FRP-95-505	131.35
F42		FRP-95-566	151.55



FRP-95-115

Wilkerson Coalescing Filter Elements

Used On	Description	Part #	Price/E
M16, M26, M30	type B element (0.5 micron)	MSP-95-989	\$56.80
M16	type C element (0.01 micron)	MTP-95-548	108.95
M26	type C element (0.01 micron)	MTP-95-549	115.30
M30	type C element (0.01 micron)	MTP-95-551	250.40
M35	type C element (0.01 micron)	MTP-95-502	531.50



MTP-95-548

Wilkerson Desiccant Dryer Gel Refill

Used On	Description	Part #	Price/E
X03	8 bags of silica gel refill	DRP-85-059	\$406.95



Wilkerson Bowls with Drain

Used On	Description	Part #	Price/E
F08	plastic bowl with guard and manual drain	GRP-96-712	\$26.25
F16, M16	plastic bowl and metal bowl guard with flex tip drain	FRP-95-014	83.40
	plastic bowl and metal bowl guard with auto drain	FRP-95-015	143.30
	plastic bowl with manual drain	FRP-95-017	56.85
	metal bowl with sight glass and manual drain	GRP-95-133	131.70
	metal bowl with auto drain	FRP-95-950	171.40
F18	plastic bowl and bowl guard with manual drain	GRP-96-634	72.35
	plastic bowl and bowl guard with auto drain	GRP-96-635	125.20
	metal bowl with sight glass and manual drain	GRP-96-636	85.55
F26, M26	plastic bowl and metal bowl guard with flex tip drain	GRP-95-935	98.90
	plastic bowl and metal bowl guard with auto drain	GRP-95-948	201.40
	metal bowl with sight glass and manual drain	GRP-95-931	146.45
	metal bowl with auto drain	GRP-95-960	195.10
F28	plastic bowl, bowl guard, manual drain	GRP-96-642	79.95
	metal bowl, with sight glass, manual drain	GRP-96-644	78.40
F30, M30	plastic bowl and metal bowl guard with manual drain	FRP-95-832	124.90
	plastic bowl and metal bowl guard with auto drain	FRP-95-775	220.25
	plastic bowl with flex tip drain	FRP-96-315	73.60
	metal bowl with sight glass and manual drain	GRP-95-676	330.30
	metal bowl with auto drain	GRP-95-970	238.60



FRP-95-015

Wilkerson Drains



GRP-96-001

Used On	Description	Part #	Price/E
F16, F18, F26, F28, F30, F35, M16, M26, M30, M32, M35	automatic drain with flourocarbon seal	GRP-95-981	\$78.60
F16, F18, F26, F28, F30, M16, M26, M30	automatic float drain with a nitrile seal	GRP-95-973	71.00
F16, F18, F26, F28, F30, F35, M16, M26, M30, M35	manual override drain	GRP-96-001	47.50
F16, F26, F30, M16, M26, M30	manual petcock drain for use with metal bowl units	GRP-95-182	29.30
F16, F26, F30, M16, M26, M30	manual flex tip drain	FRP-95-610	11.00
F18, F28	manual drain	GRP-96-685	17.35

Wilkerson Sight Glass Kit



Used On	Description	Part #	Price/E
M16, M26	sight glass kit for metal bowls	GRP-95-079	\$16.00

Wilkerson Differential Pressure Indicators

Features:

- used to replace damaged indicators on filters and modular coalescing filters
- pressure loss changes color of indicator window from green to red



DP2-01-000

Used On	Description	Part #	Price/E
M16, M26, M30, M32	indicator	DP2-01-000	\$30.00
F35, M35	indicator	DP2-01-001	35.90

Wilkerson Regulator Spring



Used On	Description	Part #	Price/E
R16	0-50 PSI spring	RRP-95-222	\$17.55

Wilkerson Regulator Flush Mounted Gauge



Application:

- for units originally purchased with a flush mounted gauge

Used On	Description	Part #	Price/E
R08	0-160 PSI	GRP-96-719	\$30.00

Wilkerson Ring Style Tamper Resistant Kits



RPA-95-006

Used On	Description	Part #	Price/E
R08	ring style tamper resistant kit	RPA-96-735	\$7.45
R16,R26		RPA-95-006	8.80
R18		RRP-96-671	7.90
R28		RRP-96-672	9.00

Wilkerson Repair Kits

Used On	Description	Part #	Price/E
R16	self-relieving repair kit	RRP-95-131	\$57.90
R18	relieving diaphragm assembly	RRP-96-656	23.40
R26	self-relieving repair kit	RRP-95-952	38.90
R28	relieving diaphragm assembly	RRP-96-986	42.60
R30	valve assembly: valve, spring, bottom plug O-ring	RRP-95-159	47.45
R40	valve assembly: valve, spring, retaining ring O-ring	RRP-95-161	167.45



RRP-95-952

Wilkerson Lubricator Bowls and Bowl Guards

Used On	Description	Part #	Price/E
L08	plastic bowl with guard and manual drain	LRP-96-736	\$31.05
L16	metal bowl with sight glass and manual drain	GRP-95-133	131.70
	plastic bowl with guard and manual drain	GRP-95-019	102.10
	plastic bowl with no drain	LRP-96-937	41.10
L18	metal bowl with sight glass, manual drain	GRP-96-636	85.55
	plastic bowl with guard and manual drain	LRP-96-701	72.40
L26	metal bowl with sight glass and manual drain	GRP-95-931	146.45
	plastic bowl with no drain	LRP-96-938	44.35
L28	metal bowl with sight glass, manual drain	GRP-96-644	78.40
	plastic bowl with guard and manual drain	LRP-96-702	84.80
L30, L40	metal bowl with sight glass and manual drain	GRP-95-676	330.30
L30, L40, L50	plastic bowl with no drain	LRP-96-940	54.70



GRP-95-019

Wilkerson Sight Domes and Fill Plugs

Used On	Description	Part #	Price/E
L08, L16, L26	sight dome kit: dome and O-ring	LRP-95-239	\$16.90
L08	fill plug kit: fill plug and O-ring	LRP-96-730	6.15
L16, L26, L30	fill plug kit: fill plug and O-ring	LRP-95-253	11.30
L18, L28	sight dome assembly (new style)	LRP-96-310	16.60
L30, L40, L50	sight dome kit: dome and O-ring	LRP-95-249	23.15
L40, L50	fill plug kit: fill plug and O-ring	LRP-95-250	35.60



LRP-95-249



Wilkerson Modular Shut-Off Valves

Application:

- Useful for isolating and depressurizing a downstream unit requiring maintenance or replacement.

Features:

- can be installed immediately upstream of a single unit or combination of units
- secure to the unit with a modular sleeve or modular sleeve wall mounting bracket
- ball-type valve operates with a 1/4 turn from open to shut position
- can be locked in the open position
- left to right flow



GPA-95-098

Used On	Description	Part #	Price/E
F16, F26	1/4" NPT safety shut-off valve	GPA-95-096	\$139.95
	3/8" NPT safety shut-off valve	GPA-95-097	139.95
	1/2" NPT safety shut-off valve	GPA-95-098	139.95

Wilkerson Modular Sleeve

Features:

- design easily and quickly connects one or more units and accessories together without pipe nipples
- hand tightening the threaded pin provides a tight seal between the units

Used On	Description	Part #	Price/E
F16, F26	modular sleeve	GPA-95-292	\$17.55

Wilkerson Modular Blocks



GPA-95-919



GPA-95-223



GPA-96-610

Features:
Manifold Block

- flexible installation can be installed after the filter or regulator, providing three additional 1/4" NPT tapped auxiliary ports
- 1/2" inlet/outlet ports non-tapped
- 1-17/32" width

End Block

- When used with the modular sleeve, end blocks allow a single unit or a combination of units to be piped into the air system in the modular mode.
- allows ease of unit servicing or replacement without disturbing the air line connections

Used On	Description	Part #	Price/E
F16, M16, F26, M26	manifold block, three 1/4" NPT auxiliary ports	GPA-95-919	\$52.65
	end block, 1/4" NPT	GPA-95-223	31.70
	end block, 3/8" NPT	GPA-95-224	31.70
	end block, 1/2" NPT	GPA-95-225	31.70
	end block, 1/4" NPT	GPA-96-610	28.65
F18, F28	end block, 3/8" NPT	GPA-96-611	28.65
	end block, 1/2" NPT	GPA-96-612	28.65
	end block, 3/4" NPT	GPA-96-613	28.65

Wilkerson Modular Pipe Adapters

Features:

- When used with the modular sleeve, adapter inserts allow a single unit or a combination of units to be piped into the air system in the modular mode.
- allows ease of unit servicing or replacement without disturbing the air line connections
- set includes 2 blocks



GPA-95-037

Used On	Description	Part #	Price/E
F16, M16, F26, M26	1/4" NPT	GPA-95-035	\$44.85
	3/8" NPT	GPA-95-036	44.85
	1/2" NPT	GPA-95-037	44.85

Wilkerson Mounting Brackets and Joiner Sets

Used On Filter/ Regulator/ Lubricator Series	Description	Part #	Price/E
RB3	mounting bracket (type L) and nut	GRP-95-747	\$18.40
F03	mounting bracket	PS417B	\$19.75
F08	mounting bracket (type T) with joiner set and port O-ring	GPA-96-737	14.45
	mounting bracket (type C)	GPA-97-010	12.25
	joiner set and port O-ring	GPA-96-738	8.80
R08	mounting bracket (type L)	GRP-96-739	10.30
F16, M16	mounting bracket (type L)	GPA-95-016	35.95
R16	mounting bracket (type L) and nut	GPA-95-011	23.75
R16, R21, R26, R30, R40	wall mount bracket with 1/4" NPT gauge port adapter	RRP-95-590	29.05
F18	mounting bracket (type C)	GPA-96-604	24.70
	mounting bracket (type L)	GPA-96-606	16.20
F18, F28	mounting bracket (type T)	GPA-96-602	18.40
	mounting bracket (type T) with joiner set and port O-ring	GPA-96-603	40.25
F26, M26	mounting bracket (type L)	GPA-95-946	43.10
R26	mounting bracket (type C) and nut	RPA-95-947	19.45
F28	mounting bracket (type C)	GPA-96-605	29.05
	mounting bracket (type L)	GPA-96-607	21.45
F30	wall mount, U-bolt pipe clamp	GRP-95-734	24.30



GPA-96-737

Wilkerson Wall Mounts

Features:

- designed to mount a single unit or combination of units directly to the wall
- sleeve and mounting bracket can be ordered assembled, or just the mounting bracket alone for use on existing modular sleeves

Used On	Description	Part #	Price/E
R16, R26	bracket	GPA-95-968	\$15.00
	sleeve and bracket	GPA-95-969	33.45



GPA-95-969

Wilkerson FRL Display

Increase your sales with this heavy duty, point-of-purchase Dixon® FRL Display. Display is designed to highlight the features and benefits of a modular Filter-Regulator-Lubricator Combination Unit for air line services. The display is perfect for a "Will Call" or showroom sales area.

Features:

- FRL combination unit with standard metal bowl with sight glass and manual drain
- modular mounting clamps
- pipe adapters
- display stand
- assembly is required

Part #	Price/E
WILK26DISPLAY	\$969.80





Series 1 FRL Display

Increase your sales with this heavy duty, point-of-purchase Dixon® FRL Display. Display is designed to highlight the features and benefits of a modular Filter-Regulator-Lubricator Combination Unit for air line services. The display is perfect for your "Will Call" or showroom sales area.

Features:

- 74 Series basic combination unit with metal bowl with sight glass and manual drain
- modular mounting clamps
- pipe adapters
- display stand
- assembly is required

Part #	Price/E
NORG74DISPLAY	\$963.45

Series I line of miniature filters, filter/regulators, regulators and lubricators in prepackaged clear plastic units are suitable for hanging on store peg racks or displays. The primary features of each unit are printed on the packaging. Each package contains 1 unit and an instruction sheet.

Series 1 Carded Miniature Filters



Features:

- 5 micron element
- 1 oz. reservoir
- inlet pressure **150 PSI** maximum
- maximum temperature: **125°F (52°C)**
- transparent bowl

Port Size	Flow (SCFM)	Automatic Drain		Manual Drain	
		Part #	Price/E	Part #	Price/E
1/4"	24	F07-200AC	\$75.85	F07-200MC	\$64.60

Series 1 Carded Miniature Regulator

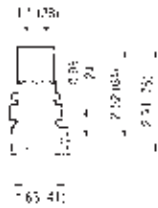

Features:

- pressure range 5-100 PSI
- relieving type
- inlet pressure **250 PSI** maximum
- maximum temperature: **150°F (66°C)**
- supplied with a GC620 gauge

Port Size	Flow (SCFM)	with Gauge	
		Part #	Price/E
1/4"	15	R07-200RGC	\$73.80

Series 1 Carded Miniature Lubricator



Features:

- 1 oz. reservoir
- inlet pressure **150 PSI** maximum
- maximum temperature: **125°F (52°C)**

Port Size	Flow (SCFM)	with Transparent Bowl	
		Part #	Price/E
1/4"	15	L07-200AC	\$92.00

FRL's are designed for air service only, unless otherwise indicated.

SCFM ratings given at 100 PSIG inlet pressure for regulators, 90 PSIG all others.

Series 1 Miniature Filter/Regulators

Features:

- pressure range 5-100 PSI
- relieving type
- 5 micron element
- 1 oz. reservoir
- push to lock adjusting knob
- inlet pressure **150 PSI** maximum
- maximum temperature: **125°F (52°C)**
- supplied with a GC620 gauge
- bowl guard not available
- transparent bowl



Port Size	Flow (SCFM)	Automatic Drain		Manual Drain	
		Part #	Price/E	Part #	Price/E
1/4"	14	B07-202AGC	\$143.10	B07-202MGC	\$129.80

SCFM ratings given at 150 PSIG inlet pressure.

Series 1 Miniature Filters

- 5 micron element
- 1 oz. reservoir
- inlet pressure **150 PSI** maximum
- maximum temperature: **125°F (52°C)**
- transparent bowl

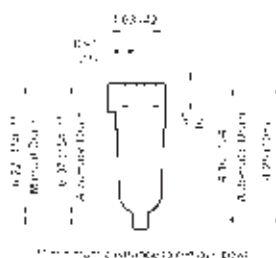

Port Size	Flow (SCFM)	Automatic Drain		Manual Drain	
		Part #	Price/E	Part #	Price/E
1/8"	19	F07-100A	\$73.15	F07-100M	\$62.75
1/4"	24	F07-200A	71.45	F07-200M	61.25

SCFM ratings given at 90 PSIG inlet pressure.

Series 1 Miniature Regulators

- pressure range 5-100 PSI
- relieving type
- inlet pressure **300 PSI** max.
- maximum temperature: **150°F (66°C)**
- regulation at flows up to 22 SCFM at 100 PSIG
- RG models supplied with a GC620 gauge
- panel nut not included



Port Size	Flow (SCFM)	with Gauge		without Gauge	
		Part #	Price/E	Part #	Price/E
1/8"	14	R07-100RG	\$64.20	R07-100R	\$47.50
1/4"	15	R07-200RG	63.80	R07-200R	47.10

SCFM ratings given at 100 PSIG inlet pressure.

Series 1 Miniature Filter/Regulators

- pressure range 5-100 PSI
- relieving type
- 5 micron element
- 1 oz. reservoir
- push to lock adjusting knob
- inlet pressure **150 PSI** maximum
- maximum temperature: **125°F (52°C)**
- supplied with a GC620 gauge
- bowl guard not available
- transparent bowl

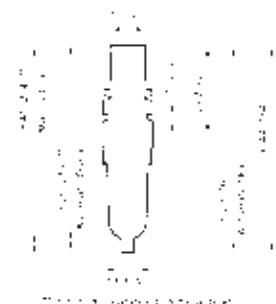

Port Size	Flow (SCFM)	Automatic Drain		Manual Drain	
		Part #	Price/E	Part #	Price/E
1/8"	13	B07-102AG	\$134.75	B07-102MG	\$119.95
1/4"	24	B07-202AG	129.60	B07-202MG	118.60

SCFM ratings given at 150 PSIG inlet pressure.

Series 1 Miniature Lubricators



- 1 oz. reservoir
- inlet pressure **150 PSI** maximum
- maximum temperature: **125°F (52°C)**

Port Size	Flow (SCFM)	Transparent Bowl	
		Part #	Price/E
1/8"	10	L07-100A	\$94.85
1/4"	14	L07-200A	93.45

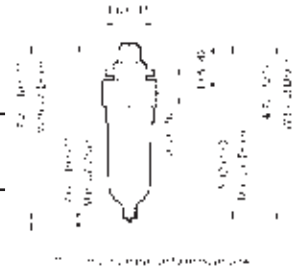

Series 1 Miniature Combination Units



- pressure range 5-125 PSI
- 1 oz. reservoir
- supplied with a GC620 gauge
- inlet pressure **150 PSI** maximum
- maximum temperature: **125°F (52°C)**
- transparent bowl

Port Size	Flow (SCFM)	Automatic Drain		Manual Drain	
		Part #	Price/E	Part #	Price/E
1/8"	10	P1A-100A	\$278.75	P1A-100M	\$268.35
1/4"	14	P1A-200A	274.35	P1A-200M	264.15

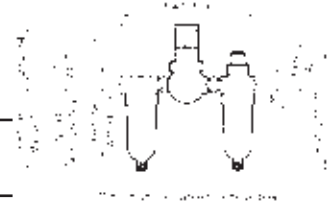

Series 1 Micro Mate Combination Units



- pressure range 5-125 PSI
- requires only 2 pipe connections
- inlet pressure **150 PSI** maximum
- maximum temperature: **125°F (52°C)**
- transparent bowl

Port Size	Flow (SCFM)	Automatic Drain	
		Part #	Price/E
1/8"	10	PTH-100AG	\$249.25
1/4"	14	PTH-200AG	261.90



Series 1 Sub-Compact Airline Filters

Features:

- particle removal per ISO 8573-1, Class 5 and Class 3
- 40 micron element
- 2 oz. reservoir
- quick-release bayonet bowl
- prismatic lens liquid level indicator
- inlet pressure:
 - transparent bowl: **150 PSI** and **125°F (52°C)**
 - metal bowl: **250 PSI** and **150°F (66°)**

Sub-Compact with Transparent Bowl

Port Size	Flow (SCFM)	Semi-Automatic Drain		Manual Drain	
		Part #	Price/E	Part #	Price/E
1/4"	55	F72G-2A	\$142.55	F72G-2M	\$78.20

Sub-Compact with Metal Bowl and Sight Glass

Port Size	Flow (SCFM)	Semi-Automatic Drain		Manual Drain	
		Part #	Price/E	Part #	Price/E
1/4"	55	F72G-2A-MB	159.80	F72G-2M-MB	95.10



! FRL's are designed for air service only, unless otherwise indicated.

SCFM ratings at 100 PSIG inlet pressure for regulators, 90 PSIG all others.

Series 1 Compact Airline Filters

Features:

- particle removal per ISO 8573-1, Class 5 and Class 3
- 40 micron element
- 4 oz. reservoir
- quick-release bayonet bowl
- prismatic lens liquid level indicator
- inlet pressure:
 - transparent bowl: **150 PSI** and **125°F (52°C)**
 - metal bowl: **250 PSI** and **175°F (79°C)**

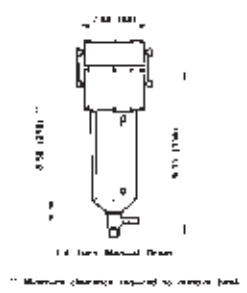
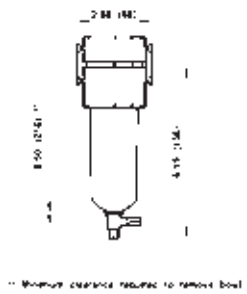

Compact with Transparent Bowl

Port Size	Flow (SCFM)	Automatic Drain		Manual Drain	
		Part #	Price/E	Part #	Price/E
1/4"	53	F73G-2A	\$200.20	F73G-2M	\$121.15
3/8"	65	F73G-3A	200.20	F73G-3M	121.15
1/2"	69	F73G-4A	198.35	F73G-4M	120.60



Compact with Metal Bowl and Sight Glass

Port Size	Flow (SCFM)	Automatic Drain		Manual Drain	
		Part #	Price/E	Part #	Price/E
1/4"	53	F73G-2A-MB	\$210.10	F73G-2M-MB	\$131.00
3/8"	65	F73G-3A-MB	210.10	F73G-3M-MB	131.00
1/2"	69	F73G-4A-MB	210.10	F73G-4M-MB	130.30

Series 1 Standard Airline Filters

Features:

- particle removal per ISO 8573-1, Class 5 and Class 3
- 40 micron element
- 7 oz. reservoir
- quick-release bayonet bowl
- prismatic lens liquid level indicator
- inlet pressure:
 - transparent bowl: **150 PSI** and **125°F (52°C)**
 - metal bowl: **250 PSI** and **175°F (79°C)**

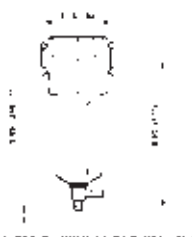
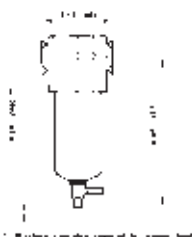

Standard with Transparent Bowl and Guard

Port Size	Flow (SCFM)	Automatic Drain		Manual Drain	
		Part #	Price/E	Part #	Price/E
3/8"	112	F74G-3A	\$254.00	F74G-3M	\$176.00
1/2"	140	F74G-4A	249.15	F74G-4M	173.60
3/4"	140	F74G-6A	251.55	F74G-6M	173.60



Standard with Metal Bowl and Sight Glass

Port Size	Flow (SCFM)	Automatic Drain		Manual Drain	
		Part #	Price/E	Part #	Price/E
3/8"	112	F74G-3A-MB	\$258.90	F74G-3M-MB	\$181.30
1/2"	140	F74G-4A-MB	255.20	F74G-4M-MB	177.85
3/4"	140	F74G-6A-MB	255.20	F74G-6M-MB	178.75

See pages G-106 to G-111 for accessories.

FRL's are designed for air service only, unless otherwise indicated.

SCFM ratings at 90 PSIG inlet pressure.

Series 1 Jumbo Airline Filters



Features:

- general purpose with low pressure drop and excellent water removal characteristics
- 40 micron element
- 1 qt. reservoir
- inlet pressure: **250 PSI** and **175°F (79°C)**

Jumbo with Metal Bowl and Sight Glass

Port Size	Flow (SCFM)	Automatic Drain		Manual Drain	
		Part #	Price/E	Part #	Price/E
3/4"	325	F17-600A	\$462.95	F17-600M	\$380.65
1"	425	F17-800A	456.30	F17-800M	377.00
1 1/4"	425	F17-A00A	529.00	F17-A00M	443.60
1 1/2"	425	F17-B00A	523.95	F17-B00M	450.05

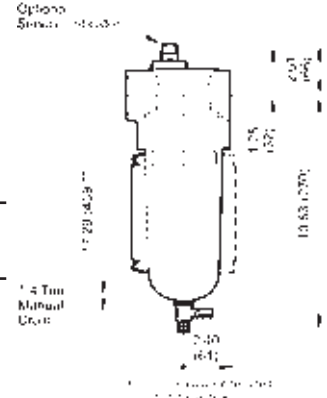

Features:

- 40 micron element
- quick-release bayonet bowl
- prismatic lens liquid level indicator
- 7 oz. reservoir
- inlet pressure: **250 PSI** and **175°F (79°C)**

Jumbo with Metal Bowl and Sight Glass

Port Size	Flow (SCFM)	Automatic Drain		Manual Drain	
		Part #	Price/E	Part #	Price/E
2"	1400	F18-C00A	\$1601.70	F18-C00M	\$1520.90

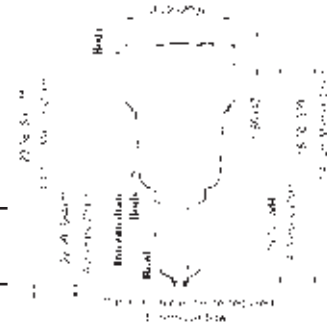

Series 1 Oil Removal (Coalescing) Filters

Features:

- provides air quality class 2 hydrocarbon and class 1 particulate removal per ISO 8573-1
- element removes particles down to 0.01mm. Maximum remaining oil content of air leaving the filter is 0.01 ppm at **70°F (21°C)** with an inlet concentration of 8 ppm
- For maximum service life install a general purpose filter upstream of the oil removal filter.
- service life indicator turns from green to red when element needs to be replaced
- in-line or modular installation
- quick-release bayonet bowl
- prismatic lens liquid level indicator
- inlet pressure: **250 PSI** and **150°F (66°C)**



Port Size	Flow (SCFM) Saturated	SCFM Dry	Automatic Drain	
			Part #	Price/E
3/8"	35	70	F74C-3A-MB	\$419.05
1/2"	35	75	F74C-4A-MB	415.10
1/2"	60	100	F74H-4A-MB	479.10
3/4"	60	120	F74H-6A-MB	474.60

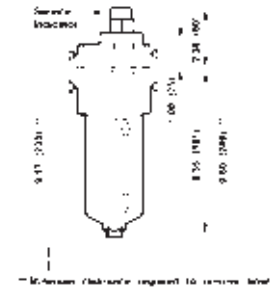

See pages G-106 to G-111 for accessories.

FRL's are designed for air service only, unless otherwise indicated.

SCFM ratings at 90 PSIG inlet pressure.

Series 1 Oil Vapor Removal Filters

Features:

- provides air quality class 1 particulate removal per ISO 8573-1, when used with the F74C series
- Filter and element designs optimizes air velocity and contact time to reduce oil content of air leaving the filter to 0.003 ppm at **70°F (21°C)**.
- For maximum service life install a general purpose filter and an oil removal filter upstream of the oil vapor removal filter.
- Minimum service life of 400 hours can be expected if the vapor removal filter is protected upstream by an oil removal (coalescing) filter and if the filtration temperature is in the region of **70° to 80°F (21° to 26°C)**. Above this range, oil vapor content of compressed air increases substantially and element service life is reduced.
- Carbon cartridge element provides long service life.
- Activated carbon cartridge filter element absorbs oil vapors and removes most hydrocarbon odors.
- in-line or modular installation
- quick-release bayonet bowl
- inlet pressure: **250 PSI and 150°F (66°C)**
- metal bowl

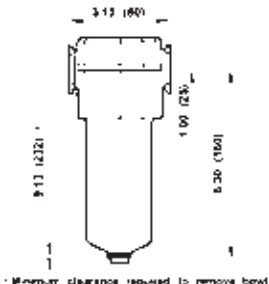

Port Size	Flow (SCFM)	Automatic Drain with Metal Bowl	
		Part #	Price/E
3/8"	21	F74V-3A-MB	\$391.70
1/2"	21	F74V-4A-MB	390.65

SCFM ratings at 90 PSIG inlet pressure.



Series 1 Sub-Compact Regulators

**Features:**

- pressure range 5-150 PSI
- inlet pressure: **300 PSI**
- maximum temperature: **150°F (66°C)**
- in-line or modular installation
- two full flow 1/8" NPT gauge ports
- RG models supplied with GC620 gauge
- To order 0-60 PSI range, add an L to the end of the part number.

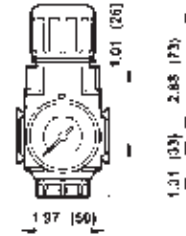

Port Size	Flow (SCFM)	with Gauge		without Gauge	
		Part #	Price/E	Part #	Price/E
1/4"	70	R72G-2RG	\$84.75	R72G-2R	\$68.05
3/8"	70	R72G-3RG	89.30	R72G-3R	72.60

Series 1 Compact Regulators

**Features:**

- pressure range 5-150 PSI
- inlet pressure: **300 PSI**
- maximum temperature: **150°F (66°C)**
- in-line or modular installation
- relieving type
- two full flow 1/4" NPT gauge ports
- RG models supplied with GC230 gauge
- To order 0-60 PSI range, add an L to the end of the part number.

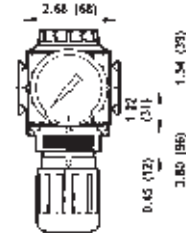

Port Size	Flow (SCFM)	with Gauge		without Gauge	
		Part #	Price/E	Part #	Price/E
1/4"	91	R73G-2RG	\$117.35	R73G-2R	\$96.65
3/8"	144	R73G-3RG	116.85	R73G-3R	96.20
1/2"	144	R73G-4RG	116.40	R73G-4R	95.70

See pages G-106 to G-111 for accessories.

! FRL's are designed for air service only, unless otherwise indicated.

SCFM ratings given at 150 PSIG inlet pressure, 2" unit at 100 PSIG

Series 1 Standard Regulators

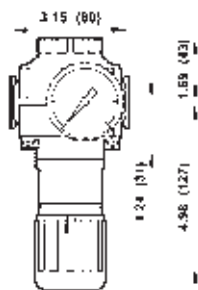

Features:

- pressure range 5-150 PSI
- inlet pressure: **300 PSI**
- maximum temperature: **150°F (66°C)**
- in-line or modular installation
- relieving type
- two full flow 1/4" NPT gauge ports
- RG models supplied with GC230 gauge
- To order 0-60 PSI range, add an L to the end of the part number.



Port Size	Flow (SCFM)	with Gauge		without Gauge	
		Part #	Price/E	Part #	Price/E
3/8"	208	R74G-3RG	\$173.05	R74G-3R	\$152.35
1/2"	220	R74G-4RG	170.10	R74G-4R	149.45
3/4"	220	R74G-6RG	170.90	R74G-6R	150.20

Series 1 Jumbo Regulators

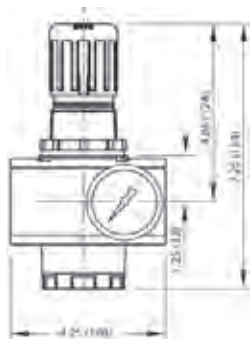

Features:

- pressure range 5-125 PSI
- inlet pressure: **300 PSI**
- maximum temperature: **175°F (79°C)**
- in-line or modular installation
- relieving type
- two full-flow 1/4" NPT gauge ports
- RG models supplied with GC230 gauge



Port Size	Flow (SCFM)	with Gauge		without Gauge	
		Part #	Price/E	Part #	Price/E
3/4"	440	R17-600RG	\$311.40	R17-600R	\$290.70
1"	480	R17-800RG	307.15	R17-800R	286.45
1 1/4"	400	R17-A00RG	374.95	R17-A00R	354.25
1 1/2"	440	R17-B00RG	386.60	R17-B00R	365.90

SCFM ratings given at 150 PSIG inlet pressure, 2" unit at 100 PSIG

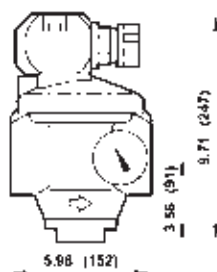

Features:

- 5-125 PSI range
- inlet pressure: **450 PSI**
- maximum temperature: **175°F (79°C)**
- relieving type
- two full flow 1/4" NPT gauge ports
- RG model supplied with GC230 gauge



Port Size	Flow (SCFM)	with Gauge		without Gauge	
		Part #	Price/E	Part #	Price/E
2"	2000	R18-C05RG	\$1889.40	R18-C05R	\$1868.70

SCFM ratings given at 150 PSIG inlet pressure, 2" unit at 100 PSIG

Series 1 General T-Handle Regulators

Floating valve pin provides positive FRL seating and dependability. Large diaphragm provides quick response to flow demands and line pressure changes. Balanced valve reduces inlet pressure variations on outlet pressure.

Features:

- pressure range 5-125 PSI
- inlet pressure: **400 PSI**
- maximum temperature: **175°F (79°)**
- T-handle adjustment
- supplied with GC620 gauge

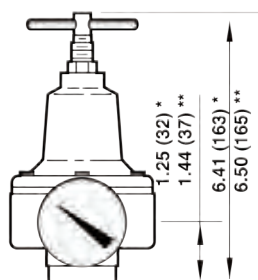

Port Size	Flow (SCFM)	with Gauge	
		Part #	Price/E
1/4"	110	R11-013RG	\$352.20
3/8"	110	R11-037RG	352.20
1/2"	260	R11-061RG	404.05

SCFM ratings at 150 PSIG.



See pages G-106 to G-111 for accessories.

FRL's are designed for air service only, unless otherwise indicated.

Series 1 Manifold Regulators

Manifold up to six regulators on a single air supply. Design allows in-line installation with hex nipple or modular installation with 72 Series accessories.



Features:

- pressure range 5-150 PSI
- inlet pressure: **300 PSI**
- maximum temperature: **150°F (66°C)**
- RG models supplied with GC620 gauge

Port Size	Flow (SCFM)	with Gauge		without Gauge	
		Part #	Price/E	Part #	Price/E
1/4"	83	R72M-2RG	\$161.85	R72M-2R	\$145.15
3/8"	83	R72M-3RG	165.85	R72M-3R	149.15

SCFM ratings at 150 PSIG.

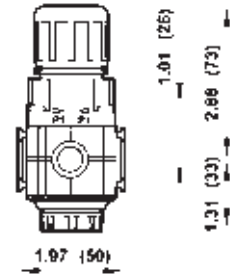

Series 1 Cylinder Gas Regulator

Applications:

UL listed for service with Carbon Dioxide, water, pumped air, Nitrogen, Argon, Helium, Krypton, Neon and Xenon.
Not to be used with flammable gases.

Features:

- pressure range 5-125 PSI
- inlet pressure: **3000 PSI**
- maximum temperature: **140°F (60°C)**
- relieving type
- two ports for high pressure and two ports for service

Port Size	Flow (SCFM)	without Gauge	
		Part #	Price/E
1/4"	10	R83-200R	\$153.70

SCFM ratings given at 1000 PSIG inlet pressure.

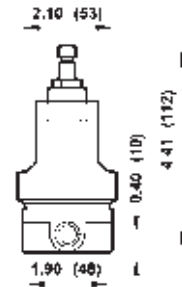

Series 1 Miniature Water Regulator

Application:

Designed for use with deionized water and potable water systems. Plastic and metal components in contact with fluid are approved by the National Sanitation Foundation (NSF) or meet Food and Drug Administration (FDA) recommendations for use in potable water systems.

Features:

- inlet pressure: **150 PSI**
- maximum temperature: **125°F (52°C)**
- non-relieving type
- supplied with GC620 gauge
- food grade elastomers

Port Size	Flow (GPM)	with Gauge	
		Part #	Price/E
1/4"	1.75	R91-221RG	\$89.35

Flow rating at 100 PSIG.

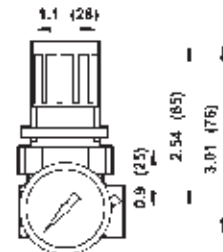

See pages G-106 to G-111 for accessories.

 FRL's are designed for air service only, unless otherwise indicated.

Series 1 Water Pressure Regulators

Application:

Used in water systems to reduce and maintain pressure at a nearly constant level despite changes in the inlet pressure and changes in downstream flow requirements.



Features:

- pressure range 5-125 PSI
- inlet pressure: **400 PSI**
- T-handle adjustment
- brass body and aluminum bonnet
- non-relieving type
- gauge port is full-flow and can be used as an outlet port
- supplied with GC230 gauge
- temperature range:
 - water service: **35° to 200°F (2°C to 93°C)**
 - air service: **-30° to 200°F (-34°C to 93°C)**



Port Size	Flow (GPM)	with Gauge	
		Part #	Price/E
1/4"	5	R43-201RG	\$277.40
3/8"	5	R43-301RG	333.95
1/2"	10	R43-406RG	382.65

Flow ratings given at 150 PSIG inlet pressure.

Series 1 Water Regulators

Application:

Balanced valve minimizes effects of the inlet pressure variations on outlet pressure.

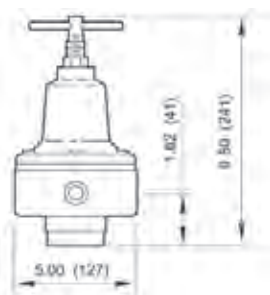

Features:

- inlet pressure: **400 PSI**
- T-handle adjustment
- non-relieving type
- body, valve and bottom plug are brass, bonnet is aluminum and steel
- elastomers are nitrile
- temperature range:
 - water service: **35° to 200°F (2° to 93°C)**
 - air service: **-30° to 200°F (-34° to 93°C)**



Port Size	Flow (GPM)	without Gauge	
		Part #	Price/E
3/4"	27.5	11-009-065	\$1298.10
1"	27.5	11-009-081	1310.45

Flow ratings given at 150 PSIG inlet pressure.

Series 1 Sub-Compact Filter / Regulators



Features:

- particle removal per ISO 8573-1, Class 5 and Class 3
- pressure range 5-150 PSI
- in-line or modular installation
- 40 micron element
- 2 oz. reservoir
- quick-release bayonet bowl
- prismatic lens liquid level indicator
- supplied with GC620 gauge
- inlet pressure:
 - transparent bowl: **150 PSI and 125°F (52°C)**
 - metal bowl: **250 PSI and 150°F(66°C)**



with transparent bowl

Sub-Compact with Transparent Bowl

Port Size	Flow (SCFM)	Semi-Automatic Drain		Manual Drain	
		Part #	Price/E	Part #	Price/E
1/4"	80	B72G-2AG	\$216.85	B72G-2MG	\$150.45

Sub-Compact with Metal Bowl and Sight Glass

Port Size	Flow (SCFM)	Semi-Automatic Drain		Manual Drain	
		Part #	Price/E	Part #	Price/E
1/4"	80	B72G-2AG-MB	\$232.00	B72G-2MG-MB	\$167.45
3/8"		B72G-3AG-MB	236.35	B72G-3MG-MB	171.45



with metal bowl

SCFM ratings given at 150 PSIG inlet pressure.

See pages G-106 to G-111 for accessories.

FRL's are designed for air service only, unless otherwise indicated.

SCFM ratings given at 150 PSIG inlet pressure.

Series 1 Compact Filters/Regulators



with transparent bowl



with metal bowl

Features:

- particle removal per ISO 8573-1, Class 5 and Class 3
- pressure range 5-150 PSI
- in-line or modular installation
- 40 micron element
- 3.5 oz. reservoir
- quick-release bayonet bowl
- prismatic lens liquid level indicator
- supplied with GC230 gauge
- inlet pressure:
 - transparent bowl: **150 PSI and 125°F (52°C)**
 - metal bowl: **250 PSI and 175°F (79°C)**

Compact with Transparent Bowl

Port Size	Flow (SCFM)	Automatic Drain		Manual Drain	
		Part #	Price/E	Part #	Price/E
1/4"	78	B73G-2AG	\$306.30	B73G-2MG	\$228.50
3/8"	123	B73G-3AG	306.30	B73G-3MG	228.50
1/2"	123	B73G-4AG	306.30	B73G-4MG	228.50

Compact with Metal Bowl and Sight Glass

Port Size	Flow (SCFM)	Automatic Drain		Manual Drain	
		Part #	Price/E	Part #	Price/E
1/4"	78	B73G-2AG-MB	\$316.05	B73G-2MG-MB	\$238.35
3/8"	123	B73G-3AG-MB	313.30	B73G-3MG-MB	238.35
1/2"	123	B73G-4AG-MB	316.05	B73G-4MG-MB	235.20

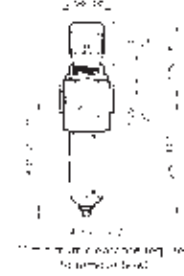

Series 1 Standard Filters/Regulators



with guard



with metal bowl

Features:

- pressure range 5-150 PSI
- 40 micron element
- 7 oz. reservoir
- relieving type
- supplied with GC230 gauge
- inlet pressure:
 - transparent bowl: **5-150 PSI and 125°F (52°C)**
 - metal bowl: **5-150 PSI and 175°F (79°C)**

Standard with Transparent Bowl and Guard

Port Size	Flow (SCFM)	Automatic Drain		Manual Drain	
		Part #	Price/E	Part #	Price/E
1/2"	212	B74G-4AG	\$88.30	B74G-4MG	\$279.30
3/4"	212	B74G-6AG	360.85	B74G-6MG	280.60

Standard with Metal Bowl and Sight Glass

Port Size	Flow (SCFM)	Automatic Drain		Manual Drain	
		Part #	Price/E	Part #	Price/E
3/8"	163	B74G-3AG-MB	\$369.25	B74G-3MG-MB	\$288.10
1/2"	212	B74G-4AG-MB	361.05	B74G-4MG-MB	285.30
3/4"	212	B74G-6AG-MB	396.55	B74G-6MG-MB	285.30



See pages G-106 to G-111 for accessories.

 FRL's are designed for air service only, unless otherwise indicated.

SCFM ratings given at 150 PSIG inlet pressure.

Series 1 Sub-Compact Micro-Fog Lubricators

Application:

- Micro-fog lubricators, identified by a red adjusting screw, are used for applications containing one or more points of lubrication, cylinders and multiple or single tools.
- Air flow through the lubricator lifts oil from the reservoir to the sight-feed dome. Oil is dropped into the fog generator and atomized into a fine mist. Lightweight particles are delivered downstream for lubrication. Heavier particles fall back into the reservoir.
- The micro-fog lubricator delivers 10% of the oil drops visible through the transparent sight-feed dome.
- Micro-fog lubricators cannot be filled under pressure. 

Features:

- 2 oz. reservoir
- in-line or modular installation
- quick release bayonet bowl
- micro-fog design delivers aerosol mist
- recommended lubricants: misting type oil rated 50 to 200 SSU (ISO Grade 7 to 46) at **100°F (38°C)**
- maximum operating conditions:
 - transparent bowl: **150 PSI and 125°F (52°C)**
 - metal bowl: **250 PSI and 175°F (79°C)**

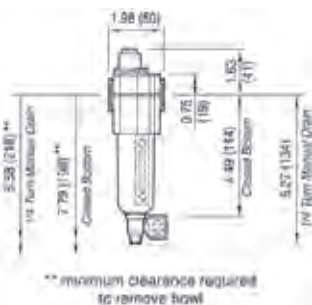

Port Size	Flow (SCFM)	Transparent Bowl		Metal Bowl	
		Part #	Price/E	Part #	Price/E
1/4"	51	L72M-2	\$111.55	L72M-2MB	\$129.10

SCFM ratings given at 90 PSIG inlet pressure.



with transparent bowl

Series 1 Compact Micro-Fog Lubricators

Features:

- 4 oz. reservoir
- in-line or modular installation
- quick release bayonet bowl
- micro-fog design delivers aerosol mist
- recommended lubricants: misting type oil rated 50 to 200 SSU (ISO Grade 7 to 46) at **100°F (38°C)**
- maximum operating conditions:
 - transparent bowl: **150 PSI and 125°F (52°C)**
 - metal bowl: **250 PSI and 175°F (79°C)**

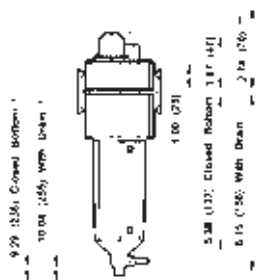

Port Size	Flow (SCFM)	Transparent Bowl		Metal Bowl	
		Part #	Price/E	Part #	Price/E
1/4"	70	L73M-2	\$150.70	L73M-2MB	\$159.10
3/8"	70	L73M-3	150.70	L73M-3MB	159.10
1/2"	70	L73M-4	149.10	L73M-4MB	159.10

SCFM ratings given at 90 PSIG inlet pressure.



with transparent bowl

See pages G-106 to G-111 for accessories.



FRL's are designed for air service only, unless otherwise indicated.

Applications:

- Micro-fog lubricators, identified by a red adjusting screw, are used for applications containing one or more points of lubrication, cylinders and multiple or single tools.
- Air flow through the lubricator lifts oil from the reservoir to the sight-feed dome. Oil is dropped into the fog generator and atomized into a fine mist. Lightweight particles are delivered downstream for lubrication. Heavier particles fall back into the reservoir.
- The micro-fog lubricator delivers 10% of the oil drops visible through the transparent sight-feed dome.



- *Micro-fog lubricators cannot be filled under pressure.*

Series 1 Standard Micro-Fog Lubricators

Features:

- 7 oz. reservoir
- in-line or modular installation
- quick release bayonet bowl
- micro-fog design delivers aerosol mist
- recommended lubricants: misting type oil rated 50 to 200 SSU (ISO Grade 7 to 46) at **100°F (38°C)**
- maximum operating conditions:
 - transparent bowl: **150 PSI** and **125°F (52°C)**
 - metal bowl: **250 PSI** and **175°F (79°C)**



transparent bowl

Port Size	Flow (SCFM)	Transparent Bowl		Metal Bowl	
		Part #	Price/E	Part #	Price/E
3/8"	114	L74M-3	\$190.75	L74M-3MB	\$195.95
1/2"	154	L74M-4	188.10	L74M-4MB	192.15
3/4"	142	L74M-6	188.95	L74M-6MB	192.15

SCFM ratings given at 90 PSIG inlet pressure.

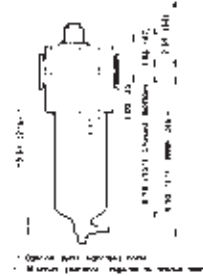

Series 1 Jumbo Micro-Fog Lubricators

Features:

- 1 qt. reservoir
- oil level sight gauge
- one turn threaded bowl attachment permits easy maintenance
- inlet pressure: **250 PSI**
- maximum temperature: **175°F (79°C)**



Port Size	Flow (SCFM)	Metal Bowl with Sight Glass	
		Part #	Price/E
3/4"	160	L17-600A	\$387.80
1"	275	L17-800A	382.25
1 1/4"	275	L17-A00A	459.50
1 1/2"	275	L17-B00A	453.80

SCFM ratings given at 90 PSIG inlet pressure.

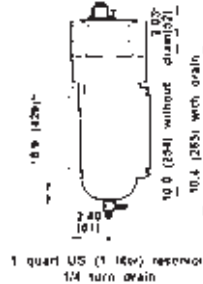

Series 1 Jumbo General Purpose Oil-Fog Lubricators

Features:

- 2 gallon reservoir
- oil flow can be positively set
- reservoir is ASME constructed
- inlet pressure: **250 PSI**
- maximum temperature: **175°F (79°C)**
- oil level sight gauge



Port Size	Flow (SCFM)	Metal Bowl with Sight Glass	
		Part #	Price/E
2"	1000	10-076-004	\$6368.55

See pages G-106 to G-111 for accessories.

See page G-51 for air tool lubricant.

SCFM ratings given at 100 PSIG inlet pressure.

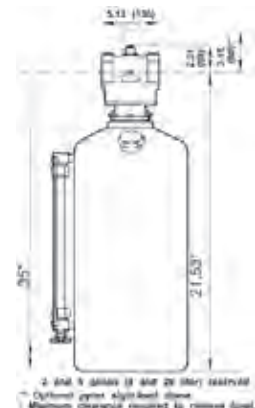

FRL's are designed for air service only, unless otherwise indicated.

Series 1 Micro-Fog Lubricator with Pyrex Sight Feed Dome

Application:

- Designed for use with alcohol or other anti-freeze agents when units are installed in cold temperature environments.
- Micro-fog lubricators are used for applications containing one or more points of lubrication, cylinders and multiple or single tools.
- Air flow through the lubricator lifts oil from the reservoir to the sight-feed dome. Oil is dropped into the fog generator and atomized into a fine mist. Lightweight particles are delivered downstream for lubrication. Heavier particles fall back into the reservoir.

Features:

- high pressure sight feed dome with aluminum case and fluorocarbon O-rings and seals; high pressure sight glass on bowls and metal petcock drain
- The micro-fog lubricator delivers 10% of the oil drops visible through the transparent sight-feed dome.
- *Micro-fog lubricators cannot be filled under pressure.*



Compact

Features:

- 4 oz. reservoir
- in-line or modular installation
- quick release bayonet bowl
- micro-fog design delivers aerosol mist
- recommended lubricants: misting type oil rated 50 to 200 SSU (ISO Grade 7 to 46) at 100°F
- inlet pressure: **250 PSI**
- maximum temperature: **175°F (79°C)**

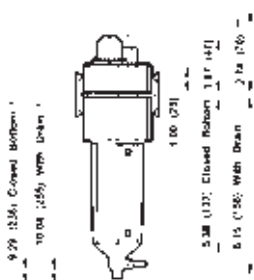

Port Size	Flow (SCFM)	Metal Bowl with Sight Glass	
		Part #	Price/E
3/8"	60	L73M-3MBPX	\$304.05
1/2"	60	L73M-4MBPX	306.90

Standard

Features:

- 7 oz. reservoir
- in-line or modular installation
- quick release bayonet bowl
- micro-fog design delivers aerosol mist
- recommended lubricants: misting type oil rated 50 to 200 SSU (ISO Grade 7 to 46) at 100°F
- inlet pressure: **250 PSI**
- maximum temperature: **175°F (79°C)**

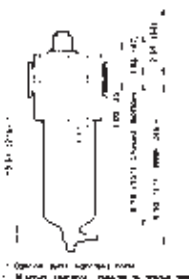

Port Size	Flow (SCFM)	Metal Bowl with Sight Glass	
		Part #	Price/E
3/8"	114	L74M-3MBPX	\$374.90
1/2"	154	L74M-4MBPX	374.90
3/4"	142	L74M-6MBPX	323.75

Jumbo

Features:

- 1 qt. reservoir
- oil level sight gauge
- particle removal per ISO 8573-1, class 5 and class 3
- one turn threaded bowl attachment permits easy maintenance
- inlet pressure: **250 PSI**
- maximum temperature: **175°F (79°C)**

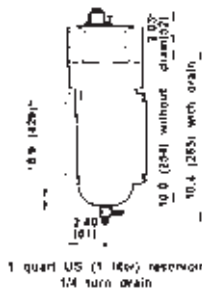

Port Size	Flow (SCFM)	Metal Bowl with Sight Glass	
		Part #	Price/E
1"	275	L17-800APX	\$428.20

See pages G-106 to G-111 for accessories.

See page G-51 for air tool lubricant.



FRL's are designed for air service only, unless otherwise indicated.

SCFM ratings given at 90 PSIG inlet pressure.

Series 1 Standard Oil-Fog Lubricators

Applications:

- Oil-fog lubricators, identified by a green adjusting screw, are used for lubricating a single air tool or air motor and should be installed as near the device as possible.

Features:

- all the oil visible dropping through the transparent sight-feed dome goes to the airstream
- L72C, L73C and L74C OIL-FOG lubricators can be filled under pressure
- in-line or modular installation
- quick release bayonet bowl
- can be filled under pressure
- recommended lubricants: misting type oil rated 50 to 200 SSU (ISO Grade 7 to 46) at 100°F
- maximum operating conditions:
 - transparent bowl: **150 PSI** and **125°F (52°C)**
 - metal bowl: **250 PSI** and **175°F (79°C)**
- 7 oz. reservoir



metal bowl

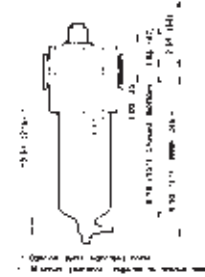

Port Size	Flow (SCFM)	Transparent Bowl		Metal Bowl	
		Part #	Price/E	Part #	Price/E
3/8"	118	L74C-3	\$192.60	L74C-3MB	\$195.95
1/2"	192	L74C-4	190.75	L74C-4MB	193.10
3/4"	186	L74C-6	190.75	L74C-6MB	195.95

Series 1 Jumbo Oil-Fog Lubricators

Application:

- Oil-fog lubricators, identified by a green adjusting screw, are used for lubricating a single air tool or air motor and should be installed as close to the device as possible.

Features:

- 1 qt. reservoir
- oil level sight gauge
- All the oil visible dropping through the transparent sight-feed dome goes to the airstream.
- one turn threaded bowl attachment permits easy maintenance
- inlet pressure: **250 PSI**
- maximum temperature: **175°F(79°C)**

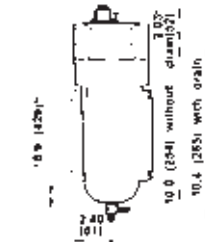

metal bowl

1 quart US (1 liter) reservoir
1/4 turn drain

Port Size	Flow (SCFM)	Metal Bowl with Sight Glass	
		Part #	Price/E
3/4"	160	L17-600D	\$387.80
1"	275	L17-800D	387.80
1 1/2"	275	L17-B00D	453.80

See pages G-106 to G-111 for accessories.
See page G-51 for air tool lubricant.

 FRL's are designed for air service only, unless otherwise indicated.

SCFM ratings given at 90 PSIG inlet pressure.

Series 1 Compact Combination Units

Features:

- 5-150 PSI range
- 4 oz. reservoir
- inlet pressure:
 - transparent bowl: **150 PSI** and **125°F (52°C)**
 - metal bowl: **250 PSI** and **175°F (79°C)**
- supplied with a G230 gauge
- connected modularly
- Includes 2 clamps and wall mounting brackets # 4314-52, 2 clamps # 4314-51 and 2 NPT pipe adapters #4315-01.

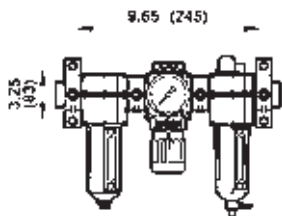

metal bowls

Transparent Bowl

Port Size	Flow (SCFM)	Automatic Drain		Manual Drain	
		Part #	Price/E	Part #	Price/E
1/4"	70	E73-2A	\$681.95	E73-2M	\$602.90
3/8"	70	E73-3A	479.95	E73-3M	601.10
1/2"	70	E73-4A	679.25	E73-4M	601.50

Metal Bowl

Port Size	Flow (SCFM)	Automatic Drain		Manual Drain	
		Part #	Price/E	Part #	Price/E
3/8"	70	E73-3A-MB	\$698.45	E73-3M-MB	\$619.35
1/2"	70	E73-4A-MB	701.00	E73-4M-MB	621.20

Series 1 Standard Combination Units

Features:

- pressure range 5-150 PSI
- 7 oz. reservoir
- inlet pressure:
 - transparent bowl: **150 PSI** and **125°F (52°C)**
 - metal bowl: **250 PSI** and **175°F (79°C)**
- models supplied with a GC230 gauge
- connected modularly
- Includes 2 clamps and wall mounting brackets # 4314-52, 2 clamps # 4314-51 and 2 NPT pipe adapters.

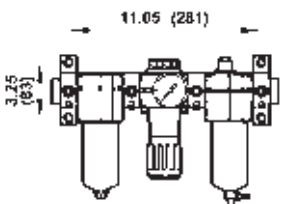

transparent bowl with guard

Transparent Bowl and Guard

Port Size	Flow (SCFM)	Automatic Drain		Manual Drain	
		Part #	Price/E	Part #	Price/E
1/2"	150	E74-4A	\$822.75	E74-4M	\$747.20
3/4"	140	E74-6A	823.75	E74-6M	745.80

Metal Bowl and Sight Glass

Port Size	Flow (SCFM)	Automatic Drain		Manual Drain	
		Part #	Price/E	Part #	Price/E
3/8"	110	E74-3A-MB	\$840.30	E74-3M-MB	\$762.70
1/2"	150	E74-4A-MB	832.85	E74-4M-MB	755.50
3/4"	140	E74-6A-MB	830.65	E74-6M-MB	575.45

Series 1 Jumbo Combination Units

Features:

- pressure range 5-125 PSI
- 1 qt. reservoir
- inlet pressure: **250 PSI**
- maximum temperature: **175°F (79°C)**

Metal Bowl and Sight Glass

Port Size	Flow (SCFM)	Automatic Drain		Manual Drain	
		Part #	Price/E	Part #	Price/E
1"	275	P8A-860A	\$1192.70	P8A-860M	\$1113.40

SCFM ratings given at 90 PSIG inlet pressure.



with metal bowls

FRL's are designed for air service only, unless otherwise indicated.

Series 1 Drip Leg Automatic Drain

**Application:**

- Used in compressed air systems to automatically expel liquids from piping systems. Installed at low points in piping and at end of pipe network where water is likely to accumulate.

Features:

- metal bowl
- drain is ported to 1/8" NPT
- inlet pressure: **250 PSIG**
- maximum temperature: **175°F (79°C)**

Port Size	Part #	Price/E
1/2"	17-016-107	\$315.70

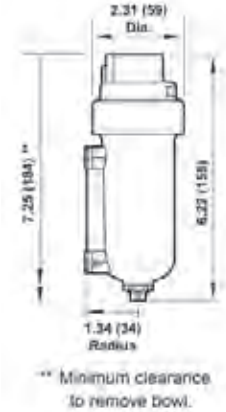

Series 1 Filter Elements



5 micron element
5925-03

Used On	Description	Part #	Price/E
F07	5 micron	3652-11	\$27.95
F08	5 micron	3161-16	27.60
	40 micron	3161-18	27.60
F17	5 micron bronze	5311-01	143.90
	25 micron bronze	5311-02	143.90
	40 micron bronze	5311-03	110.00
F18	5 micron bronze	5882-11	391.00
	25 micron bronze	5882-12	387.40
	50 micron bronze	5882-13	387.40
F72	5 micron	5925-03	17.90
	40 micron	5925-02	14.90
F73	5 micron	4438-01	21.70
	40 micron	4438-03	21.50
F74	5 micron	4338-04	22.70
	40 micron	4338-05	18.15

Series 1 Filter Bowl / Bowl Guards



transparent bowl and guard
4325-51R

Used On	Description	Part #	Price/E
F07	polycarbonate bowl with auto drain	3646-51	\$38.80
	polycarbonate bowl with manual drain	3646-53	26.40
F08	transparent bowl with manual drain	3776-50	100.85
F17	metal bowl with petcock drain	5390-77	266.60
F72	transparent bowl with manual drain	4266-50RF	49.10
	transparent bowl with semi-automatic drain	4266-52RF	66.80
F73	transparent bowl with manual drain, 1/4 turn	4425-50RF	71.40
	transparent bowl with auto drain	4425-51RF	181.50
F74	plastic bowl assembly with guard and 1/4 turn manual drain	4325-51R	67.60
	plastic bowl assembly with guard and automatic drain	4325-52R	165.55

Series 1 Drains

Used On	Description	Part #	Price/E
F08,F17	auto drain	3000-10	\$87.50
	manual drain	619-50	16.35
	manual drain assembly	2796-52	19.40
F72,F73	auto drain	4000-51R	44.95
F74	auto drain	3000-10	87.50
F72,F73 F74	manual drain	619-50	16.35



auto drain
3000-10

Series 1 Filter Lens Kits

Used On	Description	Part #	Price/E
F72	liquid level lens kit	4380-020	\$23.40
F73	liquid level lens kit	4380-030	23.75
F74	high pressure dome sight glass kit	4380-051	36.70



liquid level lens kit
4380-030

Series 1 Filter Indicator Conversion Kit

Features:

- allows addition of service life indicator in the field
- for general purpose and oil removal filters

Used On	Description	Part #	Price/E
F72,F73,F74	service life indicator	5797-50	\$83.50



Series 1 Filter Service Kit

Used On	Description	Part #	Price/E
F17	O-rings, seals, and gaskets	5578-05	\$40.15
F18		5945-50	49.55
F73		4380-600	15.10
F74		4380-700	16.15

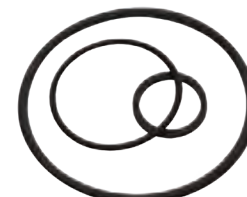

4380-700

Series 1 Filter Oil Removal Filters

Used On	Description	Part #	Price/E
F74C	oil removal filter	4344-01	\$121.20
F74H	oil removal filter	4344-02	179.65
F74V	vapor removal filter	4341-01	225.05



Series 1 Regulator Springs

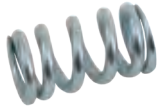

4432-02

Used On	Pressure Ratings	Part #	Price/E
R74	5-60 PSI	4332-01	\$16.00
	5-150 PSI	4332-02	16.00

Series 1 Tamper Resistant Covers

Features:

- helps prevent unauthorized pressure adjustment setting
- cover can be locked in place with up to four padlocks
- installs on adjusting knob



Used On	Description	Part #	Price/E
R72	tamper resistant cover with seal wire	4255-51	\$19.60
R73	tamper resistant cover with seal wire	4455-51	25.75
R74	tamper resistant cover with seal wire	4355-51	25.50

Series 1 Regulator Panel Nuts



panel nut

Used On	Description	Part #	Price/E
R07	plastic panel nut	2962-89	\$9.55
R08	plastic panel nut	5191-89	19.10
R17	metal panel nut	5226-97	40.70
R72	plastic panel nut	4248-89	11.95
R73	zinc panel nut	5191-88	13.80
R74	zinc panel nut	4348-89	11.90

Series 1 Regulator Diaphragm Relieving Kits



3407-02



4381-700

Used On	Description	Part #	Price/E
R07	diaphragm, relieving	3407-02	\$33.75
R08		5298-14	83.65
R11		529-03	132.70
R17		5578-02	116.50
R72		4381-500	28.85
R73		4381-600	43.65
R74		4381-700	50.00

Series 1 Lubricator Bowl / Bowl Guards

Used On	Description	Part #	Price/E
L07	polycarbonate bowl with manual drain	3646-54	\$23.70
L73	transparent bowl with manual drain	4425-50RL	81.15
L74	metal bowl with liquid level indicator and ¼ turn manual drain	4303-77R	144.60
	transparent bowl with manual drain	4325-50R	68.25



3646-54

Series 1 Seal Wire

Features:

- provides tamper resistant protection of the lubricator drip rate setting

Used On	Description	Part #	Price/E
L73, L74	metal wire	2117-01	\$17.40



seal wire

Series 1 Domes, Caps and Plugs

Used On	Description	Part #	Price/E
L08	quick fill cap	18-011-024	\$34.00
L17, L74	quick fill cap	18-011-021	48.15
L73, L74	aluminum fill plug	5301-55	15.75
L17, L72, L73, L74	sight feed dome (micro-fogging design)	4055-50	33.70
L72, L74	sight feed dome (oil-fogging design)	4055-51	33.50
L74	high pressure sight feed dome	5605-50	190.80
	liquid level indicator repair kit	4380-050	36.95



18-011-021



5605-50

Series 1 Lubricator Seal Kits

Used On	Description	Part #	Price/E
L17	O-rings, seals, and gaskets	5771-02	\$16.75
L73		4382-600	17.35
L74		4382-700	14.90



5771-02

Series 1 Quick Clamps and Brackets

Features:

Quick-clamp

- provides modular installation capability
- flanges designated to slide into V grooves in clamp
- face-sealing O-rings provide a positive seal when clamp is closed and screw tightened

Bracket for quick-clamp

- provides secure mounting to a wall, machine panel or other flat surface

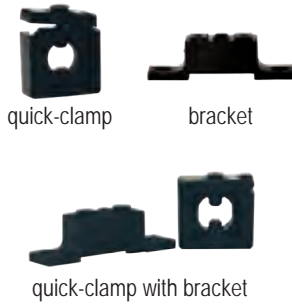

Used On Filter/ Regulator/ Lubricator Series	Description	Part #	Price/E
L72	quick-clamp	4214-51	\$21.05
F72	quick-clamp service kit (2 O-rings)	4384-570	14.90
R72	quick-clamp and bracket assembly	4214-52	27.15
F73, F74, R73, R74, L72, L73	quick-clamp	4314-51	21.95
	quick-clamp service kit (2 O-rings)	4384-770	16.45
	wall bracket for quick-clamp (uses 7/32" screws)	4313-50	17.85
	quick-clamp and bracket assembly	4314-52	33.55

Series 1 Blocks

Features:

- installed with quick-clamps
- provides additional outlets and manifolding capability



Used On Filter/ Regulator/ Lubricator Series	Description	Part #	Price/E
F73, F74, R73, R74, L73, L74	porting block, three 1/4" PTF outlets	4316-50	\$45.70
	manifold block, three 3/4" PTF outlets	4328-50	90.75

Series 1 Pipe Adapters

Features:

- installed with quick-clamps
- provides PTF connections to system piping
- sold individually



Used On Filter/ Regulator/ Lubricator Series	Description	Part #	Price/E
L72, F72, R72	1/4" PTF connections	4215-02	\$36.80
	3/8" PTF connections	4215-03	24.10
F73, F74, R73, R74, L73, L74	1/4" PTF connections	4315-01	31.35
	3/8" PTF connections	4315-02	30.70
	1/2" PTF connections	4315-03	32.20
	3/4" PTF connections	4315-04	30.70

- Used on Filters / Regulators / Lubricator series

Series 1 Mounting Brackets

Used On	Description	Part #	Price/E
F07	mounting bracket only	5939-06	\$17.25
L07	mounting bracket only	5095-17	17.95
F17, L17	mounting bracket kit for 3/4" and 1" ported units	6212-50	134.15



Series 1 Wall Mounting Brackets

Features:

- alternate to quick-clamps and pipe adapters
- used to secure to a wall, machine panel or other flat surface
- Use close nipples on page J-10 to connect combination unit and then place in bracket.

Used On Filter/ Regulator/ Lubricator Series	Description	Part #	Price/E
L72, F72, R72	wall mounting bracket for all F72 series	4224-50	\$23.40
L73, F73, R72	wall mounting bracket for all F73 series	4424-50	21.90
L74, F74, R74	wall mounting bracket for all F74 series	4324-50	29.30



Series 1 Regulator Mounting Brackets

Used On Filter/ Regulator/ Lubricator Series	Description	Part #	Price/E
B07, R07	mounting bracket with plastic panel nut	18-025-003	\$20.45
B08, R08		5203-06	38.25
R17		5570-04	51.95



- Used on Filters / Regulators / Lubricator series

Watts Compact Filters

Features:

- 40 micron polypropylene element
- 4.4 oz. bowl
- zinc body
- maximum operating:
 - temperature range: **40°F (4°C) to 125°F (52°C)**
 - maximum pressure: **150 PSIG (10.2 bar)**



Polycarbonate bowl with guard

Polycarbonate Bowl with Metal Bowl Guard

Size	Flow (SCFM)	Automatic Drain		Manual Drain	
		Part #	Price/E	Part #	Price/E
1/4"	53	F602-02BJR	\$189.70	F602-02BJ	\$125.45
3/8"	80	F602-03BJR	189.70	F602-03BJ	125.45
1/2"	85	F602-04BJR	189.70	F602-04BJ	125.45

Zinc Bowl with Sight Glass

Size	Flow (SCFM)	Automatic Drain		Manual Drain	
		Part #	Price/E	Part #	Price/E
1/4"	53	F602-028A	\$196.85	F602-024A	\$136.60
3/8"	80	F602-038A	196.85	F602-034A	136.60
1/2"	85	F602-048A	202.15	F602-044A	136.60

SCFM ratings given at 90 PSIG inlet pressure.

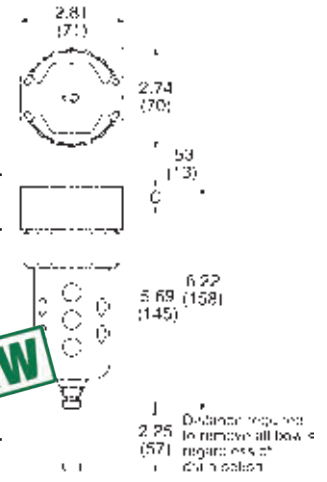

Watts Hi-Flow Filters

Features:

- 40 micron polypropylene element
- 16 oz. bowl
- zinc body with sight glass
- automatic drain operating conditions:
 - temperature range: **40°F (4°C) to 120°F (49°C)**
 - maximum operating: **175 PSIG (12 bar)**
- manual drain operating conditions:
 - temperature range: **40°F (4°C) to 150°F (66°C)**
 - maximum operating: **250 PSIG (17 bar)**



Size	Flow (SCFM)	Automatic Drain		Manual Drain	
		Part #	Price/E	Part #	Price/E
3/4"	270	F602-06WJR	\$399.80	F602-06WJ	\$335.55
1"	300	F602-08WJR	399.80	F602-08WJ	335.55
1 1/2"	450	F602-12WJR	468.20	F602-12WJ	403.95

SCFM ratings given at 90 PSIG inlet pressure.

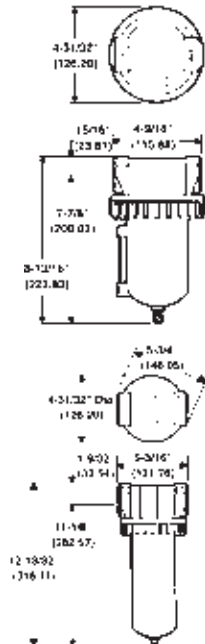

Features:

- 40 micron polypropylene element
- 26 oz. bowl
- aluminum body
- automatic drain operating conditions:
 - temperature range: **40°F (4°C) to 120°F (49°C)**
 - maximum operating: **175 PSIG (12 bar)**
- manual drain operating conditions:
 - temperature range: **40°F (4°C) to 150°F (66°C)**
 - maximum operating: **250 PSIG (17 bar)**



Size	Flow (SCFM)	Automatic Drain		Manual Drain	
		Part #	Price/E	Part #	Price/E
2"	1200	F602-16WJR	1337.55	F602-16WJ	1273.20

See pages G-117 to G-118 for accessories.

! FRL's are designed for air service only, unless otherwise indicated.

SCFM ratings given at 90 PSIG inlet pressure.

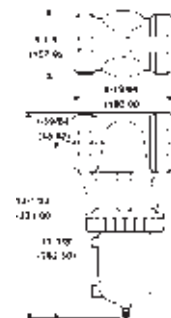

Watts Compact Filters/Regulators

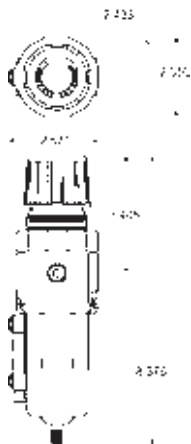

Features:

- pressure range **2 - 125 PSIG** (.15 - 8.5 bar)
- temperature range: **40°F (4°C) to 120°F (49°C)**
- 40 micron filter
- 4 oz. bowl
- zinc body
- relieving type
- diaphragm operated
- spring adjustment mechanism
- glass-filled acetal plastic spring cage
- tamper resistant, snap lock, removable knobs
- uses a GC230 gauge (not supplied)



Size	Flow (SCFM)	Automatic Drain		Manual Drain	
		Part #	Price/E	Part #	Price/E
1/4"	60	B11-02WJCR	\$301.65	B11-02WJC	\$237.40
3/8"	70	B11-03WJCR	301.65	B11-03WJC	237.40
1/2"	80	B11-04WJCR	301.65	B11-04WJC	237.40

SCFM ratings given at 100 PSIG inlet pressure.

Watts Miniature Regulator

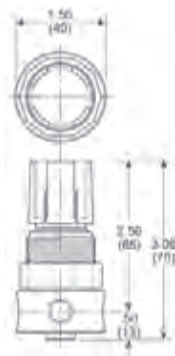

Features:

- pressure range **2 - 125 PSIG** (.15 - 8.5 bar)
- inlet pressure: **300 PSIG** (20.4 bar) maximum
- temperature range: **40°F (4°C) to 120°F (49°C)**
- brass body
- relieving type
- diaphragm operated
- non-rising adjusting knob
- 1/8" gauge port



Size	Flow (SCFM)	With Gauge		Without Gauge	
		Part #	Price/E	Part #	Price/E
1/4"	10	R364-02CG	\$80.35	R364-02C	\$59.05

SCFM ratings given at 100 PSIG inlet pressure.

Watts Compact Regulators

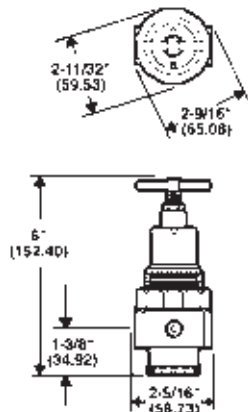

Features:

- pressure range **2 - 125 PSIG** (.15 - 8.5 bar)
- inlet pressure: **300 PSIG** (20.4 bar) maximum
- temperature range: **40°F (4°C) to 120°F (49°C)**
- zinc body
- relieving type
- diaphragm operated
- spring adjustment mechanism
- t-handle design
- uses a GC230 gauge



Size	Flow (SCFM)	With Gauge		Without Gauge	
		Part #	Price/E	Part #	Price/E
1/4"	80	R11-02CG	\$133.30	R11-02C	\$112.00
3/8"	80	R11-03CG	133.30	R11-03C	112.00
1/2"	100	R11-04CG	133.30	R11-04C	112.00

FRL's are designed for air service only, unless otherwise indicated.

SCFM ratings given at 100 PSIG inlet pressure.

Watts Standard Regulators

**Features:**

- pressure range **2 - 125 PSIG** (.15 - 8.5 bar)
- inlet pressure: **300 PSIG** (20.4 bar) maximum
- temperature range: **40°F (4°C) to 120°F (49°C)**
- zinc body
- relieving type
- diaphragm operated
- spring adjustment mechanism
- t-handle design
- brass bottom plug
- aluminum spring cage
- uses a GC230 gauge

Size	Flow (SCFM)	With Gauge		Without Gauge	
		Part #	Price/E	Part #	Price/E
1/4"	100	<i>R119-02CG</i>	\$157.15	<i>R119-02C</i>	\$135.85
3/8"	110	<i>R119-03CG</i>	157.15	<i>R119-03C</i>	135.85
1/2"	150	<i>R119-04CG</i>	183.05	<i>R119-04C</i>	161.75

SCFM ratings given at 100 PSIG inlet pressure.

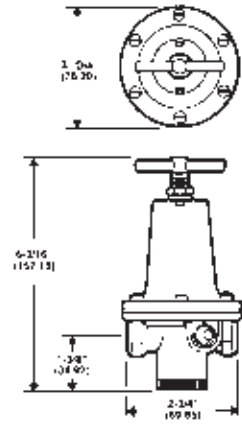
**Features:**

- pressure range **2 - 125 PSIG** (.15 - 8.5 bar)
- inlet pressure: **300 PSIG** (20.4 bar) maximum
- temperature range: **40°F (4°C) to 120°F (49°C)**
- zinc body
- relieving type
- diaphragm operated
- spring adjustment mechanism
- t-handle design
- acetal bottom plug
- aluminum spring cage
- uses a GC230 gauge

Size	Flow (SCFM)	With Gauge		Without Gauge	
		Part #	Price/E	Part #	Price/E
3/4"	300	<i>R119-06CG</i>	\$285.55	<i>R119-06C</i>	\$264.20
1"	400	<i>R119-08CG</i>	285.55	<i>R119-08C</i>	264.20
1 1/2"	500	<i>R119-12CG</i>	354.35	<i>R119-12C</i>	333.00

SCFM ratings given at 100 PSIG inlet pressure.

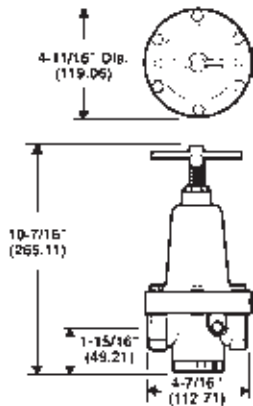

See pages G-117 to G-118 for accessories.

 FRL's are designed for air service only, unless otherwise indicated.

Watts Lubricators

General Features:

- general purpose use
- high performance over a very wide flow range

Watts Compact Lubricators

Features:

- 2.6 oz. bowl
- zinc body
- micromist
- maximum operating conditions:
 - temperature range: **40°F (4.4°C) to 125°F (52°C)**
 - maximum operating pressure: **150 PSIG (10.2 bar)**



Polycarbonate bowl with guard

Size	Flow (SCFM)	Polycarbonate Bowl with Metal Bowl Guard		Zinc Bowl Sight Glass with Twist Drain	
		Part #	Price/E	Part #	Price/E
1/4"	40	L606-02B	\$152.25	L606-024B	\$163.15
3/8"	60	L606-03B	152.25	L606-034B	158.40
1/2"	90	L606-04B	152.25	L606-044B	164.75

SCFM ratings given at 90 PSIG inlet pressure.

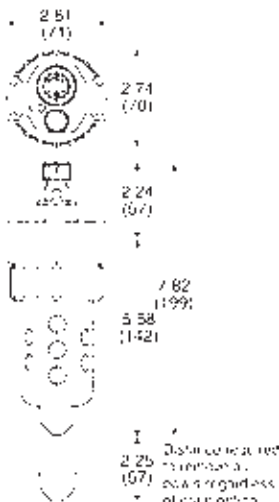

Watts Standard Lubricators

Features:

- 16 oz. bowl
- zinc body
- maximum operating conditions:
 - temperature range: **40°F (4°C) to 150°F (66°C)**
 - maximum operating pressure: **250 PSIG (17 bar)**
- 3/4", 1" and 1 1/2" are fillable while under pressure

Size	Flow (SCFM)	Zinc Bowl with Sight Glass	
		Part #	Price/E
3/4"	325	L606-06W	\$343.85
1"	350	L606-08W	343.85
1 1/2"	400	L606-12W	409.45



L606-12W

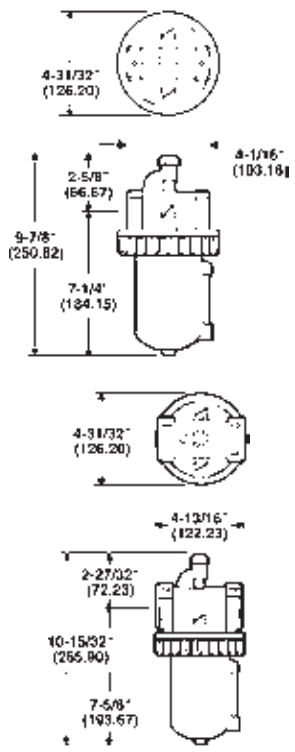

See pages G-117 to G-118 for accessories.
See page G-51 for air tool lubricant.

FRL's are designed for air service only, unless otherwise indicated.

SCFM ratings given at 90 PSIG inlet pressure.

Watts Compact Combination Units

Features:

- 4.5 oz. bowl
- 40 micron polypropylene element
- zinc body
- maximum operating conditions:
 - temperature range: **40°F to 120°F (4°C to 49°C)**
 - maximum operating pressure: **150 PSIG (10.2 bar)**

Polycarbonate Bowl with Metal Bowl Guard

Size	Flow (SCFM)	Automatic Drain		Manual Drain	
		Part #	Price/E	Part #	Price/E
1/4"	40	C11-02A	\$522.35	C11-02M	\$458.05
3/8"	60	C11-03A	525.10	C11-03M	460.85
1/2"	85	C119-04A	578.10	C119-04M	513.85

SCFM ratings given at 90 PSIG inlet pressure.

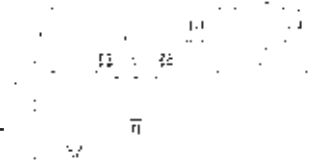

Watts Standard Combination Units

Features:

- 16 oz. bowl
- 40 micron polypropylene element
- zinc body
- maximum operating conditions:
 - temperature range: **40°F to 150°F (4°C to 66°C)**
 - maximum operating pressure: **250 PSIG (17 bar)**

Zinc Bowl with Sight Glass

Size	Flow (SCFM)	Automatic Drain		Manual Drain	
		Part #	Price/E	Part #	Price/E
3/4"	275	C119-06AMB	\$1085.80	C119-06MMB	\$1021.55
1"	320	C119-08AMB	1077.55	C119-08MMB	1013.30
1 1/2"	550	C119-12AMB	1284.50	C119-12MMB	1220.20

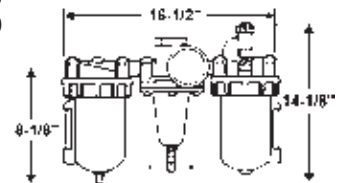
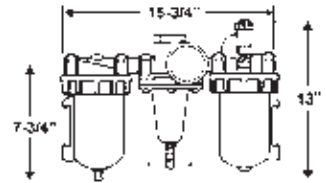

 FRL's are designed for air service only, unless otherwise indicated.

SCFM ratings given at 90 PSIG inlet pressure.

Watts Filter Elements

Used On	Description	Part #	Price/E
F602-02, F602-03, F602-04	40 micron	PS701	\$41.10
F602-06, F602-08, F602-12	5 micron	EK602VB	80.75
F602-06, F602-08, F602-12	40 micron	EK602B	80.75
F602-16	40 micron	EK602G	95.35



Watts Polycarbonate Bowl with Twist Drain

Used On	Description	Part #	Price/E
F602-02 F602-03 F602-04	polycarbonate bowl with twist drain	PS732	\$53.80



Watts Drains

Used On	Description	Part #	Price/E
F602, F602-03, F602-04	auto float drain twist drain	PS506 PS512	\$101.65 15.30



Watts Regulator Repair Kits

Used On	Description	Part #	Price/E
R11	relieving diaphragm, valve assembly	RKR10Y	\$50.35
R119-02		RK119Y	54.25
R119-03		RK119A	66.90
R119-04		RK119B	119.80
R119-06		RK119D	123.80
R119-08		RKR164Y	35.70
R119-12			
R364-02			



Watts Sight Glass Repair Kit



Used On	Description	Part #	Price/E
L606-06 L606-08 L606-12	sight glass	RKB605WB	\$28.05

Watts Filter & Lubricator Mounting Brackets



SA200AW57

Used On	Description	Part #	Price/E
L606-02, F602-02, L606-03, F602-03, L606-04, F602-04	mounting bracket	PS743	\$24.35
F602 3/4", L606-06, F602-06	mounting bracket (2 required)	SA200AW57	32.60
F602 1", L606-08, F602-08	mounting bracket (2 required)	SA200CW57	32.60

Watts Regulator Mounting Brackets



SAR10Y57



SA15Y57

Used On	Description	Part #	Price/E
R11, B11	mounting bracket with panel nut	SAR10Y57	\$17.35
R119-02 R119-03	mounting bracket	SA15Y57	19.10
R119-04	mounting bracket	18A57	22.10
R119-06 R119-08 R119-12	mounting bracket	18B57	56.00
R364-02	mounting bracket with panel nut	SA161X57	16.45

Dixon® Gauges

Applications:

- All of the gauges supplied by Dixon® are designed for long, reliable service under rugged conditions. Typical applications include those on pumps, hydraulic and pneumatic systems, compressors, machine tools and many other installations where it is necessary to have a gauge with a non-corrosive movement. The gauges available include standard dry and liquid-filled pressure gauges, compound pressure gauges, vacuum gauges and welding gauges. Materials available include brass, stainless steel and plastic.

Fig. Inter. - Figure Interval. (Increments between PSI numbers on gauge face.)

Grad. Inter. - Graduation Interval. (Fractional increments between PSI numbers on gauge face.)

ABS Standard Dry Gauges

Features:

- ASME B40.1, Grade B (\pm 3-2-3% accuracy)
- PowerFlex™ movement with polyester segment, designed to resist the effects of shock, vibration and pulsation.
- ABS plastic case, corrosion resistant
- c-shaped bronze safety bourdon tube (600 PSI and lower)
- helical wound bronze safety bourdon tube (1000 PSI and higher)
- polycarbonate window
- black aluminum pointer
- ambient temperature range: -40°F to 150°F (-40°C to 66°C)

Center Back Mounts

PSI Range	Fig. Inter.	Minor Grad.	1½" Face		2" Face	
			¼" Center Back Mount	Part #	Price/E	¼" Center Back Mount
0-15	1	.5	---	---	GC200	\$22.20
0-30	5	.5	GC605	\$16.70	GC215	20.70
0-60	5	1	GC610	16.70	GC220	20.70
0-100	10	2	GC615	16.70	GC225	20.70
0-160	20	5	GC620	16.70	GC230	20.70
0-200	20	5	GC625	16.70	GC235	20.70
0-300	30	5	---	---	GC240	20.70



GC230

Lower Mounts

PSI Range	Fig. Inter.	Minor Grad.	2" face, ¼" lower mount		2½" face ¼" lower mount		3½" face ¼" lower mount	
			Part #	Price/E	Part #	Price/E	Part #	Price/E
0-15	1	.5	GL100	\$19.20	GL300	\$20.40	GS15-4	\$28.10
0-30	5	.5	GL115	17.75	GL320	18.95	GS30-4	26.60
0-60	5	1	GL120	17.75	GL325	18.95	GS60-4	26.60
0-100	10	2	GL125	17.75	GL330	18.95	GS100-4	26.60
0-160	20	5	GL130	17.75	GL335	18.95	GS160-4	26.60
0-200	20	5	GL135	17.75	GL340	18.95	GS200-4	26.60
0-300	30	5	GL140	17.75	GL345	18.95	GS300-4	26.60
0-400	50	10	---	---	GL347	18.95	GS400-4	26.60
0-600	50	10	---	---	GL350	18.95	GS600-4	26.60
0-1000	200	20	---	---	GL355	28.10	GS1000-4	36.95
0-1500	300	50	---	---	GL360	28.10	---	---
0-2000	400	50	---	---	GL365	28.10	---	---
0-3000	500	100	---	---	GL370	28.10	---	---
0-5000	1000	100	---	---	GL375	28.10	---	---



GL140

Stainless Steel Dry Gauges

Applications:

- Designed for severe service applications, providing the corrosion resistance and durability of a permanently sealed gauge.

Features:

- $\pm 2-1-2\%$ accuracy
- 304 stainless steel case and crimp ring
- polycarbonate window
- $\frac{1}{4}$ " NPT lower mount stainless connector
- 316 stainless bourdon tube and socket
- ambient temperature range: -40°F to 140°F (-40°C to 60°C)



GSS100

PSI Range	Fig. Inter.	Minor Grad.	2½" Face ¼" Lower Mount	
			Part #	Price/E
0-15	3	.2	GSS15	\$104.15
0-30	5	.5	GSS30	104.15
0-60	10	1	GSS60	104.15
0-100	20	2	GSS100	104.15
0-160	20	2	GSS160	104.15
0-200	50	5	GSS200	104.15
0-300	50	5	GSS300	104.15
0-400	100	10	GSS400	104.15
0-600	100	10	GSS600	104.15
0-1000	200	20	GSS1000	104.15
0-1500	300	20	GSS1500	115.30
0-2000	500	50	GSS2000	115.30
0-3000	500	50	GSS3000	115.30
0-5000	1000	100	GSS5000	115.30
0-10000	2000	200	GSS10000	119.00

Features:

- 1.6% accuracy, exceeds ASME B.40.100 Grade B
- 304 series stainless case
- polycarbonate window, 3½" across
- $\frac{1}{4}$ " NPT lower mount stainless connector
- 316L stainless bourdon tube and socket, polyester segment
- temperature range: -40°F to 140°F (-40°C to 60°C)



GSS160-4

PSI Range	Fig. Inter.	Minor Grad.	4" Face ¼" Lower Mount	
			Part #	Price/E
0-15	3	.5	GSS15-4	\$164.00
0-30	5	.5	GSS30-4	164.00
0-60	10	1	GSS60-4	164.00
0-100	20	2	GSS100-4	164.00
0-160	20	2	GSS160-4	164.00
0-200	40	5	GSS200-4	164.00
0-300	50	5	GSS300-4	164.00
0-400	50	10	GSS400-4	164.00
0-600	100	10	GSS600-4	164.00
0-1000	200	10	GSS1000-4	164.00
0-1500	200	20	GSS1500-4	164.00
0-3000	500	50	GSS3000-4	164.00
0-5000	1000	100	GSS5000-4	164.00
0-10000	2000	200	GSS10000-4	179.50

Brass Standard Dry Gauges

Features:

- ASME B40.100 Grade B ($\pm 3/2/3\%$ accuracy)
- polished brass case and ring
- copper alloy bourdon tube
- dual PSI / kPa scale dial
- temperature range **-40°F to 140°F (-40°C to 60°C)**

PSI Range	Fig. Inter.	Grad. Inter.	2½" Face ¼" Lower Mount	
			Part #	Price/E
0-15	3	.2	GBR15	\$53.00
0-30	5	.5	GBR30	53.00
0-60	10	1	GBR60	53.00
0-100	20	2	GBR100	53.00
0-160	20	2	GBR160	53.00
0-200	50	5	GBR200	53.00
0-300	50	5	GBR300	53.00
0-400	100	10	GBR400	53.00
0-600	100	10	GBR600	53.00
0-1000	200	20	GBR1000	62.00
0-1500	300	20	GBR1500	62.00
0-2000	500	50	GBR2000	62.00
0-3000	500	50	GBR3000	62.00
0-5000	1000	100	GBR5000	67.00



Process Gauges

Applications:

- Specifically designed for process, chemical and petroleum industries. Process gauges are engineered to deliver years of accurate service while withstanding vibration, corrosive media and corrosive atmosphere.

Features:

- temperature range: dry **-40°F to 200°F (-40°C to 93°C)**
- case: black impact resistant thermoplastic, with safety blowout back, solid front, integral back flange (dry)
- ring: ethylene propylene
- wetted parts: 316L stainless steel
- window: polycarbonate
- dial: white aluminum
- pointer: black aluminum
- accuracy: $\pm 0.5\%$ ANSI/ASME Grade 2A
- scale: single scale PSI only

PSI Range	Fig. Inter.	Grad. Inter.	4½" Face ½" Lower Mount	
			Part #	Price/E
0-30	5	.2	PGS30	\$177.60
0-60	10	.5	PGS60	177.60
0-100	10	1	PGS100	177.60
0-160	20	1	PGS160	177.60
0-200	20	2	PGS200	177.60
0-300	50	2	PGS300	177.60
0-600	10	5	PGS600	177.60
0-1000	100	10	PGS1000	177.60



FlutterGuard™ Dry Gauges

Features:

- FlutterGuard™ virtually eliminates pointer flutter, making the gauge easier to read and reducing excessive movement wear. Liquid-free casing results in lighter weight and eliminates the chance of gauge leakage.
- ASME B40.1, Grade B ($\pm 3-2-3\%$ accuracy)
- ABS plastic case, corrosion resistant
- C-shaped bronze safety bourdon tube (600 PSI gauges and lower)
- helical wound bronze safety bourdon tube (1000 PSI gauges and higher)
- polycarbonate window
- black aluminum pointer
- PowerFlex™ movement with polyester segment, designed to resist the effects of shock, vibration and pulsation.
- ambient temperature range of **-40°F to 150°F (-40°C to 66°C)**



PSI Range	Fig. Inter.	Minor Grad.	2½" Face ¼" Lower Mount	
			Part #	Price/E
0-15	1	.5	GL300FG	\$22.20
0-30	5	.5	GL320FG	20.70
0-60	5	1	GL325FG	20.70
0-100	10	2	GL330FG	20.70
0-160	20	5	GL335FG	20.70
0-200	20	5	GL340FG	20.70
0-300	30	5	GL345FG	20.70
0-400	50	10	GL347FG	20.70
0-600	50	10	GL350FG	20.70
0-1000	200	20	GL355FG	29.85
0-1500	300	50	GL360FG	29.85
0-2000	400	50	GL365FG	29.85
0-3000	500	100	GL370FG	29.85
0-5000	1000	100	GL375FG	29.85



Stainless Panel Builder Gauges

Applications:

- fits industry standard 2.56" panel hole cutout
- suitable for corrosive environments
- used in gaseous and liquid media

Features:

- ASME B40.100 Grade A $\pm 2-1-2\%$ full scale accuracy
- 316L stainless steel wetted parts
- 304 stainless steel case and ring
- white aluminum with black lettering; stop pin
- black aluminum pointer
- glycerin filled case
- laminated safety glass window lens
- ambient temperature range: -4°F to 140°F (-20°C to 60°C)
- maximum media temperature 212°F maximum

PSI Range	Fig. Inter.	Minor Grad.	2½" Face ¼" Lower Back Mount	
			Part #	Price/E
0-15	3	.2	PBLSS15	\$154.50
0-30	5	.5	PBLSS30	154.50
0-60	10	1	PBLSS60	154.50
0-100	20	2	PBLSS100	154.50
0-160	20	2	PBLSS160	154.50
0-200	50	5	PBLSS200	154.50
0-300	50	5	PBLSS300	154.50
0-400	100	10	PBLSS400	154.50
0-600	100	10	PBLSS600	154.50
0-800	200	20	PBLSS800	154.50
0-1000	200	20	PBLSS1000	154.50
0-1500	300	20	PBLSS1500	154.50
0-2000	500	50	PBLSS2000	154.50
0-3000	500	50	PBLSS3000	154.50
0-5000	1000	100	PBLSS5000	154.50



Contractor Pressure Gauges

Features:

- accuracy class: $\pm 1\%$ of span
- wetted parts: copper alloy
- window: acrylic, snap in
- dial: aluminum, white
- pointer: aluminum, black, adjustable
- mounting flanged/bracket; rear flange: stainless steel
- case: stainless steel

PSI Range	4½" face, ¼" Lower Mount	
	Part #	Price/E
0-15	4277750-0001	\$71.60
0-30	4277768-0001	71.60
0-60	4277776-0003	71.60





Compound Gauges

Features:

- ASME B40.1, Grade B accuracy ($\pm 3-2-3$ % accuracy)
- ABS plastic case, corrosion resistant
- bronze bourdon tube / brass socket
- polycarbonate window
- black aluminum pointer
- Powerflex movement with polyester segment, designed for extended wear
- temperature range of **-40°F to 150°F (-40°C to 66°C)**

Mercury (Hg)	PSI Range	Fig. Inter. (Hg / PSI)	Minor Grad. (Hg / PSI)	2½" Face		2½" Face	
				¼" Center Mount Part #	Back Mount Price/E	¼" Lower Mount Part #	Price/E
30"	0-100	30 / 10	5 / 2	---	---	GL310	\$20.40
	0-160	30 / 20	5 / 5	GC210	\$29.25	---	---
	0-160	30 / 20	10 / 10	---	---	GL110	20.40
	0-200	30 / 20	10 / 10	---	---	GL315	20.40

Vacuum Gauges

Features:

- ASME B40.1, Grade B accuracy ($\pm 3-2-3$ % accuracy)
- ABS plastic case
- bronze bourdon tube
- polycarbonate crystal
- black aluminum pointer
- Powerflex movement with polyester segment, designed for extended wear
- temperature range: **-40°F to 150°F (-40°C to 66°C)**



Mercury (Hg)	Fig. Inter. (Hg / PSI)	Minor Grad. (Hg / PSI)	2" Face		2" Face		2½" Face	
			¼" Lower Mount Part #	Price/E	¼" Center Back Mount Part #	Price/E	¼" Lower Mount Part #	Price/E
30"	5"	.5"	GL105	\$19.20	GC205	\$22.20	GL305	\$20.40

ABS Case Liquid Filled Gauges

Feature:

- ASME B40.100, Grade B ($\pm 3-2-3\%$ accuracy)

PSI Range	Fig. Inter.	Minor Grad.	2½" Face	
			¼" Lower Mount	Price/E
0-15	3	.2	GLP500	\$35.25
0-30	5	.5	GLP505	35.25
0-60	10	1	GLP510	35.25
0-100	20	2	GLP515	35.25
0-160	20	2	GLP517	35.25
0-200	50	5	GLP520	35.25
0-300	50	5	GLP525	35.25
0-400	100	10	GLP527	35.25
0-600	100	10	GLP530	35.25
0-1000	200	20	GLP535	40.10
0-1500	300	20	GLP540	40.10
0-2000	500	50	GLP545	40.10
0-3000	500	50	GLP550	40.10
0-5000	1000	100	GLP555	40.10



Stainless Case Liquid Filled Gauges

Features:

- PowerFlex™ movement with polyester segment designed to resist the effects of shock, vibration and pulsation.
- ASME B40.100, Grade A ($\pm 2-1-2\%$ accuracy)
- copper alloy bourdon tube
- white aluminum dial with black numbers and black aluminum pointer
- ¼" NPT brass connection
- glycerin filled
- polycarbonate window
- temperature range: -4°F to 150°F (-20°C to 65°C)

PSI Range	Fig. Inter.	Minor Grad.	2½" Face		2½" Face,	
			¼" Center Back Mount	Price/E	¼" Lower Mount	Price/E
0-15	3	.5	GLSC400	\$56.20	GLS400	\$45.50
0-30	5	.5	GLSC405	56.20	GLS405	45.50
0-60	10	1	GLSC410	56.20	GLS410	45.50
0-100	20	2	GLSC415	56.20	GLS415	45.50
0-160	20	2	GLSC417	56.20	GLS417	45.50
0-200	40	5	GLSC420	56.20	GLS420	45.50
0-300	50	5	GLSC425	56.20	GLS425	45.50
0-400	50	5	GLSC427	56.20	GLS427	45.50
0-600	100	10	GLSC430	56.20	GLS430	45.50
0-1000	200	10	GLSC435	56.20	GLS435	45.50
0-1500	300	50	GLSC440	62.10	GLS440	50.90
0-2000	400	20	GLSC445	62.10	GLS445	50.90
0-3000	500	50	GLSC450	62.10	GLS450	50.90
0-5000	1000	100	GLSC455	62.10	GLS455	50.90



GLSC420



GLS430

Stainless Steel Liquid Filled Gauges

Applications:

Designed for severe service applications, providing the corrosion resistance and durability of a permanently sealed gauge.

Features:

- $\pm 2-1-2\%$ accuracy
- polycarbonate window
- $\frac{1}{4}$ " NPT lower mount stainless connector
- 304 stainless case and crimp ring
- glycerin filled
- ambient temperature range: -4°F to 140°F (-20°C to 60°C)



GLSS1500

PSI Range	Fig. Inter.	Minor Grad.	2 1/2" Face 1/4" Lower Mount	
			Part #	Price/E
0-15	3	.2	GLSS15	\$112.40
0-30	5	.5	GLSS30	112.40
0-60	10	1	GLSS60	112.40
0-100	20	2	GLSS100	112.40
0-160	20	2	GLSS160	112.40
0-200	50	5	GLSS200	112.40
0-300	50	5	GLSS300	112.40
0-400	100	10	GLSS400	112.40
0-600	100	10	GLSS600	112.40
0-1000	200	20	GLSS1000	112.40
0-1500	300	20	GLSS1500	112.40
0-2000	500	50	GLSS2000	112.40
0-3000	500	50	GLSS3000	112.40
0-5000	1000	100	GLSS5000	112.40
0-10000	2000	200	GLSS10000	112.40

All Stainless Steel Liquid Filled Gauges

Applications:

Designed for severe service applications, providing the corrosion resistance and durability of a permanently sealed gauge.

Features:

- $\pm 2-1-2\%$ accuracy
- polycarbonate window
- $\frac{1}{4}$ " NPT center back mount stainless connector
- 304 stainless case and crimp ring
- glycerin filled
- ambient temperature range: -4°F to 140°F (-20°C to 60°C)



PSI Range	Fig. Inter.	Minor Grad.	2 1/2" Face 1/4" Center Back Mount	
			Part #	Price/E
0-100	20	2	GLSSC100	\$151.00
0-160	20	2	GLSSC160	151.00
0-200	50	5	GLSSC200	151.00

Brass Liquid Filled Gauges

Features:

- ± 2 -1-2% accuracy on 2½"; ± 1 % accuracy on 4"
- acrylic window with membrane assembly
- copper alloy bourdon tube
- brass movement with highly polished bearing surfaces
- glycerin filled
- 2½" face gauges: solid cast brass case with polished ABS cover ring
- 4" face gauges: cast brass, silver painted case with chrome plated brass cover ring
- ambient temperature range: -4°F to 140°F (-20°C to 60°C)

PSI Range	Fig. Inter.	Minor Grad.	2½" Face ¼" Lower Mount		2½" Face ¼" Center Back Mount		4" Face ½" Lower Mount	
			Part #	Price/E	Part #	Price/E	Part #	Price/E
0-15	3	.2	GLBR15	\$116.50	GLBRC15	\$135.00	GLBR15-4	\$297.25
0-30	5	.5	GLBR30	116.50	GLBRC30	122.10	GLBR30-4	297.25
0-60	10	1	GLBR60	116.50	GLBRC60	122.10	GLBR60-4	297.25
0-100	10	1	GLBR100	116.50	GLBRC100	122.10	GLBR100-4	297.25
0-160	20	2	GLBR160	116.50	GLBRC160	122.10	GLBR160-4	297.25
0-200	20	2	GLBR200	116.50	GLBRC200	122.10	GLBR200-4	297.25
0-300	50	5	GLBR300	116.50	GLBRC300	122.10	GLBR300-4	297.25
0-400	50	5	GLBR400	116.50	GLBRC400	122.10	GLBR400-4	297.25
0-600	100	10	GLBR600	116.50	GLBRC600	122.10	GLBR600-4	297.25
0-1000	100	10	GLBR1000	116.50	GLBRC1000	122.10	GLBR1000-4	297.25
0-1500	300	20	GLBR1500	129.50	GLBRC1500	135.00	GLBR1500-4	324.25
0-2000	200	20	GLBR2000	129.50	GLBRC2000	135.00	GLBR2000-4	324.25
0-3000	500	50	GLBR3000	129.50	GLBRC3000	135.00	GLBR3000-4	324.25
0-5000	500	50	GLBR5000	129.50	GLBRC5000	135.00	GLBR5000-4	324.25
0-10000	1000	100	---	---	---	---	GLBR10000-4	444.00



Welding Gauges

Features:

- ± 3 -2-3% accuracy according to ASME B40.100 Grade B
- polished drawn stainless steel case
- twist-lock polycarbonate window
- copper alloy bourdon tube
- "USE NO OIL" written in red on face
- ambient temperature range: -40°F to 140°F (-20°C to 60°C)

PSI Range	Fig. Inter.	Minor Grad.	2½" Face ¼" Lower Mount	
			Part #	Price/E
0-30	5	.5	GBRW30	\$62.00
0-30	5	.5	GBRW30R¹	62.00
0-60	10	1	GBRW60	62.00
0-100	20	2	GBRW100	62.00
0-200	50	5	GBRW200	62.00
0-400	100	10	GBRW400	62.00
0-600	100	10	GBRW600	62.00
0-4000	500	100	GBRW4000	65.00

¹ red band between 15 to 30 PSI on GBRW30R



General Purpose Digital Gauges

Applications:

- General purpose digital gauges are suitable for dry air applications and other media. Gauge offers selectable units of measure so rather than purchasing one gauge for each unit of measure required, one gauge can be used for multiple units of measure.
- ideal for test applications and for use in technicians tool kits

Features:

- 0.5% terminal point accuracy
- five-digit LCD display with large size .48" characters
- bar graph display (20 segment)
- 9 engineering units (accessed through keypad): PSI, in. HG, cm Hg, mm Hg, KPA, Mpa, BAR, KG/cm², ft H₂O
- IP67 weatherproof enclosure, polycarbonate / ABS
- two AA alkaline batteries included
- 2000 hour minimum battery life
- wetted parts: 17-4 PH stainless steel sensor with 316L stainless steel socket
- operating temperature: **-4°F to 140°F (-20°C to 60°C)**
- polycarbonate window
- other pressure and compound ranges available



PSI Range	2 1/2" Face 1/4" Lower Mount	
	Part #	Price/E
0-100	DG100	\$877.00
0-300	DG300	877.00
0-1000	DG1000	877.00
0-10,000	DG10000	877.00

180° Steam Gauge Siphons

Application:

- In steam service, the siphon will prevent hot steam from entering a pressure gauge, diaphragm seal or transmitter. Recommended for applications involving temperatures above **100°F (37°C)**. Also use siphons whenever condensing hot vapors (not just steam) are present.



Features:

- red brass pipe
- complies with ASTM B-43
- pressure rating: **200 PSI at 406°F (208°C)**



Male IPS	Red Brass	
	Part #	Price/E
1/4"	401-01	\$33.25

Features:

- steel pipe
- 1/4" NPT schedule 40 steel, welded
- pressure rating: **175 PSI at 340°F (171°C)**



Male IPS	Steel	
	Part #	Price/E
1/4"	401-01S	\$14.25

Bi-Metal Thermometers

Features:

- case: sturdy, corrosion resistant series 304 stainless steel
- bezel crystal: optically clear, strong glass, gasketed to maintain weather-tight integrity is standard
- stem: 304 series stainless steel, welded at tip and case connector to prevent leakage, 1/4" (6.35 mm) diameter
- hermetically sealed per ASME B40.3 external reset
- slotted-hex adjustment head offers screwdriver or wrench use to field calibrate the thermometer
- bi-metal element: an extremely responsive temperature sensing helix which has been carefully sized and tested, heat treated and aged to relieve inherent stresses and insure continued accuracy
- dampening: bi-metal helix is coated with a viscous silicone to minimize pointer oscillation and to improve temperature transmission
- immersion: for accurate temperature readings, immerse stem a minimum of 2" (50 mm) in agitated liquids or 4" (100 mm) in moving air or gas
- over range: temporary over or under range of 50% of scale up to **260°C or 500°F** will not affect the instrument accuracy
- accuracy: guaranteed to be accurate to within 1% of full scale (Grade A per ASME B40.3) (The American Society of Mechanical Engineers issued a new standard for Bi-Metal Thermometers in 1990 referred to as ASME B40.3.)
- standard connection is 1/2" male NPT

Model 30 Back Connected

Stem Length	Temperature Range	3" Face	
		Part #	Price/E
2½"	0-250°F/10-120°C	30025064	\$60.15
2½"	50-500°F/10-260°C	30025104	60.15
4"	0-250°F/10-120°C	30040064	60.15
4"	50-500°F/10-260°C	30040104	60.15
6"	0-250°F/10-120°C	30060064	60.15
6"	50-500°F/10-260°C	30060104	60.15
9"	0-250°F/10-120°C	30090064	60.15
9"	50-500°F/10-260°C	30090104	60.15



Model 31 Bottom Connected 90° Angle

Stem Length	Temperature Range	3" Face	
		Part #	Price/E
2½"	0-250°F/10-120°C	31025064	\$119.70
4"	50-500°F/10-260°C	31040104	119.70



Model 50 Back Connected

Stem Length	Temperature Range	5" Face	
		Part #	Price/E
2½"	50-500°F/10-260°C	50025104	\$133.45
4"	0-250°F/10-120°C	50040064	133.45



Model 52 Adjustable Angle

Stem Length	Temperature Range	5" Face	
		Part #	Price/E
2½"	0-250°F/10-120°C	52025064	\$181.05
4"	0-250°F/10-120°C	52040064	193.35
4"	50-500°F/10-260°C	52040104	193.35





Bi-Metal Pocket Thermometers

Features:

- case: 304 stainless steel hermetically sealed
- crystal: extra heavy polycarbonate
- stem: 304 series stainless steel
- external reset with hex nut on back of case
- bi-metal element: responsive actuation by bi-metal helix
- dampening: bi-metal helix is coated with a viscous silicone to minimize pointer oscillation
- scale length: approximately 2-1/8" (54mm)
- accuracy: 1%
- polyethylene carrying case with clip

Temperature Range	Part #	Price/E
0°F to 220°F (-18°C to 104°C)	PT220	\$21.80
50°F to 550°F (10°C to 288°C)	PT550	21.80

Magnetic Surface Mount Thermometers



Features:

- case: steel, 2" x 1/2"
- dial: polished aluminum
- bi-metal element: responsive actuation by bi-metal helix
- accuracy: ± 2%

Temperature Range	2" Face	
	Part #	Price/E
0°F to 250°F (-18°C to 121°C)	MT250	\$42.40
0°F to 500°F (-18°C to 260°F)	MT500	42.40

Threaded Thermowells

Features:

- 3/4" male NPT process connection

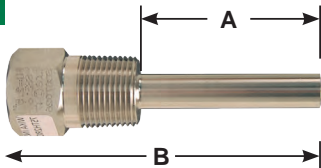

'A' dimension	'B' dimension	316 Stainless Steel	
		Part #	Price/E
1 5/8"	2 1/2"	75TH2R015SS	\$108.60
2 1/2"	4"	75TH2R025SS	87.50
4 1/2"	6"	75TH2R045SS	135.50
7 1/2"	9"	75TH2R075SS	160.00

D.O.T. Push-In Fittings

Features:

- materials:
 - body (straights) tube, supports and grippers: brass CA360
 - forged elbows and tees: brass CA377
 - O-ring: Buna-N
- suitable for use up to the maximum working pressure of the plastic tubing used, also suitable for vacuum service
- temperature range: **-40°F to 212°F (-40°C to 100°C)**
- pre-applied thread sealant (Loctite 516®) on all male pipe threads
- compatible tubing: SAE J844
- meets D.O.T FMVSS 571.106 and SAE J1131, SAE J2494-1 and SAE J2494-3

Male Connectors

Tube OD	Male NPTF	Part #	Price/E	Pkg Qty
1/4"	1/8"	AQ68DOT4X2	\$6.15	10
1/4"	1/4"	AQ68DOT4X4	6.95	10
1/4"	3/8"	AQ68DOT4X6	11.25	5
3/8"	1/4"	AQ68DOT6X4	9.60	10
3/8"	3/8"	AQ68DOT6X6	10.30	10



Union Connectors

Tube OD	Part #	Price/E	Pkg Qty
1/4"	AQ62DOT4	\$11.45	10
3/8"	AQ62DOT6	13.00	10



Male Elbows

Tube OD	Male NPTF	Part #	Price/E	Pkg Qty
1/4"	1/8"	AQ69DOT4X2	\$8.95	10
1/4"	1/4"	AQ69DOT4X4	10.15	10
3/8"	1/4"	AQ69DOT6X4	11.40	10



D.O.T. Push-In Male Swivel Elbows

Tube OD	Male NPTF	Part #	Price/E	Pkg Qty
1/4"	1/8"	AQ69DOTS4X2	\$10.55	10
1/4"	1/4"	AQ69DOTS4X4	11.40	10
1/4"	3/8"	AQ69DOTS4X6	16.45	10
3/8"	1/4"	AQ69DOTS6X4	15.10	10
3/8"	3/8"	AQ69DOTS6X6	17.00	5



Male Swivel Run Tees



Tube OD	Male NPTF	Part #	Price/E	Pkg Qty
1/4"	1/8"	AQ71DOTS4X2	\$17.95	10
1/4"	1/4"	AQ71DOTS4X4	17.95	5

Male Swivel Branch Tees



Tube OD	Male NPTF	Part #	Price/E	Pkg Qty
1/4"	1/8"	AQ72DOTS4X2	\$17.95	10
1/4"	1/4"	AQ72DOTS4X4	18.80	5

Union Tees



Tube OD	Part #	Price/E	Pkg Qty
1/4"	AQ64DOT4	\$17.05	10
3/8"	AQ64DOT6	20.80	10



Legris D.O.T. Push-In Fittings

Features:

- materials: composite body, brass collet, stainless steel tube support, brass threads, Buna-N O-ring
- maximum operating pressure: **250 PSI** at ambient temperature
- temperature range: **-40°F to 200°F (-40°C to 93°C)**
- suitable fluids: compressed air only
- complies with the performance requirements of D.O.T FMVSS 571.106 (SAE J1131) and SAE J2494-3
- *These fittings are designed for use on all pneumatic circuits other than air brake assemblies between the frame and axle or between towed and towing vehicle.*



Male Connectors

Tube OD	Male NPT	Part #	Price/E	Pkg Qty
5/32"	1/8"	31150411DOT	\$5.90	10
5/32"	1/4"	31150414DOT	9.55	10
3/16"	1/8"	31155511DOT	7.75	10
3/16"	1/4"	31155514DOT	11.50	10
1/4"	1/8"	31155611DOT	5.40	10
1/4"	1/4"	31155614DOT	5.95	10
1/4"	3/8"	31155618DOT	8.40	10
3/8"	1/8"	31156011DOT	10.80	10
3/8"	1/4"	31156014DOT	8.55	10
3/8"	3/8"	31156018DOT	11.35	10
3/8"	1/2"	31156022DOT	15.35	10
1/2"	1/4"	31156214DOT	22.55	10
1/2"	3/8"	31156218DOT	21.75	10
1/2"	1/2"	31156222DOT	15.70	10

- meets D.O.T. FMVSS571.106, SAE J2494 and SAE J2494-3



Female Connectors

Tube OD	Female NPT	Part #	Price/E	Pkg Qty
5/32"	1/8"	31140411DOT	\$15.60	10
3/16"	1/8"	31145511DOT	12.90	10
1/4"	1/8"	31145611DOT	11.40	10
1/4"	1/4"	31145614DOT	12.45	10
3/8"	1/4"	31146014DOT	16.55	10
3/8"	3/8"	31146018DOT	24.00	10

- meets D.O.T. FMVSS571.106, SAE J2494 and SAE J2494-3





Unions

Tube OD	Part #	Price/E	Pkg Qty
5/32"	31060400DOT ^{1,2}	\$7.30	10
3/16"	31065500DOT ^{1,2}	11.45	10
1/4"	31065600DOT ³	6.50	10
3/8"	31066000DOT ³	9.75	10
1/2"	31066200DOT ³	16.55	10

¹ brass body² meets D.O.T FMVSS571.106, SAE J2494 and SAE J2494-3³ meets D.O.T FMVSS571.106, J1131 and SAE2494-3

Bulkhead Unions



Tube OD	Part #	Price/E	Pkg Qty
1/4"	31165600DOT	\$12.25	10
3/8"	31166000DOT	19.75	10
1/2"	31166200DOT	34.90	10

• meets D.O.T. FMVSS571.106, SAE J2494 and SAE J2494-3

Union Elbows



Tube OD	Part #	Price/E	Pkg Qty
5/32"	31020400DOT ¹	\$7.20	10
1/4"	31025600DOT	8.50	10
3/8"	31026000DOT	13.55	10
1/2"	31026200DOT	17.35	10

• 5/32" diameter meets D.O.T. FMVSS571.106, SAE J2494 and SAE J2494-3

• 1/4", 3/8" and 1/2" diameters meet D.O.T. FMVSS571.106, J1131 and SAE 2494-3

¹ brass body

Male Elbows



Tube OD	Male NPT	Part #	Price/E	Pkg Qty
5/32"	1/8"	31090411DOT ¹	\$10.50	10
3/16"	1/8"	31095511DOT ¹	14.00	10
1/4"	1/8"	31095611DOT	6.65	10
1/4"	1/4"	31095614DOT	8.05	10
1/4"	3/8"	31095618DOT	16.60	10
3/8"	1/4"	31096014DOT	15.40	10
3/8"	3/8"	31096018DOT	17.75	10
3/8"	1/2"	31096022DOT	17.65	10
1/2"	1/4"	31096214DOT	18.50	10
1/2"	3/8"	31096218DOT	18.35	10
1/2"	1/2"	31096222DOT	22.60	10

• 5/32" and 3/16" diameter meets D.O.T. FMVSS571.106, SAE J2494 and SAE J2494-3

• 1/4", 3/8" and 1/2" diameters meet D.O.T. FMVSS571.106, J1131 and SAE 2494-3

• fitting can be oriented 360° allowing proper positioning of the fitting

¹ brass body

Reducer

Tube OD	Tube OD	Part #	Price/E	Pkg Qty
1/4"	3/8"	31665660DOT	\$5.55	10

- meets D.O.T. FMVSS571.106, J1131 and SAE 2494-3



Plug In Elbow

Tube OD	Part #	Price/E	Pkg Qty
1/4"	31825600DOT	\$4.55	10

- meets D.O.T. FMVSS571.106, J1131 and SAE 2494-3



Male Branch Tees

Tube OD	Male NPT	Part #	Price/E	Pkg Qty
1/4"	1/8"	31085611DOT	\$9.70	10
1/4"	1/4"	31085614DOT	10.90	10
1/4"	3/8"	31085618DOT	28.30	10
3/8"	1/4"	31086014DOT	16.30	10
3/8"	3/8"	31086018DOT	19.75	10
3/8"	1/2"	31086022DOT	21.25	10
1/2"	1/4"	31086214DOT	27.05	10
1/2"	3/8"	31086218DOT	25.05	10
1/2"	1/2"	31086222DOT	28.65	10

- 1/4", 3/8" and 1/2" diameters meet D.O.T. FMVSS571.106, J1131 and SAE 2494-3
- fitting can be oriented 360° allowing proper positioning of the fitting



Union Tees

Tube OD	Part #	Price/E	Pkg Qty
5/32"	31040400DOT¹	\$10.20	10
3/16"	31045500DOT¹	20.30	10
1/4"	31045600DOT	10.20	10
3/8"	31046000DOT	12.95	10
1/2"	31046200DOT	21.55	10

- 5/32" and 3/16" diameter meets D.O.T. FMVSS571.106, SAE J2494 and SAE J2494-3
- 1/4", 3/8" and 1/2" diameters meet D.O.T. FMVSS571.106, J1131 and SAE 2494-3
- ¹ brass body





Legris D.O.T. Push-In Male Run Tees

Tube OD	Male NPT	Part #	Price/E	Pkg Qty
3/16"	1/8"	31035511DOT ¹	\$20.90	10
1/4"	1/8"	31035611DOT	10.85	10
1/4"	1/4"	31035614DOT	12.55	10
1/4"	3/8"	31035618DOT	19.60	10
3/8"	1/4"	31036014DOT	17.40	10
3/8"	3/8"	31036018DOT	20.90	10
3/8"	1/2"	31036022DOT	22.95	10
1/2"	1/4"	31036214DOT	28.55	10
1/2"	3/8"	31036218DOT	28.10	10
1/2"	1/2"	31036222DOT	30.65	10

- 3/16" diameter meets D.O.T. FMVSS571.106, SAE J2494 and SAE J2494-3
- 1/4", 3/8" and 1/2" diameters meet D.O.T. FMVSS571.106, J1131 and SAE 2494-3
- fitting can be oriented 360° allowing proper positioning of the fitting

¹ brass body

Legris D.O.T. Push-In Plug In Run Tee



Tube OD	Part #	Price/E	Pkg Qty
1/4"	31835600DOT	\$11.00	10

- meets D.O.T. FMVSS571.106, J1131 and SAE 2494-3

Legris D.O.T. Push-In Y Connectors



Tube OD	Male NPT	Part #	Price/E	Pkg Qty
1/4"	1/8"	31485611DOT	\$16.35	10
1/4"	1/4"	31485614DOT	15.70	10

- meets D.O.T. FMVSS571.106, J1131 and SAE 2494-3
- fitting can be oriented 360° allowing proper positioning of the fitting

Legris D.O.T. Push-In Y Unions



Tube OD	Part #	Price/E	Pkg Qty
1/4"	31405600DOT	\$11.80	10
3/8"	31406000DOT	19.10	10

- meets D.O.T. FMVSS571.106, J1131 and SAE 2494-3

Air Brake Fittings

Application:

- designed for use in air brake systems or cab controls

Features:

- utilize ribbed sleeve for compression and positive grip
- machined from CA360, CA345, or CA377 brass
- pre-applied thread sealant on all male pipe threads
- maximum operating pressure: **150 PSI**
- temperature range: **-40°F to 200°F (-40°C to 93°C)**
- compatible tubing: SAE J844 type A and B
- specifications: meets D.O.T FMVSS 571.106 and SAE J246

Assembly Instructions:

- Cut tubing squarely - maximum of 15° angle allowable.
- Check that port or mating part is clean and free of debris.
- Insert tubing into fittings until it bottoms on seat.
- Tighten nut with wrench until one thread remains visible on the fittings body; (this will allow for a number of remakes) or, the nut should be screwed down finger tight, then wrench-tightened as indicated in the chart below.

Tube Size	Turns required to seal from hand tight
3/16"	2½
1/4"	3
3/8" & 1/2"	4
5/8" & 3/4"	3½

Male Connectors

Features:

- ref. SAE 100102 BA
- thread sealant may be white or burnt orange

Tube Size	Pipe Thread	Straight Thread	Part #	Price/E	Pkg Qty
3/16"	1/16"	5/16"-24	68NAB31VS	\$20.28	25
3/16"	1/8"	5/16"-24	68NAB32VS	15.78	50
3/16"	1/4"	5/16"-24	68NAB34VS	20.78	25
1/4"	1/8"	7/16"-24	68NAB42VS	5.32	50
1/4"	1/4"	7/16"-24	68NAB44VS	6.30	50
1/4"	3/8"	7/16"-24	68NAB46VS	7.61	10
3/8"	1/8"	17/32"-24	68NAB62VS	9.14	25
3/8"	1/4"	17/32"-24	68NAB64VS	6.30	25
3/8"	3/8"	17/32"-24	68NAB66VS	8.10	25
3/8"	1/2"	17/32"-24	68NAB68VS	12.60	25
1/2"	1/4"	11/16"-20	68NAB84VS	9.75	10
1/2"	3/8"	11/16"-20	68NAB86VS	10.40	25
1/2"	1/2"	11/16"-20	68NAB88VS	13.26	25
5/8"	3/8"	13/16"-18	68NAB106VS	19.07	10
5/8"	1/2"	13/16"-18	68NAB108VS	16.55	10
3/4"	3/8"	1"-18	68NAB126VS	49.35	10
3/4"	1/2"	1"-18	68NAB128VS	26.91	10
3/4"	3/4"	1"-18	68NAB1212VS	29.07	10



Female Connectors

Feature:

- ref. SAE 100103 BA

Tube Size	Pipe Thread	Straight Thread	Part #	Price/E	Pkg Qty
1/4"	1/8"	7/16"-24	66NAB42	\$7.70	25
1/4"	1/4"	7/16"-24	66NAB44	8.46	10
3/8"	1/8"	17/32"-24	66NAB62	9.18	10
3/8"	1/4"	17/32"-24	66NAB64	10.00	10
1/2"	3/8"	11/16"-20	66NAB86¹	15.06	10
1/2"	1/2"	11/16"-20	66NAB88	23.08	10
5/8"	3/8"	13/16"-18	66NAB106	20.92	10
5/8"	1/2"	13/16"-18	66NAB108	27.94	10



¹ not full hex as shown

Unions

Feature:

- ref. SAE 100101



Tube Size	Straight Thread	Part #	Price/E	Pkg Qty
1/4"	7/16"-24	62NAB4	\$7.46	10
3/8"	17/32"-24	62NAB6	9.18	10
1/2"	11/16"-20	62NAB8	14.54	10
5/8"	13/16"-18	62NAB10	21.77	10
3/4"	1"-18	62NAB12	37.15	10

Bulkhead Unions



Tube Size	Straight Thread	Part #	Price/E	Pkg Qty
1/4"	7/16"-24	62NABH4	\$41.00	10
3/8"	17/32"-24	62NABH6	53.20	10
1/2"	11/16"-20	62NABH8	96.62	10

Bulkhead Unions



Tube Size	Straight Thread	Part #	Price/E	Pkg Qty
3/16"	5/16"-24	62NBH3	\$51.55	10
1/4"	7/16"-24	62NBH4	25.37	10
3/8"	17/32"-24	62NBH6	35.02	10
1/2"	11/16"-20	62NBH8	34.76	10
5/8"	13/16"-18	62NBH10	99.82	10

Bulkhead Unions



Tube Size	Straight Thread	Part #	Price/E	Pkg Qty
1/4"	7/16"-24	62NFBH4	\$16.61	10
3/8"	17/32"-24	62NFBH6	37.55	10
1/2"	11/16"-20	62NFBH8	30.28	10
5/8"	13/16"-18	62NFBH10	45.62	10

Bulkhead Unions



Tube Size	Pipe Thread	Part #	Price/E	Pkg Qty
1/2"	3/8"	66NBH86	\$40.91	10

Female Elbows

Feature:

- ref. SAE 100203 BA



Tube Size	Pipe Thread	Straight Thread	Part #	Price/E	Pkg Qty
3/16"	1/8"	5/16"-24	70NAB32	\$62.65	25
1/4"	1/8"	7/16"-24	70NAB42	10.15	25
1/4"	1/4"	7/16"-24	70NAB44	14.13	25
3/8"	1/8"	17/32"-24	70NAB62	15.88	10
3/8"	1/4"	17/32"-24	70NAB64 ¹	10.05	10
3/8"	3/8"	17/32"-24	70NAB66	18.82	10
1/2"	3/8"	11/16"-20	70NAB86	25.55	10
1/2"	1/2"	11/16"-20	70NAB88	31.25	10
5/8"	1/2"	13/16"-18	70NAB108	58.11	10

¹ rounded elbow parts not as pictured

Male Elbows

Features:

- ref. SAE 100202 BA
- thread sealant may be white or burnt orange

Tube Size	Pipe Thread	Straight Thread	Part #	Price/E	Pkg Qty
3/16"	1/8"	5/16"-24	69NAB32VS	\$19.98	10
3/16"	1/4"	5/16"-24	69NAB34VS	29.00	10
1/4"	1/8"	7/16"-24	69NAB42VS	6.66	50
1/4"	1/4"	7/16"-24	69NAB44VS	8.10	50
1/4"	3/8"	7/16"-24	69NAB46VS	10.14	10
3/8"	1/8"	17/32"-24	69NAB62VS	9.77	10
3/8"	1/4"	17/32"-24	69NAB64VS	9.56	25
3/8"	3/8"	17/32"-24	69NAB66VS	9.94	25
3/8"	1/2"	17/32"-24	69NAB68VS	17.65	10
1/2"	1/4"	11/16"-20	69NAB84VS	14.71	10
1/2"	3/8"	11/16"-20	69NAB86VS	14.17	10
1/2"	1/2"	11/16"-20	69NAB88VS	17.80	10
5/8"	3/8"	13/16"-18	69NAB106VS	20.45	10
5/8"	1/2"	13/16"-18	69NAB108VS	22.14	5
3/4"	1/2"	1"-18	69NAB128VS	37.30	5
3/4"	3/4"	1"-18	69NAB1212VS	39.87	5



Union Elbows

Feature:

- ref. SAE 100201 BA

Tube Size	Straight Thread	Part #	Price/E	Pkg Qty
1/4"	7/16"-24	65NAB4	\$12.60	10
3/8"	17/32"-24	65NAB6	14.53	10
1/2"	11/16"-20	65NAB8	24.55	10
5/8"	13/16"-18	65NAB10	46.80	10



45° Elbows

Features:

- ref. SAE 100302 BA
- thread sealant may be white or burnt orange

Tube Size	Pipe Thread	Straight Thread	Part #	Price/E	Pkg Qty
1/4"	1/8"	7/16"-24	79NAB42VS	\$9.65	10
1/4"	1/4"	7/16"-24	79NAB44VS	10.80	10
3/8"	1/8"	17/32"-24	79NAB62VS	11.02	10
3/8"	1/4"	17/32"-24	79NAB64VS	10.20	10
3/8"	3/8"	17/32"-24	79NAB66VS	12.51	10
3/8"	1/2"	17/32"-24	79NAB68VS	17.66	10
1/2"	1/4"	11/16"-20	79NAB84VS	15.60	10
1/2"	3/8"	11/16"-20	79NAB86VS	16.00	10
1/2"	1/2"	11/16"-20	79NAB88VS	21.82	10
5/8"	3/8"	13/16"-18	79NAB106VS	28.95	5
5/8"	1/2"	13/16"-18	79NAB108VS	25.97	5
3/4"	1/2"	1"-18	79NAB128VS	37.79	2



Male Branch Tees

Features:

- ref. SAE 100425 BA
- thread sealant may be white or burnt orange



Tube Size	Pipe Thread	Straight Thread	Part #	Price/E	Pkg Qty
3/16"	1/8"	7/16"-24	72NAB32VS	\$117.40	10
1/4"	1/8"	7/16"-24	72NAB42VS	15.79	10
1/4"	1/4"	7/16"-24	72NAB44VS	15.79	10
3/8"	1/8"	17/32"-24	72NAB62VS	18.90	10
3/8"	1/4"	17/32"-24	72NAB64VS	17.46	10
3/8"	3/8"	17/32"-24	72NAB66VS	18.95	10
1/2"	1/4"	11/16"-20	72NAB84VS	25.34	10
1/2"	3/8"	11/16"-20	72NAB86VS	25.76	10
1/2"	1/2"	11/16"-20	72NAB88VS	32.20	10
5/8"	1/2"	13/16"-18	72NAB108VS	49.45	10

Union Tees

Feature:

- ref. SAE 100401 BA



Tube Size	Straight Thread	Part #	Price/E	Pkg Qty
1/4"	7/16"-24	64NAB4	\$16.02	25
3/8"	17/32"-24	64NAB6	17.76	10
1/2"	11/16"-20	64NAB8	31.35	10
5/8"	13/16"-18	64NAB10	49.25	10

Male Run Tees

Features:

- ref. SAE 100424 BA
- thread sealant may be white or burnt orange



Tube Size	Pipe Thread	Straight Thread	Part #	Price/E	Pkg Qty
1/4"	1/8"	7/16"-24	71NAB42VS	\$14.55	10
1/4"	1/4"	7/16"-24	71NAB44VS	19.13	10
3/8"	1/4"	17/32"-24	71NAB64VS	17.04	10
3/8"	3/8"	17/32"-24	71NAB66VS	21.60	10
1/2"	3/8"	11/16"-20	71NAB86VS	27.95	10
1/2"	1/2"	11/16"-20	71NAB88VS	35.96	10
5/8"	1/2"	13/16"-18	71NAB108VS	48.35	5

Sleeves

Feature:

- ref. SAE 100115



Tube Size	Part #	Price/E	Pkg Qty
3/16"	60NAB3	\$1.13	100
1/4"	60NAB4	0.60	100
3/8"	60NAB6	0.80	100
1/2"	60NAB8	0.92	100
5/8"	60NAB10	1.92	10
3/4"	60NAB12	2.50	50

Inserts

Feature:

- for SAE J844 tubing

Tube Size	302/304 Stainless Steel		
	Part #	Price/E	Pkg Qty
1/4"	63NAB4	\$0.94	200
3/8"	63NAB6	1.00	200
1/2"	63NAB8	1.11	100
5/8"	63NAB10	2.55	100
3/4"	63NAB12	4.16	100



Nuts

Feature:

- ref. SAE 100110

Tube Size	Male NPT	Part #	Price/E	Pkg Qty
3/16"	5/16"-24	61NAB3	\$3.60	100
1/4"	7/16"-24	61NAB4	1.29	100
3/8"	17/32"-24	61NAB6	1.80	100
1/2"	11/16"-20	61NAB8	3.40	50
5/8"	13/16"-18	61NAB10	5.56	25
3/4"	1"-18	61NAB12	8.10	25



Air Brake Fittings for Rubber Hose

Application:

- for use with SAEJ1402 air brake hose in making hose assemblies

Features:

- will meet D.O.T. FMVSS 571-106 standards when used with SAE J1402 Air Brake Hose
- working pressure: up to **225 PSI**
- temperature: **-50°F to 212°F (-46° to 100°C)**

Assembly Guide:

1. Slide nut onto hose
2. Slide sleeve onto hose with tapered edge toward fitting body
3. Firmly bottom the hose into fittings
4. Screw nut onto body until it contacts the fittings body's hex



Hose Springs

Hose Size	Length	Brass Alloy 360	
		Part #	Price/E
3/8"	2.70"	56RBSG-06	\$2.41
1/2"	2.70"	56RBSG-08	2.50



Spring Guard Nuts

Hose Size	Straight Thread	Brass Alloy 360	
		Part #	Price/E
3/8"	31/32"-20	61RBSG-06	\$5.90
1/2"	1-3/32-20	61RBSG-08	10.45



Hose Nut with Attached Springs



Hose Size	Length	Brass Alloy 360	
		Part #	Price/E
3/8"	3.55"	67RBSG-06	\$7.21
1/2"	3.50"	67RBSG-08	13.91

Male Connectors



Tube OD	Pipe Thread	Straight Thread	Hex	Brass Alloy 360	
				Part #	Price/E
3/8"	1/4"	31/32"-20	31/32"	68RB-0604B	\$7.05
3/8"	3/8"	31/32"-20	31/32"	68RB-0606B	7.32
3/8"	1/2"	31/32"-20	31/32"	68RB-0608B	9.40
1/2"	3/8"	1-3/32"-20	1-1/8"	68RB-0806B	14.00
1/2"	1/2"	1-3/32"-20	1-1/8"	68RB-0808B	16.85

Male Connector with Spring Guards



Hose Size	Pipe Thread	Hex	Brass Alloy 360	
			Part #	Price/E
3/8"	1/4"	1-1/16"	68RBSG-0604	\$16.06
3/8"	3/8"	1-1/16"	68RBSG-0606	16.70
3/8"	1/2"	1-1/16"	68RBSG-0608	17.95
1/2"	3/8"	1-1/4"	68RBSG-0806	29.15
1/2"	1/2"	1-1/4"	68RBSG-0808	30.55

Sleeves



Hose Size	Length	Brass Alloy 360	
		Part #	Price/E
3/8"	.64"	60RB-06	\$3.15
1/2"	.64"	60RB-08	3.72

Nuts



Hose Size	Thread	Hex	Brass Alloy 360	
			Part #	Price/E
3/8"	31/32"-20	1-1/32"	61RB-06	\$6.08
1/2"	1-3/32"-20	1-1/4"	61RB-08	9.82

Brass Push-In Fittings

Features:

- saves up to 75% of assembly time compared to the standard compression fittings
- quick connect: simply push tubing in, no tools required
- quick disconnect: hold two fingers on insert and pull tubing out, no tools required
- reusable: connect and disconnect numerous times
- full flow design provides up to 60% more flow than conventional fittings with internal tube supports
- positive seal: no leaks, after tubing is inserted, seal is made
- secure tube retention: pulling on tubing only serves to tighten the connection
- pre-applied PTFE based pipe sealant on all male pipe threads saves customer additional labor
- working pressure: fittings are suitable for use up to the maximum working pressure of the plastic tubing used also suitable for vacuum service
- temperature range: **-10°F to 200°F (-23°C to 93°C)**

Male Connectors

Tube OD	Male NPTF	Forged Brass		Optional Qty
		Part #	Price/E	
1/8"	10-32 ¹	684X10	\$10.70	20
1/8"	1/8"	684X4	7.70	20
5/32"	10-32 ¹	685X10	9.20	20
5/32"	1/8"	685X4	6.50	20
5/32"	1/4"	685X8	8.80	10
3/16"	10-32 ¹	686X10	10.40	20
3/16"	1/8"	686X4	8.75	20
1/4"	10-32 ¹	688X10	9.60	20
1/4"	1/8"	688X4	5.35	20
1/4"	1/4"	688X8	5.80	10
1/4"	3/8"	688X12	10.20	10
3/8"	1/8"	6812X4	7.70	10
3/8"	1/4"	6812X8	7.55	10
3/8"	3/8"	6812X12	8.70	10
3/8"	1/2"	6812X16	13.85	5
1/2"	1/4"	6816X8	12.40	5
1/2"	3/8"	6816X12	12.65	5
1/2"	1/2"	6816X16	16.10	5

¹ UNF - Straight thread, supplied with gasket



Female Connectors

Tube OD	Female NPTF	Forged Brass		Optional Qty
		Part #	Price/E	
1/8"	1/8"	664X4	\$17.40	10
5/32"	1/8"	665X4	14.35	10
1/4"	1/8"	668X4	10.00	10
1/4"	1/4"	668X8	13.00	10
3/8"	1/4"	6612X8	14.05	10
3/8"	3/8"	6612X12	19.00	5





Unions

Tube OD	Forged Brass		Optional Qty
	Part #	Price/E	
1/8"	624	\$9.00	20
5/32"	625	9.85	10
1/4"	628	9.00	10
3/8"	6212	11.00	10
1/2"	6216	14.30	5

Bulkhead Unions



Tube OD	Male NPT	Forged Brass		Optional Qty
		Part #	Price/E	
1/8"	7/16"-20	824	\$24.50	10
5/32"	7/16"-20	825	23.00	10
1/4"	1/2"-20	828	16.50	10
3/8"	3/4"-16	8212	23.00	5
1/2"	15/16"-16	8216	34.00	5

Male Elbows



Tube OD	Male NPTF	Forged Brass		Optional Qty
		Part #	Price/E	
1/8"	1/8"	694X4	\$7.45	10
5/32"	1/8"	695X4	7.25	10
3/16"	1/8"	696X4	7.90	10
1/4"	1/8"	698X4	6.75	10
1/4"	1/4"	698X8	7.75	10
1/4"	3/8"	698X12	12.75	10
3/8"	1/8"	6912X4	10.20	10
3/8"	1/4"	6912X8	10.55	10
3/8"	3/8"	6912X12	12.75	10
1/2"	1/4"	6916X8	14.45	5
1/2"	3/8"	6916X12	13.95	5

Female Elbows



Tube OD	Female NPTF	Forged Brass		Optional Qty
		Part #	Price/E	
5/32"	1/8"	705X4	\$7.80	10
1/4"	1/8"	708X4	8.90	10
1/4"	1/4"	708X8	11.50	5
3/8"	1/4"	7012X8	19.05	5

Union Elbows

Tube OD	Forged Brass		Optional Qty
	Part #	Price/E	
1/8"	654	\$9.80	10
5/32"	655	8.70	10
1/4"	658	9.65	10
3/8"	6512	13.50	10
1/2"	6516	20.80	5



Male Swivel Elbows

Tube OD	Male NPTF	Forged Brass		Optional Qty
		Part #	Price/E	
1/8"	1/8"	69S4X4	\$9.10	10
5/32"	10-32 ¹	69S5X10	10.35	10
5/32"	1/8"	69S5X4	9.60	10
5/32"	1/4"	69S5X8	11.45	10
1/4"	10-32 ¹	69S8X10	11.75	10
1/4"	1/8"	69S8X4	8.60	10
1/4"	1/4"	69S8X8	10.90	10
1/4"	3/8"	69S8X12	16.40	10
3/8"	1/8"	69S12X4	13.35	10
3/8"	1/4"	69S12X8	13.60	10
3/8"	3/8"	69S12X12	14.45	5
3/8"	1/2"	69S12X16	18.50	5
1/2"	3/8"	69S16X12	18.05	5
1/2"	1/2"	69S16X16	21.55	5



¹ UNF - Straight thread, supplied with gasket

Male Branch Tees

Tube OD	Male NPTF	Forged Brass		Optional Qty
		Part #	Price/E	
1/8"	1/8"	724X4	\$10.80	10
5/32"	1/8"	725X4	12.30	10
1/4"	1/8"	728X4	12.75	10
1/4"	1/4"	728X8	13.60	5
3/8"	1/8"	7212X4	16.10	5
3/8"	1/4"	7212X8	17.80	5
3/8"	3/8"	7212X12	19.50	5
1/2"	3/8"	7216X12	23.65	5



Union Tees

Tube OD	Forged Brass		Optional Qty
	Part #	Price/E	
1/8"	644	\$14.10	10
5/32"	645	11.80	10
3/16"	646	13.40	10
1/4"	648	13.40	10
3/8"	6412	18.00	5
1/2"	6416	27.75	5



Male Swivel Branch Tees



Tube OD	Male NPTF	Forged Brass		Optional Qty
		Part #	Price/E	
1/8"	1/8"	72S4X4	\$14.30	10
5/32"	1/8"	72S5X4	14.30	10
1/4"	1/8"	72S8X4	15.40	10
1/4"	1/4"	72S8X8	15.30	5
3/8"	1/4"	72S12X8	18.65	5
3/8"	3/8"	72S12X12	21.25	5
1/2"	3/8"	72S16X12	29.30	5
1/2"	1/2"	72S16X16	34.10	5

Male Run Tees



Tube OD	Male NPTF	Forged Brass		Optional Qty
		Part #	Price/E	
1/8"	1/8"	714X4	\$12.80	10
5/32"	1/8"	715X4	10.60	10
1/4"	1/8"	718X4	12.75	10
1/4"	1/4"	718X8	14.20	5
3/8"	1/8"	7112X4	16.80	5
3/8"	1/4"	7112X8	15.40	5
3/8"	3/8"	7112X12	18.90	5
1/2"	3/8"	7116X12	26.25	5

Male Swivel Run Tees



Tube OD	Male NPTF	Forged Brass		Optional Qty
		Part #	Price/E	
1/8"	1/8"	71S4X4	\$11.95	10
5/32"	10-32 ¹	71S5X10	20.10	10
5/32"	1/8"	71S5X4	13.60	5
1/4"	1/8"	71S8X4	14.45	5
1/4"	1/4"	71S8X8	15.30	5
3/8"	1/4"	71S12X8	18.90	5
3/8"	3/8"	71S12X12	19.95	5
1/2"	3/8"	71S16X12	30.25	5
1/2"	1/2"	71S16X16	33.95	5

¹ UNF - Straight thread, supplied with gasket.

Stainless Steel Legris Push-In Fittings

Applications:

Suitable for many industries such as: chemical, food, packaging and medical.

Features:

- temperature range: **-4°F to 245°F (-20°C to 118°C)**
- maximum operating pressure: **290 PSI**
- vacuum capability: 28" HG
- *Maximum circuit pressure depends equally on the type and diameter of the tube used.*
- materials conforming to FDA and 1934/2004 CE standards



Compatible with a range of tubes:

- semi-rigid nylon tube
- flexible polyurethane tube
- low density polyethylene
- PTFE tube FEP 140
- stainless steel and copper tube (when grooved)

Materials of Construction:

- body - AISI 316 stainless steel
- backup washer - 316L stainless steel
- collet - 303L stainless steel
- seal - FKM O-ring
- Thread sealant does not come pre-applied on male threads, allowing the appropriate sealant for the application to be applied by the user.
- silicone free

Straight Male Connectors

Tube OD	Male NPT	Stainless Steel		Pkg Qty
		Part #	Price/E	
1/4"	1/8"	38055611	\$58.05	10
1/4"	1/4"	38055614	61.15	10
3/8"	1/4"	38056014	72.55	10
3/8"	3/8"	38056018	77.70	10
1/2"	3/8"	38056218	98.35	10
1/2"	1/2"	38056222	104.55	10



- internal hex allows ease of assembly in tight places

Unions

Tube OD	Stainless Steel		Pkg Qty
	Part #	Price/E	
1/4"	38065600	\$70.70	10
3/8"	38066000	96.70	10
1/2"	38066200	124.95	10



Bulkhead Connectors Unions

Tube OD	Stainless Steel		Pkg Qty
	Part #	Price/E	
1/4"	38165600	\$142.75	10
3/8"	38166000	155.75	10
1/2"	38166200	242.00	10





Male Elbows

Tube OD	Male NPT	Stainless Steel		Pkg Qty
		Part #	Price/E	
1/4"	1/8"	38895611	\$86.40	10
1/4"	1/4"	38895614	96.70	10
3/8"	1/4"	38896014	155.40	10
3/8"	3/8"	38896018	161.50	10
1/2"	3/8"	38896218	196.75	10
1/2"	1/2"	38896222	199.75	10

- body is orientable for positioning purposes

Equal Elbow Unions



Tube OD	Stainless Steel		Pkg Qty
	Part #	Price/E	
1/4"	38025600	\$82.45	10

Union Tees



Tube OD	Stainless Steel		Pkg Qty
	Part #	Price/E	
1/4"	38045600	\$115.35	10
3/8"	38046000	183.25	10
1/2"	38046200	218.60	10



Nickel-Plated Brass Legris Push-In Fittings

Applications:

- Push-to-connect forged fittings are nickel plated and have an FKM seal making them suitable to use with liquids and gaseous fluids.
- Fittings are plated with a high phosphorous FDA nickel plate allowing them to be used in applications where exposure to harsh environments is present.
- applications include: food industry, packaging, robotics, pulp and paper and wash down

Features:

- FDA compliant
- temperature range: **-4°F to 302°F (-20°C to 150°C)**
- pressure range: up to **435 PSI**
- vacuum capability: 28" HG *maximum circuit pressure depends on media, temperature and diameter of tube used* 
- full flow
- excellent resistance to abrasion and corrosion
- silicone free
- available in fractional and metric sizes

Construction:

- body: high phosphorous FDA nickel plated brass
- back-up washer: high phosphorous FDA nickel plated brass
- collet: high phosphorous FDA nickel plated brass
- O-ring: FKM fluoroelastomer conforming to FDA standards
- base: high phosphorous FDA nickel plated brass
- thread sealant is intentionally left off product so the appropriate sealant for the application can be applied

Male Connectors

Tube OD	Male NPT	Nickel-plated Brass		Optional Qty
		Part #	Price/E	
5/32"	10-32 ¹	36010420	\$7.75	10
5/32"	1/8"	36750411	6.70	10
5/32"	1/4"	36750414	8.50	10
1/4"	10-32 ¹	36015620	9.50	10
1/4"	1/8"	36755611	5.90	10
1/4"	1/4"	36755614	6.30	10
1/4"	3/8"	36755618	8.65	10
3/8"	1/8"	36756011	13.10	10
3/8"	1/4"	36756014	11.00	10
3/8"	3/8"	36756018	12.45	10
3/8"	1/2"	36756022	16.40	10
1/2"	3/8"	36756218	16.50	10
1/2"	1/2"	36756222	16.25	10

¹ UNF - Straight thread, supplied with gasket and plastic button



Female Connectors

Tube OD	Female NPT	Nickel-plated Brass		Optional Qty
		Part #	Price/E	
5/32"	1/4"	36150414	\$13.60	10
1/4"	1/8"	36155611	8.85	10
1/4"	1/4"	36155614	15.55	10
3/8"	1/4"	36156014	18.05	10
3/8"	3/8"	36156018	22.00	10
1/2"	3/8"	36156218	21.90	10
1/2"	1/2"	36156222	22.65	10



Equal Unions

Tube OD	Nickel-plated Brass		Optional Qty
	Part #	Price/E	
5/32"	36060400	\$11.50	10
1/4"	36065600	8.65	10
3/8"	36066000	16.40	10
1/2"	36066200	19.90	10



Union Elbows



Tube OD	Nickel-plated Brass		Optional Qty
	Part #	Price/E	
5/32"	36020400	\$10.50	10
1/4"	36025600	9.25	10
3/8"	36026000	14.85	10
1/2"	36026200	19.90	10

Male Elbows



Tube OD	Male NPT	Nickel-plated Brass		Optional Qty
		Part #	Price/E	
5/32"	10-32 ¹	36990420	\$11.95	10
5/32"	1/8"	36090411	8.25	10
5/32"	1/4"	36090414	10.30	10
1/4"	1/8"	36095611	7.95	10
1/4"	1/4"	36095614	9.15	10
1/4"	3/8"	36095618	13.10	10
3/8"	1/4"	36096014	16.85	10
3/8"	3/8"	36096018	16.80	10
3/8"	1/2"	36096022	19.15	10
1/2"	1/2"	36096222	20.70	10

- ¹ UNF - Straight thread, supplied with gasket and plastic button
 • body is orientable for positioning purposes

Union Tees



Tube OD	Nickel-plated Brass		Optional Qty
	Part #	Price/E	
5/32"	36040400	\$13.90	10
1/4"	36045600	11.90	10
3/8"	36046000	17.90	10
1/2"	36046200	27.05	10

Male Run Tees



Tube OD	Male NPT	Nickel-plated Brass		Optional Qty
		Part #	Price/E	
5/32"	10-32 ¹	36930420	\$19.65	10
5/32"	1/8"	36030411	16.65	10
5/32"	1/4"	36030414	18.62	10
1/4"	1/8"	36035611	20.20	10
1/4"	1/4"	36035614	17.25	10
1/4"	3/8"	36035618	26.21	10
3/8"	1/4"	36036014	24.85	10
3/8"	3/8"	36036018	27.10	10

- ¹ UNF - Straight thread, supplied with gasket and plastic button
 • body is orientable for positioning purposes

Nylon/Nickel-Plated Brass Legris Push-In Fittings

Features:

- materials: nickel-plated brass threads; black body is glass-filled nylon; Buna-N D seal; polypropylene release button; silicone free
- positive seal: sealing and holding is accomplished instantaneously
- reusable: connect and disconnect numerous times
- full flow: fitting seals on outside diameter of tubing
- pre-applied thread sealant on all tapered male pipe threads
- compatible tubing: semi-rigid nylon, polyurethane and polyethylene tube
- working pressure: **290 PSI** at ambient temperature.
- *Maximum circuit pressure depends equally on the type and diameter of the tube used.* 
- temperature range: **-4°F to 175°F (-20°C to 79°C)**
- vacuum capability: vacuum of 28" Hg (99% vacuum)

Gripping Ring Technology



Quick Connect and Disconnect:

- To connect, simply push tubing in.
- To disconnect, press the release ring towards the fitting and pull tubing out.
- No tools required.

Male Connectors

Tube OD	Male NPT	Nylon / Nickel-plated Brass		Optional Qty
		Part #	Price/E	
1/8"	1/16"	31755308	\$8.05	10
1/8"	1/8"	31755311	5.35	10
1/8"	1/4"	31755314	8.65	10
5/32"	1/8"	31750411	4.10	10
5/32"	1/4"	31750414	9.25	10
1/4"	1/8"	31755611	4.85	10
1/4"	1/4"	31755614	4.85	10
1/4"	3/8"	31755618	6.85	10
5/16"	1/8"	31750811	9.00	10
5/16"	1/4"	31750814	9.00	10
5/16"	3/8"	31750818	10.10	10
3/8"	1/8"	31756011	9.75	10
3/8"	1/4"	31756014	7.00	10
3/8"	3/8"	31756018	8.65	10
3/8"	1/2"	31756022	12.80	10
1/2"	1/4"	31756214	12.95	10
1/2"	3/8"	31756218	12.90	10
1/2"	1/2"	31756222	14.00	10



Female Connectors

Tube OD	Female NPT	Nylon / Nickel-plated Brass		Optional Qty
		Part #	Price/E	
1/8"	1/8"	30145311	\$8.95	10
1/8"	1/4"	30145314	9.10	10
5/32"	1/8"	30140411	9.75	10
5/32"	1/4"	30140414	11.15	10
1/4"	1/8"	30145611	7.65	10
1/4"	1/4"	30145614	10.00	10
5/16"	1/8"	30140811	13.20	10
5/16"	1/4"	30140814	13.45	10
3/8"	1/8"	30146011	11.85	10
3/8"	1/4"	30146014	14.05	10
3/8"	3/8"	30146018	15.85	10



Hybrid Male Connectors

Tube OD	Male BSPT	Nylon / Nickel-plated Brass		Optional Qty
		Part #	Price/E	
1/4"	1/8"	31755610	\$9.00	10
1/4"	1/4"	31755613	9.65	10
3/8"	1/4"	31756013	13.75	10





Female Elbows

Tube OD	Female NPT	Nylon / Nickel-Plated Brass		Optional Qty
		Part #	Price/E	
1/8"	1/8"	30095311	\$10.25	10
5/32"	1/4"	30090414	13.60	10
1/4"	1/8"	30095611	6.65	10
1/4"	1/4"	30095614	10.05	10
5/16"	1/8"	30090811	13.95	10
5/16"	1/4"	30090814	14.05	10
3/8"	1/4"	30096014	12.90	10
1/2"	3/8"	30096218	18.20	10

Male Elbows

Tube OD	Male NPT	Nylon / Nickel Plated Brass		Optional Qty
		Part #	Price/E	
1/8"	10-32 ¹	31095320	\$8.60	10
1/8"	1/16"	31095308	11.80	10
1/8"	1/8"	31095311	6.00	10
1/8"	1/4"	31095314	8.70	10
5/32"	10-32 ¹	31090420	7.85	10
5/32"	1/8"	31090411	4.80	10
5/32"	1/4"	31090414	10.10	10
1/4"	10-32 ¹	31095620	9.95	10
1/4"	1/8"	31095611	5.40	10
1/4"	1/4"	31095614	5.95	10
1/4"	3/8"	31095618	8.00	10
5/16"	1/8"	31090811	10.70	10
5/16"	1/4"	31090814	10.70	10
5/16"	3/8"	31090818	11.35	10
3/8"	1/8"	31096011	9.10	10
3/8"	1/4"	31096014	8.05	10
3/8"	3/8"	31096018	9.10	10
3/8"	1/2"	31096022	13.65	10
1/2"	1/4"	31096214	10.60	10
1/2"	3/8"	31096218	13.05	10
1/2"	1/2"	31096222	14.85	10

- ¹ UNF - Straight thread, supplied with gasket
 • body is orientable for positioning purposes



45° Male Elbows

Tube OD	Male NPT	Nylon / Nickel Plated Brass		Optional Qty
		Part #	Price/E	
1/4"	1/8"	31135611	\$6.70	10
1/4"	1/4"	31135614	7.75	10
3/8"	1/4"	31136014	9.70	10
3/8"	3/8"	31136018	9.85	10

- body is orientable for positioning purposes



Extended Male Elbows

Tube OD	Male NPT	Nylon / Nickel Plated Brass		Optional Qty
		Part #	Price/E	
1/4"	1/8"	31295611	\$8.75	10
1/4"	1/4"	31295614	9.95	10
3/8"	1/4"	31296014	13.15	10
3/8"	3/8"	31296018	17.95	10

- body is orientable for positioning purposes



Male Branch Tees

Tube OD	Male NPT	Nylon / Nickel-Plated Brass		Optional Qty
		Part #	Price/E	
1/8"	10-32 ¹	31085320	\$14.60	10
1/8"	1/8"	31085311	9.35	10
5/32"	10-32 ¹	31080420	13.45	10
5/32"	1/8"	31080411	8.55	10
5/32"	1/4"	31080414	12.70	10
1/4"	1/8"	31085611	7.75	10
1/4"	1/4"	31085614	8.30	10
1/4"	3/8"	31085618	10.40	10
5/16"	1/8"	31080811	11.85	10
5/16"	1/4"	31080814	12.35	10
5/16"	3/8"	31080818	12.70	10
3/8"	1/8"	31086011	16.15	10
3/8"	1/4"	31086014	11.85	10
3/8"	3/8"	31086018	13.75	10
3/8"	1/2"	31086022	18.45	10
1/2"	1/4"	31086214	15.95	10
1/2"	3/8"	31086218	19.30	10
1/2"	1/2"	31086222	21.80	10



- ¹ UNF - Straight thread, supplied with gasket
- body is orientable for positioning purposes

Male Run Tees

Tube OD	Male NPT	Nylon / Nickel-Plated Brass		Optional Qty
		Part #	Price/E	
1/8"	10-32 ¹	31035320	\$14.70	10
1/8"	1/16"	31035308	15.25	10
1/8"	1/8"	31035311	9.60	10
5/32"	10-32 ¹	31030420	13.40	10
5/32"	1/8"	31030411	9.50	10
5/32"	1/4"	31030414	12.80	10
1/4"	1/8"	31035611	7.70	10
1/4"	1/4"	31035614	8.30	10
1/4"	3/8"	31035618	10.35	10
5/16"	1/8"	31030811	11.55	10
5/16"	1/4"	31030814	12.15	10
3/8"	1/8"	31036011	15.55	10
3/8"	1/4"	31036014	13.05	10
3/8"	3/8"	31036018	14.70	10
1/2"	1/4"	31036214	15.90	10
1/2"	3/8"	31036218	19.30	10
1/2"	1/2"	31036222	21.40	10



- ¹ UNF - Straight thread, supplied with gasket
- body is orientable for positioning purposes

Push-In Male Wyes

Tube OD	Male NPT	Nylon / Nickel Plated Brass		Optional Qty
		Part #	Price/E	
5/32"	1/8"	31480411	\$12.60	10
5/32"	1/4"	31480414	13.30	10
1/4"	1/8"	31485611	11.30	10
1/4"	1/4"	31485614	12.20	10



- body is orientable for positioning purposes

Nylon Legris Push-In Fittings



Unions

Tube OD	Part #	Price/E	Optional Qty
1/8"	31065300	\$6.75	10
5/32"	31060400	4.85	10
1/4"	31065600	5.40	10
5/16"	31060800	7.00	10
3/8"	31066000	7.95	10
1/2"	31066200	13.05	10

Bulkhead Unions



Tube OD	Part #	Price/E	Optional Qty
1/8"	31165300	\$8.75	10
5/32"	31160400	8.60	10
1/4"	31165600	9.10	10
5/16"	31160800	11.30	10
3/8"	31166000	13.50	10
1/2"	31166200	19.70	10

Union Elbows



Tube OD	Part #	Price/E	Optional Qty
1/8"	31025300	\$6.80	10
5/32"	31020400	5.50	10
1/4"	31025600	6.10	10
5/16"	31020800	7.30	10
3/8"	31026000	9.55	10
1/2"	31026200	12.85	10

Plugs



Tube OD	Part #	Price/E	Optional Qty
1/8"	31265300	\$1.85	10
5/32"	31260400	0.95	10
1/4"	31265600	2.25	10
5/16"	31260800	2.35	10
3/8"	31266000	3.35	10
1/2"	31266200	2.80	10

Union Tees



Tube OD	Part #	Price/E	Optional Qty
1/8"	31045300	\$9.50	10
5/32"	31040400	7.35	10
1/4"	31045600	8.20	10
5/16"	31040800	10.05	10
3/8"	31046000	11.40	10
1/2"	31046200	18.40	10

Tube Wyes



Tube OD	Part #	Price/E	Optional Qty
1/8"	31405300	\$7.65	10
5/32"	31400400	7.30	10
1/4"	31405600	8.05	10
5/16"	31400800	10.05	10
3/8"	31406000	14.65	10

Nylon / Nickel-Plated Brass Legris Push-In Fitting Kit

Features:

- kit includes plastic case with threaded connectors, threaded elbows and several tube to tube connector configurations found on pages F-151, F-152, F-154
- a tubing cutter is also included

Part #	Price/E
TFK	\$1159.00

Kit contains the following parts:

Part #	Qty	Description
31755311	10	tube to male NPT connector
31750411	10	tube to male NPT connector
31755611	10	tube to male NPT connector
31755614	10	tube to male NPT connector
31756014	5	tube to male NPT connector
31756018	5	tube to male NPT connector
31090411	10	tube to male NPT elbow
31095611	10	tube to male NPT elbow
31095614	10	tube to male NPT elbow
31096011	5	tube to male NPT elbow
31096014	5	tube to male NPT elbow
31096018	5	tube to male NPT elbow
31060400	10	tube to tube union
31065600	10	tube to tube union
31066000	5	tube to tube union
31400400	10	Y connector
31405600	10	Y connector
31406000	5	Y connector
31040400	10	tube to tube union tee
31045600	5	tube to tube union tee
31046000	5	tube to tube union tee
30007100	1	tubing cutter



Legris Modular Manifolds

Feature:

- manifold with push to connect ports

OD	NPT Size	Number of Outlets	Dimensions					Part #	Price/E
			A	B	C	D	E		
1/4"	1/4"	8	.55	1.30	4.92	4.53	.50	33155614	\$108.55

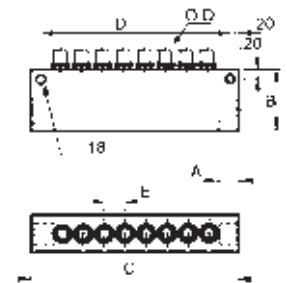

Legris Composite Mini Ball Valves

Application:

- valves enable in-line opening and closing of a pneumatic circuit

Features:

- 2-way, non-venting valve
- compact and lightweight, suited to all types of installation
- suitable fluid: compressed air
- maximum operating pressure: **145 PSI**
- vacuum rating: vacuum of 28" Hg (99% of vacuum)
- temperature range: **-4°F to 175°F (-20°C to 79°C)**
- nylon body with nickel-plated brass ball
- a screwdriver slot allows opening and closing even when access is difficult
- handle is differentiated by a blue color and marked with the corresponding pneumatic symbol enabling immediate identification by the user



Size	Part #	Price/E
5/32"	79100400	\$48.90
1/4"	79105600	37.70
5/16"	79100800	45.80
3/8"	79106000	46.30

Legris Quick Exhaust Valves

Application:

- can be used with all pneumatic equipment

Features:

- increases system efficiency and the speed of a cylinder by purging cylinder air at the cylinder port rather than the control valve
- pressure range: **10 PSI to 150 PSI**
- temperature range: **0°F to 160°F (-17°C to 71°C)**
- body: nickel-plated brass
- piston: polyurethane
- seals: nylon



NPT Thread	Part #	Price/E
1/8"	79821111	\$17.80
1/4"	79821414	20.10
3/8"	79821818	30.05
1/2"	79822222	40.95

Legris Compact Flow Control Valves

Features:

- Valves control the speed of a cylinder by regulating air exhaust. Intake air flows freely through the flow control and exhaust air is metered out through a specially designed fine adjustment screw.
- push-to connect, meter out flow control, one-piece design
- body: nylon
- control pressure range: **15 PSI to 145 PSI**
- temperature range: **32°F to 158°F (0°C to 70°C)**



Tube OD	NPT Size	Part #	Price/E	Pkg Qty
5/32"	1/8"	70650411	\$25.90	10
1/4"	1/8"	70655611	28.55	10
1/4"	1/4"	70655614	31.30	10
3/8"	1/4"	70656014	51.85	10
3/8"	3/8"	70656018	62.25	10

Legris Miniature Exhaust Flow Control Valves

Features:

- Valves control the speed of a cylinder by regulating air exhaust. Intake air flows freely through the flow control and exhaust air is metered out through a specially designed fine adjustment screw.
- push-to connect, meter out flow control, one-piece design.
- body: nylon
- control pressure range: **15 PSI to 145 PSI**
- temperature range: **30°F to 158°F (-1°C to 70°C)**



Tube OD	NPT Size	Part #	Price/E	Pkg Qty
5/32"	10-32 ¹	76600420	\$23.50	10
5/32"	1/8"	76650411	23.60	10
1/4"	10-32 ¹	76605620	28.40	10
1/4"	1/8"	76655611	28.35	10
1/4"	1/4"	76655614	28.40	10

¹ UNF - Straight thread, supplied with gasket

Legris In-Line Flow Control Valves

Application:

- used where cylinder access is difficult or another fitting is attached to the cylinder port

Features:

- working fluid: compressed air
- pressure range: **15 PSI to 145 PSI**
- temperature range: **32°F to 158°F (0°C to 70°C)**
- stackable using the 2 joining clips supplied or panel mountable using existing holes
- body: nylon
- gripping ring: stainless steel
- adjustment screw: nickel-plated brass
- locking nut: nickel-plated brass



Tube OD	Part #	Price/E	Pkg Qty
5/32"	77700400	\$44.00	10
1/4"	77705600	46.50	10
3/8"	77706000	71.35	10
1/2"	77706200	82.90	10



Legris Threaded In-Line Flow Control Valves

Features:

- intake air flows freely through the flow control; exhaust air is metered out through an adjustment screw
- arrow on the body of the valve indicates the direction of controlled flow
- may be installed as meter in or meter out devices
- unidirectional flow control valves
- working fluid: compressed air
- pressure range: **15 PSI to 145 PSI**
- temperature range: **32°F to 158°F (0°C to 70°C)**
- body: nylon with nickel plated brass thread
- adjustment screw: nickel-plated brass
- locking nut: nickel-plated brass
- threads: nickel-plated brass



Female NPT	Part #	Price/E
1/8"	77751111	\$46.35
1/4"	77751414	51.05
3/8"	77751818	69.95
1/2"	77752222	91.45



Legris Non-Return In-Line Check Valves

Features:

- allows air to pass in one direction while blocking flow in the other direction, a pressure of more than 7 PSI will overcome the spring pressure and allow flow
- arrow indicates free flow direction
- body: nylon/nickel plated brass
- maximum operating pressure: **145 PSI** at ambient temperature **70°F (21°C)**

Tube OD	Part #	Price/E	Pkg Qty
5/32"	79960400	\$28.35	10
6mm	79960600	30.35	10
1/4"	79965600	31.55	10
5/16"	79960800	36.30	10

Legris In-Line Check Valves

Application:

- suitable as a safety item in compressed air circuits

Features:

- compact, lightweight design meter out check valves
- allows air to pass in one direction while blocking flow in the other direction
- arrow on body of the fitting indicates direction of flow, a pressure of more than 7 PSI will overcome spring pressure keeping the valve closed, thus allowing the passage of air
- pressure range: **15 PSI** to **145 PSI** at ambient temperature **70°F (21°C)**
- body: nylon with nickel plated brass base
- pre-applied thread sealant on tapered threads



Tube OD	NPT Size	Part #	Price/E
5/32"	10-32 ¹	79940420	\$32.75
5/32"	1/8"	79950411	27.75
1/4"	1/8"	79955611	31.05
1/4"	1/4"	79955614	31.55
3/8"	1/4"	79956014	38.75
3/8"	3/8"	79956018	43.85

¹ UNF - Straight thread, supplied with gasket

Legris Uni-Directional Check Valves

Features:

- blocks the fluid passage when the pressure differential is lower than 3.6 PSI
- pressure range: **7 PSI** to **580 PSI**
- temperature range: **-4°F** to **356°F (-20° to 180°C)**
- body: 316L stainless steel
- shut-off valve: 316L stainless steel
- return spring: 302 stainless steel
- seals: FKM



NPT Thread	Part #	Price/E
1/8"	48951111	\$188.70
1/4"	48951414	188.70
3/8"	48951818	241.70
1/2"	48952222	227.60

Legris Metric Push-In Fittings

Features:

- materials: nickel-plated brass, black glass-filled nylon body, Buna-N D-seal, polypropylene release button, silicone free and nylon nickel plated brass or nylon
- positive seal: sealing and holding is accomplished instantaneously
- reusable: connect and disconnect numerous times
- full flow: fitting seals on outside diameter of tubing
- pressure rating: **290 PSI** at ambient temperature
- temperature range: **-4°F to 175°F (-20°C to 79°C)**
- pre-applied thread sealant on all tapered male pipe threads
- compatible tubing: semi-rigid nylon, polyurethane and polyethylene tube
- vacuum rating: vacuum of 28" Hg (99% vacuum)

Gripping Ring Technology



Quick Connect and Disconnect:

- to connect: simply push tubing in
- to disconnect: press the release ring towards the fitting and pull tubing out
- no tools required

Male BSPT Connectors

Tube OD	Male BSPT	Nickel Plated Brass		Pkg Qty
		Part #	Price/E	
4 mm	1/8"	31750410	\$5.00	10
4 mm	1/4"	31750413	8.00	10
6 mm	1/8"	31750610	6.05	10
6 mm	1/4"	31750613	6.90	10
8 mm	1/8"	31750810	8.20	10
8 mm	1/4"	31750813	8.20	10
8 mm	3/8"	31750817	10.05	10
10 mm	1/4"	31751013	10.80	10
10 mm	3/8"	31751017	12.15	10



- internal hex allows ease of assembly in tight places

Female BSPP Connectors

Tube OD	Female BSPP	Nickel Plated Brass		Pkg Qty
		Part #	Price/E	
4 mm	1/8"	31140410	\$9.00	10
4 mm	1/4"	31140413	11.50	10
6 mm	1/8"	31140610	8.60	10
6 mm	1/4"	31140613	10.45	10
8 mm	1/8"	31140810	10.90	10
8 mm	1/4"	31140813	10.30	10



Male BSPT Elbows

Tube OD	Male BSPT	Nylon/Nickel Plated Brass		Pkg Qty
		Part #	Price/E	
4 mm	1/8"	31090410	\$6.55	10
4 mm	1/4"	31090413	10.15	10
6 mm	1/8"	31090610	7.05	10
6 mm	1/4"	31090613	7.70	10
8 mm	1/8"	31090810	10.35	10
8 mm	1/4"	31090813	10.35	10
8 mm	3/8"	31090817	11.60	10
10 mm	1/4"	31091013	16.40	10
10 mm	3/8"	31091017	16.30	10



- body is orientable for positioning purposes



Male Branch Tees

Tube OD	Male BSPT	Nylon / Nickel Plated Brass		Pkg Qty
		Part #	Price/E	
4 mm	1/8"	31080410	\$9.35	10
4 mm	1/4"	31080413	13.80	10
6 mm	1/8"	31080610	9.95	10
6 mm	1/4"	31080613	10.15	10
8 mm	1/8"	31080810	12.60	10
8 mm	1/4"	31080813	13.10	10

- body is orientable for positioning purposes

Nylon Tubing

Features:

- translucent color
- resistant to fungus, abrasion, moisture and UV
- temperature range: **-60°F to 200°F (-51°C to 93°C)**



OD	Size		Wall Thickness	Working Pressure @ 75°F (24°C)	Length	Part #	Price/Length
	ID						
4 mm	2.7 mm		.65 mm	350	25 m	1025P0400	\$40.75
6 mm	4 mm		1 mm	340	25 m	1025P0600	86.00
8 mm	6 mm		1 mm	250	25 m	1025P0800	124.00

Tubing cutters sold on page L-36

Male Threaded Connectors

Feature:

- internal hex allows ease of assembly in tight places



Tube OD	Male Thread	Nickel Plated Brass		Pkg Qty
		Part #	Price/E	
4 mm	M5	31010419	\$7.00	10
4 mm	1/8 BSPP	31010410	6.10	10
6 mm	M5	31010619	9.85	10
6 mm	1/8 BSPP	31010610	6.75	10
6 mm	1/4 BSPP	31010613	7.65	10
8 mm	1/8 BSPP	31010810	8.50	10
8 mm	1/4 BSPP	31010813	9.30	10
10 mm	1/4 BSPP	31011013	15.25	10

Bulkhead Union



Tube OD	Tube OD	Nylon		Pkg Qty
		Part #	Price/E	
6 mm	6 mm	31160600	\$9.90	10

Unions



Tube OD	Tube OD	Nylon		Pkg Qty
		Part #	Price/E	
4 mm	6 mm	31060406	\$10.80	10
6 mm	6 mm	31060600	6.20	10
10 mm	10 mm	31061000	15.65	10

Male Elbows

Tube OD	Male Thread	Nylon / Nickel Plated Brass		Pkg Qty
		Part #	Price/E	
4 mm	M5	31990419	\$7.30	10
4 mm	1/8 BSPP	31990410	7.85	10
6 mm	M5	31990619	7.85	10
6 mm	1/8 BSPP	31990610	7.95	10
6 mm	1/4 BSPP	31990613	10.75	10
8 mm	1/8 BSPP	31990810	12.20	10
8 mm	1/4 BSPP	31990813	12.20	10
10 mm	1/4 BSPP	31991013	16.80	10



- body is orientable for positioning purposes

Union Elbows

Tube OD	Tube OD	Nylon		Pkg Qty
		Part #	Price/E	
6 mm	6 mm	31020600	\$7.45	10
10 mm	10 mm	31021000	14.90	10



Union Tees

Tube OD	Nylon		Pkg Qty
	Part #	Price/E	
6 mm	31040600	\$9.10	10
10 mm	31041000	21.90	10



Y Connector

Tube OD	Tube OD	Nylon		Pkg Qty
		Part #	Price/E	
6 mm	6 mm	31400600	\$9.10	10



Plugs

Tube OD	Tube OD	Plastic		Pkg Qty
		Part #	Price/E	
6 mm	6 mm	31260600	\$2.30	10
10 mm	10 mm	31261000	4.75	10



Ball Swivels

**Features:**

- brass and hardened steel construction
- O-ring seals
- wobble action for increased flexibility with air driven tools

Hose Size	Male NPT	Part #	Price/E	Optional Qty
1/4"	1/4"	D444S	\$21.15	25
3/8"	1/4"	D446S	15.60	25

Push-On Ball Swivels

**Feature:**

- special barb design for secure grip in push-on type air hoses

Hose Size	Male NPT	Part #	Price/E	Optional Qty
3/8"	1/4"	D446SL	\$17.20	25

In-Line Swivels

Features:

- for air service only 
- rated to **250 PSI** at ambient temperature **70°F (21°C)**, minimum **35 PSI**
- heavy-duty, free turning steel swivel



Male NPT	Female NPT	Part #	<i>Steel</i> Price/E
3/8"	1/2"	SV17	\$73.75
1/2"	1/2"	SV20	74.10
3/4"	3/4"	SV26	75.60

Features:

- for air service only 
- rated to **150 PSI** at ambient temperature **70°F (21°C)**



Male NPT	Female NPT	Part #	<i>Brass</i> Price/E
1/4"	1/4"	D344R	\$10.50
3/8"	3/8"	D366R	22.75

Breather Vents

Applications:

- used on single acting cylinders or valves to prevent dirt and foreign particles from entering ports open to the atmosphere
- provides vacuum relief or pressure equalization on gear boxes, oil tanks or reservoirs

Features:

- standard pipe thread connections for quick assembly and removal for cleaning
- nickel plated steel insert with a bronze filter
- 40 micron filter element
- maximum operating pressure: **150 PSI**
- temperature range: **35°F to 300°F (1.7°C to 149°C)**



NPT Thread	Overall Length	Nickel Plated Steel	
		Part #	Price/E
1/8"	7/16"	ASP-1BV	\$2.50
1/4"	5/8"	ASP-2BV	2.60
3/8"	3/4"	ASP-3BV	3.75
1/2"	7/8"	ASP-4BV	5.50
3/4"	1"	ASP-6BV	8.90
1"	1-5/16"	ASP-8BV	17.20

Conical Mufflers

Application:

- threads into the exhaust ports of air tool, valves, cylinders and other pneumatic equipment

Features:

- reduces noise levels below 90 dBA to conform with OSHA standards
- 40 micron bronze filter element
- element is bonded directly to the fitting and *is not replaceable*
- maximum operating pressure: **300 PSI**
- temperature range: **35°F to 300°F (2°C to 149°C)**



NPT Thread	Overall Length	Nickel Plated Steel	
		Part #	Price/E
1/8"	1 1/8"	CMF18	\$3.60
1/4"	1 3/8"	CMF28	4.30
3/8"	1 1/2"	CMF38	5.60
1/2"	1 7/8"	CMF48	8.65
3/4"	2 1/4"	CMF68	14.30
1"	2 7/8"	CMF88	20.50



aluminum

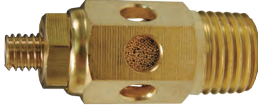

brass

Speed Control Mufflers

Features:

- maximum operating pressure: **300 PSI**
- temperature range: **35°F to 300°F (2°C to 149°C)**
- safe and infinite variations of metering air flow at acceptable sound levels on exhaust ports of air valves
- speed of operating cylinder or air tool may be increased or decreased with adjusting screw, the final position is locked in place by the lock nut
- exhaust air noise is eliminated by a surrounding sleeve of sintered bronze

NPT Thread	Approximate Full Oper. Height	Maximum Adjusted SCFM	Brass	
			Part #	Price/E
1/8"	1-5/16"	20	SCM18	\$6.55
1/4"	1-9/16"	30	SCM28	7.55
3/8"	1 5/8"	40	SCM38	10.90
1/2"	2"	60	SCM48	16.90
3/4"	2 3/8"	70	SCM68	22.50
1"	2 1/2"	100	SCM88	41.00



Quick Disconnects H-2 to H-54

H-series	H-2 to H-8
Flush Face / HT-series	H-9 to H-11
HTE-series.....	H-13
HS series.....	H-14
V-series Snap-Tite H / IH.....	H-15 to H-23
K-series	H-24, H-25
AH-series.....	H-26, H-27
CM-series	H-28 to H-31
PD-series.....	H-32
ST-series Snap-Tite 71	H-33 to H-35
H-BOP series.....	H-36
E-series	H-37 to H-39
EA-series.....	H-40
W-series	H-41 to H-43
WS-series	H-44, H-45
WS-BOP series	H-46
VEP-series.....	H-47, H-48
VEP-BOP series	H-49
T-series.....	H-50, H-51
TR-series	H-52
CVV-series.....	H-53, H-54

Adapters..... H-55 to H-75

Flat Face.....	H-55, H-56
Unions.....	H-55
Connectors.....	H-55
90° elbows	H-55, H-56
Tees	H-56
Caps.....	H-56
Plugs.....	H-56
ORB.....	H-57 to H-59
Reducers.....	H-57
Unions.....	H-57
O-ring Boss	H-57 to H-59
Elbows	H-58, H-59
Tees	H-59
Plugs.....	H-59
JIC	H-60 to H-66
37° flare	H-60
37° JIC swivel	H-61
90° JIC elbows.....	H-61
90°, 37° flare elbows.....	H-62
45°, 37° elbows.....	H-62, H-63
37° flare unions.....	H-63
37° flare tees.....	H-63
Caps.....	H-64
Nuts.....	H-64, H-65
Plugs.....	H-64
Sleeves.....	H-64

Adapters (cont.) H-55 to H-75

JIC (cont.).....	H-60 to H-66
Straight weld end	H-66
45° elbow weld end.....	H-66
90° elbow weld end.....	H-66
NPTF	H-67 to H-71
Pipe nipples	H-67
Hex reducer bushings.....	H-67
Swivel nuts.....	H-68
Hex pipe couplings.....	H-68
90° elbows	H-68, H-69
45° elbows	H-69
Tees	H-70
Hex caps.....	H-71
Hex plugs.....	H-71
Metric parallel thread	H-71
BSPP	H-72
Code 61 / 62 flanges	H-73 to H-75
4-bolt NPTF port	H-73
4-bolt SAE port.....	H-73
4-bolt flange pipe socket weld.....	H-74
Split flange kits.....	H-75
Straight SAE	H-75
90° SAE elbow	H-75
45° SAE elbows	H-75

Hydraulic Hose Fittings H-76

Hose couplings.....	H-76
Hose stems.....	H-76
Inline hydraulic filters.....	H-76

PTFE Hose Fittings H-77 to H-79

Nominal fittings.....	H-77
Nominal insertion tool and dies	H-77
Nominal smooth bore PTFE hose fittings.....	H-78
True ID fittings	H-78, H-79
Crimp collars.....	H-79

Pipe and Tubing Hangers....H-80 to H-81

Standard series	H-80
Twin series.....	H-80
Heavy duty series.....	H-81



H-Series Hydraulic Couplings

Features:

- poppet style shut-off valves in both coupler and plug
- designed to prevent fluid loss when disconnected
- meets dimensional requirements of **ISO 7241 Series B**
- interchangeable with Parker-Hannifin 60 series, see Hydraulic Profile Chart on page H-6
- Buna-N seals standards. Contact Dixon® for additional seal material options.
- Contact Dixon® for pressure ratings and other technical information.

H-Series ISO-B Industrial Interchange Poppet Valve Female Threaded Couplers



steel



brass



303 stainless

Body Size	Threads	Previous Part #	Steel		Previous Part #	Brass	
			Part #	Price/E		Part #	Price/E
1/8"	1/8" - 27 NPTF	---	1HF1	\$24.33	---	1HF1-B	\$24.19
	7/16" - 20 ORB	---	1HOF2	30.12	---	---	---
1/4"	1/4" - 18 NPTF	16-263	2HF2	23.16	B16-263	2HF2-B	22.51
	1/4" - 19 BSPP	---	2HBF2	25.48	---	2HBF2-B	24.76
	9/16" - 18 ORB	---	2HOF3	27.80	---	---	---
3/8"	3/8" - 18 NPTF	16-363	3HF3	28.95	B16-363	3HF3-B	31.29
	3/8" - 19 BSPP	---	3HBF3	33.30	---	3HBF3-B	36.02
	3/4" - 16 ORB	---	3HOF4	37.65	---	---	---
1/2"	1/2" - 14 NPTF	16-463	4HF4	36.48	B16-463	4HF4-B	41.08
	1/2" - 14 BSPP	---	4HBF4	45.38	---	4HBF4-B	47.66
	7/8" - 14 ORB	---	4HOF5	48.65	---	---	---
3/4"	3/4" - 14 NPTF	16-663	6HF6	58.75	B16-663	6HF6-B	80.03
	3/4" - 14 BSPP	---	6HBF6	69.49	---	6HBF6-B	87.79
	1-1/16" - 12 ORB	---	6HOF6	75.20	---	---	---
1"	1" - 11 1/2 NPTF	16-863	8HF8	97.08	B16-863	8HF8-B	110.20
	1" - 11 BSPP	---	8HBF8	97.08	---	8HBF8-B	110.20
	1-5/16" - 12 ORB	---	8HOF8	110.03	---	---	---

Body Size	Threads	Previous Part #	303 Stainless Steel		316 Stainless Steel	
			Part #	Price/E	Part #	Price/E
1/8"	1/8" - 27 NPTF	---	1HF1-S	\$72.39	1HF1-SS	\$134.75
1/4"	1/4" - 18 NPTF	SS16-263	2HF2-S	62.72	2HF2-SS	150.98
	1/4" - 19 BSPP	---	2HBF2-S	62.72	2HBF2-SS	150.98
3/8"	3/8" - 18 NPTF	SS16-363	3HF3-S	88.13	3HF3-SS	201.61
	3/8" - 19 BSPP	---	3HBF3-S	88.13	3HBF3-SS	201.61
1/2"	1/2" - 14 NPTF	SS16-463	4HF4-S	144.79	4HF4-SS	282.72
	1/2" - 14 BSPP	---	4HBF4-S	144.79	4HBF4-SS	318.81
3/4"	3/4" - 14 NPTF	SS16-663	6HF6-S	227.26	6HF6-SS	427.09
	3/4" - 14 BSPP	---	6HBF6-S	227.26	6HBF6-SS	504.53
1"	1" - 11 1/2 NPTF	SS16-863	8HF8-S	362.87	8HF8-SS	649.66
	1" - 11 BSPP	---	8HBF8-S	362.87	8HBF8-SS	649.66

H-Series ISO-B Industrial Interchange Female Threaded Plugs

Hydraulic Fittings

Body Size	Threads	Previous Part #	Steel		Previous Part #	Brass	
			Part #	Price/E		Part #	Price/E
1/8"	1/8" - 27 NPTF	---	H1F1	\$9.85	---	H1F1-B	\$9.57
	7/16" - 20 ORB	---	H1OF2	12.16	---	---	---
1/4"	1/4" - 18 NPTF	17-263	H2F2	10.95	B17-263	H2F2-B	10.64
	1/4" - 19 BSPP	---	H2BF2	12.74	---	H2BF2-B	12.38
	9/16" - 18 ORB	---	H2OF3	12.98	---	---	---
3/8"	3/8" - 18 NPTF	17-363	H3F3	13.20	B17-363	H3F3-B	15.76
	3/8" - 19 BSPP	---	H3BF3	16.68	---	H3BF3-B	19.14
	3/4" - 16 ORB	---	H3OF4	22.01	---	---	---
1/2"	1/2" - 14 NPTF	17-463	H4F4	14.36	B17-463	H4F4-B	18.57
	1/2" - 14 BSPP	---	H4BF4	18.44	---	H4BF4-B	18.57
	7/8" - 14 ORB	---	H4OF5	24.33	---	---	---
3/4"	3/4" - 14 NPTF	17-663	H6F6	28.38	B17-663	H6F6-B	31.58
	3/4" - 14 BSPP	---	H6BF6	33.59	---	H6BF6-B	36.98
	1-1/16" - 12 ORB	---	H6OF6	37.07	---	---	---
1"	1" - 11 1/2 NPTF	17-863	H8F8	40.54	B17-863	H8F8-B	48.40
	1" - 11 BSPP	---	H8BF8	44.01	---	H8BF8-B	51.78
	1-5/16" - 12 ORB	---	H8OF8	67.76	---	---	---



steel



brass

Body Size	Threads	Previous Part #	303 Stainless Steel		316 Stainless Steel	
			Part #	Price/E	Part #	Price/E
1/8"	1/8" - 27 NPTF	---	H1F1-S	\$23.16	H1F1-SS	\$57.75
1/4"	1/4" - 18 NPTF	SS17-263	H2F2-S	26.14	H2F2-SS	69.34
	1/4" - 19 BSPP	---	H2BF2-S	26.14	H2BF2-SS	69.34
3/8"	3/8" - 18 NPTF	SS17-363	H3F3-S	42.95	H3F3-SS	102.32
	3/8" - 19 BSPP	---	H3BF3-S	42.95	H3BF3-SS	102.32
1/2"	1/2" - 14 NPTF	SS17-463	H4F4-S	68.05	H4F4-SS	132.33
	1/2" - 14 BSPP	---	H4BF4-S	70.08	H4BF4-SS	149.03
3/4"	3/4" - 14 NPTF	SS17-663	H6F6-S	103.67	H6F6-SS	186.47
	3/4" - 14 BSPP	---	H6BF6-S	103.67	H6BF6-SS	250.45
1"	1" - 11 1/2 NPTF	SS17-863	H8F8-S	164.21	H8F8-SS	294.75
	1" - 11 BSPP	---	H8BF8-S	179.54	H8BF8-SS	358.51



303 stainless

H-Series ISO-B Industrial Interchange Male Threaded Plugs

Body Size	Threads	Steel	
		Part #	Price/E
1/4"	3/8" - 18 NPTF	H2M3	\$14.96



Body Size	Threads	303 Stainless Steel	
		Part #	Price/E
1/2"	3/4" - 14 NPTF	H4M6-S	\$100.65



H-Series ISO-B Industrial Interchange High Volume Female Threaded Couplers

Hydraulic Fittings



steel



brass



316 stainless

Body Size	Threads	Steel		Brass		303 Stainless Steel		316 Stainless Steel	
		Part #	Price/E	Part #	Price/E	Part #	Price/E	Part #	Price/E
1½"	1¼" - 11½ NPTF	10HF10	\$452.45	10HF10-B	\$360.40	10HF10-S	\$866.73	---	---
	1¼" - 11 BSPP	10HBF10	463.31	---	---	---	---	---	---
1½"	1¼" - 11½ NPTF	12HF10	434.84	12HF10-B	545.87	12HF10-S	1338.98	---	---
	1½" - 12 ORB	12HOF10	517.07	---	---	---	---	---	---
	1½" - 11½ NPTF	12HF12	434.84	12HF12-B	438.94	12HF12-S	1216.20	12HF12-SS	\$2647.44
	1½" - 11 BSPP	12HBF12	422.17	12HBF12-B	529.98	12HBF12-S	1338.98	12HBF12-SS	2647.45
2½"	1½" - 12 ORB	12HOF12	517.07	---	---	---	---	---	---
	2" - 11½ NPTF	20HF16	1162.51	20HF16-B	1064.66	---	---	---	---
2½"	2½" - 8 NPTF	20HF20	1156.51	---	---	---	---	---	---
	3" - 8 NPTF	20HF24	1213.41	---	---	---	---	---	---

H-Series ISO-B Industrial Interchange High Volume Female Threaded Plugs



steel



brass



303 stainless

Body Size	Threads	Steel		Brass		303 Stainless Steel		316 Stainless Steel	
		Part #	Price/E	Part #	Price/E	Part #	Price/E	Part #	Price/E
1½"	1¼" - 11½ NPTF	H10F10	\$329.04	H10F10-B	\$268.86	H10F10-S	\$675.78	---	---
	1¼" - 11 BSPP	H10BF10	376.44	---	---	---	---	---	---
1½"	1¼" - 11½ NPTF	H12F10	370.66	H12F10-B	335.40	H12F10-S	926.63	---	---
	1½" - 12 ORB	H12OF10	368.79	---	---	---	---	---	---
	1½" - 11½ NPTF	H12F12	370.66	H12F12-B	335.40	H12F12-S	926.63	H12F12-SS	\$1788.09
	1½" - 11 BSPP	H12BF12	380.19	H12BF12-B	335.40	H12BF12-S	926.63	H12BF12-SS	1788.09
2½"	1½" - 12 ORB	H12OF12	368.79	---	---	---	---	---	---
	2" - 11½ NPTF	H20F16	918.41	H20F16-B	806.71	---	---	---	---
2½"	2½" - 8 NPTF	H20F20	907.25	---	---	---	---	---	---
	3" - 8 NPTF	H20F24	957.65	---	---	---	---	---	---

H-Series ISO-B Industrial Interchange Steel Mill 'Slide Gate' Coupler

Body Size	Female Threads	Steel	
		Part #	Price/E
1/2"	1/2" - 14 NPTF	4HF4-HV	\$58.89



H-Series ISO-B Industrial Interchange Steel Mill 'Slide Gate' Plug

Body Size	Female Threads	Steel	
		Part #	Price/E
1/2"	1/2" - 14 NPTF	H4F4-HV	\$23.49



H-Series ISO-B Industrial Interchange Food Grade Silicone Flanged Couplers

Body Size	Female Threads	303 Stainless Steel		316 Stainless Steel	
		Part #	Price/E	Part #	Price/E
1/2"	1/2" - 14 NPTF	D-4HF4-S-FSB	\$155.57	D-4HF4-SS-FSB	\$309.71



H-Series ISO-B Industrial Interchange Food Grade Nylon Flanged Couplers

Body Size	Female Threads	303 Stainless Steel		316 Stainless Steel	
		Part #	Price/E	Part #	Price/E
1/2"	1/2" - 14 NPTF	D-4HF4-S-FNS	\$157.54	D-4HF4-SS-FNS	\$295.77

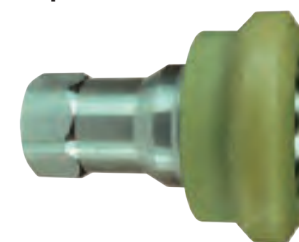

H-Series ISO-B Industrial Interchange Food Grade Plugs

Body Size	Female Threads	Steel		303 Stainless Steel		316 Stainless Steel	
		Part #	Price/E	Part #	Price/E	Part #	Price/E
1/2"	1/2" - 14 NPTF	D-H4F4-SV-8	\$31.36	D-H4F4-S	\$70.09	D-H4F4-SS	\$136.33



H-Series ISO-B Industrial Interchange Dust Caps / Plugs



Body Size	Previous Part #		Part #	Price/E
	Plugs	Caps		
1/8"	VHC002	---	1HDP	\$3.16
1/8"	---	---	H1DC	3.16
1/4"	16-002	17-002	2HDP-H2DC	3.16
3/8"	16-003	17-003	3HDP-H3DC	3.51
1/2"	16-004	17-004	4HDP-H4DC	3.80
3/4"	16-006	17-004	6HDP-H6DC	8.52
1"	16-008	17-008	8HDP-H8DC ¹	9.79

¹ 8HDP-H8DC fits both 1" and 1 1/4" body sizes

H-Series ISO-B Industrial Interchange Dust Plugs



Body Size	Previous Part #	Aluminum body with steel cable	
		Part #	Price/E
1/4"	16-002A	2HDP-A	\$12.80
3/8"	16-003A	3HDP-A	14.07
1/2"	16-004A	4HDP-A	16.33
3/4"	16-006A	6HDP-A	22.57
1"	16-008A	8HDP-A	52.18
1 1/2"	---	12HDP-A	52.18
2 1/2"	---	20HDP-A	232.52

H-Series ISO-B Industrial Interchange Dust Caps



Body Size	Previous Part #	Aluminum body with steel cable	
		Part #	Price/E
1/4"	17-002A	H2DC-A	\$12.80
3/8"	17-003A	H3DC-A	14.07
1/2"	17-004A	H4DC-A	16.33
3/4"	17-006A	H6DC-A	23.35
1"	17-008A	H8DC-A	56.30
1 1/2"	---	H12DC-A	58.16
2 1/2"	---	H20DC-A	239.57

H-Series Plug Profile Chart

Industry/Competitor Interchange

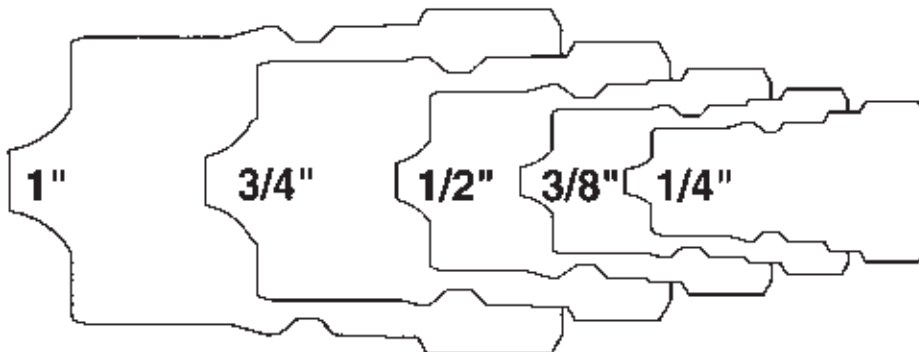

ISO 7241-B
Hansen HK
Aeroquip FD45
Parker 60

H-Series ISO-B Industrial Interchange Coupler Seal Kits

Body Size	Coupler Style	Description	Nitrile	
			Part #	Price/E
1/8"	steel, 303 SS, 316 SS	O-ring and PTFE anti-extrusion ring	1H-SKIT	\$2.21
	brass	two O-rings	1H-BSKIT	2.13
1/4"	steel, 303 SS, 316 SS	O-ring and PTFE anti-extrusion ring	2H-SKIT	4.39
	brass	two O-rings	2H-BSKIT	4.13
3/8"	steel, 303 SS, 316 SS	O-ring and PTFE anti-extrusion ring	3H-SKIT	4.60
	brass	two O-rings	3H-BSKIT	4.33
1/2"	steel, 303 SS, 316 SS	O-ring and PTFE anti-extrusion ring	4H-SKIT	5.42
	brass	two O-rings	4H-BSKIT	5.05
3/4"	steel, 303 SS, 316 SS	O-ring and PTFE anti-extrusion ring	6H-SKIT	7.42
	brass	two O-rings	6H-BSKIT	6.96
1"	steel, 303 SS, 316 SS	O-ring and PTFE anti-extrusion ring	8H-SKIT	9.42
	brass	two O-rings	8H-BSKIT	8.84
1 1/4"	all	adapter / valve O-ring & two body O-rings	10H-SKIT	11.31
1 1/2"	all	adapter / valve O-ring & two body O-rings	12H-SKIT	13.55

Body Size	Coupler Style	Description	FKM	
			Part #	Price/E
1/8"	steel, 303 SS, 316 SS	O-ring and PTFE anti-extrusion ring	F-1H-SKIT	\$4.01
	brass	two O-rings	F-1H-BSKIT	3.77
1/4"	steel, 303 SS, 316 SS	O-ring and PTFE anti-extrusion ring	F-2H-SKIT	6.40
	brass	two O-rings	F-2H-BSKIT	6.02
3/8"	steel, 303 SS, 316 SS	O-ring and PTFE anti-extrusion ring	F-3H-SKIT	6.80
	brass	two O-rings	F-3H-BSKIT	6.40
1/2"	steel, 303 SS, 316 SS	O-ring and PTFE anti-extrusion ring	F-4H-SKIT	7.81
	brass	two O-rings	F-4H-BSKIT	7.33
3/4"	steel, 303 SS, 316 SS	O-ring and PTFE anti-extrusion ring	F-6H-SKIT	10.00
	brass	two O-rings	F-6H-BSKIT	9.40
1"	steel, 303 SS, 316 SS	O-ring and PTFE anti-extrusion ring	F-8H-SKIT	12.22
	brass	two O-rings	F-8H-BSKIT	11.45
1 1/4"	all	adapter / valve O-ring & two body O-rings	F-10H-SKIT	14.63
1 1/2"	all	adapter / valve O-ring & two body O-rings	F-12H-SKIT	17.57

Body Size	Coupler Style	Description	EPDM	
			Part #	Price/E
1/8"	steel, 303 SS, 316 SS	O-ring and PTFE anti-extrusion ring	P-1H-SKIT	\$3.02
	brass	two O-rings	P-1H-BSKIT	2.81
1/4"	steel, 303 SS, 316 SS	O-ring and PTFE anti-extrusion ring	P-2H-SKIT	5.99
	brass	two O-rings	P-2H-BSKIT	5.64
3/8"	steel, 303 SS, 316 SS	O-ring and PTFE anti-extrusion ring	P-3H-SKIT	6.40
	brass	two O-rings	P-3H-BSKIT	6.02
1/2"	steel, 303 SS, 316 SS	O-ring and PTFE anti-extrusion ring	P-4H-SKIT	7.42
	brass	two O-rings	P-4H-BSKIT	6.96
3/4"	steel, 303 SS, 316 SS	O-ring and PTFE anti-extrusion ring	P-6H-SKIT	9.61
	brass	two O-rings	P-6H-BSKIT	9.02
1"	steel, 303 SS, 316 SS	O-ring and PTFE anti-extrusion ring	P-8H-SKIT	11.78
	brass	two O-rings	P-8H-BSKIT	11.08
1 1/4"	all	adapter / valve O-ring & two body O-rings	P-10H-SKIT	14.18
1 1/2"	all	adapter / valve O-ring & two body O-rings	P-12H-SKIT	16.85

H-Series ISO-B Industrial Interchange Repair Kits

Hydraulic Fittings

Body Size	Coupler Style	Seal Material	Description	Nitrile	
				Part #	Price/E
1/4"	steel	nitrile	steel valve assembly and retaining ring	2H-RKIT	\$5.91
	brass	nitrile	brass valve assembly and retaining ring	2H-BRKIT	7.00
	303 stainless	nitrile	303 SS valve assembly and retaining ring	2H-SRKIT	10.34
	316 stainless	nitrile	316 SS valve assembly and retaining ring	2H-SSRKIT	14.85
3/8"	steel	nitrile	steel valve assembly and retaining ring	3H-RKIT	7.85
	brass	nitrile	brass valve assembly and retaining ring	3H-BRKIT	9.14
	303 stainless	nitrile	303 SS valve assembly and retaining ring	3H-SRKIT	14.02
	316 stainless	nitrile	316 SS valve assembly and retaining ring	3H-SSRKIT	18.50
1/2"	steel	nitrile	steel valve assembly and retaining ring	4H-RKIT	10.73
	brass	nitrile	brass valve assembly and retaining ring	4H-BRKIT	15.67
	303 stainless	nitrile	303 SS valve assembly and retaining ring	4H-SRKIT	19.03
	316 stainless	nitrile	316 SS valve assembly and retaining ring	4H-SSRKIT	32.10
3/4"	steel	nitrile	steel valve assembly and retaining ring	6H-RKIT	12.13
	brass	nitrile	brass valve assembly and retaining ring	6H-BRKIT	17.32
	303 stainless	nitrile	303 SS valve assembly and retaining ring	6H-SRKIT	18.94
	316 stainless	nitrile	316 SS valve assembly and retaining ring	6H-SSRKIT	81.12
1"	steel	nitrile	steel valve assembly and retaining ring	8H-RKIT	17.05
	brass	nitrile	brass valve assembly and retaining ring	8H-BRKIT	30.58
	303 stainless	nitrile	303 SS valve assembly and retaining ring	8H-SRKIT	49.37
	316 stainless	nitrile	316 SS valve assembly and retaining ring	8H-SSRKIT	87.60
1 1/4"	steel	nitrile	steel valve assembly and adapter O-ring	10H-RKIT	20.89
	brass	nitrile	brass valve assembly and adapter O-ring	10H-BRKIT	37.12
	303 stainless	nitrile	303 SS valve assembly and adapter O-ring	10H-SRKIT	59.28
	316 stainless	nitrile	316 SS valve assembly and adapter O-ring	10H-SSRKIT	109.49
1 1/2"	steel	nitrile	steel valve assembly and adapter O-ring	12H-RKIT	26.59
	brass	nitrile	brass valve assembly and adapter O-ring	12H-BRKIT	45.88
	303 stainless	nitrile	303 SS valve assembly and adapter O-ring	12H-SRKIT	68.14
	316 stainless	nitrile	316 SS valve assembly and adapter O-ring	12H-SSRKIT	131.40



HT-Series Hydraulic Couplings

Features:

- minimizes fluid loss resulting in a cleaner, safer work environment
- Automatic, push-to-connect couplings provide high flow with low pressure drop assuring maximum hydraulic tool performance.
- To reduce the possibility of accidental disconnect, the sleeve lock safety feature requires turning the collar to unlock the coupling.
- Contact Dixon® for pressure ratings and other technical information.
- conforms to ISO16028 interchange standard interchangeable with Aeroquip FD89, Parker FEM, Snap-tite 74, Faster FFH/2FFN/2FFI, Stucchi A/FIRG and Holmby Series A

HT-Series Flushface Female Threaded Couplers

Body Size	Threads	Steel		316 Stainless Steel	
		Part #	Price/E	Part #	Price/E
1/4"	1/4" - 18 NPTF	2HTF2	\$77.10	---	---
	1/4" - 19 BSPP	2HTBF2	77.10	---	---
	9/16" - 18 ORB	2HTOF3	80.95	---	---
3/8"	3/8" - 18 NPTF	3HTF3	76.45	3HTF3-SS	\$318.81
	3/8" - 19 BSPP	3HTBF3	76.45	3HTBF3-SS	318.81
	9/16" - 18 ORB	3HTOF3	76.45	---	---
	1/2" - 14 NPTF	3HTF4	76.45	3HTF4-SS	318.81
	1/2" - 14 BSPP	3HTBF4	76.45	3HTBF4-SS	318.81
	3/4" - 16 ORB	3HTOF4	76.45	---	---
1/2"	1/2" - 14 NPTF	4HTF4	92.66	4HTF4-SS	360.92
	1/2" - 14 BSPP	4HTBF4	92.66	4HTBF4-SS	360.92
	3/4" - 16 ORB	4HTOF4	98.46	---	---
	7/8" - 14 ORB	4HTOF5	98.46	---	---
	3/4" - 14 NPTF	4HTF6	98.46	4HTF6-SS	384.98
	3/4" - 14 BSPP	4HTBF6	98.46	4HTBF6-SS	384.98
	1-1/16" - 12 ORB	4HTOF6	98.46	---	---
	---	---	---	---	---
5/8"	7/8" - 14 ORB	5HTOF5	139.00	---	---
	3/4" - 14 NPTF	5HTF6	133.20	5HTF6-SS	505.28
	3/4" - 14 BSPP	5HTBF6	133.20	5HTBF6-SS	505.28
	1-1/16" - 12 ORB	5HTOF6	139.00	---	---
3/4"	7/8" - 14 ORB	6HTOF5	202.42	---	---
	3/4" - 14 NPTF	6HTF6	208.49	6HTF6-SS	661.68
	3/4" - 14 BSPP	6HTBF6	208.49	6HTBF6-SS	661.68
	1-1/16" - 12 ORB	6HTOF6	208.49	---	---
	1" - 11 1/2 NPTF	6HTF8	208.49	6HTF8-SS	661.68
	1" - 11 BSPP	6HTBF8	208.49	6HTBF8-SS	661.68
	1-5/16" - 12 ORB	6HTOF8	208.49	---	---
	---	---	---	---	---
1"	1" - 11 1/2 NPTF	8HTF8	289.57	8HTF8-SS	1142.90
	1" - 11 BSPP	8HTBF8	289.57	8HTBF8-SS	1142.90
	1-5/16" - 12 ORB	8HTOF8	289.57	---	---
	1 1/4" - 11 1/2 NPTF	8HTF10	301.15	8HTF10-SS	1203.06
	1 1/4" - 11 BSPP	8HTBF10	301.15	8HTBF10-SS	1203.06
	1 5/8" - 12 ORB	8HTOF10	301.15	---	---
1 1/2"	1 1/2" - 11 1/2 NPTF	12HTF12	1098.63	---	---
	1 1/2" - 11 BSPP	12HTBF12	1098.63	---	---
	1 7/8" - 12 ORB	12HTOF12	1153.56	---	---
2"	2" - 11 1/2 NPTF	16HTF16	1318.35	---	---
	2" - 11 BSPP	16HTBF16	1318.35	---	---
	2 1/2" - 12 ORB	16HTOF16	1384.26	---	---



steel



316 stainless



HT-Series Flushface Male Threaded Couplers

Body Size	Threads	Steel	
		Part #	Price/E
3/8"	3/8" - 18 NPTF	3HTM3	\$81.08
	1/2" - 14 NPTF	3HTM4	81.08
	9/16" - 18 ORB	3HTOM3	81.08
	3/4" - 16 ORB	3HTOM4	81.08
1/2"	1/2" - 14 NPTF	4HTM4	98.46



4HTM4



3HTOM4

HT-Series Flushface Female Threaded Plugs

Body Size	Threads	Steel		316 Stainless Steel	
		Part #	Price/E	Part #	Price/E
1/4"	1/4" - 18 NPTF	HT2F2	\$31.32	---	---
	1/4" - 19 BSPP	HT2BF2	31.32	---	---
	9/16" - 18 ORB	HT2OF3	32.88	---	---
3/8"	3/8" - 18 NPTF	HT3F3	32.43	HT3F3-SS	\$126.33
	3/8" - 19 BSPP	HT3BF3	32.43	HT3BF3-SS	126.33
	9/16" - 18 ORB	HT3OF3	32.43	---	---
	1/2" - 14 NPTF	HT3F4	32.43	HT3F4-SS	126.33
	1/2" - 14 BSPP	HT3BF4	32.43	HT3BF4-SS	126.33
	3/4" - 16 ORB	HT3OF4	32.43	---	---
1/2"	1/2" - 14 NPTF	HT4F4	52.12	HT4F4-SS	216.55
	1/2" - 14 BSPP	HT4BF4	52.12	HT4BF4-SS	216.55
	3/4" - 16 ORB	HT4OF4	57.92	---	---
	7/8" - 14 ORB	HT4OF5	57.92	---	---
	3/4" - 14 NPTF	HT4F6	57.92	HT4F6-SS	240.61
	3/4" - 14 BSPP	HT4BF6	57.92	HT4BF6-SS	240.61
	1-1/16" - 12 ORB	HT4OF6	57.92	---	---
5/8"	7/8" - 14 ORB	HT5OF5	74.13	---	---
	3/4" - 14 NPTF	HT5F6	74.13	HT5F6-SS	288.74
	3/4" - 14 BSPP	HT5BF6	74.13	HT5BF6-SS	288.74
	1-1/16" - 12 ORB	HT5OF6	74.13	---	---
3/4"	7/8" - 14 ORB	HT6OF5	92.22	---	---
	3/4" - 14 NPTF	HT6F6	94.98	HT6F6-SS	445.14
	3/4" - 14 BSPP	HT6BF6	94.98	HT6BF6-SS	445.14
	1-1/16" - 12 ORB	HT6OF6	94.98	---	---
	1" - 11 1/2 NPTF	HT6F8	94.98	HT6F8-SS	445.14
	1" - 11 BSPP	HT6BF8	94.98	HT6BF8-SS	445.14
	1-5/16" - 12 ORB	HT6OF8	94.98	---	---
1"	1" - 11 1/2 NPTF	HT8F8	179.54	HT8F8-SS	643.64
	1" - 11 BSPP	HT8BF8	179.54	HT8BF8-SS	643.64
	1-5/16" - 12 ORB	HT8OF8	179.54	---	---
	1 1/4" - 11 1/2 NPTF	HT8F10	179.54	HT8F10-SS	643.64
	1 1/4" - 11 BSPP	HT8BF10	179.54	HT8BF10-SS	643.64
	1 5/8" - 12 ORB	HT8OF10	179.54	---	---
1 1/2"	1 1/2" - 11 1/2 NPTF	HT12F12	590.39	---	---
	1 1/2" - 11 BSPP	HT12BF12	590.39	---	---
	1 7/8" - 12 ORB	HT12OF12	619.91	---	---
2"	2" - 11 1/2 NPTF	HT16F16	708.46	---	---
	2" - 11 BSPP	HT16BF16	708.46	---	---
	2 1/2" - 12 ORB	HT16OF16	743.89	---	---



steel



316 stainless



HT-Series Flushface Male Threaded Plugs



HT4M4



HT30M4

Body Size	Threads	Steel	
		Part #	Price/E
3/8"	3/8" - 18 NPTF	HT3M3	\$37.07
	1/2" - 14 NPTF	HT3M4	37.07
	9/16" - 18 ORB	HT30M3	37.07
	3/4" - 16 ORB	HT30M4	37.07
1/2"	1/2" - 14 NPTF	HT4M4	63.71

HT-Series Flushface Male Threaded Bulkhead Couplers

Body Size	Threads	Steel	
		Part #	Price/E
1/2"	7/8" - 14 JIC BH	4HTJB5	\$101.93
	1" - 14 ORFS BH	4HTRB5	101.93
	1-1/16" - 12 JIC BH	4HTJB6	101.93



4HTJB5



4HTRB5

HT-Series Flushface Male Threaded Bulkhead Plugs

Body Size	Threads	Steel	
		Part #	Price/E
1/2"	7/8" - 14 JIC BH	HT4JB5	\$63.71
	1" - 14 ORFS BH	HT4RB5	63.71
	1-1/16" - 12 JIC BH	HT4JB6	69.49



HT4JB5



HT4RB5

HT-Series Flushface Dust Plugs

Body Size	Nitrile	
	Part #	Price/E
1/4"	2HTDP	\$7.70
3/8"	3HTDP	8.58
1/2"	4HTDP	11.36
5/8"	5HTDP	13.37
3/4"	6HTDP	14.37
1"	8HTDP	16.49



HT-Series Flushface Dust Caps

Body Size	Nitrile	
	Part #	Price/E
1/4"	HT2DC	\$7.70
3/8"	HT3DC	8.58
1/2"	HT4DC	11.36
5/8"	HT5DC	13.37
3/4"	HT6DC	14.37
1"	HT8DC	16.49



HT-Series Plug Profile Chart

Industry/Competitor Interchange

Parker FEM
Stucchi A/FIRG
Faster FFH

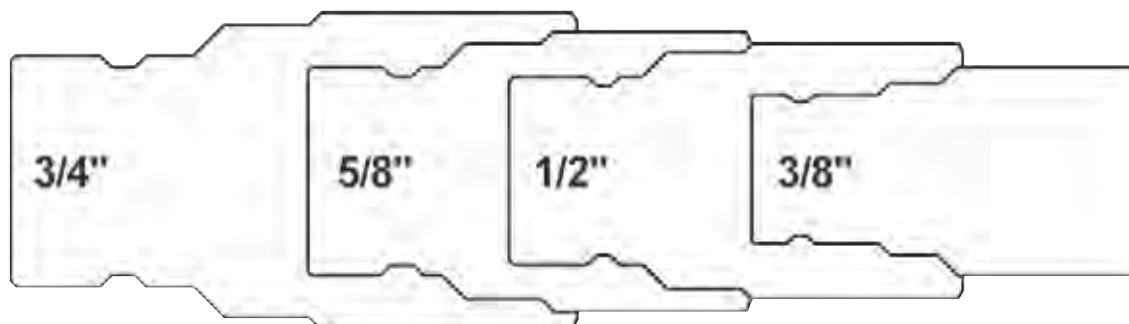

HT-Series Flushface Interchange Coupler Bulkhead Kits

Hydraulic Fittings

Body Size	Mounting Hole	Description	Steel	
			Part #	Price/E
1/4"	1.125"	Two 360° retaining rings	2HT-BMK	\$4.32
3/8"	1.250"	Two 360° retaining rings	3HT-BMK	4.73
1/2"	1.560"	Two 360° retaining rings	4HT-BMK	5.17
5/8"	1.685"	Two 360° retaining rings	5HT-BMK	5.23
3/4"	1.870"	Two 360° retaining rings	6HT-BMK	5.84
1"	2.310"	Two 360° retaining rings	8HT-BMK	7.20

HT-Series Flushface Interchange Coupler Seal Kits

Body Size	Coupler Style	Description	Nitrile	
			Part #	Price/E
1/4"	all	Stem/adapter/gland O-ring, gland B.U.	2HT-SKIT	\$4.88
3/8"	all	Stem/adapter/gland O-ring, gland B.U.	3HT-SKIT	5.47
1/2"	all	Stem/adapter/gland O-ring, gland B.U.	4HT-SKIT	5.95
5/8"	all	Stem/adapter/gland O-ring, gland B.U.	5HT-SKIT	6.37
3/4"	all	Stem/adapter/gland O-ring, gland B.U.	6HT-SKIT	6.52
1"	all	Stem/adapter/gland O-ring, gland B.U.	8HT-SKIT	7.68

HT-Series Flushface Interchange Nipple Seal Kits

Body Size	Nipple Style	Description	Nitrile	
			Part #	Price/E
1/4"	all	Main valve seal and adapter O-ring	HT2-SKIT-V2	\$5.69
3/8"	all	Main valve seal and adapter O-ring	HT3-SKIT-V2	6.80
1/2"	all	Main valve seal and adapter O-ring	HT4-SKIT-V2	7.07
5/8"	all	Main valve seal and adapter O-ring	HT5-SKIT-V2	7.52
3/4"	all	Main valve seal and adapter O-ring	HT6-SKIT-V2	9.17
1"	all	Main valve seal and adapter O-ring	HT8-SKIT-V2	9.73

HTE-Series Hydraulic Couplings

Features:

- non-linear connection force at all pressures
- no maximum connection-pressure restrictions
- head pressure or valve bleed-by has minimal effect on connection force
- less susceptible to system contamination
- design is scalable performing similarly in all sizes
- smooth connection action
- pressure rating **5000 PSI at 70°F (21°C)**

HTE-Series Connect Under Pressure Flushface Female Threaded Plug**Feature:**

- for use with HT series couplers

Body Size	Threads	Steel	
		Part #	Price/E
3/8"	1/2"-14 NPTF	HTE3F4	\$71.50
	1/2"-14 BSPP	HTE3BF4	75.65
	3/4"-16 ORB	HTE3OF4	73.08
1/2"	1/2"-14 NPTF	HTE4F4	84.81
	1/2"-14 BSPP	HTE4BF4	88.97
	3/4"-16 ORB	HTE4OF4	88.08
	7/8"-14 ORB	HTE4OF5	88.08
	3/4"-14 NPTF	HTE4F6	86.39
	3/4"-14 BSPP	HTE4BF6	89.33
	1-1/16"-12 ORB	HTE4OF6	88.08
5/8"	7/8"-14 ORB	HTE5OF5	146.47
	3/4"-14 NPTF	HTE5F6	145.00
	3/4"-14 BSPP	HTE5BF6	150.68
	1-1/16"-12 ORB	HTE5OF6	146.47
3/4"	3/4"-14 NPTF	HTE6F6	171.63
	3/4"-14 BSPP	HTE6BF6	171.63
	1-1/16"-12 ORB	HTE6OF6	173.09
	1"-11 1/2 NPTF	HTE6F8	171.63
	1"-11 BSPP	HTE6BF8	182.97
	1-5/16"-12 ORB	HTE6OF8	173.09
1"	1"-11 1/2 NPTF	HTE8F8	370.17
	1"-11 BSPP	HTE8BF8	370.17
	1-5/16"-12 ORB	HTE8OF8	370.17
	1 1/4"-11 1/2 NPTF	HTE8F10	370.17
	1 1/4"-11 BSPP	HTE8BF10	370.17
	1 5/8"-12 ORB	HTE8OF10	370.17



HS-Series Hydraulic Couplings

Applications:

- designed exclusively for steam applications

Features:

- coupler has a large plated steel sleeve designed for easier gripping with gloves
- special high-temp EPDM O-rings designed for steam service
- rated to **200 PSI** gauge saturated steam **388°F (198°C)**



Warning: Do Not Disconnect Under Pressure!

HS-Series ISO-B Steam Interchange Female Threaded Couplers

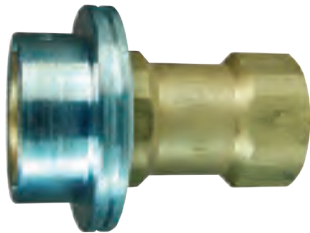

brass



303 stainless

Body Size	Threads	Previous Part #	Brass		303 Stainless Steel	
			Part #	Price/E	Part #	Price/E
1/4"	1/4" - 18 NPTF	B16-200S	2HSF2-B	\$44.92	2HSF2-S	\$91.85
	1/4" - 19 BSPP	---	2HSBF2-B	44.92	2HSBF2-S	91.85
3/8"	3/8" - 18 NPTF	B16-300S	3HSF3-B	48.39	3HSF3-S	113.39
	3/8" - 19 BSPP	---	3HSBF3-B	48.39	3HSBF3-S	113.39
1/2"	1/2" - 14 NPTF	B16-400S	4HSF4-B	67.52	4HSF4-S	171.42
	1/2" - 14 BSPP	---	4HSBF4-B	67.52	4HSBF4-S	171.42
3/4"	3/4" - 14 NPTF	B16-600S	6HSF6-B	105.71	6HSF6-S	271.58
	3/4" - 14 BSPP	---	6HSBF6-B	105.71	6HSBF6-S	271.58
1"	1" - 11 1/2 NPTF	B16-800S	8HSF8-B	171.63	8HSF8-S	464.48
	1" - 11 BSPP	---	8HSBF8-B	171.63	8HSBF8-S	464.48
1 1/2"	1 1/2" - NPTF	B16-1200S	PS-12HF12-B	458.94	---	---

HS-Series ISO-B Steam Interchange Female Threaded Plugs



steel



brass



303 stainless

Body Size	Threads	Steel		Previous Part #	Brass		303 Stainless Steel	
		Part #	Price/E		Part #	Price/E	Part #	Price/E
1/4"	1/4" - 18 NPTF	HS2F2	\$14.28	B17-200S	HS2F2-B	\$13.87	HS2F2-S	\$30.91
	1/4" - 19 BSPP	HS2BF2	14.28	---	HS2BF2-B	13.87	HS2BF2-S	30.91
3/8"	3/8" - 18 NPTF	HS3F3	19.17	B17-300S	HS3F3-B	19.63	HS3F3-S	49.70
	3/8" - 19 BSPP	HS3BF3	19.17	---	HS3BF3-B	19.63	HS3BF3-S	49.70
1/2"	1/2" - 14 NPTF	HS4F4	26.67	B17-400S	HS4F4-B	24.67	HS4F4-S	78.44
	1/2" - 14 BSPP	HS4BF4	26.67	---	HS4BF4-B	24.67	HS4BF4-S	78.44
3/4"	3/4" - 14 NPTF	HS6F6	41.86	B17-600S	HS6F6-B	43.32	HS6F6-S	123.83
	3/4" - 14 BSPP	HS6BF6	41.86	---	HS6BF6-B	43.32	HS6BF6-S	123.83
1"	1" - 11 1/2 NPTF	HS8F8	55.22	B17-800S	HS8F8-B	56.64	HS8F8-S	196.12
	1" - 11 BSPP	HS8BF8	55.22	---	HS8BF8-B	56.64	HS8BF8-S	196.12
1 1/2"	1 1/2" - NPTF	---	---	B17-1200S	PS-H12F12-B	355.40	---	---

V-Series Hydraulic Couplings

Features:

- general purpose hydraulic quick-connect provides superior flow characteristics with built-in reliability
- V Series interchangeable with Snap-tite H Series, see Hydraulic Profile Chart on page H-21
- Buna-N seal standard, contact Dixon® for additional seal material options.
- Contact Dixon® for pressure ratings and other technical information.

V-Series Snap-Tite H/H Interchange Valved Female Threaded Couplers

Body Size	Threads	Previous Part #	Steel		Previous Part #	Brass	
			Part #	Price/E		Part #	Price/E
1/4"	1/8" - 27 NPTF	---	2VF1	\$25.60	---	---	---
	1/4" - 18 NPTF	VHC200	2VF2	24.39	VHC200B	2VF2-B	\$30.55
	1/4" - 19 BSPP	---	2VBF2	24.39	---	2VBF2-B	30.55
	7/16" - 20 ORB	---	2VOF2	25.41	---	---	---
3/8"	3/8" - 18 NPTF	VHC300	3VF3	33.27	VHC300B	3VF3-B	39.72
	3/8" - 19 BSPP	---	3VBF3	33.27	---	3VBF3-B	39.73
	9/16" - 18 ORB	---	3VOF3	35.97	---	---	---
	1/2" - 14 NPTF	---	3VF4	42.75	---	---	---
1/2"	1/2" - 14 NPTF	VHC400	4VF4	40.44	VHC400B	4VF4-B	58.18
	1/2" - 14 BSPP	---	4VBF4	40.44	---	4VBF4-B	58.20
	3/4" - 16 ORB	---	4VOF4	43.51	---	---	---
	3/4" - 14 NPTF	---	4VF6	48.41	---	---	---
3/4"	3/4" - 14 NPTF	VHC600	6VF6	62.58	VHC600B	6VF6-B	90.33
	3/4" - 14 BSPP	---	6VBF6	62.58	---	6VBF6-B	90.33
	1-1/16" - 12 ORB	---	6VOF6	73.01	---	---	---
1"	1" - 11 1/2 NPTF	VHC800	8VF8	97.23	---	8VF8-B	140.99
	1" - 11 BSPP	---	8VBF8	97.12	---	8VBF8-B	140.99
	1-5/16" - 12 ORB	---	8VOF8	115.12	---	---	---
1 1/4"	1 1/4" - 11 1/2 NPTF	VHC1000	10VF10	230.41	---	10VF10-B	289.79
	1 1/4" - 11 BSPP	---	10VBF10	230.41	---	10VBF10-B	289.79
	1 5/8" - 12 ORB	---	10VOF10	267.81	---	---	---
1 1/2"	1 1/2" - 11 1/2 NPTF	VHC1200	12VF12	318.61	---	12VF12-B	402.31
	1 1/2" - 11 BSPP	---	12VBF12	318.61	---	12VBF12-B	402.31
	1 7/8" - 12 ORB	---	12VOF12	377.35	---	---	---
2"	2" - 11 1/2 NPTF	VHC1600	16VF16	605.88	---	16VF16-B	852.55
	2" - 11 BSPP	---	16VBF16	663.75	---	16VBF16-B	852.55



steel

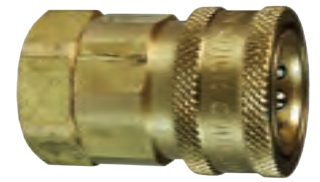

brass

Body Size	Threads	Previous Part #	316 Stainless Steel	
			Part #	Price/E
1/4"	1/4" - 18 NPTF	VHC200SS	2VF2-SS	\$104.32
	1/4" - 19 BSPP	---	2VBF2-SS	104.32
3/8"	3/8" - 18 NPTF	---	3VF3-SS	149.79
	3/8" - 19 BSPP	---	3VBF3-SS	149.79
1/2"	1/2" - 14 NPTF	VHC400SS	4VF4-SS	206.42
	1/2" - 14 BSPP	---	4VBF4-SS	206.42
3/4"	3/4" - 14 NPTF	VHC600SS	6VF6-SS	295.52
	3/4" - 14 BSPP	---	6VBF6-SS	295.52
1"	1" - 11 1/2 NPTF	---	8VF8-SS	455.47
	1" - 11 BSPP	---	8VBF8-SS	455.47
1 1/4"	1 1/4" - 11 1/2 NPTF	---	10VF10-SS	752.83
	1 1/4" - 11 BSPP	---	10VBF10-SS	796.86
1 1/2"	1 1/2" - 11 1/2 NPTF	---	12VF12-SS	1022.29
	1 1/2" - 11 BSPP	---	12VBF12-SS	1082.13
2"	2" - 11 1/2 NPTF	---	16VF16-SS	1832.84
	2" - 11 BSPP	---	16VBF16-SS	1940.06



V-Series Snap-Tite H/IH Interchange Valved Male Threaded Couplers

Hydraulic Fittings



steel



brass



316 stainless



steel - JIC

Body Size	Threads	Steel		Brass		316 Stainless Steel	
		Part #	Price/E	Part #	Price/E	Part #	Price/E
1/4"	1/8" - 27 NPTF	2VM1	\$27.66	---	---	---	---
	1/4" - 18 NPTF	2VM2	25.75	2VM2-B	\$31.32	2VM2-SS	\$118.42
	7/16" - 20 JIC	2VJM2	26.79	---	---	---	---
3/8"	3/8" - 18 NPTF	3VM3	37.36	3VM3-B	40.61	3VM3-SS	161.46
	9/16" - 18 JIC	3VJM3	41.10	---	---	---	---
1/2"	1/2" - 14 NPTF	4VM4	42.49	4VM4-B	59.30	4VM4-SS	240.57
	3/4" - 16 JIC	4VJM4	50.14	---	---	---	---
3/4"	3/4" - 14 NPTF	6VM6	64.99	6VM6-B	90.33	6VM6-SS	371.04
	1-1/16" - 12 JIC	6VJM6	72.14	---	---	---	---
1"	1" - 11 1/2 NPTF	8VM8	109.31	8VM8-B	172.95	8VM8-SS	491.14
	1-5/16" - 12 JIC	8VJM8	120.90	---	---	---	---
1 1/4"	1 1/4" - 11 1/2 NPTF	10VM10	257.93	10VM10-B	361.02	10VM10-SS	837.56
	1 5/8" - 12 JIC	10VJM10	281.24	---	---	---	---
1 1/2"	1 1/2" - 11 1/2 NPTF	12VM12	364.68	12VM12-B	509.11	12VM12-SS	1244.45
2"	2" - 11 1/2 NPTF	16VM16	675.32	16VM16-B	898.96	16VM16-SS	1940.06

V-Series Snap-Tite H/IH Interchange Valved Male Threaded Plugs



steel



brass



316 stainless



steel

Body Size	Threads	Steel		Brass		316 Stainless Steel	
		Part #	Price/E	Part #	Price/E	Part #	Price/E
1/4"	1/8" - 27 NPTF	V2M1	\$20.10	---	---	---	---
	1/4" - 18 NPTF	V2M2	18.08	V2M2-B	\$22.97	V2M2-SS	\$86.84
	7/16" - 20 JIC	V2JM2	\$22.53	---	---	---	---
3/8"	3/8" - 18 NPTF	V3M3	22.53	V3M3-B	31.88	V3M3-SS	118.59
	9/16" - 18 JIC	V3JM3	28.99	---	---	---	---
1/2"	1/2" - 14 NPTF	V4M4	26.96	V4M4-B	42.45	V4M4-SS	181.16
	3/4" - 16 JIC	V4JM4	34.63	---	---	---	---
3/4"	3/4" - 14 NPTF	V6M6	39.74	V6M6-B	58.94	V6M6-SS	278.02
	1-1/16" - 12 JIC	V6JM6	46.92	---	---	---	---
1"	1" - 11 1/2 NPTF	V8M8	71.82	V8M8-B	114.65	V8M8-SS	366.04
	1-5/16" - 12 JIC	V8JM8	89.03	---	---	---	---
1 1/4"	1 1/4" - 11 1/2 NPTF	V10M10	214.58	V10M10-B	276.11	V10M10-SS	671.14
	1 5/8" - 12 JIC	V10JM10	266.24	---	---	---	---
1 1/2"	1 1/2" - 11 1/2 NPTF	V12M12	275.83	V12M12-B	378.43	V12M12-SS	935.09
2"	2" - 11 1/2 NPTF	V16M16	507.46	V16M16-B	745.66	V16M16-SS	889.29

V-Series Snap-Tite H/IH Interchange Valved Female Threaded Plugs

Hydraulic Fittings

Body Size	Threads	Previous Part #	Steel		Previous Part #	Brass	
			Part #	Price/E		Part #	Price/E
1/4"	1/8" - 27 NPTF	---	V2F1	\$18.08	---	---	---
	1/4" - 18 NPTF	VHN200	V2F2	16.72	VHN200B	V2F2-B	\$21.77
	1/4" - 19 BSPP	---	V2BF2	16.72	---	V2BF2-B	21.77
	7/16" - 20 ORB	---	V2OF2	18.78	---	---	---
3/8"	3/8" - 18 NPTF	VHN300	V3F3	20.85	VHN300B	V3F3-B	30.55
	3/8" - 19 BSPP	---	V3BF3	20.84	---	V3BF3-B	30.55
	9/16" - 18 ORB	---	V3OF3	23.53	---	---	---
	1/2" - 14 NPTF	---	V3F4	29.57	---	---	---
1/2"	1/2" - 14 NPTF	VHN400	V4F4	24.91	VHN400B	V4F4-B	40.62
	1/2" - 14 BSPP	---	V4BF4	24.92	---	V4BF4-B	40.62
	3/4" - 16 ORB	---	V4OF4	27.97	---	---	---
	3/4" - 14 NPTF	---	V4F6	41.40	---	---	---
3/4"	3/4" - 14 NPTF	VHN600	V6F6	37.36	VHN600B	V6F6-B	52.54
	3/4" - 14 BSPP	---	V6BF6	37.36	---	V6BF6-B	52.54
	1-1/16" - 12 ORB	---	V6OF6	47.75	---	---	---
1"	1" - 11 1/2 NPTF	VHN800	V8F8	59.70	---	V8F8-B	101.47
	1" - 11 BSPP	---	V8BF8	59.70	---	V8BF8-B	101.46
	1-5/16" - 12 ORB	---	V8OF8	70.67	---	---	---
1 1/4"	1 1/4" - 11 1/2 NPTF	VHN1000	V10F10	187.11	---	V10F10-B	204.90
	1 1/4" - 11 BSPP	---	V10BF10	187.11	---	V10BF10-B	195.14
	1 5/8" - 12 ORB	---	V10OF10	209.99	---	---	---
1 1/2"	1 1/2" - 11 1/2 NPTF	VHN1200	V12F12	229.77	---	V12F12-B	271.65
	1 1/2" - 11 BSPP	---	V12BF12	229.77	---	V12BF12-B	271.65
	1 7/8" - 12 ORB	---	V12OF12	268.10	---	---	---
2"	2" - 11 1/2 NPTF	VHN1600	V16F16	438.03	---	V16F16-B	576.59
	2" - 11 BSPP	---	V16BF16	479.90	---	V16BF16-B	576.59



steel



brass

Body Size	Threads	Previous Part #	316 Stainless Steel	
			Part #	Price/E
1/4"	1/4" - 18 NPTF	VHN200SS	V2F2-SS	\$72.77
	1/4" - 19 BSPP	---	V2BF2-SS	72.77
3/8"	3/8" - 18 NPTF	---	V3F3-SS	106.93
	3/8" - 19 BSPP	---	V3BF3-SS	106.93
1/2"	1/2" - 14 NPTF	VHN400SS	V4F4-SS	147.03
	1/2" - 14 BSPP	---	V4BF4-SS	147.03
3/4"	3/4" - 14 NPTF	VHN600SS	V6F6-SS	202.48
	3/4" - 14 BSPP	---	V6BF6-SS	202.48
1"	1" - 11 1/2 NPTF	---	V8F8-SS	330.38
	1" - 11 BSPP	---	V8BF8-SS	330.38
1 1/4"	1 1/4" - 11 1/2 NPTF	---	V10F10-SS	548.66
	1 1/4" - 11 BSPP	---	V10BF10-SS	548.67
1 1/2"	1 1/2" - 11 1/2 NPTF	---	V12F12-SS	765.07
	1 1/2" - 11 BSPP	---	V12BF12-SS	765.07
2"	2" - 11 1/2 NPTF	---	V16F16-SS	1418.38
	2" - 11 BSPP	---	V16BF16-SS	1501.38



V-Series Snap-Tite H/H Interchange Unvalved Female Threaded Couplers

Hydraulic Fittings



steel



brass



Body Size	Threads	Previous Part #	Steel		Brass	
			Part #	Price/E	Part #	Price/E
1/4"	1/4" - 18 NPTF	---	2VF2-E	\$14.83	2VF2-B-E	\$17.10
	1/4" - 19 BSPP	---	2VBF2-E	15.97	2VBF2-B-E	16.28
3/8"	3/8" - 18 NPTF	---	3VF3-E	21.64	3VF3-B-E	28.33
	3/8" - 19 BSPP	---	3VBF3-E	21.64	3VBF3-B-E	28.33
1/2"	1/2" - 14 NPTF	VHC400NV	4VF4-E	27.30	4VF4-B-E	33.81
	1/2" - 14 BSPP	---	4VBF4-E	27.30	4VBF4-B-E	32.21
3/4"	3/4" - 14 NPTF	VHC600NV	6VF6-E	41.83	6VF6-B-E	48.06
	3/4" - 14 BSPP	---	6VBF6-E	41.83	6VBF6-B-E	48.05
1"	1" - 11 1/2 NPTF	---	8VF8-E	53.93	8VF8-B-E	79.05
	1" - 11 BSPP	---	8VBF8-E	53.93	8VBF8-B-E	75.28
1 1/4"	1 1/4" - 11 1/2 NPTF	---	10VF10-E	109.70	10VF10-B-E	140.10
	1 1/4" - 11 BSPP	---	10VBF10-E	109.70	10VBF10-B-E	140.12
1 1/2"	1 1/2" - 11 1/2 NPTF	---	12VF12-E	166.67	12VF12-B-E	308.65
2"	2" - 11 1/2 NPTF	---	16VF16-E	258.25	16VF16-B-E	715.60

Body Size	Threads	316 Stainless Steel	
		Part #	Price/E
1/4"	1/4" - 18 NPTF	2VF2-SS-E	\$66.68
	1/4" - 19 BSPP	2VBF2-SS-E	66.69
3/8"	3/8" - 18 NPTF	3VF3-SS-E	85.35
	3/8" - 19 BSPP	3VBF3-SS-E	85.35
1/2"	1/2" - 14 NPTF	4VF4-SS-E	108.05
	1/2" - 14 BSPP	4VBF4-SS-E	108.05
3/4"	3/4" - 14 NPTF	6VF6-SS-E	172.05
	3/4" - 14 BSPP	6VBF6-SS-E	172.05
1"	1" - 11 1/2 NPTF	8VF8-SS-E	235.57
	1" - 11 BSPP	8VBF8-SS-E	235.57
1 1/4"	1 1/4" - 11 1/2 NPTF	10VF10-SS-E	362.31
	1 1/4" - 11 BSPP	10VBF10-SS-E	383.50
1 1/2"	1 1/2" - 11 1/2 NPTF	12VF12-SS-E	652.20
2"	2" - 11 1/2 NPTF	16VF16-SS-E	790.50

V-Series Snap-Tite H/IH Interchange Unvalved Male Threaded Couplers

Hydraulic Fittings

Body Size	Threads	Steel		Brass		316 Stainless Steel	
		Part #	Price/E	Part #	Price/E	Part #	Price/E
1/4"	1/4" - 18 NPTF	2VM2-E	\$16.76	2VM2-B-E	\$17.10	2VM2-SS-E	\$74.08
3/8"	3/8" - 18 NPTF	3VM3-E	24.46	3VM3-B-E	28.33	3VM3-SS-E	94.89
1/2"	1/2" - 14 NPTF	4VM4-E	30.80	4VM4-B-E	33.81	4VM4-SS-E	120.06
3/4"	3/4" - 14 NPTF	6VM6-E	47.15	6VM6-B-E	48.05	6VM6-SS-E	191.25
1"	1" - 11 1/2 NPTF	8VM8-E	60.82	8VM8-B-E	79.05	8VM8-SS-E	261.81
1 1/4"	1 1/4" - 11 1/2 NPTF	10VM10-E	123.71	---	---	10VM10-SS-E	402.69
1 1/2"	1 1/2" - 11 1/2 NPTF	12VM12-E	187.95	---	---	12VM12-SS-E	793.92
2"	2" - 11 1/2 NPTF	16VM16-E	319.02	---	---	16VM16-SS-E	878.56

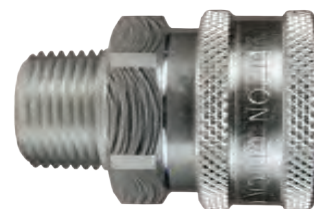

steel



brass



316 stainless

V-Series Snap-Tite H/IH Interchange Unvalved Male Threaded Plugs

Body Size	Threads	Steel		Brass		316 Stainless Steel	
		Part #	Price/E	Part #	Price/E	Part #	Price/E
1/4"	1/4" - 18 NPTF	V2M2-E	\$7.33	V2M2-B-E	\$8.02	V2M2-SS-E	\$23.75
3/8"	3/8" - 18 NPTF	V3M3-E	8.18	V3M3-B-E	9.81	V3M3-SS-E	34.52
1/2"	1/2" - 14 NPTF	V4M4-E	9.72	V4M4-B-E	11.93	V4M4-SS-E	43.07
3/4"	3/4" - 14 NPTF	V6M6-E	14.51	V6M6-B-E	24.04	V6M6-SS-E	90.14
1"	1" - 11 1/2 NPTF	V8M8-E	29.88	V8M8-B-E	36.51	V8M8-SS-E	142.99
1 1/4"	1 1/4" - 11 1/2 NPTF	V10M10-E	64.11	---	---	V10M10-SS-E	227.97
1 1/2"	1 1/2" - 11 1/2 NPTF	V12M12-E	100.06	---	---	V12M12-SS-E	328.62
2"	2" - 11 1/2 NPTF	V16M16-E	160.60	---	---	V16M16-SS-E	454.03



steel

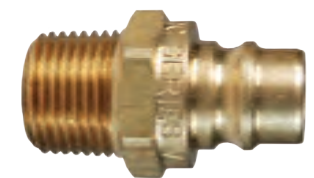

brass



316 stainless

V-Series Snap-Tite H/IH Interchange Unvalved Female Threaded Plugs

Hydraulic Fittings



steel



brass

Body Size	Threads	Previous Part #	Steel		Brass	
			Part #	Price/E	Part #	Price/E
1/4"	1/4" - 18 NPTF	---	V2F2-E	\$7.33	V2F2-B-E	\$8.02
	1/4" - 19 BSPP	---	V2BF2-E	7.33	V2BF2-B-E	8.01
3/8"	3/8" - 18 NPTF	---	V3F3-E	8.18	V3F3-B-E	9.81
	3/8" - 19 BSPP	---	V3BF3-E	8.17	V3BF3-B-E	9.81
1/2"	1/2" - 14 NPTF	VHN400NV	V4F4-E	10.20	V4F4-B-E	11.93
	1/2" - 14 BSPP	---	V4BF4-E	10.20	V4BF4-B-E	11.93
3/4"	3/4" - 14 NPTF	VHN600NV	V6F6-E	14.51	V6F6-B-E	20.84
	3/4" - 14 BSPP	---	V6BF6-E	14.51	V6BF6-B-E	20.84
1"	1" - 11 1/2 NPTF	---	V8F8-E	25.94	V8F8-B-E	27.06
	1" - 11 BSPP	---	V8BF8-E	25.93	V8BF8-B-E	27.06
1 1/4"	1 1/4" - 11 1/2 NPTF	---	V10F10-E	50.63	V10F10-B-E	49.69
	1 1/4" - 11 BSPP	---	V10BF10-E	50.63	V10BF10-B-E	49.68
1 1/2"	1 1/2" - 11 1/2 NPTF	---	V12F12-E	86.49	V12F12-B-E	137.76
	2" - 11 1/2 NPTF	---	V16F16-E	114.28	V16F16-B-E	169.26



Body Size	Threads	316 Stainless Steel	
		Part #	Price/E
1/4"	1/4" - 18 NPTF	V2F2-SS-E	\$23.75
	1/4" - 19 BSPP	V2BF2-SS-E	23.75
3/8"	3/8" - 18 NPTF	V3F3-SS-E	34.52
	3/8" - 19 BSPP	V3BF3-SS-E	34.52
1/2"	1/2" - 14 NPTF	V4F4-SS-E	43.07
	1/2" - 14 BSPP	V4BF4-SS-E	43.07
3/4"	3/4" - 14 NPTF	V6F6-SS-E	60.85
	3/4" - 14 BSPP	V6BF6-SS-E	60.85
1"	1" - 11 1/2 NPTF	V8F8-SS-E	116.37
	1" - 11 BSPP	V8BF8-SS-E	116.37
1 1/4"	1 1/4" - 11 1/2 NPTF	V10F10-SS-E	205.12
	1 1/4" - 11 BSPP	V10BF10-SS-E	205.12
1 1/2"	1 1/2" - 11 1/2 NPTF	V12F12-SS-E	295.66
	2" - 11 1/2 NPTF	V16F16-SS-E	408.51



V-Series Snap-Tite H/IH Interchange Dust Caps / Plugs

Body Size	Previous Part #	Nitrile	
		Part #	Price/E
1/4"	VHC002	1HDP	\$3.16
1/4"	VHN002	V2DC	3.16
3/8"	---	3VDP-V3DC	3.51
1/2"	VHCN003	3KDP-K3DC	3.51
3/4"	VHCN006	6VDP-V6DC	8.52
1"	VHCN008	8VDP-V8DC	10.53



V-Series Snap-Tite H/IH Interchange Dust Plugs

Body Size	Previous Part #	Aluminum body with steel cable	
		Part #	Price/E
1/4"	---	2VDP-A	\$10.12
3/8"	---	3VDP-A	10.88
1/2"	---	4VDP-A	11.56
3/4"	---	6VDP-A	15.60
1"	---	8VDP-A	17.38
1 1/4"	VHC010	10VDP-A	25.81
1 1/2"	VHC012	12VDP-A	52.80
2"	VHC016	16VDP-A	90.07



V-Series Snap-Tite H/IH Interchange Dust Caps

Body Size	Previous Part #	Aluminum body with steel cable	
		Part #	Price/E
1/4"	---	V2DC-A	\$10.12
3/8"	---	V3DC-A	10.71
1/2"	---	V4DC-A	14.77
3/4"	---	V6DC-A	18.55
1"	---	V8DC-A	25.31
1 1/4"	VHN010	V10DC-A	32.05
1 1/2"	VHN012	V12DC-A	61.57
2"	VHN016	V16DC-A	77.44



V-Series Plug Profile Chart

Industry/Competitor Interchange

Snap-tite H
Faster TNV

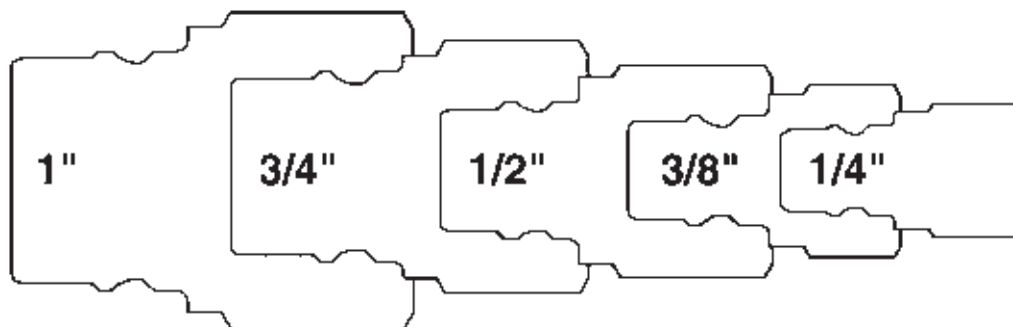

V-Series Snap-Tite H/IH Interchange Coupler Seal Kits

Hydraulic Fittings

Body Size	Coupler Style	Description	Nitrile	
			Part #	Price/E
1/4"	all	body / adapter O-rings and PTFE back-up	2V-SKIT	\$5.05
3/8"	all	body / adapter O-rings and PTFE back-up	3V-SKIT	5.30
1/2"	all	body / adapter O-rings and PTFE back-up	4V-SKIT	6.21
3/4"	all	body / adapter O-rings and PTFE back-up	6V-SKIT	8.52
1"	all	body / adapter O-rings and PTFE back-up	8V-SKIT	10.84
1 1/4"	all	body / adapter/valve O-rings and back-up	10V-SKIT	13.01
1 1/2"	all	body / adapter/valve O-rings and back-up	12V-SKIT	15.59
2"	all	body / adapter/valve O-rings and back-up	16V-SKIT	16.72

Body Size	Coupler Style	Description	FKM	
			Part #	Price/E
1/4"	all	body / adapter O-rings and PTFE back-up	F-2V-SKIT	\$7.36
3/8"	all	body / adapter O-rings and PTFE back-up	F-3V-SKIT	7.83
1/2"	all	body / adapter O-rings and PTFE back-up	F-4V-SKIT	8.99
3/4"	all	body / adapter O-rings and PTFE back-up	F-6V-SKIT	11.51
1"	all	body / adapter O-rings and PTFE back-up	F-8V-SKIT	14.06
1 1/4"	all	body / adapter/valve O-rings and back-up	F-10V-SKIT	16.83
1 1/2"	all	body / adapter/valve O-rings and back-up	F-12V-SKIT	20.20
2"	all	body / adapter/valve O-rings and back-up	F-16V-SKIT	21.27

Body Size	Coupler Style	Description	EPDM	
			Part #	Price/E
1/4"	all	body / adapter O-rings and PTFE back-up	P-2V-SKIT	\$3.47
3/8"	all	body / adapter O-rings and PTFE back-up	P-3V-SKIT	6.88
1/2"	all	body / adapter O-rings and PTFE back-up	P-4V-SKIT	7.36
3/4"	all	body / adapter O-rings and PTFE back-up	P-6V-SKIT	8.52
1"	all	body / adapter O-rings and PTFE back-up	P-8V-SKIT	11.05
1 1/4"	all	body / adapter/valve O-rings and back-up	P-10V-SKIT	13.55
1 1/2"	all	body / adapter/valve O-rings and back-up	P-12V-SKIT	16.58
2"	all	body / adapter/valve O-rings and back-up	P-16V-SKIT	19.37

V-Series Snap-Tite H/H Interchange Coupler Repair Kits

Body Size	Coupler Material	Seal Material	Description	Part #	Price/E
1/4"	steel	nitrile	steel valve assembly and adapter O-ring	2V-RKIT	\$5.91
	brass	nitrile	brass valve assembly and adapter O-ring	2V-BRKIT	7.00
	316 stainless	nitrile	316 SS valve assembly and adapter O-ring	2V-SSRKIT	14.85
3/8"	steel	nitrile	steel valve assembly and adapter O-ring	3V-RKIT	7.85
	brass	nitrile	brass valve assembly and adapter O-ring	3V-BRKIT	8.87
	316 stainless	nitrile	316 SS valve assembly and adapter O-ring	3V-SSRKIT	18.50
1/2"	steel	nitrile	steel valve assembly and adapter O-ring	4V-RKIT	13.32
	brass	nitrile	brass valve assembly and adapter O-ring	4V-BRKIT	17.73
	316 stainless	nitrile	316 SS valve assembly and adapter O-ring	4V-SSRKIT	42.80
3/4"	steel	nitrile	steel valve assembly and adapter O-ring	6V-RKIT	19.94
	brass	nitrile	brass valve assembly and adapter O-ring	6V-BRKIT	31.35
	316 stainless	nitrile	316 SS valve assembly and adapter O-ring	6V-SSRKIT	75.66
1"	steel	nitrile	steel valve assembly and adapter O-ring	8V-RKIT	33.25
	brass	nitrile	brass valve assembly and adapter O-ring	8V-BRKIT	49.76
	316 stainless	nitrile	316 SS valve assembly and adapter O-ring	8V-SSRKIT	120.13
1 1/4"	steel	nitrile	steel valve assembly and adapter O-ring	140030-10	34.71
	316 stainless	nitrile	316 SS valve assembly and adapter O-ring	140032-10	109.32
1 1/2"	steel	nitrile	steel valve assembly and adapter O-ring	140030-12	43.37
	316 stainless	nitrile	316 SS valve assembly and adapter O-ring	140032-12	120.78
2"	steel	nitrile	steel valve assembly and adapter O-ring	140030-16	54.24
	316 stainless	nitrile	316 SS valve assembly and adapter O-ring	140032-16	150.99

V-Series Snap-Tite H/H Interchange Plug Repair Kits

Body Size	Coupler Material	Seal Material	Description	Part #	Price/E
1/4"	steel	nitrile	steel valve assembly and adapter O-ring	V2-RKIT	\$5.91
	brass	nitrile	brass valve assembly and adapter O-ring	V2-BRKIT	7.00
	316 stainless	nitrile	316 SS valve assembly and adapter O-ring	V2-SSRKIT	14.85
3/8"	steel	nitrile	steel valve assembly and adapter O-ring	V3-RKIT	7.85
	brass	nitrile	brass valve assembly and adapter O-ring	V3-BRKIT	9.14
	316 stainless	nitrile	316 SS valve assembly and adapter O-ring	V3-SSRKIT	18.50
1/2"	steel	nitrile	steel valve assembly and adapter O-ring	V4-RKIT	12.77
	brass	nitrile	brass valve assembly and adapter O-ring	V4-BRKIT	17.53
	316 stainless	nitrile	316 SS valve assembly and adapter O-ring	V4-SSRKIT	40.39
3/4"	steel	nitrile	steel valve assembly and adapter O-ring	V6-RKIT	19.70
	brass	nitrile	brass valve assembly and adapter O-ring	V6-BRKIT	30.32
	316 stainless	nitrile	316 SS valve assembly and adapter O-ring	V6-SSRKIT	73.24
1"	steel	nitrile	steel valve assembly and adapter O-ring	V8-RKIT	28.87
	brass	nitrile	brass valve assembly and adapter O-ring	V8-BRKIT	37.13
	316 stainless	nitrile	316 SS valve assembly and adapter O-ring	V8-SSRKIT	89.67
1 1/4"	steel	nitrile	steel valve assembly and adapter O-ring	140030-10	34.71
	316 stainless	nitrile	316 SS valve assembly and adapter O-ring	140032-10	109.32
1 1/2"	steel	nitrile	steel valve assembly and adapter O-ring	140030-12	43.37
	316 stainless	nitrile	316 SS valve assembly and adapter O-ring	140032-12	120.78
2"	steel	nitrile	steel valve assembly and adapter O-ring	140030-16	54.24
	316 stainless	nitrile	316 SS valve assembly and adapter O-ring	140032-16	150.99



K-Series Hydraulic Couplings

Hydraulic Fittings

Features:

- poppet style shut-off valves in both coupler and plug
- to connect, simply retract sleeve, insert plug, and release sleeve
- interchangeable with Aeroquip 5600, Parker 6600, and **ISO A interchange**, see Hydraulic Profile Chart on page H-25
- Contact Dixon® for pressure ratings and other technical information.

K-Series ISO-A 5600 Interchange Female Threaded Couplers



4KF4 - steel



6KF6 - steel



10KF10 - steel

Body Size	Threads	Previous Part #	Steel		316 Stainless Steel	
			Part #	Price/E	Part #	Price/E
1/4"	1/8" - 27 NPTF	56-100	2KF1	\$26.06	---	---
	1/4" - 18 NPTF	56-200	2KF2	21.14	2KF2-SS	\$153.99
	1/4" - 19 BSPP	---	2KBF2	26.06	2KBF2-SS	153.99
	7/16" - 20 ORB	---	2KOF2	26.06	---	---
3/8"	3/8" - 18 NPTF	56-300	3KF3	28.38	3KF3-SS	205.64
	3/8" - 19 BSPP	---	3KBF3	33.01	3KBF3-SS	205.64
	9/16" - 18 ORB	---	3KOF3	33.01	---	---
1/2"	1/2" - 14 NPTF	56-400	4KF4	28.38	4KF4-SS	288.37
	1/2" - 14 BSPP	---	4KBF4	33.01	4KBF4-SS	288.37
	3/4" - 16 ORB	---	4KOF4	33.01	---	---
	7/8" - 14 ORB	---	4KOF5	34.75	---	---
	3/4" - 14 NPTF	56-600	4KF6	46.91	---	---
3/4"	3/4" - 14 NPTF	56-660	6KF6	55.60	6KF6-SS	435.63
	3/4" - 14 BSPP	---	6KBF6	69.49	6KBF6-SS	435.63
	1-1/16" - 12 ORB	---	6KOF6	69.49	---	---
1"	1" - 11 1/2 NPTF	56-800	8KF8	81.08	8KF8-SS	662.65
	1" - 11 BSPP	---	8KBF8	101.93	8KBF8-SS	662.65
	1-5/16" - 12 ORB	---	8KOF8	101.93	---	---
1 1/4"	1 1/4" - 11 1/2 NPT	---	10KF10	214.57	---	---
	1 1/4" - 11 BSPP	---	10KBF10	238.40	---	---
1 1/2"	1 1/2" - 11 1/2 NPT	---	12KF12	357.61	---	---
	1 1/2" - 11 BSPP	---	12KBF12	393.37	---	---
2"	2" - 11 1/2 NPT	---	16KF16	709.26	---	---
	2" - 11 BSPP	---	16KBF16	750.97	---	---

K-Series ISO-A 5600 Interchange Female Threaded Plugs



K4F4 - steel



K6F6 - steel

Body Size	Threads	Previous Part #	Steel		316 Stainless Steel	
			Part #	Price/E	Part #	Price/E
1/4"	1/8" - 27 NPTF	57-100	K2F1	\$14.13	---	---
	1/4" - 18 NPTF	57-200	K2F2	9.56	K2F2-SS	\$70.73
	1/4" - 19 BSPP	---	K2BF2	14.13	K2BF2-SS	70.73
	7/16" - 20 ORB	---	K2OF2	14.13	---	---
3/8"	3/8" - 18 NPTF	57-300	K3F3	12.45	K3F3-SS	104.37
	3/8" - 19 BSPP	---	K3BF3	18.53	K3BF3-SS	104.37
	9/16" - 18 ORB	---	K3OF3	18.53	---	---
1/2"	1/2" - 14 NPTF	57-400	K4F4	13.32	K4F4-SS	134.98
	1/2" - 14 BSPP	---	K4BF4	19.12	K4BF4-SS	134.98
	3/4" - 16 ORB	---	K4OF4	19.12	---	---
	7/8" - 14 ORB	---	K4OF5	20.85	---	---
	3/4" - 14 NPTF	57-600	K4F6	25.48	---	---
3/4"	3/4" - 14 NPTF	57-660	K6F6	28.38	K6F6-SS	300.65
	3/4" - 14 BSPP	---	K6BF6	36.48	K6BF6-SS	300.65
	1-1/16" - 12 ORB	---	K6OF6	36.48	---	---
1"	1" - 11 1/2 NPTF	57-800	K8F8	44.01	K8F8-SS	300.65
	1" - 11 BSPP	---	K8BF8	50.96	K8BF8-SS	300.65
	1-5/16" - 12 ORB	---	K8OF8	50.96	---	---
1 1/4"	1 1/4" - 11 1/2 NPT	---	K10F10	122.78	---	---
	1 1/4" - 11 BSPP	---	K10BF10	143.05	---	---
1 1/2"	1 1/2" - 11 1/2 NPT	---	K12F12	184.76	---	---
	1 1/2" - 11 BSPP	---	K12BF12	220.52	---	---
2"	2" - 11 1/2 NPT	---	K16F16	345.69	---	---
	2" - 11 BSPP	---	K16BF16	387.41	---	---

K-Series ISO-A 5600 Interchange Dust Caps / Plugs

Body Size	Previous Part #	Nitrile	
		Part #	Price/E
1/4"	56-002 / 57-002	2KDP-K2DC	\$3.16
3/8"	56-003 / 57-003 / VHCN004	3KDP-K3DC	3.51
3/4"	56-006 / 57-006	6KDP-K6DC	5.29
1"	56-008 / 57-008	8KDP-K8DC	6.68



K-Series ISO-A 5600 Interchange Dust Plugs



Body Size	Color	Previous Part #	Nitrile	
			Part #	Price/E
1/2"	black	56-004	4KDP	\$3.16
	red	---	4K-R-DP	3.16
	orange	---	4K-O-DP	3.16
	yellow	---	4K-Y-DP	3.16
	green	---	4K-G-DP	3.16
	blue	---	4K-B-DP	3.16

K-Series ISO-A 5600 Interchange Dust Caps



Body Size	Color	Previous Part #	Nitrile	
			Part #	Price/E
1/2"	black	57-004	K4DC	\$3.16
	red	---	K4-R-DC	3.16
	orange	---	K4-O-DC	3.16
	yellow	---	K4-Y-DC	3.16
	green	---	K4-G-DC	3.16
	blue	---	K4-B-DC	3.16

K-Series ISO-A 5600 Interchange Coupler Seal Kits

Body Size	Coupler Style	Description	Nitrile	
			Part #	Price/E
1/4"	all	O-ring and PTFE anti-extrusion ring	2K-SKIT	\$2.21
3/8"	all	O-ring and PTFE anti-extrusion ring	3K-SKIT	4.60
1/2"	all	O-ring and PTFE anti-extrusion ring	4K-SKIT	5.42
3/4"	all	O-ring and PTFE anti-extrusion ring	6K-SKIT	7.42
1"	all	O-ring and PTFE anti-extrusion ring	8K-SKIT	9.42
1 1/4"	all	O-ring and PTFE anti-extrusion ring	10K-SKIT	13.69
1 1/2"	all	O-ring and PTFE anti-extrusion ring	12K-SKIT	14.92
2"	all	O-ring and PTFE anti-extrusion ring	16K-SKIT	16.37

K-Series ISO-A 5600 Plug Profile Chart

Industry/Competitor Interchange

ISO 7241-A
Perfecting K Series
Aeroquip 5600
Parker 6600

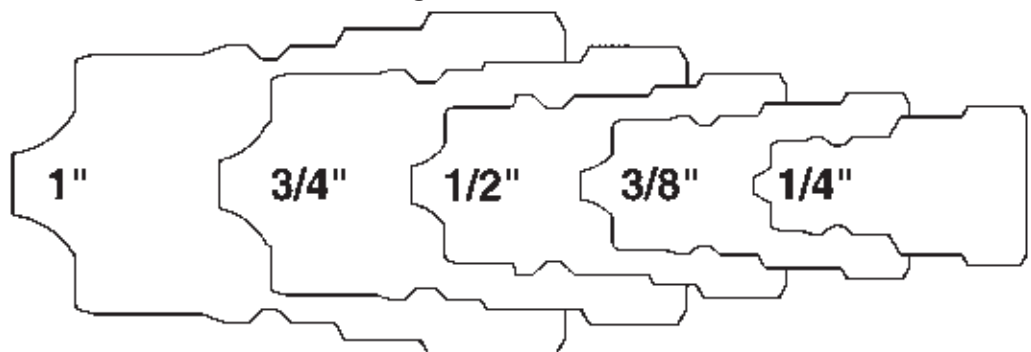

AG-Series Hydraulic Couplings

Application:

- used on construction equipment, farm implements and most other mobile equipment

Features:

- ball style shut-off valves in both the coupler and the plug
- interchangeable with Pioneer 4000 series, see Hydraulic Profile Chart on page H-27
- Contact Dixon® for pressure ratings and other technical information.

AG-Series Agricultural Ball Couplers



Body Size	Female Threads	Previous Part #	Steel	
			Part #	Price/E
1/4"	1/4" - 18 NPTF	---	2AGF2	\$24.43
3/8"	3/8" - 18 NPTF	---	3AGF3	25.63
1/2"	1/2" - 14 NPTF	18-400	4AGF4	29.20
	1/2" - 14 BSPP	---	4AGBF4	33.97
	3/4" - 16 ORB	18-415	4AGOF4	33.97
	7/8" - 14 ORB	---	4AGOF5	35.76
3/4"	3/4" - 14 NPTF	18-600	4AGF6	48.28
	3/4" - 14 NPTF	18-660	6AGF6	65.56
1"	1" - 11 1/2 NPTF	---	8AGF8	88.21

AG-Series Agricultural Poppet Valve Couplers



Body Size	Female Threads	Previous Part #	Steel	
			Part #	Price/E
1/4"	1/4" - 18 NPTF	18-200	2AGF2-PV	\$24.43
3/8"	3/8" - 18 NPTF	18-300	3AGF3-PV	25.63
1/2"	1/2" - 14 NPTF	---	4AGF4-PV	27.55
	1/2" - 14 BSPP	---	4AGBF4-PV	32.05
	3/4" - 16 ORB	---	4AGOF4-PV	32.05
	7/8" - 14 ORB	---	4AGOF5-PV	33.73
3/4"	3/4" - 14 NPTF	---	4AGF6-PV	45.55
	3/4" - 14 NPTF	---	6AGF6-PV	65.56
1"	1" - 11 1/2 NPTF	18-800	8AGF8-PV	88.21

AG-Series Agricultural Push-Pull Ball Couplers



Body Size	Female Threads	Steel	
		Part #	Price/E
3/8"	3/8" - 18 NPTF	NEW 3AGF3-PS	\$37.38
1/2"	1/2" - 14 NPTF	4AGF4-PS	41.73
	3/4" - 16 ORB	4AGOF4-PS	43.15
	7/8" - 14 ORB	4AGOF5-PS	44.64
	3/4" - 14 NPTF	4AGF6-PS	44.65
3/4"	3/4" - 14 NPTF	NEW 6AGF6-PS	95.31

AG-Series Agricultural Push-Pull Poppet Valve Couplers



Body Size	Female Threads	Steel	
		Part #	Price/E
3/8"	3/8" - 18 NPTF	NEW 3AGF3-PV-PS	\$37.38
1/2"	1/2" - 14 NPTF	4AGF4-PV-PS	41.73
	3/4" - 16 ORB	4AGOF4-PV-PS	43.15
	7/8" - 14 ORB	4AGOF5-PV-PS	44.65
	3/4" - 14 NPTF	4AGF6-PV-PS	42.91
3/4"	3/4" - 14 NPTF	NEW 6AGF6-PV-PS	95.31

AG-Series Agricultural Ball Plugs

Body Size	Female Threads	Previous Part #	Steel	
			Part #	Price/E
1/4"	1/4" - 18 NPTF	---	AG2F2	\$9.84
3/8"	3/8" - 18 NPTF	---	AG3F3	11.92
1/2"	1/2" - 14 NPTF	19-400	AG4F4	12.51
	1/2" - 14 BSPP	---	AG4BF4	16.69
	3/4" - 16 ORB	19-415	AG4OF4	16.69
	7/8" - 14 ORB	---	AG4OF5	17.88
	3/4" - 14 NPTF	19-600	AG4F6	19.08
3/4"	3/4" - 14 NPTF	19-660	AG6F6	32.19
1"	1" - 11 1/2 NPTF	---	AG8F8	47.68



AG-Series Agricultural Poppet Valve Plugs

Body Size	Female Threads	Previous Part #	Steel	
			Part #	Price/E
1/4"	1/4" - 18 NPTF	---	AG2F2-PV	\$9.84
3/8"	3/8" - 18 NPTF	---	AG3F3-PV	11.92
1/2"	1/2" - 14 NPTF	19-400	AG4F4-PV	12.51
	1/2" - 14 BSPP	---	AG4BF4-PV	16.69
	3/4" - 16 ORB	19-415	AG4OF4-PV	16.69
	7/8" - 14 ORB	---	AG4OF5-PV	17.88
	3/4" - 14 NPTF	19-600	AG4F6-PV	19.08
3/4"	3/4" - 14 NPTF	19-660	AG6F6-PV	32.19
1"	1" - 11 1/2 NPTF	---	AG8F8-PV	47.68



AG-Series Agricultural Dust Plugs

Body Size	Previous Part #	Elastomer	
		Part #	Price/E
1/4"	18-002	2AGDP	\$4.35
3/8"	18-003	3AGDP	6.26
1/2"	For 1/2" Please refer to the color coded K-Series Dust Plugs on pg. H-25		
3/4"	18-006	6AGDP	9.45
1"	18-008	8AGDP	10.88



AG-Series Agricultural Dust Caps

Body Size	Previous Part #	Elastomer	
		Part #	Price/E
1/4"	19-002	AG2DC	\$4.56
3/8"	19-003	AG3DC	5.25
1/2"	For 1/2" Please refer to the color coded K-Series Dust Caps on pg. H-25		
3/4"	19-006	AG6DC	13.15
1"	19-008	AG8DC	15.07



AG-Series Plug Profile Chart

Industry/Competitor Interchange

Parker/Pioneer 4000
Safeway S20

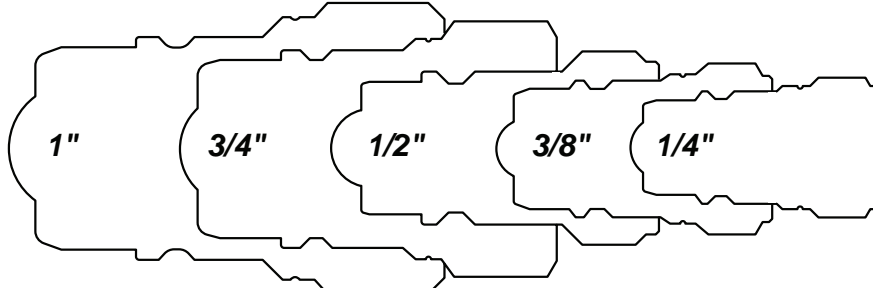

CM-Series Hydraulic Couplings

Features:

- interchangeable with Foster Series- FJT, Hansen Flo-Temp, Tomco MC-Series, Parker Moldmate, DME Jiffy-Tite
- temperature range **-90°F to 400°F (-68°C to 205°C)**
- Contact Dixon® for pressure ratings and other technical information.

CM-Series Industrial Mold Interchange Plug Female NPTF

steel



brass

Body Size	Threads	Steel		Brass	
		Part #	Price/E	Part #	Price/E
1/4"	1/8" - 27 NPTF	CM2F1	\$1.96	CM2F1-B	\$2.08
	1/4" - 18 NPTF	CM2F2	2.07	CM2F2-B	2.22
	3/8" - 18 NPTF	CM2F3	2.59	CM2F3-B	3.05
3/8"	1/4" - 18 NPTF	CM3F2	2.61	CM3F2-B	2.67
	3/8" - 18 NPTF	CM3F3	3.38	CM3F3-B	3.97
1/2"	1/2" - 14 NPTF	---	---	CM4F4-B	7.64
	3/4" - 14 NPTF	---	---	CM4F6-B	10.73

CM-Series Industrial Mold Interchange Plug Male NPTF

Body Size	Threads	Brass	
		Part #	Price/E
1/4"	1/8" - 27 NPTF	CM2M1-B	\$1.57
	1/4" - 18 NPTF	CM2M2-B	1.96
	3/8" - 18 NPTF	CM2M3-B	2.34
3/8"	1/4" - 18 NPTF	CM3M2-B	2.15
	3/8" - 18 NPTF	CM3M3-B	2.34
	1/2" - 14 NPTF	CM3M4-B	3.93
1/2"	1/2" - 14 NPTF	CM4M4-B	4.56
	3/4" - 14 NPTF	CM4M6-B	6.95

CM-Series Industrial Mold Interchange Extension Plug Male NPTF

Body Size	Threads	Brass	
		Part #	Price/E
1/4"	1/8" - 27 NPTF	CM2M1-B-L2.5	\$9.70
	1/8" - 27 NPTF	CM2M1-B-L4	11.46
	1/8" - 27 NPTF	CM2M1-B-L5.5	15.58
	1/4" - 18 NPTF	CM2M2-B-L2.5	10.62
	1/4" - 18 NPTF	CM2M2-B-L4	12.55
	1/4" - 18 NPTF	CM2M2-B-L5.5	16.63
	1/4" - 18 NPTF	CM2M2-B-L7	19.71
3/8"	1/8" - 27 NPTF	CM3M1-B-L2.5	10.62
	1/8" - 27 NPTF	CM3M1-B-L4	12.55
	1/8" - 27 NPTF	CM3M1-B-L5.5	17.66
	1/8" - 27 NPTF	CM3M1-B-L7	19.71
	1/4" - 18 NPTF	CM3M2-B-L2.5	10.62
	1/4" - 18 NPTF	CM3M2-B-L4	12.55
	1/4" - 18 NPTF	CM3M2-B-L5.5	16.63
	1/4" - 18 NPTF	CM3M2-B-L7	19.71
	1/4" - 18 NPTF	CM3M2-B-L8.5	22.23
	1/4" - 18 NPTF	CM3M2-B-L11.5	26.09

CM-Series Industrial Mold Interchange Unvalved Coupler Female NPTF

Body Size	Threads	Brass	
		Part #	Price/E
1/4"	1/8" - 27 NPTF	2CMF1-B-E	\$8.77
	1/4" - 18 NPTF	2CMF2-B-E	9.03
3/8"	1/4" - 18 NPTF	3CMF2-B-E	10.88
	3/8" - 18 NPTF	3CMF3-B-E	11.37
1/2"	1/2" - 14 NPTF	4CMF4-B-E	25.59



CM-Series Industrial Mold Interchange Valved Coupler Female NPTF

Body Size	Threads	Brass	
		Part #	Price/E
1/4"	1/8" - 27 NPTF	2CMF1-B	\$9.89
3/8"	1/4" - 18 NPTF	3CMF2-B	14.38



CM-Series Industrial Mold Interchange Unvalved Coupler Hose Barb

Body Size	Hose ID	Brass	
		Part #	Price/E
1/4"	1/4"	2CMS2-B-E	\$10.11
	5/16"	2CMS2.5-B-E	10.11
	3/8"	2CMS3-B-E	10.11
3/8"	3/8"	3CMS3-B-E	13.02
	1/2"	3CMS4-B-E	13.02
1/2"	1/2"	4CMS4-B-E	29.76
	3/4"	4CMS6-B-E	29.76



CM-Series Industrial Mold Interchange Valved Coupler Hose Barb

Body Size	Hose ID	Brass	
		Part #	Price/E
1/4"	1/4"	2CMS2-B	\$11.59
	5/16"	2CMS2.5-B	11.68
	3/8"	2CMS3-B	17.17
3/8"	3/8"	3CMS3-B	17.50
	1/2"	3CMS4-B	17.50

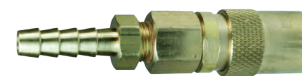

CM-Series Industrial Mold Interchange Unvalved Coupler Push-Loc Barb

Body Size	Hose ID	Brass	
		Part #	Price/E
1/4"	1/4"	2CMB2-B-E	\$11.23
	3/8"	2CMB3-B-E	11.23
3/8"	3/8"	3CMB3-B-E	15.16
	1/2"	3CMB4-B-E	15.16
1/2"	1/2"	4CMB4-B-E	29.76
	3/4"	4CMB6-B-E	29.76

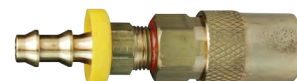

CM-Series Industrial Mold Interchange Valved Coupler Push-Loc Barb



Body Size	Hose ID	Brass	
		Part #	Price/E
1/4"	1/4"	2CMB2-B	\$14.15
	3/8"	2CMB3-B	17.50
3/8"	3/8"	3CMB3-B	18.42
	1/2"	3CMB4-B	18.42

CM-Series Industrial Mold Interchange Unvalved Coupler 45° Hose Barb



Body Size	Hose ID	Brass	
		Part #	Price/E
1/4"	1/4"	2CM4S2-B-E	\$14.81
	5/16"	2CM4S2.5-B-E	14.81
	3/8"	2CM4S3-B-E	14.81
3/8"	3/8"	3CM4S3-B-E	19.76
	1/2"	3CM4S4-B-E	19.76
1/2"	1/2"	4CM4S4-B-E	39.96
	3/4"	4CM4S6-B-E	39.96

CM-Series Industrial Mold Interchange Valved Coupler 45° Hose Barb



Body Size	Hose ID	Brass	
		Part #	Price/E
1/4"	1/4"	2CM4S2-B	\$17.50
	5/16"	2CM4S2.5-B	17.50
	3/8"	2CM4S3-B	17.50
3/8"	3/8"	3CM4S3-B	24.70
	1/2"	3CM4S4-B	24.70

CM-Series Industrial Mold Interchange Unvalved Coupler 45° Push-Loc Barb



Body Size	Hose ID	Brass	
		Part #	Price/E
1/4"	1/4"	2CM4B2-B-E	\$15.81
	3/8"	2CM4B3-B-E	15.81
3/8"	3/8"	3CM4B3-B-E	21.78
	1/2"	3CM4B4-B-E	21.78
1/2"	1/2"	4CM4B4-B-E	41.12
	3/4"	4CM4B6-B-E	43.44

CM-Series Industrial Mold Interchange Valved Coupler 45° Push-Loc Barb



Body Size	Hose ID	Brass	
		Part #	Price/E
1/4"	1/4"	2CM4B2-B	\$18.86
	3/8"	2CM4B3-B	18.86
3/8"	3/8"	3CM4B3-B	28.53
	1/2"	3CM4B4-B	28.53

CM-Series Industrial Mold Interchange Unvalved Coupler 90° Hose Barb

Body Size	Hose ID	Brass	
		Part #	Price/E
1/4"	1/4"	2CM9S2-B-E	\$14.81
	5/16"	2CM9S2.5-B-E	14.81
	3/8"	2CM9S3-B-E	14.81
3/8"	3/8"	3CM9S3-B-E	19.76
	1/2"	3CM9S4-B-E	19.76
1/2"	1/2"	4CM9S4-B-E	46.93
	3/4"	4CM9S6-B-E	47.54



CM-Series Industrial Mold Interchange Valved Coupler 90° Hose Barb

Body Size	Hose ID	Brass	
		Part #	Price/E
1/4"	1/4"	2CM9S2-B	\$19.76
	5/16"	2CM9S2.5-B	19.76
	3/8"	2CM9S3-B	19.76
3/8"	3/8"	3CM9S3-B	24.94
	1/2"	3CM9S4-B	24.94



CM-Series Industrial Mold Interchange Unvalved Coupler 90° Push-Loc Barb

Body Size	Hose ID	Brass	
		Part #	Price/E
1/4"	1/4"	2CM9B2-B-E	\$15.81
	3/8"	2CM9B3-B-E	15.81
3/8"	3/8"	3CM9B3-B-E	21.78
	1/2"	3CM9B4-B-E	21.78
1/2"	1/2"	4CM9B4-B-E	39.96
	3/4"	4CM9B6-B-E	39.96



CM-Series Industrial Mold Interchange Valved Coupler 90° Push-Loc Barb

Body Size	Hose ID	Brass	
		Part #	Price/E
1/4"	1/4"	2CM9B2-B	\$20.44
	3/8"	2CM9B3-B	20.44
3/8"	3/8"	3CM9B3-B	29.63
	1/2"	3CM9B4-B	29.63



CM-Series Industrial Mold Interchange Dust Plugs

Body Size	Lanyard	Brass	
		Part #	Price/E
1/4"	N/A	2CMPC-B	\$4.49
3/8"	N/A	3CMPC-B	4.49
1/2"	N/A	4CMPC-B	9.96



CM-Series Industrial Mold Interchange Coupler Seal Kits

Body Size	Coupler Style	Seal Kit Contents	Silicone	
			Part #	Price/E
1/4"	all	body seal	2CM-SKIT	\$1.76
3/8"	all	body seal	3CM-SKIT	2.01
1/2"	all	body seal	4CM-SKIT	3.38

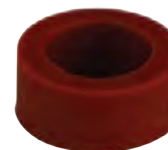

PD-Series Diagnostic Interchange Couplings

Features:

- interchangeable with ISO15171-1, Parker PD-Series, Aeroquip FD90, Tomco Series DK
- steel componentry is plated using ROHS Compliant Trivalent Chrome
- PTFE anti-extrusion ring protects main coupler O-ring from dynamic impulse pressure damage
- pressure rating **6000 PSI at 70°F (21°C)**

PD-Series Diagnostic Interchange Female NPT Couplers



Body Size	Threads	Steel	
		Part #	Price/E
1/8"	1/8" - 27 NPT	1PDF1	\$48.52
	1/4" - 18 NPT	1PDF2	48.52

PD-Series Diagnostic Interchange Male NPT Couplers



Body Size	Threads	Steel	
		Part #	Price/E
1/8"	1/4" - 18 NPT	1PDM2	\$48.52

PD-Series Diagnostic Interchange Female NPT Plugs



Body Size	Threads	Steel	
		Part #	Price/E
1/8"	1/8" - 27 NPT	PD1F1	\$15.83
	1/4" - 18 NPT	PD1F2	11.92

PD-Series Diagnostic Interchange Male Threaded Plugs



Body Size	Threads	Steel	
		Part #	Price/E
1/8"	1/8" - 27 NPT	PD1M1	\$13.11
	1/4" - 18 NPT	PD1M2	11.92
	7/16" - 20 ORB	PD1OM2	12.81
	9/16" - 18 ORB	PD1OM3	12.51

PD-Series Diagnostic Interchange Dust Caps



Body Size	Nitrile	
	Part #	Price/E
1/8"	H1DC	\$3.16

ST-Series Hydraulic Couplings

Features:

- interchangeable with Snap-Tite 71-Series
- nitrile (Buna-N) seals are standard, providing a temperature range of **-40°F to 250°F** (**-40°C to 121°C**) contact Dixon® for additional seal material options.
- Contact Dixon® for pressure ratings and other technical information.
- steel coupler sleeves are hardened to resist deformation and maximize service life
- steel nipples are hardened to provide heavy duty performance

ST-Series Snap-Tite 71 Interchange Female Threaded Couplers

Body Size	Threads	Steel		316 Stainless Steel	
		Part #	Price/E	Part #	Price/E
1/4"	1/4" - 18 NPTF	2STF2	\$86.78	2STF2-SS	\$246.02
	1/4" - 19 BSPP	2STBF2	86.78	2STBF2-SS	246.02
3/8"	1/4" - 18 NPTF	3STF2	82.12	---	---
	3/8" - 18 NPTF	3STF3	82.12	3STF3-SS	293.54
	3/8" - 19 BSPP	3STBF3	82.12	3STBF3-SS	293.54
	1/2" - 14 NPTF	3STF4	82.12	3STF4-SS	293.54
	1/2" - 14 BSPP	3STBF4	82.12	3STBF4-SS	293.54
1/2"	1/2" - 14 NPTF	4STF4	100.45	4STF4-SS	384.51
	1/2" - 14 BSPP	4STBF4	100.45	4STBF4-SS	384.51
	3/4" - 16 ORB	4STOF4	105.03	---	---
3/4"	3/4" - 14 NPTF	6STF6	139.77	6STF6-SS	668.69
	3/4" - 14 BSPP	6STBF6	139.77	6STBF6-SS	668.69
	1-1/16" - 12 ORB	6STOF6	151.92	---	---
1"	1" - 11 1/2 NPTF	8STF8	252.80	8STF8-SS	1052.58
	1" - 11 BSPP	8STBF8	252.80	8STBF8-SS	1052.58
	1-5/16" - 12 ORB	8STOF8	278.40	---	---
	1 1/4" - 11 1/2 NPTF	8STF10	295.34	8STF10-SS	1263.10
	1 1/4" - 11 BSPP	8STBF10	295.34	8STBF10-SS	1263.10
	1 5/8" - 12 ORB	8STOF10	303.67	---	---



steel



316 stainless

ST-Series Snap-Tite 71 Interchange Old Style Female Threaded Couplers

Body Size	Threads	Steel		316 Stainless Steel	
		Part #	Price/E	Part #	Price/E
1"	1" - 11 1/2 NPTF	8STF8-V2	\$274.08	---	---
	1" - 11 BSPP	8STBF8-V2	274.08	---	---
	1 1/4" - 11 1/2 NPTF	8STF10-V2	303.69	---	---
2"	1 1/2" - 11 1/2 NPTF	16STF12	1397.71	---	---
	1 1/2" - 11 BSPP	16STBF12	1397.71	---	---
	1-7/8" - 12 ORB	16STOF12	1458.47	---	---
	2" - 11 1/2 NPTF	16STF16	1397.71	16STF16-SS	\$2352.82
	2" - 11 BSPP	16STBF16	1397.71	---	---
	2 1/2" - 12 ORB	16STOF16	1458.47	---	---



steel



316 stainless

ST-Series Snap-Tite 71 Interchange Female Threaded Plugs

Hydraulic Fittings



steel



316 stainless

Body Size	Threads	Steel		316 Stainless Steel	
		Part #	Price/E	Part #	Price/E
1/4"	1/4" - 18 NPTF	ST2F2	\$51.94	ST2F2-SS	\$118.83
	1/4" - 19 BSPP	ST2BF2	51.94	ST2BF2-SS	118.83
3/8"	1/4" - 18 NPTF	ST3F2	43.63	---	---
	3/8" - 18 NPTF	ST3F3	43.63	ST3F3-SS	124.67
	3/8" - 19 BSPP	ST3BF3	43.63	ST3BF3-SS	124.67
	1/2" - 14 NPTF	ST3F4	43.63	ST3F4-SS	124.67
	1/2" - 14 BSPP	ST3BF4	43.63	ST3BF4-SS	124.67
1/2"	1/2" - 14 NPTF	ST4F4	65.89	ST4F4-SS	138.44
	1/2" - 14 BSPP	ST4BF4	65.89	ST4BF4-SS	138.44
	3/4" - 16 ORB	ST4OF4	68.83	---	---
3/4"	3/4" - 14 NPTF	ST6F6	75.97	ST6F6-SS	309.58
	3/4" - 14 BSPP	ST6BF6	75.97	ST6BF6-SS	309.58
	1-1/16" - 12 ORB	ST6OF6	82.40	---	---
1"	1" - 11 1/2 NPTF	ST8F8	113.03	ST8F8-SS	347.83
	1" - 11 BSPP	ST8BF8	113.03	ST8BF8-SS	347.83
	1-5/16" - 12 ORB	ST8OF8	121.54	---	---
	1 1/4" - 11 1/2 NPTF	ST8F10	154.36	ST8F10-SS	427.22
	1 1/4" - 11 BSPP	ST8BF10	154.36	ST8BF10-SS	427.22
	1 5/8" - 12 ORB	ST8OF10	162.87	---	---

ST-Series Snap-Tite 71 Interchange Old Style Female Threaded Plugs



steel



316 stainless

Body Size	Threads	Steel		316 Stainless Steel	
		Part #	Price/E	Part #	Price/E
1"	1" - 11 1/2 NPTF	ST8F8-V2	\$122.17	---	---
	1" - 11 BSPP	ST8BF8-V2	122.17	---	---
	1 1/4" - 11 1/2 NPTF	ST8F10-V2	136.33	---	---
2"	1 1/2" - 11 1/2 NPTF	ST16F12	751.12	---	---
	1 1/2" - 11 BSPP	ST16BF12	751.12	---	---
	1-7/8" - 12 ORB	ST16OF12	820.40	---	---
	2" - 11 1/2 NPTF	ST16F16	751.12	ST16F16-SS	\$1609.83
	2" - 11 BSPP	ST16BF16	751.12	---	---
	2 1/2" - 12 ORB	ST16OF16	843.59	---	---

ST-Series Snap-Tite 71 Interchange Dust Plugs

Body Size	Aluminum body with steel cable	
	Part #	Price/E
1/4"	2STDP-A	\$10.02
3/8"	3STDP-A	10.76
1/2"	4STDP-A	11.43
3/4"	6STDP-A	33.92
1"	8STDP-A	43.01
1"	8STDP-A-V2	43.01
2"	16STDP-A	103.90



ST-Series Snap-Tite 71 Interchange Dust Caps

Body Size	Aluminum body with steel cable	
	Part #	Price/E
1/4"	ST2DC-A	\$10.02
3/8"	ST3DC-A	10.62
1/2"	ST4DC-A	14.62
3/4"	ST6DC-A	29.26
1"	ST8DC-A	38.07
1"	ST8DC-A-V2	38.07
2"	ST16DC-A	113.11



ST-Series Snap-Tite 71 Interchange Bulkhead Kits

Body Size	Mounting Hole ID	Seal Kit Contents	Steel	
			Part #	Price/E
1/4"	1.250"	two 360° retaining rings	2ST-BMK	\$4.44
3/8"	1.625"	two 360° retaining rings	3ST-BMK	4.86
1/2"	2.000"	two 360° retaining rings	4ST-BMK	5.32
3/4"	2.375"	two 360° retaining rings	6ST-BMK	6.01

ST-Series Snap-Tite 71 Interchange Coupler Seal Kits

Body Size	Coupler Style	Seal Kit Contents	Nitrile	
			Part #	Price/E
1/4"	all	two seals and anti-extrusion rings	2ST-SKIT	\$5.02
3/8"	all	two seals and anti-extrusion rings	3ST-SKIT	5.64
1/2"	all	two seals and anti-extrusion rings	4ST-SKIT	6.12
3/4"	all	two seals and anti-extrusion rings	6ST-SKIT	6.55
1"	all	two seals and anti-extrusion rings	8ST-SKIT	6.72
1"	all	three seals and two anti-extrusion rings	8ST-SKIT-V2	6.72
2"	all	three seals and two anti-extrusion rings	16ST-SKIT	7.91



ST-Series Snap-Tite 71 Interchange Plug Seal Kits

Body Size	Coupler Style	Seal Kit Contents	Nitrile	
			Part #	Price/E
1/4"	all	valve O-ring / back-up and adapter O-ring	ST2-SKIT	\$4.69
3/8"	all	valve O-ring / back-up and adapter O-ring	ST3-SKIT	5.36
1/2"	all	valve O-ring / back-up and adapter O-ring	ST4-SKIT	5.72
3/4"	all	valve O-ring / back-up and adapter O-ring	ST6-SKIT	6.17
1"	all	valve O-ring / back-up and adapter O-ring	ST8-SKIT	6.37
2"	all	main valve seal	ST16-SKIT	7.64

H-BOP Series Hydraulic Couplings

Application:

- designed specifically for blow-out preventer systems on drilling rigs

Features:

- fire tested and Lloyd's certified to **1300°F (700°C)** in accordance with API 16D; certificate available upon request
- pressure rating **5000 PSI at 70°F (21°C)**
- steel coupler sleeves are hardened to resist deformation and maximize service life
- individually marked with the BOP series designation
- interchangeable with ISO7241 Series B, Eaton/Hansen HKFR-Series, DNP HNV-BOP Series

H-BOP Series Blowout Prevention Safety Female Couplers



Body Size	Female Threads	Steel		316 Stainless Steel	
		Part #	Price/E	Part #	Price/E
3/8"	3/8" - 18 NPTF	3HF3-BOP	\$89.26	3HF3-SS-BOP	\$223.15
1/2"	1/2" - 14 NPTF	4HF4-BOP	105.46	4HF4-SS-BOP	339.26
3/4"	3/4" - 14 NPTF	6HF6-BOP	121.42	6HF6-SS-BOP	512.51
1"	1" - 11½ NPTF	8HF8-BOP	154.08	8HF8-SS-BOP	779.59

H-BOP Series Blowout Prevention Safety Female Plugs



Body Size	Female Threads	Steel		316 Stainless Steel	
		Part #	Price/E	Part #	Price/E
3/8"	3/8" - 18 NPTF	H3F3-BOP	\$50.73	H3F3-SS-BOP	\$126.83
1/2"	1/2" - 14 NPTF	H4F4-BOP	65.04	H4F4-SS-BOP	158.80
3/4"	3/4" - 14 NPTF	H6F6-BOP	78.35	H6F6-SS-BOP	223.76
1"	1" - 11½ NPTF	H8F8-BOP	103.04	H8F8-SS-BOP	353.70

E-Series Hydraulic Couplings

Features:

- couplers have no internal valves which provide maximum flow with minimum pressure drop
- Buna-N seal standard, contact Dixon® for additional seal material options.
- Contact Dixon® for pressure ratings and other technical information.
- interchanges with Parker-Hannifin SST/BST, Foster FST and Hansen ST couplings
- *Do not disconnect with pressure in line.*



E-Series Straight Through Interchange Female Threaded Couplers

Body Size	Threads	Previous Part #	Brass		Previous Part #	303 Stainless Steel	
			Part #	Price/E		Part #	Price/E
1/8"	1/8" - 27 NPTF	---	1EF1-B	\$8.37	---	1EF1-S	\$38.88
1/4"	1/4" - 18 NPTF	STFC2	2EF2-B	8.37	STFC2SS	2EF2-S	42.81
	1/4" - 19 BSPP	---	2EBF2-B	9.57	---	---	---
3/8"	3/8" - 18 NPTF	STFC3	3EF3-B	10.33	STFC3SS	3EF3-S	56.68
	3/8" - 19 BSPP	---	3EBF3-B	10.92	---	---	---
1/2"	1/2" - 14 NPTF	STFC4	4EF4-B	14.91	STFC4SS	4EF4-S	64.94
	1/2" - 14 BSPP	---	4EBF4-B	17.21	---	---	---
3/4"	3/4" - 14 NPTF	STFC6	6EF6-B	28.69	STFC6SS	6EF6-S	113.35
	3/4" - 14 BSPP	---	6EBF6-B	29.54	---	---	---
1"	1" - 11 1/2 NPTF	STFC8	8EF8-B	41.30	STFC8SS	8EF8-S	165.30
	1" - 11 BSPP	---	8EBF8-B	45.02	---	---	---
1 1/4"	1 1/4" - 11 1/2 NPTF	STFC10	10EF10-B	111.56	---	10EF10-S	294.22
1 1/2"	1 1/2" - 11 1/2 NPTF	STFC12	12EF12-B	152.90	---	12EF12-S	426.11
2"	2" - 11 1/2 NPTF	STFC16	16EF16-B	210.64	---	16EF16-S	507.29



brass



303 stainless

E-Series Straight Through Interchange Male Threaded Couplers

Body Size	Threads	Previous Part #	Brass		Previous Part #	303 Stainless Steel	
			Part #	Price/E		Part #	Price/E
1/8"	1/8" - 27 NPTF	---	1EM1-B	\$8.37	---	1EM1-S	\$38.88
1/4"	1/4" - 18 NPTF	STMC2	2EM2-B	8.37	STMC2SS	2EM2-S	42.81
3/8"	3/8" - 18 NPTF	STMC3	3EM3-B	10.33	STMC3SS	3EM3-S	56.68
1/2"	1/2" - 14 NPTF	STMC4	4EM4-B	14.91	STMC4SS	4EM4-S	64.94
3/4"	3/4" - 14 NPTF	STMC6	6EM6-B	28.69	STMC6SS	6EM6-S	113.35
1"	1" - 11 1/2 NPTF	STMC8	8EM8-B	41.30	STMC8SS	8EM8-S	165.30
1 1/4"	1 1/4" - 11 1/2 NPTF	STMC10	10EM10-B	111.56	---	---	---
1 1/2"	1 1/2" - 11 1/2 NPTF	STMC12	12EM12-B	152.90	---	---	---
2"	2" - 11 1/2 NPTF	STMC16	16EM16-B	210.64	---	---	---



brass



303 stainless

E-Series Straight Through Interchange Hose Barb Couplers

Body Size	Hose ID	Brass	
		Part #	Price/E
1/4"	1/4"	2ES2-B	\$12.45
3/8"	3/8"	3ES3-B	13.77
1/2"	1/2"	4ES4-B	22.37
3/4"	3/4"	6ES6-B	34.42
1"	1"	8ES8-B	47.04



E-Series Straight Through Interchange Female Threaded Plugs

Hydraulic Fittings



steel



brass

Body Size	Threads	Previous Part #	Steel		Previous Part #	Brass	
			Part #	Price/E		Part #	Price/E
1/8"	1/8" - 27 NPTF	---	E1F1	\$3.31	---	E1F1-B	\$2.75
1/4"	1/4" - 18 NPTF	STFP2	E2F2	2.77	STFP2B	E2F2-B	2.99
	1/4" - 19 BSPP	---	---	---	---	E2BF2-B	3.49
3/8"	3/8" - 18 NPTF	STFP3	E3F3	4.37	STFP3B	E3F3-B	3.50
	3/8" - 19 BSPP	---	---	---	---	E3BF3-B	4.50
1/2"	1/2" - 14 NPTF	STFP4	E4F4	6.14	STFP4B	E4F4-B	6.31
	1/2" - 14 BSPP	---	---	---	---	E4BF4-B	6.76
3/4"	3/4" - 14 NPTF	---	E6F6	14.17	---	E6F6-B	11.25
	3/4" - 14 BSPP	---	---	---	---	E6BF6-B	16.07
1"	1" - 11 1/2 NPTF	STFP8	E8F8	26.56	STFP8B	E8F8-B	24.09
	1" - 11 BSPP	---	---	---	---	E8BF8-B	27.02
1 1/4"	1 1/4" - 11 1/2 NPTF	STFP10	E10F10	61.96	---	E10F10-B	54.02
1 1/2"	1 1/2" - 11 1/2 NPTF	STFP12	E12F12	99.61	---	E12F12-B	87.79
2"	2" - 11 1/2 NPTF	STFP16	E16F16	127.41	---	E16F16-B	119.30



Body Size	Threads	Previous Part #	303 Stainless Steel	
			Part #	Price/E
1/8"	1/8" - 27 NPTF	---	E1F1-S	\$19.60
1/4"	1/4" - 18 NPTF	STFP2SS	E2F2-S	17.29
3/8"	3/8" - 18 NPTF	STFP3SS	E3F3-S	23.62
1/2"	1/2" - 14 NPTF	STFP4SS	E4F4-S	33.54
3/4"	3/4" - 14 NPTF	---	E6F6-S	44.87
1"	1" - 11 1/2 NPTF	STFP8SS	E8F8-S	82.66
1 1/4"	1 1/4" - 11 1/2 NPTF	---	E10F10-S	139.00
1 1/2"	1 1/2" - 11 1/2 NPTF	---	E12F12-S	243.24
2"	2" - 11 1/2 NPTF	---	E16F16-S	312.74

E-Series Straight Through Interchange Male Threaded Plugs



steel



brass

Body Size	Threads	Previous Part #	Steel		Previous Part #	Brass	
			Part #	Price/E		Part #	Price/E
1/8"	1/8" - 27 NPTF	---	E1M1	\$3.78	---	E1M1-B	\$2.75
1/4"	1/4" - 18 NPTF	STMP2	E2M2	2.77	STMP2B	E2M2-B	2.99
3/8"	3/8" - 18 NPTF	STMP3	E3M3	4.37	STMP3B	E3M3-B	3.50
1/2"	1/2" - 14 NPTF	STMP4	E4M4	6.14	STMP4B	E4M4-B	6.31
3/4"	3/4" - 14 NPTF	STMP6	E6M6	14.17	STMP6B	E6M6-B	11.25
1"	1" - 11 1/2 NPTF	STMP8	E8M8	26.56	STMP8B	E8M8-B	24.09
1 1/4"	1 1/4" - 11 1/2 NPTF	STMP10	E10M10	69.49	---	E10M10-B	61.90
1 1/2"	1 1/2" - 11 1/2 NPTF	STMP12	E12M12	99.61	---	E12M12-B	87.79
2"	2" - 11 1/2 NPTF	STMP16	E16M16	133.20	---	E16M16-B	120.43



Body Size	Threads	Previous Part #	303 Stainless	
			Part #	Price/E
1/8"	1/8" - 27 NPTF	---	E1M1-S	\$19.60
1/4"	1/4" - 18 NPTF	STMP2SS	E2M2-S	17.29
3/8"	3/8" - 18 NPTF	STMP3SS	E3M3-S	23.62
1/2"	1/2" - 14 NPTF	STMP4SS	E4M4-S	33.54
3/4"	3/4" - 14 NPTF	STMP6SS	E6M6-S	44.87
1"	1" - 11 1/2 NPTF	STMP8SS	E8M8-S	82.66

E-Series Straight Through Interchange Hose Barb Plugs

Body Size	Hose ID	Steel		Brass	
		Part #	Price/E	Part #	Price/E
1/4"	1/4"	E2S2	\$6.03	E2S2-B	\$5.16
3/8"	3/8"	E3S3	7.80	E3S3-B	6.31
1/2"	1/2"	E4S4	14.65	E4S4-B	12.05
3/4"	3/4"	E6S6	18.53	E6S6-B	15.78
1"	1"	E8S8	37.07	E8S8-B	34.42



steel



brass

Hydraulic Fittings

E-Series Straight Through Interchange Coupler Seal Kits

Body Size	Coupler Style	Seal Material	Seal Kit Contents	Nitrile		FKM		EPDM	
				Part #	Price/E	Part #	Price/E	Part #	Price/E
1/4"	all	nitrile	body O-ring	2E-SKIT	\$0.90	F-2E-SKIT	\$1.02	P-2E-SKIT	\$1.12
3/8"	all	nitrile	body O-ring	3E-SKIT	0.90	F-3E-SKIT	1.02	P-3E-SKIT	1.12
1/2"	all	nitrile	body O-ring	4E-SKIT	1.13	F-4E-SKIT	1.78	P-4E-SKIT	1.78
3/4"	all	nitrile	body O-ring	6E-SKIT	1.18	F-6E-SKIT	1.87	P-6E-SKIT	1.87
1"	all	nitrile	body O-ring	8E-SKIT	1.63	F-8E-SKIT	2.01	P-8E-SKIT	2.01
1 1/4"	all	nitrile	body O-ring	10E-SKIT	1.63	F-10E-SKIT	2.28	P-10E-SKIT	2.28
1 1/2"	all	nitrile	body O-ring	12E-SKIT	2.04	F-12E-SKIT	2.50	P-12E-SKIT	2.50
2"	all	nitrile	body O-ring	16E-SKIT	3.22	F-16E-SKIT	3.05	P-16E-SKIT	3.05

E-Series Plug Profile Chart

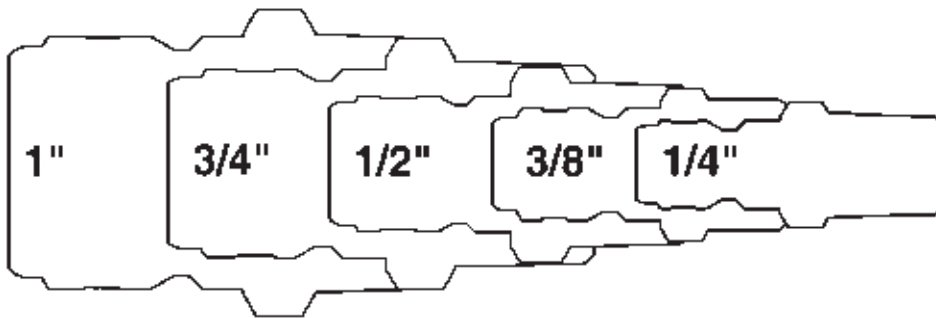

Industry/Competitor Interchange

Perfecting E Series
Parker ST
Hansen ST



EA-Series Hydraulic Couplings

Features:

- plug mounted sleeve guard protects against accidental disconnection
- smooth bore full-flow design ensures maximum flow with minimal pressure drop
- steel body components maximize service life by resisting the effects of brinelling and internal erosion
- heavy duty knurled sleeve with locking pin provides maximum protection against brinelling and accidental disconnection
- interchangeable with Parker WB, Aeroquip FD69, and Snap Tite 56
- pressure rating **10000 PSI at 70°F (21°C)**



EA-Series Water-Blast Interchange Couplers

Body Size	Female Threads	Steel	
		Part #	Price/E
1/2"	3/8" - 18 NPTF	4EAF3	\$125.17
1/2"	1/2" - 14 NPTF	4EAF4	125.17

EA-Series Water-Blast Interchange Plugs



Body Size	Female Threads	Steel	
		Part #	Price/E
1/2"	3/8" - 18 NPTF	EA4F3	\$34.88
1/2"	1/2" - 14 NPTF	EA4F4	34.88

EA-Series Water-Blast Interchange Seal Kits

Body Size	Coupler Style	Seal Kit Contents	Nitrile	
			Part #	Price/E
1/2"	all	body O-ring and PTFE back-up	4EA-SKIT	\$5.47

Body Size	Coupler Style	Seal Kit Contents	FKM	
			Part #	Price/E
1/2"	all	body O-ring and PTFE back-up	F-4EA-SKIT	\$6.46

Body Size	Coupler Style	Seal Kit Contents	EPDM	
			Part #	Price/E
1/2"	all	body O-ring and PTFE back-up	P-4EA-SKIT	\$6.46

W-Series Hydraulic Couplings

Applications:

- Designed for applications requiring a coupling that can be connected under residual pressure with minimum spillage and air inclusion. Widely used on dump trailer wet-line hydraulic systems and oil field equipment. Not recommended for continuous hydraulic impulse applications.

Features:

- interchangeable with Aeroquip 5100 series, Parker 6100 series and Snap-Tite 78 series
- Contact Dixon® for pressure ratings and other technical information.

W-Series Wingstyle Interchange Female Threaded Couplers

Body Size	Threads	Previous Part #	Brass		Steel	
			Part #	Price/E	Part #	Price/E
1/4"	1/8" NPTF	---	2WF1-B	151.31	---	---
3/8"	1/4" NPTF	---	3WF2-B	130.85	---	---
	3/8" NPTF	---	3WF3-B	130.85	---	---
3/4"	1/2" - 14 NPTF	---	6WF4-B	79.57	---	---
	1/2" - 14 BSPP	---	6WBF4-B	74.26	---	---
	3/4" - 14 NPTF	78-600	6WF6-B	79.57	---	---
	3/4" - 14 BSPP	---	6WBF6-B	95.48	---	---
1"	1" - 11 1/2 NPTF	78-800	8WF8-B	97.60	8WF8	\$100.79
	1" - 11 BSPP	---	8WBF8-B	97.60	---	---
1 1/4"	1 1/4" - 11 1/2 NPTF	78-1000	10WF10-B	178.23	---	---
	1 1/4" - 11 BSPP	---	10WBF10-B	188.49	---	---
1 1/2"	1 1/2" - 11 1/2 NPTF	78-1200	12WF12-B	212.18	---	---
	1 1/2" - 11 BSPP	---	12WBF12-B	228.09	---	---

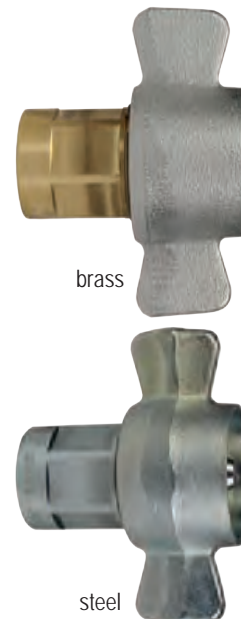

brass

steel

W-Series Wingstyle Interchange Hex-Nut Female Threaded Couplers

Body Size	Threads	Brass		Steel	
		Part #	Price/E	Part #	Price/E
1/4"	1/8" NPTF	2WF1-B-HN	151.31	---	---
3/8"	1/4" NPTF	3WF2-B-HN	130.85	---	---
	3/8" NPTF	3WF3-B-HN	130.85	---	---
3/4"	1/2" - 14 NPTF	6WF4-B-HN	79.57	---	---
	1/2" - 14 BSPP	6WBF4-B-HN	95.48	---	---
	3/4" - 14 NPTF	6WF6-B-HN	79.57	---	---
	3/4" - 14 BSPP	6WBF6-B-HN	95.48	---	---
1"	1" - 11 1/2 NPTF	8WF8-B-HN	97.60	8WF8-HN	\$113.52
	1" - 11 BSPP	8WBF8-B-HN	113.52	---	---
1 1/4"	1 1/4" - 11 1/2 NPTF	10WF10-B-HN	178.23	---	---
	1 1/4" - 11 BSPP	10WBF10-B-HN	188.49	---	---
1 1/2"	1 1/2" - 11 1/2 NPTF	12WF12-B-HN	212.18	---	---
	1 1/2" - 11 BSPP	12WBF12-B-HN	228.09	---	---



brass

steel

W-Series Wingstyle Interchange Female Threaded Plugs

Hydraulic Fittings

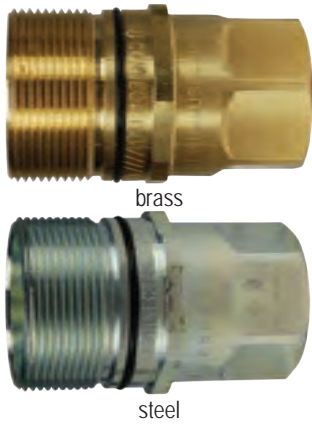

Body Size	Threads	Previous Part #	Brass		Steel	
			Part #	Price/E	Part #	Price/E
1/4"	1/8" NPTF	---	W2F1-B	\$79.12	---	---
3/8"	1/4" NPTF	---	W3F2-B	89.04	---	---
	3/8" NPTF	---	W3F3-B	89.04	---	---
3/4"	1/2" - 14 NPTF	---	W6F4-B	56.23	---	---
	1/2" - 14 BSPP	---	W6BF4-B	72.14	---	---
	3/4" - 14 NPTF	79-600	W6F6-B	56.23	---	---
	3/4" - 14 BSPP	---	W6BF6-B	72.14	---	---
1"	1" - 11 1/2 NPTF	79-800	W8F8-B	60.47	W8F8	\$63.65
	1" - 11 BSPP	---	W8BF8-B	76.38	---	---
1 1/4"	1 1/4" - 11 1/2 NPTF	79-1000	W10F10-B	125.19	---	---
	1 1/4" - 11 BSPP	---	W10BF10-B	141.10	---	---
1 1/2"	1 1/2" - 11 1/2 NPTF	79-1200	W12F12-B	212.18	---	---
	1 1/2" - 11 BSPP	---	W12BF12-B	228.09	---	---

W-Series Wingstyle Interchange Flanges



Body Size	Bolt Hole Size	Previous Part #	Steel	
			Part #	Price/E
3/4"	0.201"	77-600	W6-BMF	\$4.77
1"	0.201"	77-800	W8-BMF	6.37
1 1/4"	0.201"	77-1000	W10-BMF	8.49
1 1/2"	0.201"	77-1200	W12-BMF	10.61

W-Series Wingstyle Interchange Dust Plugs



Body Size	Previous Part #	Steel body with steel cable	
		Part #	Price/E
1/4"	---	2WDP	\$25.44
3/8"	---	3WDP	27.81
3/4"	78-006	6WDP	18.23
1"	78-008	8WDP	20.09
1 1/4"	78-010	10WDP	28.84
1 1/2"	78-012	12WDP	51.50

W-Series Wingstyle Interchange Dust Caps



Body Size	Previous Part #	Steel body with steel cable	
		Part #	Price/E
1/4"	---	W2DC	\$25.31
3/8"	---	W3DC	23.88
3/4"	79-006	W6DC	16.07
1"	79-008	W8DC	17.51
1 1/4"	79-010	W10DC	27.19
1 1/2"	79-012	W12DC	47.38

W-Series Wingstyle Interchange Coupler Repair Kits

Body Size	Coupler Style	Seal Kit Contents	Nitrile	
			Part #	Price/E
3/4"	all	bonded valve, O-rings, and PTFE backup	6W-RKIT-V2	\$29.52
1"	all	bonded valve, O-rings, and PTFE backup	8W-RKIT-V2	33.85
1 1/4"	all	bonded valve, O-rings, and PTFE backup	10W-RKIT-V2	35.54
1 1/2"	all	bonded valve, O-rings, and PTFE backup	12W-RKIT-V2	37.36



W-Series Wingstyle Interchange Plug Repair Kits

Body Size	Coupler Style	Seal Kit Contents	Nitrile	
			Part #	Price/E
3/4"	all	valve assembly and O-ring	W6-RKIT-V2	\$9.92
1"	all	valve assembly and O-ring	W8-RKIT-V2	10.42
1 1/4"	all	valve assembly and O-ring	W10-RKIT-V2	18.06
1 1/2"	all	valve assembly and O-ring	W12-RKIT-V2	36.36



W-Series Profile Chart

Industry/Competitor Interchange

Aeroquip 5100
Parker 6100

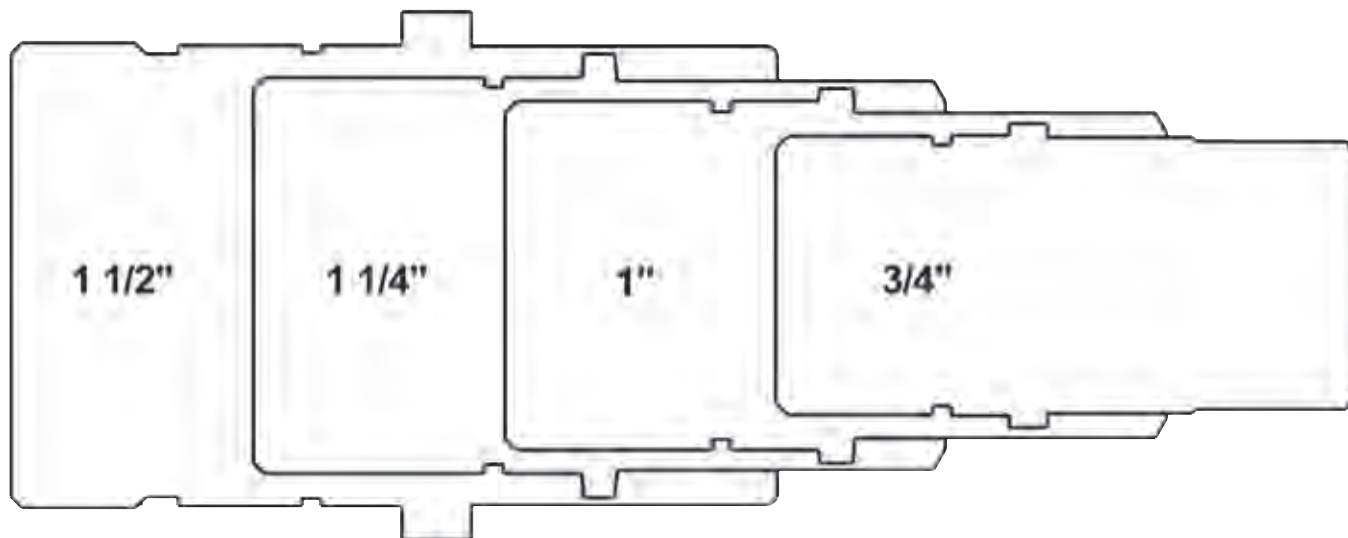

WS-Series Hydraulic Couplings

Application:

- used extensively in oil field and off shore oil rig applications

Feature:

- interchanges with Snap-Tite 75 series
- Contact Dixon® for pressure ratings and other technical information.

WS-Series High Pressure Wingstyle Interchange Female Threaded Couplers

steel



316 stainless

Body Size	Threads	Steel		316 Stainless Steel	
		Part #	Price/E	Part #	Price/E
¾"	½" - 14 NPTF	6WSF4	\$152.01	---	---
	¾" - 14 NPTF	6WSF6	147.67	6WSF6-SS	\$1339.25
	¾" - 14 BSPP	6WSBF6	147.67	6WSBF6-SS	1674.06
	1-1/16" - 12 ORB	6WSOF6	162.87	---	---
1"	1" - 11½ NPTF	8WSF8	221.50	8WSF8-SS	1510.95
	1" - 11 BSPP	8WSBF8	221.50	8WSBF8-SS	1888.68
	1-5/16" - 12 ORB	8WSOF8	249.73	---	---
1¼"	1¼" - 11½ NPTF	10WSF10	374.59	10WSF10-SS	2472.46
	1¼" - 11 BSPP	10WSBF10	374.59	10WSBF10-SS	3090.58
	1½" - 12 ORB	10WSOF10	401.74	---	---
1½"	1½" - 11½ NPTF	12WSF12	553.74	12WSF12-SS	3021.90
	1½" - 11 BSPP	12WSBF12	553.74	12WSBF12-SS	3021.90
	1⅞" - 12 ORB	12WSOF12	597.17	---	---
2"	2" - 11½ NPTF	16WSF16	750.89	16WSF16-SS	3914.74
	2" - 11 BSPP	16WSBF16	792.60	16WSBF16-SS	3914.74
	2½" - 12 ORB	16WSOF16	819.76	---	---

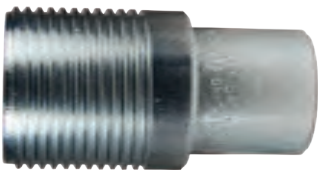
WS-Series High Pressure Wingstyle Interchange Female Threaded Plugs

steel



316 stainless

Body Size	Threads	Steel		316 Stainless Steel	
		Part #	Price/E	Part #	Price/E
¾"	½" - 14 NPTF	WS6F4	\$140.06	---	---
	¾" - 14 NPTF	WS6F6	135.72	WS6F6-SS	\$1098.87
	¾" - 14 BSPP	WS6BF6	135.72	WS6BF6-SS	1373.59
	1-1/16" - 12 ORB	WS6OF6	157.43	---	---
1"	1" - 11½ NPTF	WS8F8	162.87	WS8F8-SS	1236.24
	1" - 11 BSPP	WS8BF8	162.87	WS8BF8-SS	1545.29
	1-5/16" - 12 ORB	WS8OF8	190.00	---	---
1¼"	1¼" - 11½ NPTF	WS10F10	298.59	WS10F10-SS	1579.63
	1¼" - 11 BSPP	WS10BF10	298.59	WS10BF10-SS	1974.54
	1½" - 12 ORB	WS10OF10	325.73	---	---
1½"	1½" - 11½ NPTF	WS12F12	442.31	WS12F12-SS	1923.03
	1½" - 11 BSPP	WS12BF12	466.88	WS12BF12-SS	1923.03
	1⅞" - 12 ORB	WS12OF12	488.59	---	---
2"	2" - 11½ NPTF	WS16F16	720.03	WS16F16-SS	2541.14
	2" - 11 BSPP	WS16BF16	760.03	WS16BF16-SS	2541.14
	2½" - 12 ORB	WS16OF16	792.60	---	---

WS-Series High Pressure Wingstyle Interchange Dust Plugs

Body Size	Aluminum body with steel cable	
	Part #	Price/E
¾"	6WSDP-A	\$39.31
1"	8WSDP-A	50.40
1¼"	10WSDP-A	70.55
1½"	12WSDP-A	75.59
2"	16WSDP-A	125.98



WS-Series High Pressure Wingstyle Interchange Dust Caps

Body Size	Aluminum body with steel cable	
	Part #	Price/E
¾"	WS6DC-A	\$39.31
1"	WS8DC-A	50.40
1¼"	WS10DC-A	70.55
1½"	WS12DC-A	75.59
2"	WS16DC-A	125.98



WS-Series High Pressure Wingstyle Interchange Seal Kits

Body Size	Coupler Style	Seal Kit Contents	Nitrile	
			Part #	Price/E
¾"	all	body / valve seals and retaining rings	6WS-SKIT	\$11.88
1"	all	body / valve seals and retaining rings	8WS-SKIT	13.34
1¼"	all	body / valve seals and retaining rings	10WS-SKIT	16.01
1½"	all	body / valve seals and retaining rings	12WS-SKIT	19.20
2"	all	body / valve seals and retaining rings	16WS-SKIT	20.26



WS-Series High Pressure Wingstyle Interchange Repair Kits

Body Size	Coupler Style	Repair Kit Contents	Nitrile	
			Part #	Price/E
¾"	all	valve assembly, O-ring, and PTFE B.U.	6WS-RKIT	\$47.79
1"	all	valve assembly, O-ring, and PTFE B.U.	8WS-RKIT	77.04
1¼"	all	valve assembly, O-ring, and PTFE B.U.	10WS-RKIT	83.31
1½"	all	valve assembly, O-ring, and PTFE B.U.	12WS-RKIT	89.62
2"	all	valve assembly, O-ring, and PTFE B.U.	16WS-RKIT	150.48



WS-BOP Series Hydraulic Couplings

Applications:

- designed for use in oil rig BOP systems where couplings are required to operate under fire conditions in an emergency

Features:

- fire tested and Lloyd's certified to **1300°F (700°C)** in accordance with API 16D (Certificate #NAO 0601041/1)
- Contact Dixon® for pressure ratings and other technical information.
- Sleeve is cast using a process that provides better surface finishes, tighter tolerance control, and excellent repeatability.
- Blowout Prevention Couplings are individually marked with the BOP series designation.

WS-BOP Series High Pressure Wingstyle Female Threaded Couplers



Body Size	Threads	Steel		316 Stainless Steel	
		Part #	Price/E	Part #	Price/E
¾"	½" - 14 NPTF	6WSF4-BOP	\$164.17	---	---
	¾" - 14 NPTF	6WSF6-BOP	159.48	6WSF6-SS-BOP	\$1579.63
1"	1" - 11½ NPTF	8WSF8-BOP	239.22	8WSF8-SS-BOP	1648.31
1¼"	1¼" - 11½ NPTF	10WSF10-BOP	404.56	10WSF10-SS-BOP	2843.33
1½"	1½" - 11½ NPTF	12WSF12-BOP	598.04	12WSF12-SS-BOP	3475.19
2"	2" - 11½ NPTF	16WSF16-BOP	788.43	16WSF16-SS-BOP	5606.05

WS-BOP Series High Pressure Wingstyle Female Threaded Plugs

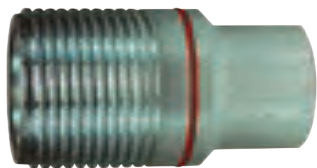

Body Size	Threads	Steel		316 Stainless Steel	
		Part #	Price/E	Part #	Price/E
¾"	½" - 14 NPTF	WS6F4-BOP	\$151.26	---	---
	¾" - 14 NPTF	WS6F6-BOP	156.58	WS6F6-SS-BOP	\$1304.91
1"	1" - 11½ NPTF	WS8F8-BOP	175.90	WS8F8-SS-BOP	1510.95
1¼"	1¼" - 11½ NPTF	WS10F10-BOP	332.48	WS10F10-SS-BOP	1809.68
1½"	1½" - 11½ NPTF	WS12F12-BOP	464.43	WS12F12-SS-BOP	2211.48
2"	2" - 11½ NPTF	WS16F16-BOP	756.03	WS16F16-SS-BOP	3639.01

WS-BOP Series High Pressure Wingstyle Interchange Seal Kits



Body Size	Coupler Style	Repair Kit Contents	FR FKM	
			Part #	Price/E
¾"	all	body / valve seals and retaining rings	6BOP-SKIT	\$18.60
1"	all	body / valve seals and retaining rings	8BOP-SKIT	20.87
1¼"	all	body / valve seals and retaining rings	10BOP-SKIT	22.54
1½"	all	body / valve seals and retaining rings	12BOP-SKIT	23.26
2"	all	body / valve seals and retaining rings	16BOP-SKIT	25.87

VEP-Series Hydraulic Couplings

Features:

- no-spill, flush face valve minimizes air inclusion during connection and spillage during disconnection
- thread-to-connect design and dual valve system in the plug allow for connecting under pressure
- design eliminates premature wear or brinelling commonly found with locking ball designs when subjected to high impulse pressures
- Zinc nickel plating provides corrosion resistance
- interchangeable with Parker FET, Stucchi VEP, DNP FSI, Holmbury HFT
- Contact Dixon® for pressure ratings and other technical information.

VEP-Series Female Threaded Couplers

Body Size	Threads	Steel	
		Part #	Price/E
¼"	¼" - 18 NPTF	2VEPF2	\$108.77
	¼" - 19 BSPP	2VEPBF2	108.77
	9/16" - 18 ORB	2VEPOF3	119.65
⅜"	⅜" - 18 NPTF	3VEPF3	121.80
	⅜" - 19 BSPP	3VEPBF3	123.36
	¾" - 16 ORB	3VEPOF4	126.54
	½" - 14 NPTF	3VEPF4	124.53
	½" - 14 BSPP	3VEPBF4	123.36
½"	½" - 14 NPTF	4VEPF4	158.55
	½" - 14 BSPP	4VEPBF4	162.99
	¾" - 16 ORB	4VEPOF4	164.69
	⅞" - 14 ORB	4VEPOF5	164.69
	¾" - 14 NPTF	4VEPF6	162.65
	¾" - 14 BSPP	4VEPBF6	162.99
	1-1/16" - 12 ORB	4VEPOF6	164.69
¾"	¾" - 14 NPTF	6VEPF6	206.17
	¾" - 14 BSPP	6VEPBF6	211.11
	1-1/16" - 12 ORB	6VEPOF6	206.17
1"	1" - 11½ NPTF	8VEPF8	261.27
	1" - 11 BSPP	8VEPBF8	265.86
	1-5/16" - 12 ORB	8VEPOF8	263.30
1¼"	1¼" - 11½ NPTF	10VEPF10	302.10
	1¼" - 11 BSPP	10VEPBF10	316.90
	1-⅝" - 12 ORB	10VEPOF10	305.27
1½"	1½" - 11½ NPTF	12VEPF12	866.42
	1½" - 11 BSPP	12VEPBF12	919.16
	1-⅞" - 12 ORB	12VEPOF12	885.01
2"	2" - 11½ NPTF	16VEPF16	2978.76
	2" - 11 BSPP	16VEPBF16	3535.55
	2½" - 12 ORB	16VEPOF16	2978.76



VEP-Series Female Threaded Plugs



Body Size	Threads	Steel	
		Part #	Price/E
1/4"	1/4" - 18 NPTF	VEP2F2	\$102.09
	1/4" - 19 BSPP	VEP2BF2	102.09
	9/16" - 18 ORB	VEP2OF3	112.30
3/8"	3/8" - 18 NPTF	VEP3F3	138.15
	3/8" - 19 BSPP	VEP3BF3	141.26
	3/4" - 16 ORB	VEP3OF4	142.92
	1/2" - 14 NPTF	VEP3F4	140.86
	1/2" - 14 BSPP	VEP3BF4	141.26
1/2"	1/2" - 14 NPTF	VEP4F4	158.55
	1/2" - 14 BSPP	VEP4BF4	162.99
	3/4" - 16 ORB	VEP4OF4	164.69
	7/8" - 14 ORB	VEP4OF5	164.69
	3/4" - 14 NPTF	VEP4F6	162.65
	3/4" - 14 BSPP	VEP4BF6	162.99
	1-1/16" - 12 ORB	VEP4OF6	164.69
3/4"	3/4" - 14 NPTF	VEP6F6	185.76
	3/4" - 14 BSPP	VEP6BF6	190.70
	1-1/16" - 12 ORB	VEP6OF6	185.76
1"	1" - 11 1/2 NPTF	VEP8F8	214.34
	1" - 11 BSPP	VEP8BF8	221.73
	1-5/16" - 12 ORB	VEP8OF8	216.35
1 1/4"	1 1/4" - 11 1/2 NPTF	VEP10F10	302.10
	1 1/4" - 11 BSPP	VEP10BF10	316.90
	1-5/8" - 12 ORB	VEP10OF10	305.27
1 1/2"	1 1/2" - 11 1/2 NPTF	VEP12F12	828.15
	1 1/2" - 11 BSPP	VEP12BF12	877.85
	1-7/8" - 12 ORB	VEP12OF12	847.80
2"	2" - 11 1/2 NPTF	VEP16F16	2214.99
	2" - 11 BSPP	VEP16BF16	2347.39
	2 1/2" - 12 ORB	VEP16OF16	2214.99

VEP-Series Dust Plugs



Body Size	Aluminum body with steel cable	
	Part #	Price/E
1/4"	2VEPDP-A	\$27.01
3/8"	3VEPDP-A	31.03
1/2"	4VEPDP-A	48.55
3/4"	6VEPDP-A	51.29
1"	8VEPDP-A	52.62
1 1/4"	10VEPDP-A	53.98
1 1/2"	12VEPDP-A	134.90
2"	16VEPDP-A	197.61

VEP-Series Dust Caps



Body Size	Aluminum body with steel cable	
	Part #	Price/E
1/4"	VEP2DC-A	\$28.34
3/8"	VEP3DC-A	36.42
1/2"	VEP4DC-A	51.29
3/4"	VEP6DC-A	53.98
1"	VEP8DC-A	59.36
1 1/4"	VEP10DC-A	56.66
1 1/2"	VEP12DC-A	172.68
2"	VEP16DC-A	262.71

VEP-BOP Series Hydraulic Couplings

Features:

- red powder coated components and external O-rings for easy BOP service identification
- steel components are plated using ROHS compliant zinc nickel
- interchangeable with VEP/VEP-HD Series, DNP FSI-BOP Series
- pressure rating **5000 PSI at 70°F (21°C)**

VEP-BOP Series Blowout Preventer Safety Female Threaded Couplers

Body Size	Threads	Steel	
		Part #	Price/E
3/8"	3/8" - 18 NPTF	3VEPF3-BOP	\$140.07
1/2"	1/2" - 14 NPTF	4VEPF4-BOP	182.33
3/4"	3/4" - 14 NPTF	6VEPF6-BOP	237.10
1"	1" - 11 1/2 NPTF	8VEPF8-BOP	300.46
1 1/4"	1 1/4" - 11 1/2 NPTF	10VEPF10-BOP	347.42
1 1/2"	1 1/2" - 11 1/2 NPTF	12VEPF12-BOP	996.38



VEP-BOP Series Blowout Preventer Safety Female Threaded Plugs

Body Size	Threads	Steel	
		Part #	Price/E
3/8"	3/8" - 18 NPTF	VEP3F3-BOP	\$158.87
1/2"	1/2" - 14 NPTF	VEP4F4-BOP	182.33
3/4"	3/4" - 14 NPTF	VEP6F6-BOP	213.62
1"	1" - 11 1/2 NPTF	VEP8F8-BOP	246.49
1 1/4"	1 1/4" - 11 1/2 NPTF	VEP10F10-BOP	347.42
1 1/2"	1 1/2" - 11 1/2 NPTF	VEP12F12-BOP	952.37



T-Series Hydraulic Couplings

Applications:

- Designed for extreme high pressure applications including hydraulic rams and pumps where low flow and pressures up to 10,000 PSI are encountered.

Features:

- interchangeable with Parker 3000 and Enerpac C 604
- polyurethane seals
- both poppet valve and ball valve styles available

T-Series Enerpac Interchange Female NPTF Ball Coupler

Body Size	Threads	Previous Part #	Steel		Price/E
			Part #		
3/8"	3/8" - 18 NPTF	30-300F	3TF3		\$32.21

T-Series Enerpac Interchange Male NPTF Ball Couplers

Body Size	Threads	Previous Part #	Steel		Threads	316 Stainless Steel	
			Part #	Price/E		Part #	Price/E
1/4"	1/4" - 18 NPTF	30-200	2TM2	\$29.19	---	---	---
3/8"	3/8" - 18 NPTF	30-300	3TM3	32.21	3/8" - 18 NPT	3TM3-SS	\$198.34

T-Series Enerpac Interchange Male NPTF Poppet Couplers

Body Size	Threads	Steel		316 Stainless Steel	
		Part #	Price/E	Part #	Price/E
3/8"	3/8" - 18 NPT	3TM3-PV	\$49.16	3TM3-SS-PV	\$228.69

T-Series Enerpac Interchange Female NPTF Ball Plugs

Body Size	Threads	Previous Part #	Steel		Threads	316 Stainless Steel	
			Part #	Price/E		Part #	Price/E
1/4"	1/4" - 18 NPTF	31-200	T2F2	\$17.52	---	---	---
3/8"	3/8" - 18 NPTF	31-300	T3F3	18.45	3/8" - 18 NPT	T3F3-SS	\$109.66

T-Series Enerpac Interchange Female NPTF Poppet Plugs

Body Size	Threads	Steel		316 Stainless Steel	
		Part #	Price/E	Part #	Price/E
3/8"	3/8" - 18 NPT	T3F3-PV	\$27.68	T3F3-SS-PV	\$126.57

T-Series Enerpac Interchange Dust Plugs

Body Size	Previous Part #	<i>Steel body with rubber lanyard</i>	
		Part #	Price/E
1/4"	30-200DP	2TDP	\$7.50
3/8"	30-300DP	3TDP	7.50



T-Series Enerpac Interchange Dust Caps

Body Size	Previous Part #	<i>Steel body with steel cable</i>	
		Part #	Price/E
1/4"	31-200DC	T2DC	\$11.65
3/8"	31-300DC	T3DC	11.65



T-Series Enerpac Interchange Ball Coupler Seal Kits

Body Size	Coupler Style	Seal Kit Contents	<i>Urethane</i>	
			Part #	Price/E
1/4"	ball valve	body seal	2T-SKIT	\$3.86
3/8"	ball valve	body seal	3T-SKIT	4.23



T-Series Plug Profile Chart

Industry/Competitor Interchange

Parker 3000
Enerpac C604

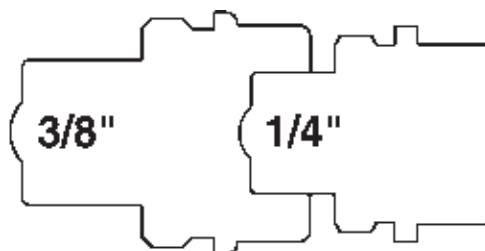

TR-Series Hydraulic Couplings

Features:

- interchangeable with TEMA European, 3800, 5000, 7500, 10000 series
- nitrile seals
- valve seals are crimped in place to maintain integrity during excessive flow conditions and pressurized connection
- Contact Dixon® for pressure ratings and other technical information.

TR-Series Tema European Interchange Female Threaded Couplers



Body Size	Threads	Steel	
		Part #	Price/E
3/8"	3/8" - 18 NPTF	3TRF3	\$85.23
	3/8" - 19 BSPP	3TRBF3	85.23
1/2"	1/2" - 14 NPTF	4TRF4	101.21
	1/2" - 14 BSPP	4TRBF4	101.21
3/4"	3/4" - 14 NPTF	6TRF6	129.99
	3/4" - 14 BSPP	6TRBF6	129.99
1"	1" - 11 1/2 NPTF	8TRF8	196.76
	1" - 11 BSPP	8TRBF8	196.76

TR-Series Tema European Interchange Female Threaded Plugs



Body Size	Threads	Steel	
		Part #	Price/E
3/8"	3/8" - 18 NPTF	TR3F3	\$31.00
	3/8" - 19 BSPP	TR3BF3	31.00
1/2"	1/2" - 14 NPTF	TR4F4	35.74
	1/2" - 14 BSPP	TR4BF4	35.74
3/4"	3/4" - 14 NPTF	TR6F6	56.93
	3/4" - 14 BSPP	TR6BF6	56.93
1"	1" - 11 1/2 NPTF	TR8F8	84.16
	1" - 11 BSPP	TR8BF8	84.16

TR-Series Tema European Interchange Coupler Seal Kits



Body Size	Coupler Style	Seal Kit Contents	Nitrile	
			Part #	Price/E
3/8"	all	two O-rings and one PTFE back-up ring	3TR-SKIT	\$4.88
1/2"	all	two O-rings and one PTFE back-up ring	4TR-SKIT	5.67
3/4"	all	two O-rings and one PTFE back-up ring	6TR-SKIT	7.51
1"	all	two O-rings and one PTFE back-up ring	8TR-SKIT	9.98

CVV-Series Hydraulic Couplings

Features:

- nitrile (Buna-N) seals are standard, providing a temperature range of **-13°F to 257°F** (**-25°C to 125°C**)
- Contact Dixon® for pressure ratings and other technical information.
- interchangeable with European Screw-Together, Inteva STG-Series, Faster CVV-Series, DNP PVV3, Voswinkel Type-HS

CVV-Series European Interchange Female Threaded Couplers

Body Size	Threads	Steel	
		Part #	Price/E
1/4"	1/4" - 18 NPTF	2CVVF2	\$57.76
	1/4" - 19 BSPP	2CVVBF2	57.76
	M14X1.5	2CVVFM1415	57.76
3/8"	3/8" - 18 NPTF	3CVVF3	57.76
	3/8" - 19 BSPP	3CVVBF3	57.76
	M16X1.5	3CVVFM1615	57.76
1/2"	1/2" - 14 NPTF	4CVVF4	65.83
	3/4" - 16 ORB	4CVVOF4	65.83
	1/2" - 14 BSPP	4CVVBF4	65.83
	M18X1.5	4CVVFM1815	65.83
	7/8" - 14 ORB	4CVVOF5	65.83
	M22X1.5	4CVVFM2215	65.83
3/4"	3/4" - 14 NPTF	6CVVF6	101.37
	3/4" - 14 BSPP	6CVVBF6	101.37
	M22X1.5	6CVVFM2215	101.37
1"	1" - 11 1/2 NPTF	8CVVF8	140.35
	1" - 11 BSPP	8CVVBF8	140.35
1 1/4"	1 1/4" - 11 1/2 NPTF	10CVVF10	431.22
	1 1/4" - 11 BSPP	10CVVBF10	431.22



CVV-Series European Interchange Female Threaded Plugs

Body Size	Threads	Steel	
		Part #	Price/E
1/4"	1/4" - 18 NPTF	CVV2F2	\$40.39
	1/4" - 19 BSPP	CVV2BF2	40.39
	M14X1.5	CVV2FM1415	40.39
3/8"	3/8" - 18 NPTF	CVV3F3	40.39
	3/8" - 19 BSPP	CVV3BF3	40.39
	M16X1.5	CVV3FM1615	40.39
1/2"	1/2" - 14 NPTF	CVV4F4	52.61
	3/4" - 16 ORB	CVV4OF4	52.61
	1/2" - 14 BSPP	CVV4BF4	52.61
	M18X1.5	CVV4FM1815	52.61
	7/8" - 14 ORB	CVV4OF5	52.61
	M22X1.5	CVV4FM2215	52.61
3/4"	3/4" - 14 NPTF	CVV6F6	88.37
	3/4" - 14 BSPP	CVV6BF6	88.37
	M22X1.5	CVV6FM2215	88.37
1"	1" - 11 1/2 NPTF	CVV8F8	127.36
	1" - 11 BSPP	CVV8BF8	127.36
1 1/4"	1 1/4" - 11 1/2 NPTF	CVV10F10	316.45
	1 1/4" - 11 BSPP	CVV10BF10	316.45



CVV-Series European Interchange Dust Plugs

Hydraulic Fittings



Body Size	Plastic	
	Part #	Price/E
1/4"	2CVVDP	\$16.63
3/8"	3CVVDP	6.76
1/2"	4CVVDP	7.80
3/4"	6CVVDP	8.08
1"	8CVVDP	8.15
1 1/4"	10CVVDP	15.42

CVV-Series European Interchange Dust Caps



Body Size	Plastic	
	Part #	Price/E
1/4"	CVV2DC	\$16.63
3/8"	CVV3DC	5.63
1/2"	CVV4DC	6.06
3/4"	CVV6DC	6.80
1"	CVV8DC	6.93
1 1/4"	CVV10DC	10.66

Male Flat Face Unions

Features:

- reference SAE 520101
- pressure rating at **70°F (21°C)**

Male Flat Face	PSI	Zinc Plated Steel	
		Part #	Price/E
9/16"-18	6000	FS2403-4	\$1.95
11/16"-16	6000	FS2403-6	2.90
13/16"-16	6000	FS2403-8	3.75
1"-14	6000	FS2403-10	5.00
1-3/16"-12	6000	FS2403-12	6.70
1-7/16"-12	6000	FS2403-16	9.55



Male Flat Face x Male SAE O-ring Boss Connectors

Features:

- reference SAE 520120
- pressure rating at **70°F (21°C)**

Male Flat Face	Male SAE O-ring Boss	PSI	Zinc Plated Steel	
			Part #	Price/E
9/16"-18	7/16"-20	5000	FS6400-4-4	\$2.00
11/16"-16	9/16"-18	5000	FS6400-6-6	2.40
13/16"-16	3/4"-16	4500	FS6400-8-8	3.00
1"-14	7/8"-14	3500	FS6400-10-10	3.85
1-3/16"-12	1-1/16"-12	3500	FS6400-12-12	5.45
1-7/16"-12	1-5/16"-12	3000	FS6400-16-16	7.90



Male Flat Face x Male NPTF Connectors

Features:

- reference SAE 520102
- pressure rating at **70°F (21°C)**

Male Flat Face	Male NPTF	PSI	Zinc Plated Steel	
			Part #	Price/E
9/16"-18	1/4"-18	5000	FS2404-4-4	\$2.05
11/16"-16	3/8"-18	4000	FS2404-6-6	2.15
13/16"-16	1/2"-14	3000	FS2404-8-8	3.15
1-3/16"-12	3/4"-14	2500	FS2404-12-12	8.25
1-7/16"-12	1"-11 1/2	2000	FS2404-16-16	8.90



Male x Female Flat Face Swivel Nut 90° Elbows

Features:

- reference SAE 520221
- pressure rating at **70°F (21°C)**

Male Flat Face	Female Flat Face	PSI	Zinc Plated Steel	
			Part #	Price/E
9/16"-18	9/16"-18	6000	FS6500-4-4	\$7.45
11/16"-16	11/16"-16	6000	FS6500-6-6	9.30
13/16"-16	13/16"-16	6000	FS6500-8-8	11.55
1"-14	1"-14	6000	FS6500-10-10	14.30
1-3/16"-12	1-3/16"-12	6000	FS6500-12-12	15.40
1-7/16"-12	1-7/16"-12	6000	FS6500-16-16	33.70



Male Flat Face x Male SAE O-ring Boss 90° Elbows

Features:

- reference SAE 520220
- pressure rating at **70°F (21°C)**

Male Flat Face	Male SAE O-ring Boss	PSI	Zinc Plated Steel	
			Part #	Price/E
9/16"-18	7/16"-20	5000	FS6801-4-4	\$4.35
11/16"-16	9/16"-18	5000	FS6801-6-6	5.60
13/16"-16	3/4"-16	4500	FS6801-8-8	6.40
1"-14	7/8"-14	3500	FS6801-10-10	10.15
1-3/16"-12	1-1/16"-12	3500	FS6801-12-12	13.55
1-7/16"-12	1-5/16"-12	3000	FS6801-16-16	19.70





Male Flat Face x Male NPTF 90° Elbows

Features:

- reference SAE 520202
- pressure rating at **70°F (21°C)**

Male Flat Face	Male NPTF	PSI	Zinc Plated Steel	
			Part #	Price/E
9/16"-18	1/4"-18	5000	FS2501-4-4	\$3.35
11/16"-16	3/8"-18	4000	FS2501-6-6	4.65
13/16"-16	1/2"-14	3000	FS2501-8-8	6.30
1-3/16"-12	3/4"-14	2500	FS2501-12-12	10.10
1-7/16"-12	1"-11 1/2	2000	FS2501-16-16	16.85

Male Flat Face Union Tees

Features:

- reference SAE 520401
- pressure rating at **70°F (21°C)**



Male Flat Face	Male Flat Face	Male Flat Face	PSI	Zinc Plated Steel	
				Part #	Price/E
9/16"-18	9/16"-18	9/16"-18	6000	FS2603-4	\$5.85
11/16"-16	11/16"-16	11/16"-16	6000	FS2603-6	7.85
13/16"-16	13/16"-16	13/16"-16	6000	FS2603-8	8.05
1-3/16"-12	1"-14	1"-14	6000	FS2603-10	13.20
1-7/16"-12	1-3/16"-12	1-3/16"-12	6000	FS2603-12	17.00
1-7/16"-12	1-7/16"-12	1-7/16"-12	6000	FS2603-16	26.60

Male x Female Swivel x Male Flat Face Run Tees

Features:

- reference SAE 520432
- pressure rating at **70°F (21°C)**



Male Flat Face	Female Flat Face Swivel	Male Flat Face	PSI	Zinc Plated Steel	
				Part #	Price/E
9/16"-18	9/16"-18	9/16"-18	4500	FS6602-4	\$7.85
11/16"-16	11/16"-16	11/16"-16	4000	FS6602-6	10.35
13/16"-16	13/16"-16	13/16"-16	4000	FS6602-8	11.20
1"-14	1"-14	1"-14	3000	FS6602-10	18.05
1-3/16"-12	1-3/16"-12	1-3/16"-12	3000	FS6602-12	23.35
1-7/16"-12	1-7/16"-12	1-7/16"-12	2500	FS6602-16	34.55

Flat Face Caps

Features:

- reference SAE 520112
- pressure rating at **70°F (21°C)**



Female Flat Face	PSI	Zinc Plated Steel	
		Part #	Price/E
9/16"-18	6000	FS304C-4	\$1.95
11/16"-16	6000	FS304C-6	2.40
13/16"-16	6000	FS304C-8	2.65
1"-14	6000	FS304C-10	3.65
1-3/16"-12	6000	FS304C-12	5.25
1-7/16"-12	6000	FS304C-16	7.20

Flat Face Plugs

Features:

- reference SAE 520109
- pressure rating at **70°F (21°C)**



Male Flat Face	PSI	Zinc Plated Steel	
		Part #	Price/E
9/16"-18	6000	FS2408-4	\$1.65
11/16"-16	6000	FS2408-6	1.75
13/16"-16	6000	FS2408-8	2.20
1"-14	6000	FS2408-10	3.05
1-3/16"-12	6000	FS2408-12	4.50
1-7/16"-12	6000	FS2408-16	6.95

Feature:

- pressure rating at **70°F (21°C)**

O-ring Boss Port Reducers

Male SAE O-ring Boss	Female O-ring Port	PSI	Zinc Plated Steel	
			Part #	Price/E
9/16"-18	7/16"-20	5000	6410-6-4	\$2.50
9/16"-18	¾"-16	4500	6410-6-8	4.25
¾"-16	⅞"-14	3500	6410-8-10	4.30
¾"-16	9/16"-18	4500	6410-8-6	3.00
⅞"-14	1-1/16"-12	3500	6410-10-12	7.30
⅞"-14	¾"-16	3500	6410-10-8	4.15
1-1/16"-12	⅞"-14	3000	6410-12-10	6.25
1-1/16"-12	1-5/16"-12	3000	6410-12-16	13.80

**Feature:**

- pressure rating at **70°F (21°C)**

Adjustable O-ring Unions

Male O-ring Boss	Adjustable O-ring Boss	PSI	Zinc Plated Steel	
			Part #	Price/E
7/16"-20	7/16"-20	4500	6403-4	\$2.80
9/16"-18	9/16"-18	4000	6403-6	3.85
¾"-16	¾"-16	4000	6403-8	4.90
⅞"-14	⅞"-14	3000	6403-10	5.80
1-1/16"-12	1-1/16"-12	3000	6403-12	10.60
1-5/16"-12	1-5/16"-12	2500	6403-16	11.80



Male JIC x Male SAE O-ring Boss

Features:

- reference SAE 070120
- pressure rating at **70°F (21°C)**

Male JIC	Male SAE O-ring Boss	PSI	Zinc Plated Steel	
			Part #	Price/E
7/16"-20	7/16"-20	5000	1231-04-04	\$1.35
7/16"-20	9/16"-18	5000	1231-04-06	1.55
7/16"-20	¾"-16	4500	1231-04-08	2.45
½"-20	½"-20	5000	1231-05-05	2.20
9/16"-18	7/16"-20	5000	1231-06-04	1.60
9/16"-18	9/16"-18	5000	1231-06-06	1.65
9/16"-18	¾"-16	4500	1231-06-08	2.05
9/16"-18	⅞"-14	3500	1231-06-10	3.00
¾"-16	9/16"-18	4500	1231-08-06	2.50
¾"-16	¾"-16	4500	1231-08-08	2.25
¾"-16	⅞"-14	3500	1231-08-10	2.85
¾"-16	1-1/16"-12	3500	1231-08-12	4.10
⅞"-14	⅞"-16	3500	1231-10-08	3.25
⅞"-14	⅞"-14	3500	1231-10-10	3.00
⅞"-14	1-1/16"-12	3500	1231-10-12	4.10
1-1/16"-12	⅞"-14	3500	1231-12-10	4.30
1-1/16"-12	1-1/16"-12	3500	1231-12-12	4.50
1-1/16"-12	1-5/16"-12	3000	1231-12-16	6.75
1-5/16"-12	1-1/16"-12	3000	1231-16-12	5.45
1-5/16"-12	1-5/16"-12	3000	1231-16-16	6.45
1-5/16"-12	1⅝"-12	2500	1231-16-20	11.35
1⅝"-12	1-5/16"-12	2500	1231-20-16	13.30
1⅝"-12	1⅝"-12	2500	1231-20-20	13.25

**Feature:**

- pressure rating at **70°F (21°C)**

Male O-Ring Boss x Male NPTF

Male SAE O-ring Boss	Male NPTF Pipe Adapter	PSI	Zinc Plated Steel	
			Part #	Price/E
7/16"-20	¼"-18	5000	6401-4-4	\$1.95
9/16"-18	¼"-18	4000	6401-6-4	2.00
9/16"-18	⅜"-18	4000	6401-6-6	2.45
9/16"-18	½"-14	3000	6401-6-8	4.50
¾"-16	⅜"-18	3000	6401-8-6	3.00
¾"-16	½"-14	3000	6401-8-8	2.95
⅞"-14	½"-14	3000	6401-10-8	3.45
1-1/16"-12	¾"-14	2500	6401-12-12	5.80
1-5/16"-12	1"-11½	2000	6401-16-16	9.80



Male O-ring Boss x Female NPTF

Feature:

- pressure rating at 70°F (21°C)



Male SAE O-ring Boss	Female NPTF Pipe	PSI	Zinc Plated Steel	
			Part #	Price/E
7/16"-20	1/8"-27	5000	6405-4-2	\$2.30
7/16"-20	1/4"-18	5000	6405-4-4	2.95
7/16"-20	3/8"-18	4000	6405-4-6	2.70
9/16"-18	1/4"-18	4000	6405-6-4	2.35
9/16"-18	3/8"-18	4000	6405-6-6	3.20
9/16"-18	1/2"-14	3000	6405-6-8	5.90
3/4"-16	3/8"-18	4000	6405-8-6	3.25
3/4"-16	1/2"-14	3000	6405-8-8	4.20
7/8"-14	1/4"-18	3000	6405-10-4	4.50
7/8"-14	1/2"-14	3000	6405-10-8	4.15
7/8"-14	3/4"-14	2500	6405-10-12	7.70
1-1/16"-12	1/2"-14	3000	6405-12-8	6.40
1-1/16"-12	3/4"-14	2500	6405-12-12	6.65
1-1/16"-12	1"-11 1/2	2000	6405-12-16	7.45
1-5/16"-12	3/4"-14	2500	6405-16-12	7.25
1-5/16"-12	1"-11 1/2	2000	6405-16-16	9.10
1-5/16"-12	1 1/4"-11 1/2	1150	6405-16-20	19.10
1 5/8"-12	1"-11 1/2	2000	6405-20-16	16.00
1 5/8"-12	1 1/4"-11 1/2	1150	6405-20-20	17.25

90° Male SAE O-ring Boss x Male JIC Elbows

Features:

- reference SAE 070220
- pressure rating at 70°F (21°C)



Male SAE O-ring Boss	Male JIC	PSI	Zinc Plated Steel	
			Part #	Price/E
7/16"-20	7/16"-20	5000	1238-04-04	\$3.40
7/16"-20	9/16"-18	5000	1238-04-06	4.00
9/16"-18	7/16"-20	5000	1238-06-04	3.90
9/16"-18	9/16"-18	5000	1238-06-06	3.45
3/4"-16	9/16"-18	4500	1238-08-06	5.90
3/4"-16	3/4"-16	4500	1238-08-08	5.10
3/4"-16	7/8"-14	3500	1238-08-10	7.75
7/8"-14	3/4"-16	3500	1238-10-08	7.45
7/8"-14	7/8"-14	3500	1238-10-10	8.00
7/8"-14	1-1/16"-12	3500	1238-10-12	9.70
1-1/16"-12	7/8"-14	3500	1238-12-10	10.35
1-1/16"-12	1-1/16"-12	3500	1238-12-12	10.10
1-1/16"-12	1-5/16"-12	3000	1238-12-16	15.35
1-5/16"-16	1-1/16"-12	3000	1238-16-12	17.60
1-5/16"-12	1-5/16"-12	3000	1238-16-16	15.35
1 5/8"-12	1-5/16"-12	2500	1238-20-16	31.15
1 5/8"-12	1 5/8"-12	2500	1238-20-20	27.05
1 7/8"-12	1 7/8"-12	2000	1238-24-24	43.00

90° SAE O-ring Boss x Female NPSM Swivel Nut Elbows

Features:

- reference SAE 140257
- pressure rating at 70°F (21°C)



Male SAE O-ring Boss	Female NPSM Swivel	PSI	Zinc Plated Steel	
			Part #	Price/E
7/16"-20	1/4"-18	4500	6901-4-4	\$5.20
7/16"-20	3/8"-18	4000	6901-4-6	7.80
9/16"-18	1/4"-18	4000	6901-6-4	6.10
9/16"-18	3/8"-18	4000	6901-6-6	6.35
9/16"-18	1/2"-14	4000	6901-6-8	9.55
3/4"-16	3/8"-18	3500	6901-8-6	7.80
3/4"-16	1/2"-14	4000	6901-8-8	8.30
3/4"-16	3/4"-14	3000	6901-8-12	14.45
7/8"-14	1/2"-14	3500	6901-10-8	10.00
7/8"-14	3/4"-14	3000	6901-10-12	17.35
1-1/16"-12	1/2"-14	3500	6901-12-8	15.30
1-1/16"-12	3/4"-14	3000	6901-12-12	14.60
1-1/16"-12	1"-11 1/2	2500	6901-12-16	20.45
1-5/16"-12	3/4"-14	3000	6901-16-12	22.70
1-5/16"-12	1"-11 1/2	2500	6901-16-16	20.80
1-5/16"-12	1 1/4"-11 1/2	2000	6901-16-20	42.00
1 5/8"-12	1 1/4"-11 1/2	2000	6901-20-20	39.90

45° Male SAE O-ring Boss x Male JIC Elbows

Features:

- reference SAE 070320
- pressure rating at 70°F (21°C)

Male SAE O-ring Boss	Male JIC	PSI	Zinc Plated Steel	
			Part #	Price/E
7/16"-20	7/16"-20	5000	1240-04-04	\$3.75
9/16"-18	9/16"-18	5000	1240-06-06	4.20
9/16"-18	3/4"-16	4500	1240-06-08	6.25
3/4"-16	9/16"-18	4500	1240-08-06	7.10
3/4"-16	3/4"-16	4500	1240-08-08	6.20
3/4"-16	7/8"-14	3500	1240-08-10	9.00
7/8"-14	3/4"-16	3500	1240-10-08	7.45
7/8"-14	7/8"-14	3500	1240-10-10	7.95
7/8"-14	1-1/16"-12	3500	1240-10-12	11.40
1-1/16"-12	7/8"-14	3500	1240-12-10	10.45
1-1/16"-12	1-1/16"-12	3500	1240-12-12	10.65
1-1/16"-12	1-5/16"-12	3000	1240-12-16	16.45
1-5/16"-12	1-5/16"-12	3000	1240-16-16	15.25
1 5/8"-12	1-5/16"-12	2500	1240-20-16	35.00
1 5/8"-12	1 5/8"-12	2500	1240-20-20	34.85



Hydraulic Fittings

Male 37° Flare x Male O-ring Boss Branch Tees

Features:

- reference SAE 070429
- pressure rating at 70°F (21°C)

(2) Male JIC 37°	Male SAE O-ring Boss	PSI	Zinc Plated Steel	
			Part #	Price/E
7/16"-20	7/16"-20	5000	6803-4	\$5.40
9/16"-18	9/16"-18	5000	6803-6	5.80
3/4"-16	3/4"-16	4500	6803-8	8.10
7/8"-14	7/8"-14	3500	6803-10	11.90
1-1/16"-12	1-1/16"-12	3500	6803-12	17.35
1-5/16"-12	1-5/16"-12	3000	6803-16	23.15



SAE O-ring Boss Plugs

Features:

- reference SAE 090109A
- pressure rating at 70°F (21°C)

Male SAE O-ring Boss	PSI	Zinc Plated Steel	
		Part #	Price/E
7/16"-20	5000	1255-04H	\$1.00
9/16"-18	5000	1255-06H	1.10
3/4"-16	4500	1255-08H	1.65
7/8"-14	3500	1255-10H	2.05
1-1/16"-12	3500	1255-12H	2.90
1-5/16"-12	3000	1255-16H	4.15
1 5/8"-12	2500	1255-20H	7.05
1 7/8"-12	2000	1255-24H	12.60
2 1/2"-12	1500	1255-32H	32.60



Hollow Hex O-ring Plugs

Features:

- reference SAE 090109B
- requires Allen wrench
- pressure rating at 70°F (21°C)

Male SAE O-ring Boss	PSI	Zinc Plated Steel	
		Part #	Price/E
7/16"-20	5000	6408HHP-4	\$0.85
9/16"-18	5000	6408HHP-6	1.10
3/4"-16	4500	6408HHP-8	1.80
7/8"-14	3500	6408HHP-10	1.95
1-1/16"-12	3500	6408HHP-12	2.60
1-5/16"-12	3000	6408HHP-16	3.90
1 5/8"-12	2500	6408HHP-20	8.15
1 7/8"-12	1500	6408HHP-24	11.95
2 1/2"-12	1500	6408HHP-32	20.65





Male JIC 37° x Male 37° JIC

Features:

- reference SAE 070101
- pressure rating at 70°F (21°C)

Male JIC 37°	Male JIC 37°	PSI	Zinc Plated Steel	
			Part #	Price/E
7/16"-20	7/16"-20	5000	1204-04-04	\$1.20
9/16"-18	9/16"-18	5000	1204-06-06	1.60
3/4"-16	7/16"-20	4500	1204-08-04	3.15
3/4"-16	3/4"-16	4500	1204-08-08	2.35
7/8"-14	3/4"-16	3500	1204-10-08	3.80
7/8"-14	7/8"-14	3500	1204-10-10	4.05
1-1/16"-12	3/4"-16	3500	1204-12-08	5.05
1-1/16"-12	7/8"-14	3500	1204-12-10	4.95
1-1/16"-12	1-1/16"-12	3500	1204-12-12	4.15
1-5/16"-12	1-1/16"-12	3000	1204-16-12	9.05
1-5/16"-12	1-5/16"-12	3000	1204-16-16	7.55
1 5/8"-12	1 5/8"-12	2500	1204-20-20	11.65
1 7/8"-12	1 7/8"-12	2000	1204-24-24	21.30

Male JIC 37° Flare x Male NPTF

Features:

- reference SAE 070102
- pressure rating at 70°F (21°C)

Male JIC 37° Flare	Male NPTF	PSI	Zinc Plated Steel		316 Stainless Steel	
			Part #	Price/E	Part #	Price/E
7/16"-20	1/8"-27	4500	2404-4-2	\$1.20	---	---
7/16"-20	1/4"-18	4500	2404-4-4	1.55	SS2404-4-4	\$15.10
7/16"-20	3/8"-18	4000	2404-4-6	2.05	---	---
7/16"-20	1/2"-18	3000	2404-4-8	4.95	---	---
1/2"-20	1/8"-27	4000	2404-5-2	2.25	---	---
9/16"-18	1/8"-27	4000	2404-6-2	1.75	---	---
9/16"-18	1/4"-18	4000	2404-6-4	1.55	---	---
9/16"-18	3/8"-18	4000	2404-6-6	2.10	SS2404-6-6	22.00
9/16"-18	1/2"-14	3000	2404-6-8	2.45	---	---
3/4"-16	1/4"-18	4000	2404-8-4	2.25	---	---
3/4"-16	3/8"-18	4000	2404-8-6	2.25	---	---
3/4"-16	1/2"-14	3000	2404-8-8	2.55	SS2404-8-8	23.50
3/4"-16	3/4"-14	2500	2404-8-12	4.20	---	---
7/8"-14	1/2"-14	3000	2404-10-8	2.75	---	---
7/8"-14	3/4"-14	2500	2404-10-12	4.05	---	---
1-1/16"-12	1/2"-14	3000	2404-12-8	5.35	---	---
1-1/16"-12	3/4"-14	2500	2404-12-12	4.20	SS2404-12-12	52.00
1-1/16"-12	1"-11 1/2	2000	2404-12-16	6.15	---	---
1-5/16"-12	3/4"-14	2500	2404-16-12	8.80	---	---
1-5/16"-12	1"-11 1/2	2000	2404-16-16	6.25	SS2404-16-16	65.00
1 5/8"-12	1 1/4"-11 1/2	1150	2404-20-20	9.55	---	---
1 7/8"-12	1 1/2"-11 1/2	1000	2404-24-24	16.60	---	---
2 1/2"-12	2"-11 1/2	1000	2404-32-32	42.00	---	---

Male JIC 37° Flare x Female NPTF

Features:

- reference SAE 070103
- pressure rating at 70°F (21°C)

Male JIC 37° Flare	Female NPTF	PSI	Zinc Plated Steel		316 Stainless Steel	
			Part #	Price/E	Part #	Price/E
7/16"-20	1/8"-27	4500	2405-4-2	\$2.40	---	---
7/16"-20	1/4"-18	4500	2405-4-4	2.95	SS2405-4-4	\$19.90
9/16"-18	1/4"-18	4000	2405-6-4	3.05	---	---
9/16"-18	3/8"-18	4000	2405-6-6	3.00	SS2405-6-6	25.50
9/16"-18	1/2"-14	3000	2405-6-8	4.50	---	---
3/4"-16	3/8"-18	4000	2405-8-6	3.80	---	---
3/4"-16	1/2"-14	3000	2405-8-8	4.20	SS2405-8-8	41.00
3/4"-16	3/4"-14	2500	2405-8-12	13.35	---	---
7/8"-14	1/2"-14	3000	2405-10-8	5.95	---	---
1-1/16"-12	3/4"-14	2500	2405-12-12	6.65	SS2405-12-12	67.00
1-1/16"-12	1"-11 1/2	2000	2405-12-16	20.80	---	---
1-5/16"-12	1"-11 1/2	2000	2405-16-16	9.15	SS2405-16-16	112.00
1 5/8"-12	1 1/4"-11 1/2	1150	2405-20-20	19.30	---	---



Female JIC 37° Swivel x Male NPTF

Feature:

- pressure rating at **70°F (21°C)**

Female JIC 37° Swivel	Male NPTF Pipe	PSI	Zinc Plated Steel	
			Part #	Price/E
7/16"-20	1/8"-27	4500	6505-4-2	\$4.90
7/16"-20	1/4"-18	4500	6505-4-4	3.30
1/2"-20	1/4"-18	4000	6505-5-4	5.05
9/16"-18	1/4"-18	4000	6505-6-4	4.45
9/16"-18	3/8"-18	4000	6505-6-6	4.25
3/4"-16	3/8"-18	4000	6505-8-6	5.35
7/8"-14	1/2"-14	3000	6505-10-8	6.80
7/8"-14	3/4"-14	2500	6505-10-12	10.75
1-1/16"-12	1/2"-14	3000	6505-12-8	9.90
1-1/16"-12	3/4"-14	2500	6505-12-12	7.95
1-5/16"-12	3/4"-14	2500	6505-16-12	15.20
1-5/16"-12	1"-1/2	2000	6505-16-16	14.30
1 5/8"-12	1 1/4"-11 1/2	1150	6505-20-20	19.75
1 7/8"-12	1 1/2"-11 1/2	1000	6505-24-24	32.00
2 1/2"-12	2"-11 1/2	1000	6505-32-32	51.00



Female JIC 37° Swivel x Female NPTF

Feature:

- pressure rating at **70°F (21°C)**

Female JIC 37° Swivel	Female NPTF	PSI	Zinc Plated Steel	
			Part #	Price/E
7/16"-20	1/4"-18	4500	6506-4-4	\$4.90
7/16"-20	3/8"-18	4000	6506-4-6	6.65
9/16"-18	1/4"-18	4000	6506-6-4	6.35
9/16"-18	3/8"-18	4000	6506-6-6	6.45
3/4"-16	1/2"-14	3000	6506-8-8	6.95
7/8"-14	1/2"-14	3000	6506-10-8	10.50
1-1/16"-12	3/4"-14	2500	6506-12-12	10.85
1-5/16"-12	1" 11/2	2000	6506-16-16	15.25



90° Male JIC 37° Flare Elbows

Features:

- reference SAE 070201
- pressure rating at **70°F (21°C)**

Male JIC 37° Flare	Male JIC 37° Flare	PSI	Zinc Plated Steel	
			Part #	Price/E
7/16"-20	7/16"-20	5000	1234-04-04	\$2.45
9/16"-18	9/16"-18	5000	1234-06-06	3.30
3/4"-16	3/4"-16	4500	1234-08-08	4.45
7/8"-14	7/8"-14	3500	1234-10-10	6.20
1-1/16"-12	1-1/16"-12	3500	1234-12-12	8.60
1-5/16"-12	1-5/16"-12	3000	1234-16-16	13.05
1 5/8"-12	1 5/8"-12	2500	1234-20-20	25.40



90° Male 37° JIC Flare x Female JIC 37° Flare Swivel Elbows

Features:

- reference SAE 070221
- pressure rating at **70°F (21°C)**

Male 37° JIC Flare	Female 37° JIC Swivel	PSI	Zinc Plated Steel	
			Part #	Price/E
7/16"-20	7/16"-20	5000	6500-4	\$3.25
9/16"-18	9/16"-18	5000	6500-6	3.65
9/16"-18	7/16"-20	5000	6500-6-4	5.40
9/16"-18	3/4"-16	4500	6500-6-8	5.90
3/4"-16	3/4"-16	4500	6500-8	5.55
3/4"-16	9/16"-18	4500	6500-8-6	6.10
3/4"-16	7/8"-14	3500	6500-8-10	9.10
7/8"-14	7/8"-14	3500	6500-10	7.30
1-1/16"-12	1-1/16"-12	3500	6500-12	9.75
1-1/16"-12	7/8"-14	3500	6500-12-10	11.65
1-5/16"-12	1-5/16"-12	3000	6500-16	17.25
1 5/8"-12	1 5/8"-12	2500	6500-20	35.55



90° Male JIC 37° Flare x Male NPTF Elbows

Features:

- reference SAE 070202
- pressure rating at 70°F (21°C)



Male JIC 37° Flare	Male NPTF	PSI	Zinc Plated Steel		316 Stainless Steel	
			Part #	Price/E	Part #	Price/E
7/16"-20	1/8"-27	4500	2501-4-2	\$3.15	---	---
7/16"-20	1/4"-18	4500	2501-4-4	3.05	SS2501-4-4	\$18.90
7/16"-20	3/8"-18	4000	2501-4-6	4.10	---	---
7/16"-20	1/2"-20	4000	2501-6-2	3.75	---	---
1/2"-20	1/4"-18	4000	2501-6-4	2.80	SS2501-6-6	31.00
9/16"-18	3/8"-18	4000	2501-6-6	3.90	---	---
9/16"-18	1/2"-14	3000	2501-6-8	4.80	---	---
9/16"-18	3/4"-18	4000	2501-8-4	5.70	---	---
9/16"-18	1/2"-14	3000	2501-8-6	4.90	SS2501-8-8	47.00
3/4"-16	1/2"-14	3000	2501-8-8	5.25	---	---
3/4"-16	3/4"-14	2500	2501-8-12	7.80	---	---
3/4"-16	1/2"-14	3000	2501-10-8	6.25	---	---
3/4"-16	3/4"-14	2500	2501-10-12	8.10	---	---
7/8"-14	1/2"-14	3000	2501-12-8	8.10	SS2501-12-12	76.00
7/8"-14	3/4"-14	2500	2501-12-12	8.65	---	---
1-1/16"-12	1"-11 1/2	2000	2501-12-16	11.95	---	---
1-1/16"-12	3/4"-14	2500	2501-16-12	12.40	SS2501-16-16	110.00
1-1/16"-12	1"-11 1/2	2000	2501-16-16	12.00	---	---
1-5/16"-12	1"-11 1/2	2000	2501-20-16	28.00	---	---
1-5/16"-12	1 1/4"-11 1/2	1150	2501-20-20	23.80	---	---
1 5/8"-12	1 1/2"-11 1/2	1000	2501-24-24	41.00	---	---
1 7/8"-12	2"-11 1/2	1000	2501-32-32	87.10	---	---

90° Female JIC 37° Swivel x Male NPTF Elbows

Feature:

- pressure rating at 70°F (21°C)



Female JIC 37° Swivel	Male NPTF	PSI	Zinc Plated Steel	
			Part #	Price/E
7/16"-20	1/8"-27	4500	6501-4-2	\$3.60
7/16"-20	1/4"-18	4500	6501-4-4	3.90
1/2"-20	1/8"-27	4000	6501-5-2	4.10
9/16"-18	1/4"-18	4000	6501-6-4	4.30
9/16"-18	3/8"-18	4000	6501-6-6	5.45
3/4"-16	3/8"-18	4000	6501-8-6	5.65
3/4"-16	1/2"-14	3000	6501-8-8	7.90
7/8"-14	1/2"-14	3000	6501-10-8	10.40
1-1/16"-12	3/4"-14	2500	6501-12-12	11.30
1-3/16"-12	3/4"-14	2500	6501-14-12	17.00
1-5/16"-12	1"-11 1/2	2000	6501-16-16	18.90
1 5/8"-12	1 1/4"-11 1/2	1150	6501-20-20	32.50
1 7/8"-12	1 1/2"-11 1/2	1000	6501-24-24	47.00
2 1/2"-12	2"-11 1/2	1000	6501-32-32	94.00

45° Male JIC 37° Flare x Female JIC 37° Swivel Elbows

Features:

- reference SAE 070321
- pressure rating at 70°F (21°C)



Male JIC 37°	Female JIC 37° Swivel	PSI	Zinc Plated Steel	
			Part #	Price/E
7/16"-20	7/16"-20	4500	6502-4	\$3.90
9/16"-18	9/16"-18	4000	6502-6	4.30
3/4"-16	3/4"-16	4000	6502-8	4.90
7/8"-14	7/8"-14	3000	6502-10	9.15
1 1/16"-12	1 1/16"-12	3000	6502-12	10.40
1 5/16"-12	1 5/16"-12	2500	6502-16	16.95
1 5/8"-12	1 5/8"-12	2000	6502-20	35.00

Features:

45° Male JIC 37° Flare x Male NPTF Elbows

- reference SAE 070302
- pressure rating at **70°F (21°C)**

Male JIC 37° Flare	Male NPTF	PSI	Zinc Plated Steel	
			Part #	Price/E
7/16"-20	1/8"-27	4500	2503-4-2	\$2.90
7/16"-20	1/4"-18	4500	2503-4-4	3.15
9/16"-18	1/4"-18	4000	2503-6-4	3.40
9/16"-18	3/8"-18	4000	2503-6-6	3.90
3/4"-16	1/4"-18	4000	2503-8-4	4.75
3/4"-16	3/8"-18	4000	2503-8-6	4.70
3/4"-16	1/2"-14	3000	2503-8-8	5.00
7/8"-14	1/2"-14	3000	2503-10-8	6.55
7/8"-14	3/4"-14	2500	2503-10-12	7.65
1-1/16"-12	3/4"-14	2500	2503-12-12	8.00
1-5/16"-12	3/4"-14	2500	2503-16-12	13.30
1-5/16"-12	1"-11 1/2	2000	2503-16-16	14.10



Male JIC 37° Flare Union Tees

Features:

- reference SAE 070401
- pressure rating at **70°F (21°C)**

Male JIC 37° Flare (3)	PSI	Zinc Plated Steel	
		Part #	Price/E
7/16"-20	5000	2603-4	\$4.75
9/16"-18	5000	2603-6	4.35
3/4"-16	4500	2603-8	7.10
7/8"-14	3500	2603-10	9.75
1-1/16"-12	3500	2603-12	13.35
1-5/16"-12	3000	2603-16	19.10



Male 37° Flare x Female 37° Swivel Tees

Features:

- reference SAE 070433
- pressure rating at **70°F (21°C)**

Male JIC 37° Flare (2)	Female JIC 37° Swivel	PSI	Zinc Plated Steel	
			Part #	Price/E
7/16"-20	7/16"-20	4500	6600-4	\$5.70
9/16"-18	9/16"-18	4000	6600-6	5.90
3/4"-16	3/4"-16	4000	6600-8	7.85
1 1/16"-12	1 1/16"-12	3000	6600-12	15.85
1 5/16"-12	1 5/16"-12	2500	6600-16	25.85



Male JIC 37° Flare x Female 37° Swivel Run Tees

Features:

- reference SAE 070432
- pressure rating at **70°F (21°C)**

Male JIC 37° Flare (2)	Female JIC 37° Swivel	PSI	Zinc Plated Steel	
			Part #	Price/E
7/16"-20	7/16"-20	4500	6602-4	\$5.95
9/16"-18	9/16"-18	4000	6602-6	6.45
3/4"-16	3/4"-16	4000	6602-8	8.75
7/8"-14	7/8"-14	3000	6602-10	12.80
1-1/16"-12	1-1/16"-12	3000	6602-12	15.30
1-5/16"-12	1-5/16"-12	2500	6602-16	26.15
1 5/8"-12	1 5/8"-12	2000	6602-20	54.65



Male JIC 37° Flare x Male NPTF Branch Tees

Features:

- reference SAE070425
- pressure rating at **70°F (21°C)**

Male JIC 37° Flare (2)	Male NPTF	PSI	Zinc Plated Steel	
			Part #	Price/E
7/16"-20	1/4"-18	5000	2601-4-4-4	\$5.40
9/16"-18	1/4"-18	5000	2601-6-6-4	4.75
9/16"-18	3/8"-18	4000	2601-6-6-6	7.10
3/4"-16	1/2"-14	3000	2601-8-8-8	8.55
7/8"-14	1/2"-14	3000	2601-10-10-8	9.70
1-1/16"-12	3/4"-14	2500	2601-12-12-12	13.40
1-5/16"-12	1"-11 1/2	2000	2601-16-16-16	21.45



JIC 37° Flare Caps

Features:

- reference SAE 070112
- pressure rating at 70°F (21°C)

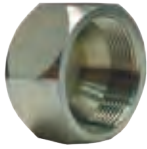

Female JIC 37° Flare	Tube OD	PSI	Zinc Plated Steel	
			Part #	Price/E
5/16"-24	1/8"	5000	0304C-2	\$1.55
7/16"-20	1/4"	5000	0304C-4	0.85
9/16"-18	3/8"	5000	0304C-6	0.95
3/4"-16	1/2"	4500	0304C-8	1.35
7/8"-14	5/8"	3500	0304C-10	1.65
1-1/16"-12	3/4"	3500	0304C-12	2.45
1-5/16"-12	1"	3000	0304C-16	3.55
1 5/8"-12	1 1/4"	2500	0304C-20	7.10
1 7/8"-12	1 1/2"	2000	0304C-24	15.85
2 1/2"-12	2"	1500	0304C-32	24.10

JIC 37° Flare Tube Nuts

Features:

- reference SAE 070110
- pressure rating at 70°F (21°C)

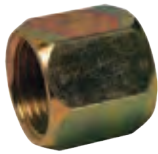

Female JIC 37° Flare	Tube OD	PSI	Zinc Plated Steel	
			Part #	Price/E
7/16"-20	1/4"	5000	0318-4	\$0.85
9/16"-18	3/8"	5000	0318-6	1.05
3/4"-16	1/2"	4500	0318-8	1.55
7/8"-14	5/8"	3500	0318-10	1.90
1-1/16"-12	3/4"	3500	0318-12	2.55
1-5/16"-12	1"	3000	0318-16	3.45

JIC Screw Thread Plugs

Features:

- reference SAE 070109
- pressure rating at 70°F (21°C)



Male JIC 37° Flare	PSI	Zinc Plated Steel	
		Part #	Price/E
5/16"-24	5000	1254-02H	\$1.55
7/16"-20	5000	1254-04H	1.15
9/16"-18	5000	1254-06H	1.20
3/4"-16	4500	1254-08H	1.40
7/8"-14	3500	1254-10H	2.75
1-1/16"-12	3500	1254-12H	2.85
1-5/16"-12	3000	1254-16H	4.00
1 5/8"-12	2500	1254-20H	6.80

JIC 37° Flare Tube Sleeves

Features:

- reference SAE 070115
- pressure rating at 70°F (21°C)



Female JIC 37° Flare	PSI	Zinc Plated Steel	
		Part #	Price/E
7/16"-20	5000	0319-4	\$0.55
9/16"-18	5000	0319-6	0.70
3/4"-16	4500	0319-8	0.80
7/8"-14	3500	0319-10	1.05
1-1/16"-12	3500	0319-12	1.35
1-5/16"-12	3000	0319-16	2.45

JIC 37° Flare Bulkhead Unions with Lock Nut

Features:

- reference SAE 070601
- pressure rating at 70°F (21°C)



Male JIC 37° Flare	PSI	Zinc Plated Steel	
		Part #	Price/E
7/16"-20	5000	2700LN-4	\$3.40
9/16"-18	5000	2700LN-6	3.70
3/4"-16	4500	2700LN-8	5.65
7/8"-14	3500	2700LN-10	7.45
1-1/16"-12	3500	2700LN-12	9.60
1-5/16"-12	3000	2700LN-16	13.65

JIC 37° Flare 90° Bulkhead Elbow with Lock Nuts

Features:

- reference SAE 070701
- pressure rating at **70°F (21°C)**

Male JIC 37° Flare	PSI	Zinc Plated Steel	
		Part #	Price/E
7/16"-20	5000	2701LN-4	\$4.50
9/16"-18	5000	2701LN-6	5.35
3/4"-16	4500	2701LN-8	8.80
7/8"-14	3500	2701LN-10	12.45
1-1/16"-12	3500	2701LN-12	13.85
1-5/16"-12	3000	2701LN-16	19.65



JIC 37° Flare Bulkhead Lock Nuts

Features:

- reference SAE 070118
- pressure rating at **70°F (21°C)**

Female JIC 37° Bulkhead	Tube OD	PSI	Zinc Plated Steel	
			Part #	Price/E
7/16"-20	1/4"	5000	0306-4	\$0.55
9/16"-18	3/8"	5000	0306-6	0.60
3/4"-16	1/2"	4500	0306-8	0.85
7/8"-14	5/8"	3500	0306-10	0.95
1-1/16"-12	3/4"	3500	0306-12	1.45
1-5/16"-12	1"	3000	0306-16	2.05



Straight Female Weld End Metal Hose Fittings

All fittings have 316 seamless stainless steel tubes

Feature:

- pressure rating at 70°F (21°C)

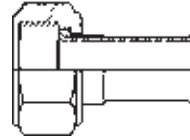

Female SAE 37° JIC	Tube OD	Pressure Rating PSI at 70°F	Dimension L	Tube Wall	304 Stainless Steel Nut & Sleeve		Carbon Steel Nut & Sleeve	
					Part #	Price/E	Part #	Price/E
7/16" - 20	1/4"	8650	1.500"	.049"	<i>SFMF250</i>	\$28.40	<i>FMF250</i>	\$17.30
9/16" - 18	3/8"	5550	1.500"	.049"	<i>SFMF375</i>	32.00	<i>FMF375</i>	21.20
3/4" - 16	1/2"	4050	1.500"	.049"	<i>SFMF500</i>	52.55	<i>FMF500</i>	28.65
1-1/16" - 12	3/4"	2600	1.500"	.049"	<i>SFMF750</i>	90.40	<i>FMF750</i>	42.10
1-5/16" - 12	1"	1950	2.000"	.049"	<i>SFMF1000</i>	141.30	<i>FMF1000</i>	63.45
1 5/8" - 12	1 1/4"	2050	2.375"	.065"	<i>SFMF1250</i>	240.15	<i>FMF1250</i>	126.05
1 7/8" - 12	1 1/2"	1700	2.375"	.065"	<i>SFMF1500</i>	407.30	<i>FMF1500</i>	174.95
2 1/2" - 12	2"	1250	2.500"	.065"	<i>SFMF2000</i>	790.55	<i>FMF2000</i>	325.05

45° Elbow Female Weld End Metal Hose Fittings

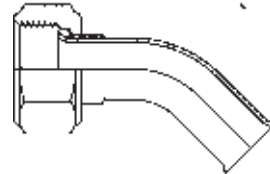

Female SAE 37° JIC	Tube OD	Pressure Rating PSI at 70°F	Dimension		Bend Radius	Tube Wall	304 Stainless Steel Nut & Sleeve		Carbon Steel Nut & Sleeve	
			A	B			Part #	Price/E	Part #	Price/E
7/16" - 20	1/4"	5000	0.750"	0.750"	0.380"	.049"	---	---	<i>FMF250-45</i>	\$28.70
9/16" - 18	3/8"	4500	1.000"	1.000"	0.500"	.049"	---	---	<i>FMF375-45</i>	38.25
3/4" - 16	1/2"	4000	1.250"	1.250"	1.000"	.049"	<i>SFMF500-45</i>	\$71.20	<i>FMF500-45</i>	69.20
1-1/16" - 12	3/4"	2600	1.450"	1.450"	1.500"	.049"	<i>SFMF750-45</i>	100.75	---	---
1-5/16" - 12	1"	2500	1.800"	1.800"	2.000"	.049"	<i>SFMF1000-45</i>	166.00	<i>FMF1000-45</i>	107.25
1 5/8" - 12	1 1/4"	2050	2.100"	2.100"	2.000"	.065"	<i>SFMF1250-45</i>	278.80	<i>FMF1250-45</i>	221.75
1 7/8" - 12	1 1/2"	1700	2.300"	2.300"	2.000"	.065"	<i>SFMF1500-45</i>	506.20	<i>FMF1500-45</i>	293.80
2 1/2" - 12	2"	1250	3.000"	3.000"	3.000"	.065"	<i>SFMF2000-45</i>	660.15	<i>FMF2000-45</i>	609.75

90° Elbow Female Weld End Metal Hose Fittings

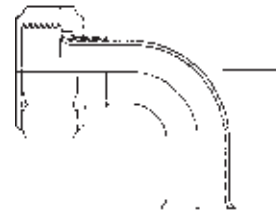

Female SAE 37° JIC	Tube OD	Pressure Rating PSI at 70°F	Dimension		Bend Radius	Tube Wall	304 Stainless Steel Nut & Sleeve		Carbon Steel Nut & Sleeve	
			A	B			Part #	Price/E	Part #	Price/E
7/16" - 20	1/4"	5000	1.000"	1.000"	0.375"	.049"	<i>SFMF250-90</i>	\$37.00	<i>FMF250-90</i>	\$33.70
9/16" - 18	3/8"	4500	1.250"	1.250"	0.500"	.049"	<i>SFMF375-90</i>	42.00	<i>FMF375-90</i>	40.60
3/4" - 16	1/2"	4000	1.830"	1.830"	1.000"	.049"	<i>SFMF500-90</i>	73.80	<i>FMF500-90</i>	58.95
1-1/16" - 12	3/4"	2600	2.350"	2.350"	1.500"	.049"	<i>SFMF750-90</i>	118.00	<i>FMF750-90</i>	95.40
1-5/16" - 12	1"	2500	3.100"	3.100"	2.000"	.049"	<i>SFMF1000-90</i>	173.05	<i>FMF1000-90</i>	127.95
1 5/8" - 12	1 1/4"	2050	3.500"	3.500"	2.000"	.065"	<i>SFMF1250-90</i>	308.85	<i>FMF1250-90</i>	205.25
1 7/8" - 12	1 1/2"	1700	3.750"	3.750"	2.000"	.065"	<i>SFMF1500-90</i>	432.20	<i>FMF1500-90</i>	261.10
2 1/2" - 12	2"	1250	4.900"	4.900"	2.000"	.065"	<i>SFMF2000-90</i>	866.80	<i>FMF2000-90</i>	631.10

Male NPTF Hex Pipe Nipples

Features:

- reference SAE 140137
- pressure rating at **70°F (21°C)**

Male NPTF	Male NPTF	PSI	Zinc Plated Steel	
			Part #	Price/E
1/8"-27	1/8"-27	5000	5404-2	\$1.15
1/4"-18	1/4"-18	5000	5404-4	1.35
3/8"-18	3/8"-18	4000	5404-6	2.00
3/8"-18	1/4"-18	4000	5404-6-4	1.90
1/2"-14	1/2"-14	3000	5404-8	2.60
1/2"-14	3/8"-18	3000	5404-8-6	2.50
3/4"-14	3/4"-14	2500	5404-12	4.05
3/4"-14	1/2"-14	2500	5404-12-8	3.80
1"-11½	1"-11½	2000	5404-16	6.35
1"-11½	3/4"-14	2000	5404-16-12	6.00
1¼"-11½	1¼"-11½	1150	5404-20	14.10



Male NPTF x Female NPTF Hex Reducer Bushings

Features:

- reference SAE 140140
- pressure rating at **70°F (21°C)**

Male NPTF	Female NPTF	PSI	Zinc Plated Steel	
			Part #	Price/E
1/4"-18	1/8"-27	5000	5406-4-2	\$1.45
3/8"-18	1/8"-27	4000	5406-6-2	1.60
3/8"-18	1/4"-18	4000	5406-6-4	1.60
1/2"-14	1/8"-27	3000	5406-8-2	2.60
1/2"-14	1/4"-18	3000	5406-8-4	2.55
1/2"-14	3/8"-18	3000	5406-8-6	2.55
3/4"-14	1/8"-27	2500	5406-12-2	4.35
3/4"-14	1/4"-18	2500	5406-12-4	4.20
3/4"-14	3/8"-18	2500	5406-12-6	3.85
3/4"-14	1/2"-14	2500	5406-12-8	3.85
1"-11½	1/4"-18	2000	5406-16-4	7.50
1"-11½	3/8"-18	2000	5406-16-6	7.50
1"-11½	1/2"-14	2000	5406-16-8	7.25
1"-11½	3/4"-14	2000	5406-16-12	7.25
1¼"-11½	3/8"-18	1150	5406-20-6	14.75
1¼"-11½	1/2"-14	1150	5406-20-8	14.75
1¼"-11½	3/4"-14	1150	5406-20-12	14.75
1¼"-11½	1"-11½	1150	5406-20-16	13.90
1½"-11½	1/2"-14	1000	5406-24-8	21.05
1½"-11½	3/4"-14	1000	5406-24-12	16.80
1½"-11½	1"-11½	1000	5406-24-16	16.80
1½"-11½	1¼"-11½	1000	5406-24-20	18.10
2"-11½"	1/2"-14	1000	5406-32-8	66.25
2"-11½"	3/4"-14	1000	5406-32-12	37.35
2"-11½"	1"-11½	1000	5406-32-16	37.35
2"-11½"	1¼"-11½	1000	5406-32-20	37.35
2"-11½"	1½"-11½	1000	5406-32-24	37.35



Features:

- compact design provides ease of assembly in confining areas
- designed to prevent hose stress due to twisting during assembly
- female NPSM swivel seals on a 30° seat
- male NPTF must have a 30° chamfer to seal

Male NPTF x Female NPSM Swivel Nuts

Features:

- reference SAE 140130
- pressure rating at **70°F (21°C)**

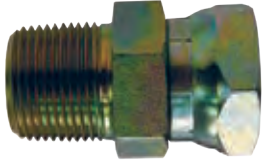

Male NPTF	Female NPSM Swivel	PSI	Zinc Plated Steel	
			Part #	Price/E
1/8"-27	1/8"-27	5000	1404-2-2	\$2.55
1/8"-27	1/4"-18	4500	1404-2-4	3.10
1/4"-18	1/4"-18	4500	1404-4-4	2.90
1/4"-18	3/8"-18	4000	1404-4-6	3.85
3/8"-18	1/4"-18	4000	1404-6-4	3.90
3/8"-18	3/8"-18	4000	1404-6-6	3.80
3/8"-18	1/2"-14	4000	1404-6-8	5.10
1/2"-14	3/8"-18	3000	1404-8-6	4.90
1/2"-14	1/2"-14	3000	1404-8-8	4.75
1/2"-14	3/4"-14	3000	1404-8-12	9.30
3/4"-14	1/2"-14	2500	1404-12-8	8.80
3/4"-14	3/4"-14	2500	1404-12-12	8.55
1"-11 1/2	1"-11 1/2	2000	1404-16-16	11.55
1 1/4"-11 1/2	1 1/4"-11 1/2	1150	1404-20-20	23.95
1 1/2"-11 1/2	1 1/2"-11 1/2	1000	1404-24-24	38.25
2"-11 1/2	2"-11 1/2	1000	1404-32-32	54.15

Female NPTF Hex Pipe Couplings

Features:

- reference SAE 140138
- pressure rating at **70°F (21°C)**



Female NPTF	Female NPTF	PSI	Zinc Plated Steel	
			Part #	Price/E
1/8"-27	1/8"-27	5000	5000-2	\$1.60
1/4"-18	1/4"-18	5000	5000-4	2.00
3/8"-18	3/8"-18	4000	5000-6-4	2.65
3/8"-18	3/8"-18	4000	5000-6	2.45
1/2"-14	3/8"-18	3000	5000-8-6	3.70
1/2"-14	1/2"-14	3000	5000-8	3.40
3/4"-14	3/4"-14	2500	5000-12	4.45
1"-11 1/2	3/4"-14	2000	5000-16-12	9.30
1"-11 1/2	1"-11 1/2	2000	5000-16	8.75
1 1/4"-11 1/2	1 1/4"-11 1/2	1150	5000-20	20.70

Female NPTF x Female NPSM Swivel Nuts

Features:

- reference SAE 140131
- pressure rating at **70°F (21°C)**



Female NPTF	Female NPSM Swivel	PSI	Zinc Plated Steel	
			Part #	Price/E
1/8"-27	1/8"-27	5000	1405-2-2	\$3.55
1/4"-18	1/4"-18	4500	1405-4-4	3.75
3/8"-18	1/4"-18	4000	1405-6-4	5.00
3/8"-18	3/8"-18	4000	1405-6-6	5.55
3/8"-18	1/2"-14	4000	1405-6-8	6.10
1/2"-14	3/8"-18	3000	1405-8-8	5.95
3/4"-14	1/2"-14	2500	1405-12-8	8.05
3/4"-14	3/4"-14	2500	1405-12-12	10.55
1"-11 1/2	1"-11 1/2	2000	1405-16-16	16.40
1 1/4"-11 1/2	1 1/4"-11 1/2	1150	1405-20-20	27.10
1 1/2"-11 1/2	1 1/2"-11 1/2	1000	1405-24-24	27.50
2"-11 1/2	2"-11 1/2	1000	1405-32-32	72.25

90° Male NPTF x Male NPTF Elbows

Features:

- reference SAE 140237
- pressure rating at **70°F (21°C)**



Male NPTF	Male NPTF	PSI	Zinc Plated Steel	
			Part #	Price/E
1/4"-18	1/4"-18	5000	5500-4	\$3.45
3/8"-18	3/8"-18	4000	5500-6	4.25
1/2"-14	1/2"-14	3000	5500-8	6.05
3/4"-14	3/4"-14	2500	5500-12	10.00
1"-11 1/2	1"-11 1/2	2000	5500-16	12.55

Features:

90° Male NPTF x Female NPTF Street Elbows

- reference 140239
- pressure rating at 70°F (21°C)

Male NPTF	Female NPTF	PSI	Zinc Plated Steel	
			Part #	Price/E
¼"-18	¼"-18	5000	5502-4	\$5.55
⅜"-18	⅜"-18	4000	5502-6	6.45
½"-14	½"-14	3000	5502-8	7.35
¾"-14	¾"-14	2500	5502-12	10.35
1"-11½	1"-11½	2000	5502-16	16.70
1¼"-11½	1¼"-11½	1150	5502-20	23.70



90° Male NPTF x Female NPSM Swivel Nut Elbows

Features:

- reference SAE 140230
- pressure rating at 70°F (21°C)

Male NPTF	Female NPSM Swivel	PSI	Zinc Plated Steel	
			Part #	Price/E
⅛"-27	⅛"-27	5000	1501-2-2	\$4.00
¼"-18	¼"-18	4500	1501-4-4	4.45
¼"-18	⅜"-18	4000	1501-4-6	6.20
⅜"-18	¼"-18	4000	1501-6-4	6.45
⅜"-18	⅜"-18	4000	1501-6-6	6.70
⅜"-18	½"-14	4000	1501-6-8	7.45
½"-14	⅜"-18	3000	1501-8-6	6.85
½"-14	½"-14	3000	1501-8-8	8.25
½"-14	¾"-14	3000	1501-8-12	11.85
¾"-14	½"-14	2500	1501-12-8	12.00
¾"-14	¾"-14	2500	1501-12-12	13.85
¾"-14	1"-11½	2000	1501-12-16	21.20
1"-11½	¾"-14	2000	1501-16-12	20.80
1"-11½	1"-11½	2000	1501-16-16	18.20
1"-11½	1¼"-11½	1150	1501-16-20	37.60
1¼"-11½	1¼"-11½	1150	1501-20-20	34.15



90° Female NPTF Pipe Elbows

Features:

- reference SAE 140237
- pressure rating at 70°F (21°C)

Female NPTF	Female NPTF	PSI	Zinc Plated Steel	
			Part #	Price/E
⅛"-27	⅛"-27	5000	5504-2	\$3.45
¼"-18	¼"-18	5000	5504-4	3.15
⅜"-18	⅜"-18	4000	5504-6	4.75
½"-14	½"-14	3000	5504-8	7.80
¾"-14	¾"-14	2500	5504-12	11.50
1"-11½	1"-11½	2000	5504-16	18.65



90° Female NPTF x Female NPSM Swivel Nut Elbows

Features:

- reference SAE 140251
- pressure rating at 70°F (21°C)

Female NPTF	Female NPSM Swivel	PSI	Zinc Plated Steel	
			Part #	Price/E
¼"-18	¼"-18	4500	1502-4-4	\$6.30
⅜"-18	⅜"-18	4000	1502-6-6	7.45
½"-14	½"-14	3000	1502-8-8	10.35
¾"-14	¾"-14	2500	1502-12-12	12.45
1"-11½	1"-11½	2000	1502-16-16	21.55



45° Male NPTF x Female NPSM Swivel Nut Elbows

Features:

- reference SAE 140330
- pressure rating at 70°F (21°C)

Male NPTF	Female NPSM Swivel	PSI	Zinc Plated Steel	
			Part #	Price/E
¼"-18	¼"-18	4500	1503-4-4	\$4.50
⅜"-18	⅜"-18	4000	1503-6-6	6.50
½"-14	½"-14	3000	1503-8-8	8.65
¾"-14	¾"-14	2500	1503-12-12	10.80
1"-11½	1"-11½	2000	1503-16-16	16.85





Male NPTF Pipe Tees

Features:

- reference SAE 140437
- pressure rating at 70°F (21°C)

Male NPTF (3)	PSI	Zinc Plated Steel	
		Part #	Price/E
1/4"-18	5000	5600-4	\$5.90
3/8"-18	4000	5600-6	10.45
1/2"-14	3000	5600-8	12.95
3/4"-14	2500	5600-12	16.20
1"-11 1/2	2000	5600-16	23.50

Male NPTF x Female NPTF Pipe Tees

Features:

- reference SAE 140427
- pressure rating at 70°F (21°C)



Male NPTF (2)	Female NPTF	PSI	Zinc Plated Steel	
			Part #	Price/E
1/4"-18	1/4"-18	5000	5601-4	\$8.30
3/8"-18	3/8"-18	4000	5601-6	10.20
1/2"-14	1/2"-14	3000	5601-8	12.70
3/4"-14	3/4"-14	2500	5601-12	20.55
1"-11 1/2	1"-11 1/2	2000	5601-16	32.05

Female NPTF x Male NPTF Branch Tees

Features:

- reference SAE 140425
- pressure rating at 70°F (21°C)



Female NPTF (2)	Male NPTF	PSI	Zinc Plated Steel	
			Part #	Price/E
1/4"-18	1/4"-18	5000	5604-4	\$7.00
3/8"-18	3/8"-18	4000	5604-6	9.95
1/2"-14	1/2"-14	3000	5604-8	13.55
3/4"-14	3/4"-14	2500	5604-12	18.60
1"-11 1/2	1"-11 1/2	2000	5604-16	29.95

Female NPTF Pipe Tees

Features:

- reference 140438
- pressure rating at 70°F (21°C)



Female NPTF (3)	PSI	Zinc Plated Steel	
		Part #	Price/E
1/4"-18	5000	5605-4	\$8.45
3/8"-18	4000	5605-6	10.35
1/2"-14	3000	5605-8	11.60
3/4"-14	2500	5605-12	17.30
1"-11 1/2	2000	5605-16	27.45

Female NPTF Pipe Tees

Features:

- reference 140424
- pressure rating at 70°F (21°C)



Male NPTF	Female NPTF (2)	PSI	Zinc Plated Steel	
			Part #	Price/E
1/8"-27	1/8"-27	5000	5602-2	\$4.60
1/4"-18	1/4"-18	5000	5602-4	5.70
3/8"-18	3/8"-18	4000	5602-6	10.35
1/2"-14	1/2"-14	3000	5602-8	13.50
3/4"-14	3/4"-14	2500	5602-12	16.95
1"-11 1/2	1"-11 1/2	2000	5602-16	30.25
1-1/4"-11 1/2	1-1/4"-11 1/2	1150	5602-20	44.85
1-1/2"-11 1/2	1-1/2"-11 1/2	1000	5602-24	279.95

Female NPTF Hex Caps

Feature:

- pressure rating at 70°F (21°C)

Female NPTF	PSI	Zinc Plated Steel	
		Part #	Price/E
1/8"-27	5000	5406C-2	\$1.45
1/4"-18	5000	5406C-4	1.85
3/8"-18	4000	5406C-6	2.65
1/2"-14	3000	5406C-8	4.20
3/4"-14	2500	5406C-12	6.35
1"-11 1/2	2000	5406C-16	9.65
1 1/4"-11 1/2	1150	5406C-20	49.15
1 1/2"-11 1/2	1000	5406C-24	66.60



Male NPTF Hex Plugs

Features:

- reference SAE 130109C
- pressure rating at 70°F (21°C)

Male NPTF	PSI	Zinc Plated Steel	
		Part #	Price/E
1/8"-27	5000	1251-02H	\$0.50
1/4"-18	5000	1251-04H	0.85
3/8"-18	4000	1251-06H	1.50
1/2"-14	3000	1251-08H	2.45
3/4"-14	2500	1251-12H	3.80
1"-11 1/2	2000	1251-16H	7.05
1 1/4"-11 1/2	1150	1251-20H	8.30



Male JIC 37° Flare x Male Metric Parallel Thread

Feature:

- pressure rating at 70°F (21°C)

Male JIC 37° Flare	Male Metric Parallel	Zinc Plated Steel	
		Part #	Price/E
7/16"-20	M10X1.0	M7400-4-10	\$3.50
7/16"-20	M12X1.5	M7400-4-12	3.65
9/16"-18	M14X1.5	M7400-6-14	3.85
9/16"-18	M16X1.5	M7400-6-16	4.30
3/4"-16	M16X1.5	M7400-8-16	4.45
3/4"-16	M18X1.5	M7400-8-18	5.65
1-1/16"-12	M22X1.5	M7400-12-22	6.45
1-1/16"-12	M27X2.0	M7400-12-27	7.85
1-5/16"-12	M33X2.0	M7400-16-33	11.80



Female NPTF Pipe x Male Metric Parallel Thread

Feature:

- pressure rating at 70°F (21°C)

Female NPTF	Male Metric Parallel	Zinc Plated Steel	
		Part #	Price/E
1/4"-18	M12X1.5	M7455-4-12	\$3.85
1/4"-18	M14X1.5	M7455-4-14	4.00
3/8"-18	M16X1.5	M7455-6-16	4.30
3/8"-18	M18X1.5	M7455-6-18	5.65
1/2"-14	M16X1.5	M7455-8-16	7.15
1/2"-14	M18X1.5	M7455-8-18	7.15
1/2"-14	M22X1.5	M7455-8-22	7.50
3/4"-14	M27X2.0	M7455-12-27	11.25
1"-11 1/2	M33X2.0	M7455-16-33	12.50



British Thread Adapter Male JIC 37° Flare x Male BSPP

Feature:

- pressure rating at 70°F (21°C)



Male JIC 37° Flare	Male BSPP	PSI	Zinc Plated Steel	
			Part #	Price/E
7/16"-20	1/4"-19	5000	B3800-4-4	\$3.30
9/16"-18	3/8"-19	4000	B3800-6-6	3.60
3/4"-16	1/2"-14	3000	B3800-8-8	4.90
1-1/16"-12	3/4"-14	2500	B3800-12-12	9.05
1-5/16"-12	1"-11	2000	B3800-16-16	10.60

British Thread Adapter Male NPTF x Male BSPP

Feature:

- pressure rating at 70°F (21°C)



Male NPTF	Male BSPP	PSI	Zinc Plated Steel	
			Part #	Price/E
1/4"-18	1/4"-19	5000	B3401-4-4	\$3.30
3/8"-18	3/8"-19	4000	B3401-6-6	3.70
1/2"-14	1/2"-14	3000	B3401-8-8	4.60
3/4"-14	3/4"-14	2500	B3401-12-12	7.80
1"-11 1/2	1"-11	2000	B3401-16-16	11.60

British Thread Adapter Female NPTF x Male BSPP

Feature:

- pressure rating at 70°F (21°C)



Female NPTF	Male BSPP	PSI	Zinc Plated Steel	
			Part #	Price/E
1/4"-18	1/4"-19	5000	B3455-4-4	\$3.85
3/8"-18	3/8"-19	4000	B3455-6-6	4.30
1/2"-14	1/2"-14	3000	B3455-8-8	7.15
3/4"-14	3/4"-14	2500	B3455-12-12	10.60
1"-11 1/2	1"-11	2000	B3455-16-16	13.30

British Thread Adapter Male JIC 37° Flare x Male BSPP 90° Elbow

Feature:

- pressure rating at 70°F (21°C)



Male JIC 37° Flare	Male BSPP	PSI	Zinc Plated Steel	
			Part #	Price/E
7/16"-20	1/4"-19	5000	B3801-4-4	\$6.80
9/16"-18	3/8"-19	4000	B3801-6-6	8.15
3/4"-16	1/2"-14	3000	B3801-8-8	11.80
1-1/16"-12	3/4"-14	2500	B3801-12-12	19.40
1-5/16"-12	1"-11	2000	B3801-16-16	32.50

Bonded Doughty Seal for British Thread

Feature:

- pressure rating at 70°F (21°C)



Size	Plated Carbon Steel with Buna O-ring	
	Part #	Price/E
1/4"-18	BDS04	\$1.25
3/8"-18	BDS06	1.50
1/2"-14	BDS08	1.80
3/4"-14	BDS12	2.30
1"-11 1/2	BDS16	3.50

Hydraulic 4-Bolt Flanges

Features:

- flat face flange must be used with O-ring flange
- code 61 - standard pressure; code 62 - high pressure
- makes installation of components easier, especially in applications with limited space
- bolt kit with Buna O-ring included with O-ring flange
- no bolt kit is included with flat face flange
- also available in 316L stainless, contact Dixon® for more information

Hydraulic 4-Bolt Flange NPTF Port

Port Size	Pad Size	NPTF Thread	Code 61 Carbon Steel			
			O-ring Part #	Price/E	Flat Face Part #	Price/E
1/2"	1/2"	1/2"-14	W43-8-8-U	\$35.50	W104-8-8	\$39.60
3/4"	3/4"	3/4"-14	W43-12-12-U	29.55	W104-12-12	27.30
1"	1"	1"-11 1/2	W43-16-16-U	32.50	W104-16-16	29.20
1 1/4"	1 1/4"	1 1/4"-11 1/2	W43-20-20-U	36.65	W104-20-20	31.55
1 1/2"	1 1/2"	1 1/2"-11 1/2	W43-24-24-U	43.75	W104-24-24	34.30
2"	2"	2"-11 1/2	W43-32-32-U	57.00	W104-32-32	49.05
2 1/2"	2 1/2"	2 1/2"-8	W43-40-40-U	81.10	W104-40-40	76.45
3"	3"	3"-8	W43-48-48-U	118.45	W104-48-48	118.45

Port Size	Pad Size	NPTF Thread	Code 62 Carbon Steel			
			O-ring Part #	Price/E	Flat Face Part #	Price/E
1/2"	1/2"	1/2"-14	W44-8-8-U	\$57.45	W45-8-8	\$59.35
3/4"	3/4"	3/4"-14	W44-12-12-U	61.70	W45-12-12	57.95
1"	1"	1"-11 1/2	W44-16-16-U	70.90	W45-16-16	64.20
1 1/4"	1 1/4"	1 1/4"-11 1/2	W44-20-20-U	91.00	W45-20-20	82.75
1 1/2"	1 1/2"	1 1/2"-11 1/2	W44-24-24-U	135.45	W45-24-24	110.40
2"	2"	2"-11 1/2	W44-32-32-U	201.15	W45-32-32	166.65
2 1/2"	2 1/2"	2 1/2"-8	---	---	---	---
3"	3"	3"-8	---	---	---	---



Hydraulic 4-Bolt Flange SAE Port

Port Size	Pad Size	UN / UNF-2B Thread	Code 61 Carbon Steel			
			O-ring Part #	Price/E	Flat Face Part #	Price/E
1/2"	1/2"	3/4"-16	W46-8-8-U	\$53.20	W106-8-8	\$49.65
3/4"	3/4"	1-1/16"-12	W46-12-12-U	32.65	W106-12-12	29.35
1"	1"	1-5/16"-12	W46-16-16-U	33.60	W106-16-16	30.30
1 1/4"	1 1/4"	1 5/8"-12	W46-20-20-U	41.60	W106-20-20	35.00
1 1/2"	1 1/2"	1 7/8"-12	W46-24-24-U	52.25	W106-24-24	46.35
2"	2"	2 1/2"-12	W46-32-32-U ¹	153.65	W106-32-32	172.55

¹ 1000 PSI maximum

Port Size	Pad Size	UN / UNF-2B Thread	Code 62 Carbon Steel			
			O-ring Part #	Price/E	Flat Face Part #	Price/E
1/2"	1/2"	3/4"-16	W48-8-8-U	\$55.10	W49-8-8	\$52.75
3/4"	3/4"	1-1/16"-12	W48-12-12-U	62.20	W49-12-12	57.95
1"	1"	1-5/16"-12	W48-16-16-U	70.00	W49-16-16	63.85
1 1/4"	1 1/4"	1 5/8"-12	W48-20-20-U	89.35	W49-20-20	82.75
1 1/2"	1 1/2"	1 7/8"-12	W48-24-24-U	128.85	W49-24-24	109.95
2"	2"	2 1/2"-12	W48-32-32-U	189.35	W49-32-32	167.85

- For flange dimensions, diagrams and additional information please reference dixonvalve.com.



Hydraulic Fittings



Hydraulic 4-Bolt Flange Pipe Socket Weld

Port Size	Pad Size	O-ring Part #	Code 61 Carbon Steel		
			Price/E	Flat Face Part #	Price/E
1/2"	1/2"	W4-8-8-U	\$34.30	W61-8-8	\$23.40
3/4"	3/4"	W4-12-12-U	32.40	W61-12-12	24.85
1"	1"	W4-16-16-U	33.60	W61-16-16	26.00
1 1/4"	1 1/4"	W4-20-20-U	38.10	W61-20-20	28.60
1 1/2"	1 1/2"	W4-24-24-U	47.25	W61-24-24	38.55
2"	2"	W4-32-32-U	73.30	W61-32-32	59.10
2 1/2"	2 1/2"	W4-40-40-U	106.40	W61-40-40	86.30
3"	3"	W4-48-48-U	118.45	W61-48-48	94.80

Port Size	Pad Size	O-ring Part #	Code 62 Carbon Steel		
			Price/E	Flat Face Part #	Price/E
1/2"	1/2"	W59-8-8-U	\$49.20	W60-8-8	\$39.00
3/4"	3/4"	W59-12-12-U	47.05	W60-12-12	44.20
1"	1"	W59-16-16-U	67.40	W60-16-16	57.45
1 1/4"	1 1/4"	W59-20-20-U	80.60	W60-20-20	73.30
1 1/2"	1 1/2"	W59-24-24-U	100.50	W60-24-24	92.20
2"	2"	W59-32-32-U	146.50	W60-32-32	125.30
2 1/2"	2 1/2"	W59-40-40-U	425.70	W60-40-40	354.55
3"	3"	W59-48-48-U	710.30	W60-48-48	709.10

Pressure Ratings of SAE Flanges

Code 61 SAE J518-1 / ISO 6162-1

Dash Size	Size	Maximum Working Pressure		Fastener Torque Value
		PSI	MPa	Grade 8 UNC (lb-ft)
-8	1/2"	5000	35	24
-12	3/4"	5000	35	44
-16	1"	4600	32	44
-20	1 1/4"	4000	28	68
-24	1 1/2"	3000	21	111
-32	2"	3000	21	111
-40	2 1/2"	2500	17.5	111
-48	3"	2300	16	218
-56	3 1/2"	500	3.5	218
-64	4"	500	3.5	218
-80	5"	500	3.5	218

- Connection type opposite 4-bolt flange connection can de-rate maximum working pressure.

Code 62 SAE J518-2 / ISO 6162-2

Dash Size	Size	Maximum Working Pressure		Fastener Torque Value
		PSI	MPa	Grade 8 UNC (lb-ft)
-8	1/2"	6000	40	24
-12	3/4"	6000	40	44
-16	1"	6000	40	68
-20	1 1/4"	6000	40	111
-24	1 1/2"	6000	40	218
-32	2"	6000	40	332
-40	2 1/2"	6000	40	380
-48	3"	6000	40	667

- For flange dimensions, diagrams and additional information please reference dixonvalve.com.

Hydraulic Split Flange Kits

Features:

- for tube, hose end and split flange adapter connections
- kits include 2 split flange halves, 4 hex head screws and lockwashers, 1 Buna O-ring
- silver trivalent finish for high corrosion resistance
- also available in forged 316L stainless, contact Dixon® for more information

Flange Size	Code 61 Forged Carbon Steel		Code 62 Forged Carbon Steel	
	Part #	Price/E	Part #	Price/E
1/2"	8SFO	\$20.15	8SFXO	\$22.00
3/4"	12SFO	11.15	12SFXO	20.10
1"	16SFO	12.55	16SFXO	23.60
1 1/4"	20SFO	15.85	20SFXO	32.90
1 1/2"	24SFO	19.90	24SFXO	47.55
2"	32SFO	21.30	32SFXO	80.15
2 1/2"	40SFO	47.40	---	---
3"	48SFO	79.65	---	---



Hydraulic Code 61 / Code 62 Flange Adapters

Straight SAE x Male JIC Hydraulic Adapter

JIC Thread	Tube OD	Flange Size	Code 61 Carbon Steel		Code 62 Carbon Steel	
			Part #	Price/E	Part #	Price/E
3/4"-16	1/2"	1/2"	300-8-8	\$15.40	---	---
3/4"-16	1/2"	3/4"	300-8-12	26.25	---	---
1-1/16"-12	3/4"	3/4"	300-12-12	16.55	600-12-12	\$20.10
1-1/16"-12	3/4"	1"	300-12-16	19.15	600-12-16	24.35
1-5/16"-12	1"	3/4"	300-16-12	18.20	600-16-12	24.85
1-5/16"-12	1"	1"	300-16-16	18.85	600-16-16	23.90
1-5/16"-12	1"	1 1/4"	300-16-20	22.00	600-16-20	31.45
1 5/8"-12	1 1/4"	1"	300-20-16	22.00	600-20-16	32.40
1 5/8"-12	1 1/4"	1 1/4"	300-20-20	23.90	600-20-20	32.65
1 5/8"-12	1 1/4"	1 1/2"	300-20-24	35.25	600-20-24	44.00
1 7/8"-12	1 1/2"	1 1/4"	300-24-20	30.05	600-24-20	39.95
1 7/8"-12	1 1/2"	1 1/2"	300-24-24	29.55	600-24-24	39.50
1 7/8"-12	1 1/2"	2"	300-24-32	48.55	600-24-32	62.65
2 1/2"-12	2"	1 1/2"	300-32-24	53.35	600-32-24	54.60
2 1/2"-12	2"	2"	300-32-32	47.25	600-32-32	63.85



90° SAE Elbow x Male JIC Hydraulic Adapter

JIC Thread	Tube OD	Flange Size	Code 61 Carbon Steel		Code 62 Carbon Steel	
			Part #	Price/E	Part #	Price/E
3/4"-16	1/2"	3/4"	390-8-12	\$23.90	---	---
1-1/16"-12	3/4"	3/4"	390-12-12	19.15	690-12-12	\$28.60
1-1/16"-12	3/4"	1"	390-12-16	26.75	690-12-16	35.70
1-5/16"-12	1"	3/4"	390-16-12	26.75	690-16-12	30.75
1-5/16"-12	1"	1"	390-16-16	25.80	690-16-16	31.00
1-5/16"-12	1"	1 1/4"	390-16-20	33.35	690-16-20	42.80
1 5/8"-12	1 1/4"	1"	390-20-16	31.45	690-20-16	38.10
1 5/8"-12	1 1/4"	1 1/4"	390-20-20	33.80	690-20-20	40.45
1 5/8"-12	1 1/4"	1 1/2"	390-20-24	48.00	690-20-24	60.05
1 7/8"-12	1 1/2"	1 1/2"	390-24-24	46.10	690-24-24	58.90
1 7/8"-12	1 1/2"	2"	390-24-32	82.75	690-24-32	96.20
2 1/2"-12	2"	1 1/2"	390-32-24	57.95	690-32-24	67.40
2 1/2"-12	2"	2"	390-32-32	79.70	690-32-32	96.20



45° SAE Elbow x Male JIC Hydraulic Adapter

JIC Thread	Tube OD	Flange Size	Code 61 Carbon Steel		Code 62 Carbon Steel	
			Part #	Price/E	Part #	Price/E
1-1/16"-12	3/4"	3/4"	340-12-12	\$19.65	640-12-12	\$25.40
1-5/16"-12	1"	1"	340-16-16	22.95	640-16-16	32.40
1 5/8"-12	1 1/4"	1 1/4"	340-20-20	29.55	640-20-20	38.55
1 7/8"-12	1 1/2"	1 1/2"	340-24-24	43.75	640-24-24	49.90
2 1/2"-12	2"	2"	340-32-32	78.35	640-32-32	118.45



Hydraulic Suction and Return Line Hose Couplings

Application:

- designed for hydraulic suction line applications using SAE100R4 hydraulic hose

Feature:

- barbs provide easy assembly and maximum gripping action

Hydraulic Suction and Return Line Female SAE Stem

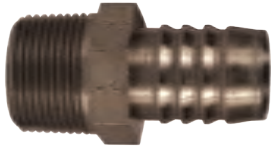

Hose ID	Male NPTF	Plated Steel	
		Part #	Price/E
3/4"	3/4"-14	188-12	\$15.00
1"	1"-11½	188-16	36.00
1¼"	1¼"-11½	188-20	68.10
1½"	1½"-11½	188-24	84.00
2"	2"-11½	188-32	129.00

Hydraulic Suction and Return Line Female SAE 37° Swivel Stem



Hose ID	Male NPTF	Plated Steel	
		Part #	Price/E
3/4"	1-1/16"-12	688-12	\$21.00
1"	1-5/16"-12	688-16	43.00
1¼"	1⅝"-12	688-20	92.00
1½"	1⅞"-12	688-24	100.00
2"	2½"-12	688-32	196.00

- return line clamps must be used with these fittings
- reference clamps on page F-10

Hydraulic Hose Stems

Feature:

- stems have a collar behind the hex to engage clamp fingers
- reference clamps on page C-10, C-11



NPTF Size	Plated Steel	
	Part #	Price/E
3/8"	MSC	\$6.55
1/2"	HY4	17.70
3/4"	MS6	9.85
1"	HY8	25.00



NPTF Size	Plated Steel	
	Part #	Price/E
1¼"	HY10	\$35.60
1½"	HY12	41.00
2"	HY16	46.85

Inline Hydraulic Filters

Features:

- provides protection for small, high pressure systems
- installs at the pressure side of a pump
- conically shaped bronze element positioned by a retaining spring to allow true, uninterrupted flow
- standard 25 micron bronze element can be easily cleaned or replaced
- temperature range: **35°F to 200°F (2°C to 93°C)**
- maximum operating pressure: **3000 PSI**



Female SAE	Overall Length	Diameter	Plated Steel	
			Part #	Price/E
9/16" - 16	3¼"	1½"	9152	\$59.60
¾" - 16	3¼"	1½"	9153	59.60

Nominal Fittings

Crimp Collars for all Nominal fittings are included

- for use with PTFE hoses on pages L-37 and L-38

Nominal Female JIC Swivels

Hose Size	Thread Size	Carbon Steel		304 Stainless Steel		Brass	
		Part #	Price/E	Part #	Price/E	Part #	Price/E
dash 4	1/4"	FJC-04-04	\$7.30	FJS-04-04	\$19.05	FJB-04-04	\$6.20
dash 5	5/16"	FJC-05-05	12.45	FJS-05-05	21.70	FJB-05-05	8.80
dash 6	3/8"	FJC-06-06	13.85	FJS-06-06	25.05	FJB-06-06	10.20
dash 8	1/2"	FJC-08-08	13.95	FJS-08-08	33.85	FJB-08-08	12.50
dash 10	5/8"	FJC-10-10	16.20	FJS-10-10	44.80	FJB-10-10	23.50
dash 12	3/4"	FJC-12-12	22.85	FJS-12-12	64.20	FJB-12-12	30.70
dash 16	1"	FJC-16-16	36.10	FJS-16-16	113.40	FJB-16-16	43.60
dash 20Z	1 1/4"	FJC-20Z-20	114.30	FJS-20Z-20	293.40	FJB-20Z-20	153.00



Nominal Rigid Male Pipe Fittings

Hose Size	Thread Size	Carbon Steel		304 Stainless Steel		Brass	
		Part #	Price/E	Part #	Price/E	Part #	Price/E
dash 4	1/8"	MPC-04-02	\$6.45	MPS-04-02	\$12.10	MPB-04-02	\$5.60
dash 4	1/4"	MPC-04-04	6.40	MPS-04-04	14.85	MPB-04-04	5.90
dash 5	1/4"	MPC-05-04	8.05	MPS-05-04	13.95	MPB-05-04	7.10
dash 6	1/4"	MPC-06-04	10.70	MPS-06-04	20.45	MPB-06-04	10.15
dash 6	3/8"	MPC-06-06	8.35	MPS-06-06	17.10	MPB-06-06	9.00
dash 8	3/8"	MPC-08-06	11.85	MPS-08-06	27.80	MPB-08-06	13.95
dash 8	1/2"	MPC-08-08	11.85	MPS-08-08	28.35	MPB-08-08	13.50
dash 10	1/2"	MPC-10-08	21.15	MPS-10-08	29.70	MPB-10-08	14.70
dash 12	3/4"	MPC-12-12	21.05	MPS-12-12	46.85	MPB-12-12	28.30
dash 16	1"	MPC-16-16	38.95	MPS-16-16	100.15	MPB-16-16	51.40
dash 20Z	1 1/4"	MPC-20Z-20	157.50	MPS-20Z-20	185.25	MPB-20Z-20	207.00



Female SAE Swivels

Hose Size	Thread Size	Carbon Steel		Brass	
		Part #	Price/E	Part #	Price/E
dash 6	3/8"	SAEC-06-06	\$17.65	SAEB-06-06	\$11.40
dash 12	3/4"	SAEC-12-12	24.75	SAEB-12-12	33.80



Nominal PTFE Hose Insertion Tool and Dies

Feature:

- takes the hassle out of installing crimp collars onto braided PTFE Hose; with a few simple steps even challenging braid can be easily and safely inserted into the crimp collar

Description	Size	Part #	Price/E
tool / die holder	---	ITDH	\$350.00
die	dash 4	ITD-04	206.00
die	dash 5	ITD-05	206.00
die	dash 6	ITD-06	206.00
die	dash 8	ITD-08	206.00
die	dash 10	ITD-10	206.00
die	dash 12	ITD-12	206.00
die	dash 16	ITD-16	206.00



Nominal Smooth Bore PTFE Hose Fittings

Crimp Collars for all Nominal fittings are included

- for use with PTFE hoses on pages L-37 and L-38

Nominal Smooth Bore PTFE Hose Tube End Stubs



Hose Size	Tube Size	304 Stainless Steel	
		Part #	Price/E
dash 4	1/4"	TES-04-04	\$21.40
dash 6	3/8"	TES-06-06	26.30
dash 8	1/2"	TES-08-08	45.15
dash 12	3/4"	TES-12-12	129.20
dash 16	1"	TES-16-16	137.90

Nominal Smooth Bore PTFE Hose 45° FJIC Fittings



Hose Size	Thread Size	304 Stainless Steel		Carbon Steel	
		Part #	Price/E	Part #	Price/E
dash 3	3/16"	FJS45-03-03	\$55.75	FJC45-03-03	\$21.05
dash 4	1/4"	FJS45-04-04	62.25	FJC45-04-04	23.90
dash 5	5/16"	FJS45-05-05	63.60	FJC45-05-05	24.25
dash 6	3/8"	FJS45-06-06	69.75	FJC45-06-06	27.10
dash 8	1/2"	FJS45-08-08	86.85	FJC45-08-08	32.85
dash 10	5/8"	FJS45-10-10	97.20	FJC45-10-10	37.95
dash 12	3/4"	FJS45-12-12	122.65	FJC45-12-12	52.20
dash 16	1"	FJS45-16-16	197.95	FJC45-16-16	68.80
dash 20Z	1 1/4"	FJS45-20Z-20	266.65	FJC45-20Z-20	103.70

Nominal Smooth Bore PTFE Hose 90° FJIC Fittings



Hose Size	Thread Size	304 Stainless Steel		Carbon Steel	
		Part #	Price/E	Part #	Price/E
dash 3	3/16"	FJS90-03-03	\$55.75	FJC90-03-03	\$21.05
dash 4	1/4"	FJS90-04-04	62.25	FJC90-04-04	23.90
dash 5	5/16"	FJS90-05-05	63.60	FJC90-05-05	24.25
dash 6	3/8"	FJS90-06-06	69.75	FJC90-06-06	27.10
dash 8	1/2"	FJS90-08-08	86.85	FJC90-08-08	32.85
dash 10	5/8"	FJS90-10-10	97.20	FJC90-10-10	37.95
dash 12	3/4"	FJS90-12-12	122.65	FJC90-12-12	52.20
dash 16	1"	FJS90-16-16	197.95	FJC90-16-16	68.80
dash 20Z	1 1/4"	FJS90-20Z-20	266.65	FJC90-20Z-20	103.70

True ID Fittings

Crimp collars for all True ID fittings are sold separately

True ID Female JIC Swivels



Size	Carbon Steel		316 Stainless Steel	
	Part #	Price/E	Part #	Price/E
1/4"	FJC-T04	\$11.10	FJR-T04	\$25.45
3/8"	FJC-T06	12.10	FJR-T06	33.30
1/2"	FJC-T08	20.05	FJR-T08	40.05
3/4"	FJC-T12	23.05	FJR-T12	59.55
1"	FJC-T16	29.40	FJR-T16	103.35
1 1/4"	FJC-T20	78.30	FJR-T20	212.40
1 1/2"	FJC-T24	75.15	FJR-T24	267.80
2"	FJC-T32	141.65	FJR-T32	445.80

True ID Rigid Male Pipe Fittings



Size	Carbon Steel		316 Stainless Steel	
	Part #	Price/E	Part #	Price/E
1/4"	MPC-T04	\$5.70	MPR-T04	\$21.60
3/8"	MPC-T06	7.85	MPR-T06	28.60
1/2"	MPC-T08	16.90	MPR-T08	37.35
3/4"	MPC-T12	20.25	MPR-T12	59.45
1"	MPC-T16	31.30	MPR-T16	104.75
1 1/4"	MPC-T20	53.10	MPR-T20	185.40
1 1/2"	MPC-T24	60.30	MPR-T24	211.50
2"	MPC-T32	101.70	MPR-T32	333.00

- for use with PTFE hoses on pages L-37 and L-38

True ID Sanitary Tri-Clamps

Hose Size	Clamp Size	316 Stainless Steel	
		Part #	Price/E
1/2"	1"	TCR-T08-16	\$128.95
1/2"	1 1/2"	TCR-T08-24	150.65
3/4"	1 1/2"	TCR-T12-24	161.50
1"	1"	TCR-T16-16	120.60
1"	1 1/2"	TCR-T16-24	138.90
1 1/2"	1 1/2"	TCR-T24-24	150.65
2"	2"	TCR-T32-32	200.75



Hydraulic Fittings

True ID Mini Sanitary Tri-Clamps

Size	316 Stainless Steel	
	Part #	Price/E
1/2"	TCMR-T08	\$56.70
3/4"	TCMR-T12	70.22



- contact Dixon® for GSM and PTFE hose assemblies

True ID Flange Retainers

Feature:

- for use with lap joint flanges, see page J-36

Size	316 Stainless Steel		316 Stainless Steel PTFE Encapsulated	
	Part #	Price/E	Part #	Price/E
1/2"	FRR-T08	\$97.45	---	---
3/4"	FRR-T12	116.55	FRRE-T12	\$326.10
1"	FRR-T16	146.80	FRRE-T16	492.70
1 1/4"	FRR-T20	225.00	FRRE-T20	616.50
1 1/2"	FRR-T24	287.45	FRRE-T24	585.00
2"	FRR-T32	510.60	FRRE-T32	976.60



Crimp Collars

Convuluted Crimp Collar

Features:

- for open pitch convuluted PTFE hose only
- new design for ease of installation and improved appearance of finished crimp

Size	Carbon Steel		304 Stainless Steel	
	Part #	Price/E	Part #	Price/E
1/4"	CSC-T04-1	\$5.40	SSC-T04-1	\$17.05
3/8"	CSC-T06-1	6.20	SSC-T06-1	18.45
1/2"	CSC-T08-1	11.40	SSC-T08-1	21.90
3/4"	CSC-T12-1	13.75	SSC-T12-1	31.55
1"	CSC-T16-1	15.35	SSC-T16-1	48.40
1 1/4"	CSC-T20-1	39.65	SSC-T20-1	78.30
1 1/2"	CSC-T24-1	45.85	SSC-T24-1	93.35
2"	CSC-T32-1	59.55	SSC-T32-1	157.80



Smooth Bore Crimp Collars

Features:

- for True ID smooth bore PTFE hose only
- new design for ease of installation and improved appearance of finished crimp

Size	Carbon Steel		304 Stainless Steel	
	Part #	Price/E	Part #	Price/E
1/4"	CSC-T04-2	\$5.40	SSC-T04-2	\$17.05
3/8"	CSC-T06-2	6.20	SSC-T06-2	18.45
1/2"	CSC-T08-2	11.40	SSC-T08-2	21.90
3/4"	CSC-T12-2	13.75	SSC-T12-2	31.55
1"	CSC-T16-2	15.35	SSC-T16-2	48.40
1 1/4"	CSC-T20-2	39.65	SSC-T20-2	78.30
1 1/2"	CSC-T24-2	44.65	SSC-T24-2	93.35



Contact Dixon® at 888.226.4673 for assembly instructions and crimp recommendations.

Pipe and Tube Clamps

Applications:

- standard hydraulic applications, general pipe construction, electric cables, etc.
- *Standard and twin series clamps* are recommended for systems with less than 1500 PSI without dynamic loads.
- *Heavy duty clamps* are recommended for systems with greater than 1500 PSI operating pressure.

Features:

- clamps are welded in place to secure the pipe or tubing
- polypropylene cushions reduce wear due to vibration
- kit includes clamp with weld plate, cover plate and bolts

Standard Series Pipe & Tube Clamp

Size	Length	Width	Height	Steel & Polypropylene	
				Part #	Price/E
1/8" pipe	1.65"	1.18"	1.30"	HST02P	\$5.50
1/4" pipe	1.89"	1.18"	1.54"	HST04P	6.55
1/4" tube	1.65"	1.18"	1.30"	HST04T	5.50
5/16" tube	1.65"	1.18"	1.30"	HST05T	5.50
3/8" pipe	1.89"	1.18"	1.54"	HST06P	6.55
3/8" tube	1.65"	1.18"	1.30"	HST06T	5.50
1/2" pipe	2.17"	1.18"	1.61"	HST08P	7.30
1/2" tube	1.89"	1.18"	1.54"	HST08T	6.55
5/8" tube	1.89"	1.18"	1.54"	HST10T	6.55
3/4" pipe	2.44"	1.18"	1.89"	HST12P	7.30
3/4" tube	2.17"	1.18"	1.61"	HST12T	6.95
7/8" tube	2.17"	1.18"	1.61"	HST14T	6.95
1" pipe	2.91"	1.18"	2.52"	HST16P	8.65
1" tube	2.17"	1.18"	1.61"	HST16T	6.95
1 1/4" pipe	2.91"	1.18"	2.52"	HST20P	8.65
1 1/4" tube	2.91"	1.18"	2.52"	HST20T	8.65
1 1/2" pipe	3.46"	1.18"	2.83"	HST24P	12.00
1 1/2" tube	2.91"	1.18"	2.52"	HST24T	8.70
2" tube	3.46"	1.18"	2.83"	HST32T	12.00

**Twin Series Pipe & Tube Clamp**

Size	Length	Width	Height	Steel & Polypropylene	
				Part #	Price/E
1/8" pipe	1.46"	1.18"	1.36"	HTW02P	\$6.70
1/4" pipe	1.46"	1.18"	1.36"	HTW04P	7.05
1/4" tube	1.46"	1.18"	1.36"	HTW04T	6.70
5/16" tube	1.46"	1.18"	1.36"	HTW05T	6.70
3/8" pipe	2.17"	1.18"	1.42"	HTW06P	7.05
3/8" tube	1.46"	1.18"	1.36"	HTW06T	6.70
1/2" pipe	2.76"	1.18"	1.85"	HTW08P	7.25
1/2" tube	2.17"	1.18"	1.42"	HTW08T	7.05
5/8" tube	2.17"	1.18"	1.42"	HTW10T	7.05
3/4" pipe	3.35"	1.18"	2.05"	HTW12P	8.65
3/4" tube	2.76"	1.18"	1.85"	HTW12T	7.25
7/8" tube	2.76"	1.18"	1.85"	HTW14T	7.25
1" pipe	4.33"	1.18"	2.52"	HTW16P	11.00
1" tube	2.76"	1.18"	1.85"	HTW16T	7.25
1 1/4" pipe	4.33"	1.18"	2.52"	HTW20P	11.00
1 1/4" tube	4.33"	1.18"	2.52"	HTW20T	11.00
1 1/2" tube	4.33"	1.18"	2.52"	HTW24T	11.00



Pipe and Tube Clamps, cont.

Heavy Duty Series Pipe & Tube Clamp

Size	Length	Width	Height	Steel & Polypropylene	
				Part #	Price/E
1/8" pipe	2.87"	1.18"	1.89"	HHD02P	\$14.25
1/4" pipe	2.87"	1.18"	1.89"	HHD04P	14.25
1/4" tube	2.87"	1.18"	1.89"	HHD04T	14.25
5/16" tube	2.87"	1.18"	1.89"	HHD05T	14.25
3/8" pipe	2.87"	1.18"	1.89"	HHD06P	14.25
3/8" tube	2.87"	1.18"	1.89"	HHD06T	14.25
1/2" pipe	3.35"	1.18"	2.52"	HHD08P	16.25
1/2" tube	2.87"	1.18"	1.89"	HHD08T	14.25
5/8" tube	2.87"	1.18"	1.89"	HHD10T	14.25
3/4" pipe	3.35"	1.18"	2.52"	HHD12P	16.25
3/4" tube	3.35"	1.18"	2.52"	HHD12T	16.25
7/8" tube	3.35"	1.18"	2.52"	HHD14T	16.25
1" pipe	3.94"	1.18"	2.99"	HHD16P	17.30
1" tube	3.35"	1.18"	2.52"	HHD16T	16.25
1 1/4" pipe	5.51"	1.77"	4.33"	HHD20P	45.00
1 1/4" tube	3.94"	1.18"	2.99"	HHD20T	17.30
1 1/2" pipe	5.51"	1.77"	4.33"	HHD24P	45.00
1 1/2" tube	3.94"	1.18"	2.99"	HHD24T	17.30
2" pipe	5.51"	1.77"	4.33"	HHD32P	45.00
2" tube	5.51"	1.77"	4.33"	HHD32T	45.00



Ball	I-2 to I-16
Bronze	I-2, I-3
Locking handle	I-3, I-5
Deadman spring return handle	I-3, I-11
250 lb. steam	I-4
Safety vented	I-4
With NPT tap for drain	I-4
Brass	I-5, I-6, I-7, I-8
Solder end	I-6
Lead free brass	I-6
Dual Y	I-7
Mini's	I-7
3-way diverting T and L flow	I-8
2-piece stainless	I-9
Stainless, full port	I-9, I-10
Stainless, reduced port	I-10
3-piece stainless industrial	I-11
Industrial wafer	I-12
Mann Tek full flow	I-12, I-13
Carbon steel	I-14
High pressure, full bore	I-14
150# flanged	I-15
Polypropylene	I-15, I-16

Gate

Globe

Butterfly

Control

Series F	I-20
Series MV	I-20
Series PF	I-21
Series N	I-21

Needle

Mini	I-22
Multiport	I-22
Block and bleed	I-23
Female x Female	I-25

Button & Tank Filler

External Drains

Check

Safety	I-26
Safety pop-off	I-27
Series C	I-28

Check, cont

Ball cone	I-28
800 PSI	I-29
Forged steel	I-29
Spring loaded	I-29, I-30
Swing	I-30

Fire Valves/Bldg. Connections.. I-31 to I-51

Angle valves	I-31 to I-34
Wedge disc gate valves	I-35 to I-36
Gate valves	I-37 to I-39
Wharf hydrants	I-40
Wye valves	I-40, I-41
2-way swivel inlet	I-42
Globe valves	I-43
Drip valves	I-43
Reducing angle valves	I-44
Globe valves	I-45
Pressure reducing valves	I-46, I-47
Adjustable pressure restricting devices	I-47
Adjustable pressure restricting angle valves	I-48
Backflow preventer	I-49
Groove x groove check valve	I-49
Chicago pattern valves	I-49
Sprinkler hose valve	I-50
Drain Valves	I-50
Piston intake relief valves	I-51
Butterfly valves	I-52

Fire Adapters & Connections... I-53 to I-61

Siamese connections	I-53 to I-55
Reversible concealed angle Siamese body	I-56
Concealed 2-way wall hydrant body	I-57
Snoots	I-58, I-59
Wall plates	I-59
Double clapper concealed Siamese assemblies	I-60
2-way sidewalk Siamese assembly	I-60
Single inlet connections	I-61
Single hydrant connections	I-61
Exposed 2-way wall hydrant	I-61

Sanitary Valves

2-way, 3 piece ball valves	I-62 to I-63
Butterfly valves	I-64 to I-67
Clamp end	I-64 to I-66
Automation	I-67
Spring check valves	I-68

Sanitary Valves, cont..... I-62 to I-73

Y ball check valves	I-69
Air blow check	I-70
Tank vent valve.....	I-71 to I-72
3A Sample Valves.....	I-73

Actuation: Electric..... I-74 to I-78

2-piece stainless ball valves	I-74
3-piece stainless ball valves	I-75
Brass ball valves.....	I-76
3-way ball valves T / L port	I-77 to I-78

Actuation: Pneumatic I-79 to I-86

2-piece stainless ball valves	I-79
3-piece stainless ball valves	I-80
Brass ball valves.....	I-81
3-way ball valves T / L port	I-82 to I-83
Wafer butterfly valves	I-84
Lug butterfly valves.....	I-85
Accessories	I-86
Limit switches.....	I-86
Solenoids	I-86
Positioners	I-86

Drum Valves..... I-87 to I-88

Wrenches	I-87
Faucets.....	I-87
Thread adapters	I-88
Gate valves.....	I-88



Domestic Bronze Ball Valves

Valves



Application:

- for control of air, water, oil and gas in hose or pipe lines, for other services, please contact Dixon®

Features:

- pressure rating: **600 PSI** WOG; **150 PSI** saturated steam
- bronze valve bodies, balls and stems
- blow-out proof stems
- glass-filled reinforced PTFE seats and stuffing box ring; stem seals and washers
- plated steel handles and nuts with vinyl sleeves replacements available, contact Dixon® for pricing
- full and standard port valves are repairable
- meets WW-V 35C, Type II Composition

Female NPT	Port	Bronze	
		Part #	Price/E
1/4"	full	BBV25	\$36.00
3/8"	full	BBV38	36.00
1/2"	full	BBV50	36.00
3/4"	standard	BBV75	59.30
1"	standard	BBV100	74.80
1 1/4"	standard	BBV125	125.40
1 1/2"	standard	BBV150	160.25
2"	standard	BBV200	200.75
2 1/2"	standard	BBV250	990.00
3"	standard	BBV300	1160.00

Domestic Bronze Ball Valves

Features:

- machined solid chrome-plated ball
- multi-fill RPTFE seats and seals
- adjustable packing
- blow-out proof stem design
- bronze castings
- vacuum service to 29 inches Hg
- pressure rating: **600 PSI** WOG; **150 PSI** saturated steam



Female NPT	Port	Bronze	
		Part #	Price/E
3/4"	full	BBV75FP	\$55.75
1"	full	BBV100FP	70.55
1 1/4"	full	BBV125FP	164.50
1 1/2"	full	BBV150FP	218.15
2"	full	BBV200FP	375.85

Locking Handle Bronze Ball Valves

Application:

- for control of air, water, oil and gas in hose or pipe lines, for other services, please contact Dixon®

Features:

- pressure rating: **600 PSI WOG**; **150 PSI** saturated steam
- blow-out proof RPTFE stem
- chrome-plated bronze ball
- Stainless steel sliding lock mechanism secures handle in open or closed position; can be padlocked opened or closed.
- plated steel handles and nuts with vinyl sleeves
- full and standard port valves are repairable

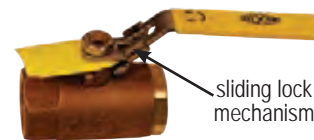

Female NPT	Port	Bronze	
		Part #	Price/E
1/4"	full	BBLV25	\$47.25
3/8"	full	BBLV38	47.25
1/2"	full	BBLV50	47.25
3/4"	standard	BBLV75	70.40
1"	standard	BBLV100	85.90
1 1/4"	standard	BBLV125	136.50
1 1/2"	standard	BBLV150	171.25
2"	standard	BBLV200	211.75

Bronze Ball Valves

Applications:

- for air, water, oil and gas service

Features:

- pressure rating: **600 PSI**, cold non-shock pressure rating: **150 PSI** saturated steam
- chromium plated ball
- RTFE seats and stuffing box ring
- blow-out proof stem
- adjustable packing gland



Male NPT x Female NPT	Port	Bronze	
		Part #	Price/E
1/2"	full	BMV50	\$44.20
3/4"	standard	BMV75	70.35
1"	standard	BMV100	100.40

"Deadman" Spring Return Handle Brass Ball Valves

Features:

- pressure rating: **600 PSI WOG**; **150 PSI** saturated steam
- vacuum service to 29 inches Hg
- stainless steel lever
- chromium plated ball
- RTFE seats and stuffing box ring
- blow-out proof stem design
- adjustable packing gland
- spring return closes valve when not held open
- operating torque approximately three times standard valve torque



Female NPT	Port	Brass	
		Part #	Price/E
1/2"	full	BBV50SR	\$264.25
3/4"	standard	BBV75SR	305.25
1"	standard	BBV100SR	316.30
1 1/2"	standard	BBV150SR	505.00
2"	standard	BBV200SR	595.00

250 Lb. Steam Ball Valves

Valves



Application:

- recommended for use with fluids with widely varying temperatures and/or thermal expansion rates

Features:

- pressure rating: **600 PSI; 250 PSI** saturated steam
- vacuum service to 29 inches Hg
- bronze body
- 316 stainless steel ball and stem
- blow-out proof stem design
- multi-fill RPTFE seats
- multi-fill stuffing box ring
- high temperature MTFE stem packing
- adjustable packing gland
- maximum temperature: **450°F (232°C)**

Female NPT	Port	Bronze	
		Part #	Price/E
1/2"	full	BBV50ST	\$81.35
3/4"	standard	BBV75ST	129.15
1"	standard	BBV100ST	155.00
2"	standard	BBV200ST	430.00

Safety Vented Ball Valves

Application:

- for air service only

Features:

- pressure rating: **0-125 PSI**
- vent downstream air in accordance with OSHA regulation 1910.147 for pneumatic systems
- bronze valve
- chromium plated ball
- RTFE seats and stuffing box ring
- blow-out proof stem design
- adjustable packing gland



sliding lock mechanism

Female NPT	Port	Bronze	
		Part #	Price/E
1/4"	full	BBV25LV	\$52.90
3/8"	full	BBV38LV	52.90
1/2"	full	BBV50LV	52.90
3/4"	standard	BBV75LV	76.25
1"	standard	BBV100LV	97.40
1 1/4"	standard	BBV125LV	154.00
1 1/2"	standard	BBV150LV	188.80
2"	standard	BBV200LV	229.25

Bronze Ball Valves with NPT Tap for Drain

Applications:

- recommended for water and air service

Features:

- pressure rating: **125 PSI** WOG
- vent downstream air in accordance with OSHA regulations for pneumatic systems
- chromium plated ball
- RTFE seats and stuffing box ring
- blow-out proof stem
- adjustable packing gland
- auto-drain / auto-vent
- 1/4" NPT tapped port provides additional options such as an air venting elbow or noise muffler



Female NPT	Port	Bronze	
		Part #	Price/E
1/4"	full	BBV25VT	\$58.00
3/8"	full	BBV38VT	58.00
1/2"	full	BBV50VT	57.00
3/4"	full	BBV75VT	115.50
1"	full	BBV100VT	165.00

Imported Brass Ball Valves

Applications:

- for control of air, water, oil and gas in hose or pipe lines, for other services please contact Dixon®

Features:

- pressure rating: **600 PSI WOG**; **150 PSI** Working Steam Pressure
- forged brass body
- blow-out proof stems
- PTFE seat, seal and thrust washer
- chrome-plated brass ball and plated steel handle
- maximum temperature: **366°F (186°C)**
- Underwriters Listed

female NPT x female NPT



Size	Port	Brass	
		Part #	Price/E
1/4"	full	FBV25	\$18.30
3/8"	full	FBV38	18.90
1/2"	full	FBV50	22.25
3/4"	full	FBV75	31.70
1"	full	FBV100	47.15
1 1/4"	full	FBV125	82.10
1 1/2"	full	FBV150	121.45
2"	full	FBV200	172.20



female NPT x female NPT



Size	Port	Brass	
		Part #	Price/E
2 1/2"	full	FBV250	\$379.55
3"	full	FBV300	543.20
4"	full	FBV400	897.60

Locking Handle Imported Brass Ball Valves

Applications:

- for control of air, water, oil and gas in hose or pipe lines, for other services please contact Dixon®

Features:

- pressure ratings: **600 PSI WOG**; **150 PSI** Working Steam Pressure
- forged brass body
- blow-out proof stem
- PTFE seat, seal and thrust washer
- chrome-plated brass ball and plated steel handle
- maximum temperature: **366°F (186°C)**

Female NPT	Port	Brass	
		Part #	Price/E
1/2"	full	FBVL50	\$36.00
3/4"	full	FBVL75	47.00
1"	full	FBVL100	64.50
1 1/4"	full	FBVL125	106.70
1 1/2"	full	FBVL150	150.50
2"	full	FBVL200	205.90
2 1/2"	full	FBVL250	446.25
3"	full	FBVL300	654.40
4"	full	FBVL400	1084.50



Global Brass Ball Valves

Valves



Applications:

- for water and air only

Features:

- pressure ratings:
 - ¼" - ¾" rated to **365 PSI**
 - ½" - 2" rated to **600 PSI**
- forged brass body
- maximum temperature: **248°F (120°C)**

Female NPT	Port	Forged Brass	
		Part #	Price/E
¼"	full	FBVG25	\$7.50
⅜"	full	FBVG38	7.50
½"	full	FBVG50	11.80
¾"	full	FBVG75	16.60
1"	full	FBVG100	27.25
1¼"	full	FBVG125	42.00
1½"	full	FBVG150	59.00
2"	full	FBVG200	90.00

Solder End Brass Ball Valves

Applications:

- provides protection against potential gas leakage under extreme duty or low pressure applications

Features:

- pressure rating: **600 PSI WOG; 150 PSI** working steam pressure
- maximum temperature: **366°F (186°C)**
- brass body
- blow-out proof stem
- chrome-plated brass ball
- adjustable stem packing nut
- PTFE seat, seal, and thrust washer



Size	Port	Brass	
		Part #	Price/E
½"	full	FBV50SE	\$23.95
¾"	full	FBV75SE	32.65
1"	full	FBV100SE	48.15
1¼"	full	FBV125SE	86.80
1½"	full	FBV150SE	125.55
2"	full	FBV200SE	178.15

Lead Free Brass Ball Valves

Features:

- lead free refers to the wetted surface of pipes, fittings and fixtures in potable water systems that have a weighted average lead content = 0.25% Source: California Health & Safety Code (116875). Vermont Act 193*171NLF
- pressure rating: **600 WOG - 150 WSP**
- maximum temperature: **366°F (186°C)**
- PTFE seat and double O-ring stem packing



Female NPT	Port	Lead Free Brass	
		Part #	Price/E
½"	full	LFV50	\$26.75
¾"	full	LFV75	38.00
1"	full	LFV100	57.00
1¼"	full	LFV125	99.00
1½"	full	LFV150	146.00
2"	full	LFV200	214.00

Dual Y Valves

Application:

- ideal for compressor applications

Features:

- dual action valve
- non-vented pressure rating: **600 PSI WOG**
- vented pressure rating: **125 PSI** Cold Working Pressure

Vented

Female NPT Inlet (1)	Female NPT Outlets (2)	Bronze	
		Part #	Price/E
1"	3/4"	BBV100DWV	\$168.00
1 1/4"	3/4"	BBV125DWV	168.00

Non-Vented

Female NPT Inlet (1)	Female NPT Outlets (2)	Bronze	
		Part #	Price/E
1"	3/4"	BBV100DW	\$168.00
1 1/4"	3/4"	BBV125DW	168.00



Valves

Mini Ball Valves



Features:

- pressure rating: **450 PSI**
- nickel plated brass body
- PTFE seats and FKM stem seal
- blow-out proof stem
- maximum temperature **330°F (166°C)**
- Canadian Standard Association approved

Female NPT	Port	Nickel Plated Brass	
		Part #	Price/E
1/8"	standard	MBV12	\$13.40
1/4"	standard	MBV25	13.40
3/8"	standard	MBV38	12.45
1/2"	standard	MBV50	18.30



3-Way Brass Diverting Ball Valves T Flow

female NPT x female NPT x female NPT

Valves



Features:

- pressure rating: **400 PSI WOG**; **100 PSI** saturated steam
- brass body
- blow-out proof stem
- chrome plated brass ball
- PTFE seats, seals, and thrust washer
- adjustable stem packing
- maximum temperature: **366°F (186°C)**

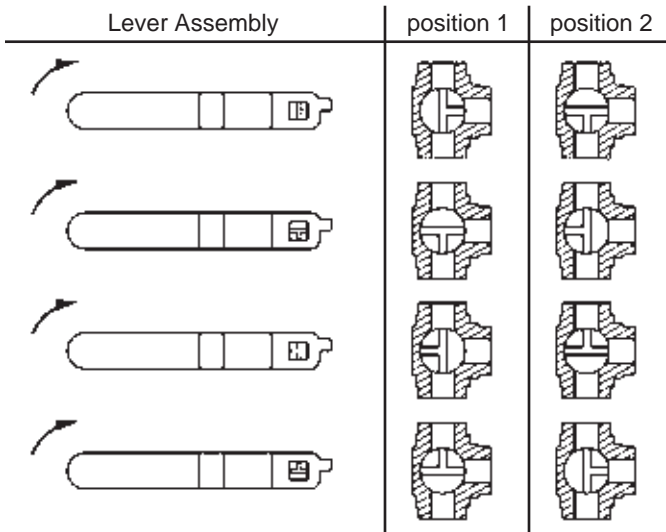

Size	Port	Brass	
		Part #	Price/E
1/2"	standard	BBV50DTW	\$108.50
3/4"	standard	BBV75DTW	119.80
1"	standard	BBV100DTW	183.65
1 1/4"	standard	BBV125DTW	269.10
1 1/2"	standard	BBV150DTW	409.35
2"	standard	BBV200DTW	668.55

Note: 1/4 turn handle can be adjusted to any orientation.
Notches on the valve stem reflect the three openings on the ball.

3-Way Brass Diverting Ball Valves L Flow

female NPT x female NPT x female NPT



Features:

- can be used with gasoline and diesel fuel
- pressure rating: **400 PSI WOG**
- bronze body
- blow-out proof stem
- chromium-plated ball
- RPTFE seats and stuffing box ring
- stainless steel handle and nut with vinyl sleeve
- adjustable packing gland

Size	Port	Bronze	
		Part #	Price/E
1/2"	full	BBV50TW¹	\$72.90
3/4"	standard	BBV75TW	100.75
1"	standard	BBV100TW	133.50

¹ carbon steel handle and nut with vinyl sleeve

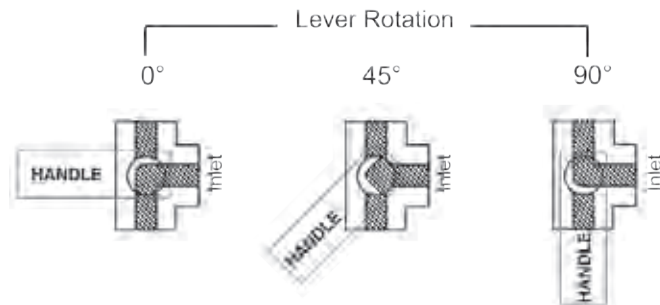

Features:

- rated to **800 PSI WOG**
- stainless steel body and ball
- blow-out proof stem
- RPTFE seats and stuffing box ring
- stainless steel handle and nut with vinyl sleeve
- adjustable packing gland
- meets NACE MR-01-75

Size	Port	Stainless Steel	
		Part #	Price/E
1/2"	full	SSBV50TW	\$302.00
3/4"	standard	SSBV75TW	400.00
1"	standard	SSBV100TW	503.00

2-Piece Domestic Stainless Steel Ball Valves

Features:

- pressure rating: **1,000 PSI** Cold Working Pressure
- pressure rating: **150 PSI** saturated steam
- vacuum service to 29 inches Hg
- 316 stainless body, ball and stem
- PTFE seal
- blow-out proof stem
- vinyl handle cover
- temperature range: **-40°F to 400°F (-40°C to 204°C)**

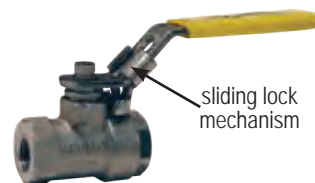

Female NPT	Port	316 Stainless Steel	
		Part #	Price/E
1/4"	full	DSBV25	\$100.70
3/8"	full	DSBV38	100.70
1/2"	full	DSBV50	105.50
3/4"	full	DSBV75	138.50
1"	full	DSBV100	195.05
1 1/4"	full	DSBV125	246.95
1 1/2"	full	DSBV150	386.75
2"	full	DSBV200	481.05

Stainless Steel Ball Valves Full Port

Applications:

- for use with water, oil and gas

Features:

- pressure rating: 1/4" - 2" rated to **1000 PSI** WOG (CWP)
2 1/2" - 3" rated to **800 PSI** WOG (CWP)
100 PSI saturated steam
- 316 stainless steel body, ball and stem
- R-PTFE seat, joint gasket and thrust washer
- plastic cover on handle
- blow-out proof stem design
- temperature range: **-20°F to 356°F (-29°C to 180°C)**
- not recommended as a throttling valve



Female NPT	Port	316 Stainless Steel	
		Part #	Price/E
1/4"	full	SSBV25	\$39.50
3/8"	full	SSBV38	42.00
1/2"	full	SSBV50	44.00
3/4"	full	SSBV75	63.00
1"	full	SSBV100	84.00
1 1/4"	full	SSBV125	121.00
1 1/2"	full	SSBV150	166.00
2"	full	SSBV200	232.00
2 1/2"	full	SSBV250	495.00
3"	full	SSBV300	690.00

Stainless Steel Ball Valves Full Port, Locking Handle

Applications:

- for use with water, oil and gas

Features:

- pressure rating: ¼" - 2" rated to **1000 PSI** WOG (CWP)
2½" - 3" rated to **800 PSI** WOG (CWP)
100 PSI saturated steam
- 316 stainless steel body, ball and stem
- R-PTFE seat, joint gasket and thrust washer
- plastic cover on handle
- blow-out proof stem design
- temperature range: **-20°F to 356°F (-29°C to 180°C)**
- lockable
- not recommended as a throttling valve



Female NPT	Port	316 Stainless Steel	
		Part #	Price/E
¼"	full	SSLBV25	\$43.00
⅜"	full	SSLBV38	44.00
½"	full	SSLBV50	48.00
¾"	full	SSLBV75	70.00
1"	full	SSLBV100	90.00
1¼"	full	SSLBV125	129.00
1½"	full	SSLBV150	171.00
2"	full	SSLBV200	236.00
2½"	full	SSLBV250	510.00
3"	full	SSLBV300	750.00

Stainless Steel Ball Valves Reduced Port, Locking Handle

Applications:

- for use with water, oil and gas

Features:

- pressure rating: **1000 PSI** WOG; **100 PSI** saturated steam
- 316 stainless steel body, ball and stem
- R-PTFE seat, joint gasket and thrust washer
- plastic cover on handle
- blow-out proof stem design
- temperature range: **-20°F to 356°F (-29°C to 180°C)**
- lockable
- not recommended as a throttling valve



Female NPT	Port	316 Stainless Steel	
		Part #	Price/E
¼"	reduced	SSLBV25SP	\$28.50
⅜"	reduced	SSLBV38SP	30.50
½"	reduced	SSLBV50SP	32.50
¾"	reduced	SSLBV75SP	44.00
1"	reduced	SSLBV100SP	63.00
1¼"	reduced	SSLBV125SP	84.00
1½"	reduced	SSLBV150SP	115.00
2"	reduced	SSLBV200SP	162.00

3-Piece Industrial Stainless Steel Ball Valves FNPT

Features:

- blow out proof stem
- live-loaded stem packing
- swing out design for easy maintenance
- ISO 5211 mounting pad
- RTFE seat and seals
- maximum temperature: **400°F (200°C)**

Female NPT	Port	PSI @ 65°F	Body Length	CF8M Stainless Steel	
				Part #	Price/E
½"	full	1000	2.5"	BV2IG-05011-A	\$107.48
¾"	full	1000	3.1"	BV2IG-07511-A	134.60
1"	full	1000	3.3"	BV2IG-10011-A	175.56
1¼"	full	1000	4.1"	BV2IG-12511-A	233.15
1½"	full	1000	4.4"	BV2IG-15011-A	319.09
2"	full	1000	5.1"	BV2IG-20011-A	454.59
2½"	full	800	6.6"	BV2IG-25011-A	1065.64
3"	full	800	7.3"	BV2IG-30011-A	1290.29
4"	full	600	8.9"	BV2IG-40011-A	2273.86



Valves

3-Piece Industrial Stainless Steel Ball Valves Socket Weld

Female NPT	Port	PSI @ 65°F	Body Length	CF8M Stainless Steel	
				Part #	Price/E
½"	full	1000	2.5"	BV2IG-05033-A	\$100.59
¾"	full	1000	3.1"	BV2IG-07533-A	132.23
1"	full	1000	3.3"	BV2IG-10033-A	173.66
1¼"	full	1000	4.1"	BV2IG-12533-A	240.99
1½"	full	1000	4.4"	BV2IG-15033-A	343.61
2"	full	1000	5.1"	BV2IG-20033-A	454.59
2½"	full	800	6.6"	BV2IG-25033-A	908.85
3"	full	800	7.3"	BV2IG-30033-A	1290.29
4"	full	600	8.9"	BV2IG-40033-A	2273.86



"Deadman" Spring Return Handle Stainless Steel Ball Valves

Features:

- pressure rating: **2000 PSI WOG ½" to 1"**; **1500 PSI WOG 1¼" to 2"**
- **150 PSI** saturated steam, all sizes
- vacuum service to 29 inches Hg, all sizes
- PTFE seal
- blow-out proof stem design
- adjustable packing gland
- spring return closes valve when not held open
- operating torque approximately three times standard valve torque

Female NPT	Port	316 Stainless Steel	
		Part #	Price/E
½"	full	SSBV50SR	\$280.20
¾"	standard	SSBV75SR	362.75
1"	standard	SSBV100SR	407.70
1¼"	standard	SSBV125SR	663.90
1½"	standard	SSBV150SR	716.50
2"	standard	SSBV200SR	888.75



Industrial Wafer Ball Valves

Valves



Features:

- ANSI Class 150 wafer style ball valve
- full port, sizes 1" to 4"
- blow out proof stem
- ideal option to high performance butterflies
- space saving, anti-static stem design
- locking plate included

Materials:

- body – CF8M
- ball and end connection – 316 stainless steel
- elastomers – FKM
- stem seal – PTFE

Size	Stainless Steel	
	Part #	Price/E
1"	BV2IC-100WW-A	\$565.83
1¼"	BV2IC-125WW-A	645.26
1½"	BV2IC-150WW-A	734.10
2"	BV2IC-200WW-A	914.17
2½"	BV2IC-250WW-A	1458.97
3"	BV2IC-300WW-A	1982.69
4"	BV2IC-400WW-A	2936.60

Mann Tek Full Flow Ball Valves

Features:

- high flow rate; low pressure drop
- wetted parts are aluminum and stainless steel
- FPM seals
- spindle can be disassembled even when ball valve is installed
- working pressure: **150 PSI** at ambient temperature **70°F (21°C)**
- standard valve ports - female NPT, socket weld for Schedule 40 pipe and grooved
- optional ports include DN flange, butt weld and 150# flange, contact Dixon® for details
- two ports - one inlet and one outlet



One-Way Full Flow Ball Valve Female NPT

Size	Aluminum	
	Part #	Price/E
2"	1WAYBV200	\$631.75
3"	1WAYBV300	842.35
4"	1WAYBV400	1223.75

One-Way Full Flow Ball Valve Socket Weld



Size	Bore	Aluminum	
		Part #	Price/E
2"	2.390"	1WAYBV200SW	\$651.30
3"	3.530"	1WAYBV300SW	842.35

One-Way Full Flow Ball Valve Grooved



Size	Aluminum	
	Part #	Price/E
2"	1WAYBV200VIC	\$861.10
3"	1WAYBV300VIC	1146.35

Mann Tek Full Flow Ball Valves

Features:

- high flow rate; low pressure drop
- wetted parts are aluminum and stainless steel
- FPM seals
- spindle can be disassembled even when ball valve is installed
- working pressure: **150 PSI** at ambient temperature **70°F (21°C)**
- standard valve ports - female NPT, socket weld for Schedule 40 pipe and grooved
- optional ports include DN flange, butt weld and 150# flange, contact Dixon® for details
- three ports - one inlet and two outlets, valve directs the flow from the inlet to either of the two outlets
- commonly used for switching compartments or tanks



Valves

Two-Way Full Flow Ball Valve Female NPT

Size	Aluminum	
	Part #	Price/E
2"	2WAYBV200	\$786.20
3"	2WAYBV300	1135.20
4"	2WAYBV400	2467.05

Two-Way Full Flow Ball Valve Socket Weld

Size	Bore	Aluminum	
		Part #	Price/E
2"	2.390"	2WAYBV200SW	\$786.20
3"	3.530"	2WAYBV300SW	1135.20



Two-Way Full Flow Ball Valve Grooved

Size	Aluminum	
	Part #	Price/E
2"	2WAYBV200VIC3	\$945.50
3"	2WAYBV300VIC3	2049.55



Carbon Steel Ball Valves

Valves



Applications:

- for control of air, water, oil and gas in hose or pipe lines, for other services please contact Dixon®

Features:

- pressure rating: **150 PSI** saturated steam
- carbon steel body
- chromium plated ball
- RPTFE seat and seal
- blow-out proof stem
- adjustable packing gland

Female NPT	PSI	Port	Carbon Steel	
			Part #	Price/E
1/4"	2000	full	IBV25	\$64.00
3/8"	2000	full	IBV38	64.00
1/2"	2000	standard	IBV50	64.00
3/4"	2000	standard	IBV75	74.00
1"	2000	standard	IBV100	98.50
1 1/4"	1500	standard	IBV125	150.00
1 1/2"	1500	standard	IBV150	208.00
2"	1500	standard	IBV200	270.00

High Pressure Full-Bore Ball Valves

Features:

- blow-out proof stem
- rugged construction
- FKM/FPM seals
- POM (Polyacetal) ball seats



Female NPT	PSI	Carbon Steel				PSI	316 Stainless Steel	
		Part #	Price/E	SAE Part #	Price/E		Part #	Price/E
1/4"	7350	HPBV25	\$63.90	HPBV25SAE	\$71.65	5880	HPBV25SS	\$427.50
3/8"	7350	HPBV38	67.80	HPBV38SAE	80.70	5880	HPBV38SS	497.50
1/2"	7350	HPBV12	73.70	HPBV12SAE	87.10	5880	HPBV12SS	595.00
3/4"	6000	HPBV34	145.05	HPBV34SAE	162.20	5145	HPBV34SS	1027.90
1"	6000	HPBV10	173.10	HPBV10SAE	190.00	5145	HPBV10SS	1212.80
1 1/4"	6000	HPBV125	452.90	HPBV125SAE	490.20	---	---	---
1 1/2"	6000	HPBV150	548.90	HPBV150SAE	583.00	---	---	---
2"	6000	HPBV200	831.00	HPBV200SAE	870.00	---	---	---

High Pressure Full-Bore 3-Way Ball Valves

Features:

- temperature range: **-20°F to 215° F (-29°C to 102°C)**
- rugged construction
- FKM seals
- POM (polyacetal) ball seats
- black oxide coating
- nickel plated ball



Standard L 90°

Female NPT	PSI	Carbon Steel	
		Part #	Price/E
1/2"	5145	HPBV12-3WAY	\$163.00
3/4"	5145	HPBV34-3WAY	204.00
1"	5145	HPBV10-3WAY	218.00

150# Flanged Ball Valves

Applications:

- suitable for air, water, oil and gas

Features:

- product approvals include: LP gas shut-off valves, flammable liquid shut-off valves, gas shut-off valves, compressed gas shut-off valves, and anhydrous ammonia shut-off valves
- body: ASTM A216 WCB
- RPTFE seat
- vacuum service to 29 inches of Hg
- pressure rating: **150 PSIG** saturated steam
- temperature up to **400°F (204°C)**
- PSI rating up to **280 PSI**
- four point ISO 5211 mounting pad bolt pattern
- anti-static grounded ball and stem
- blow-out proof stem design
- bleed/drain port (cast) 1/2" NPT
- fire safe (graphite packing and seal)
- adjustable packing gland



Size	Port	Carbon Steel	
		Part #	Price/E
2"	full	FLBV200CS	\$1260.00
2½"	full	FLBV250CS	2125.00
3"	full	FLBV300CS	2205.00
4"	full	FLBV400CS	3370.00
6"	full	FLBV600CS	7642.00
8"	full	FLBV800CS	15526.00

- For flange dimensions, diagrams and additional information please reference dixonvalve.com.

Polypropylene Bolted Ball Valves

Features:

- pressure rating: ½" - 3" is rated to **125 PSI at 70°F (21°C)**
4" is rated to **90 PSI at 70°F (21°C)**
- chemically-resistant, reinforced polypropylene
- PTFE ball seat
- EPDM O-ring body seal, FKM O-ring stem seal
- 304 stainless steel nuts and bolts
- FDA approved material

Polypropylene 4-Bolt Ball Valves

Female NPT	Port	Polypropylene	
		Part #	Price/E
½"	full	PVFP50	\$48.50
¾"	full	PVFP75	48.50
1"	full	PVFP100	56.50
1½"	full	PVFP150	72.25
1"	standard	PV100	48.50
2"	standard	PV200	70.00



Polypropylene 6-Bolt Ball Valves

Female NPT	Port	Polypropylene	
		Part #	Price/E
2"	full	PVFP200	\$102.00
3"	full	PVFP300	246.75
4"	full	PVFP400	520.00



Polypropylene Compact Bolted Ball Valves

Features:

- pressure rating: **125 PSI at 70°F (21°C)**
- chemically-resistant, reinforced polypropylene body, PTFE ball seat
- EPDM O-ring body seal, FKM O-ring stem seals
- 304 stainless steel nuts and bolts
- FDA approved material



Polypropylene Compact Bolted Ball Valve

Female NPT	Port	Body Length	Polypropylene	
			Part #	Price/E
2"	full	4 ⁷ / ₈ "	PVFPS200	\$80.75



Polypropylene Compact Bolted Ball Valve

Female NPT x Male Adaptor	Port	Body Length	Polypropylene	
			Part #	Price/E
2"	full	6 ⁷ / ₈ "	PVFPSA200	\$80.75

Polypropylene 45° Single Union Nozzle Valves

Features:

- pressure rating: **125 PSI at 70°F (21°C)**
- corrosion resistant polypropylene body, PTFE ball seats
- EPDM O-ring
- FDA approved material



Female NPT x Nozzle	Port	Polypropylene	
		Part #	Price/E
1"	full	SUBVN100	\$30.00

Polypropylene Bolted Ball Valves with Nozzle

Features:

- pressure rating: **125 PSI at 70°F (21°C)**
- chemically-resistant, reinforced polypropylene body, PTFE ball seat
- EPDM O-ring body seals, FKM O-ring stem seals
- 304 stainless steel nuts and bolts
- FDA approved material
- body-to-flange design allows for low torque operation



Female NPT x Nozzle	Port	Polypropylene	
		Part #	Price/E
1 ¹ / ₂ "	full	PVFPN150	\$98.75
2"	full	PVFPN200	142.50
2"	standard	PVN200	101.75

Polypropylene Single Union Ball Valves

Features:

- pressure rating: **125 PSI at 70°F (21°C)**
- corrosion resistant polypropylene body, PTFE ball seat
- EPDM O-ring
- FDA approved material



Female NPT	Port	Polypropylene	
		Part #	Price/E
1/2"	full	SUBV50	\$20.50
3/4"	full	SUBV75	22.60
1"	full	SUBV100	28.75
1 ¹ / ₄ "	full	SUBV125	47.25
1 ¹ / ₂ "	full	SUBV150	58.50
2"	full	SUBV200	74.50
3"	full	SUBV300	221.50

Domestic Bronze Gate Valves

Features:

- Class 150
- pressure rating: **300 PSI** cold working pressure, **150 PSI** steam working pressure
- union bonnet
- ASME B1.20.1
- Grafoil® packing
- rising stem
- solid disc
- malleable iron handwheel
- 100% factory tested
- temperature range: **-20°F to 406°F (-29°C to 208°C)**

Female NPT	Bronze	
	Part #	Price/E
1/2"	DBGV50	\$125.25
3/4"	DBGV75	148.75
1"	DBGV100	187.90
1 1/4"	DBGV125	289.75
1 1/2"	DBGV150	356.95
2"	DBGV200	433.70



Valves

Gate Valves

Features:

- pressure rating: **200 PSI** non-shock cold water, oil, gas
- threaded bonnet
- integral seat
- adjustable packing nut
- non-rising stem
- solid wedge disc
- iron handwheel
- 100% factory tested

Female NPT	Brass		316 Stainless Steel	
	Part #	Price/E	Part #	Price/E
1/4"	BGV25	\$17.70	---	---
3/8"	BGV38	17.70	---	---
1/2"	BGV50	17.70	SSGV50	\$136.75
3/4"	BGV75	24.30	SSGV75	162.75
1"	BGV100	36.45	SSGV100	204.00
1 1/4"	BGV125	51.90	SSGV125	279.10
1 1/2"	BGV150	66.10	SSGV150	371.50
2"	BGV200	97.95	SSGV200	458.30
2 1/2"	BGV250	186.85	---	---
3"	BGV300	255.75	---	---
4"	BGV400	400.05	---	---



brass



316 stainless

Forged Steel Gate Valves

Application:

- can be used for steam service

Features:

- Class 800
- ASTM A105, ANSI B120.1
- bolted bonnet
- pressure rating: **1975 PSI**
- maximum temperature: **800°F (427°C)**

Female NPT	Forged Steel	
	Part #	Price/E
1/2"	FSGV50	\$114.35
3/4"	FSGV75	120.60
1"	FSGV100	165.55
1 1/4"	FSGV125	300.90
1 1/2"	FSGV150	311.50
2"	FSGV200	395.20



Domestic Bronze Globe Valves

Features:

- Class 150
- pressure rating: **300 PSI** cold working pressure, **150 PSI** steam working pressure
- union bonnet
- ASME B1.20.1
- Grafoil® packing
- PTFE disc
- malleable iron handwheel
- 100% factory tested



Female NPT	Bronze	
	Part #	Price/E
1/2"	DGLBV50	\$172.00
3/4"	DGLBV75	230.00
1"	DGLBV100	360.00
1 1/4"	DGLBV125	573.00
1 1/2"	DGLBV150	696.00
2"	DGLBV200	1044.00

Forged Steel Globe Valves

Features:

- Class 800
- ASTM A105, ANSI B120.1
- bolted bonnet
- pressure rating: **1975 PSI**
- maximum temperature: **800°F (427°C)**
- can be used for steam service



Female NPT	Forged Steel	
	Part #	Price/E
1/2"	FSGLBV50	\$158.80
3/4"	FSGLBV75	172.65
1"	FSGLBV100	229.60
1 1/4"	FSGLBV125	416.00
1 1/2"	FSGLBV150	426.35
2"	FSGLBV200	526.45



Betts Wet-R-Dri™ Butterfly Valves

Application:

- designed for handling liquid, gaseous or dry products

Features:

- has a positive stop in the open and closed position
- detent spring and ball assist in holding the disc in the open and closed position
- drilling fits TTMA recommended standards
- opens by turning hand 1/4 turn counter clockwise
- temperature range: **0°F to 400°F (-17.7°C to 204.4°C)**



Manual

Size	Maximum Working Pressure PSI	Extruded aluminum body with FKM-B disc	
		Part #	Price/E
3"	75	WD301ALVB	\$285.00
4"	75	WD401ALVB	328.00



Metering

Size	Maximum Working Pressure PSI	Extruded aluminum body with FKM-B disc	
		Part #	Price/E
3"	75	WD304ALVB	\$350.00
4"	75	WD404ALVB	394.00

• For flange dimensions, diagrams and additional information please reference dixonvalve.com.

Ductile Iron Butterfly Valves

! NOT RECOMMENDED FOR STEAM SERVICE

- for use between two 150 lb. flanges
- 10 position trigger grip handle
- pressure rating: **200 PSI** at ambient temperature **70°F (21°C)**

Features:

- ductile iron body, ASTM A536
- aluminum bronze disc, ASTM B148, ALY.954
- PTFE bushing
- stainless steel top and bottom stems

Threaded Lug Style Butterfly Valves

Size	Ductile Iron with Buna-N liner		Ductile Iron with EPDM liner	
	Part #	Price/E	Part #	Price/E
2"	BFVL200	\$145.00	BFVL200E	\$145.00
3"	BFVL300	181.25	BFVL300E	181.25
4"	BFVL400	270.00	BFVL400E	270.00
6"	BFVL600	475.00	BFVL600E	475.00



Valves

Wafer Style 150 lb. Butterfly Valves with Aluminum Bronze Disc

Features:

- ductile iron body, ASTM A536
- aluminum bronze disc, ASTM B148, ALY.954
- PTFE bushing
- stainless steel top and bottom stems

Size	Ductile Iron with Buna-N liner		Ductile Iron with EPDM liner	
	Part #	Price/E	Part #	Price/E
2"	BBFVW200	\$133.00	BBFVW200E	\$133.00
3"	BBFVW300	170.00	BBFVW300E	170.00
4"	BBFVW400	240.00	BBFVW400E	240.00
6"	BBFVW600	420.00	BBFVW600E	420.00



Wafer Style 150 lb. Butterfly Valves with Stainless Disc

Features:

- ductile iron body, ASTM A536
- stainless steel disc, ASTM A351, GR. CF-8M
- Buna-N seal and stem seals
- PTFE bushing
- stainless steel top and bottom stems

Size	Ductile Iron with Buna-N liner	
	Part #	Price/E
2"	BFVW200	\$150.00
3"	BFVW300	185.00
4"	BFVW400	250.00
6"	BFVW600	527.85



Wafer Style 150 lb. Butterfly Valves with Iron Disc

Features:

- ductile iron body, ASTM A536
- nickel plated ductile iron disc
- Buna-N seal and stem seals
- PTFE bushing
- 416 stainless stem

Size	Ductile Iron with Buna-N liner		Ductile Iron with EPDM liner	
	Part #	Price/E	Part #	Price/E
2"	IBFVW300	\$106.40	IBFVW300E	\$106.40
3"	IBFVW400	140.00	IBFVW400E	140.00
4"	IBFVW600	191.00	IBFVW600E	191.00
6"	IBFVW800	308.00	IBFVW800E	308.00



Steel Series F Flow Control Valves

Features:

- Two-step needle provides fine adjustments at low flow with the first three turns of the adjusting knob. The next three turns give full-open needle position and conventional throttling control. When flow is reversed, a heavy-duty poppet/retainer permits full-flow return capacity.
- color-coded reference scale simplifies flow setting, resetting, adjusting and return to original flow, a simple set screw locks the valve on any desired setting.
- maximum operating pressure: **5000 PSI at 70°F (21°C)** for 1/8" - 1/2", **3000 PSI at 70°F (21°C)** for 3/4" - 2"



Female NPTF	Black Oxide Steel	
	Part #	Price/E
1/8"	SFC200	\$80.45
1/4"	SFC400	84.30
3/8"	SFC600	105.55
1/2"	SFC800	142.20
3/4"	SFC1200	202.55
1"	SFC1600	599.10
1 1/2"	SFC2400	2032.60
2"	SFC3200	4029.05

Brass Series F Flow Control Valves

Features:

- provides precision flow control and full shutoff in one flow direction, automatically allows unrestricted flow in the opposite direction
- two-step needle for fine adjustments at low flow with first 3 turns of the adjusting knob, next 3 turns give full-open needle position and conventional throttling control
- when flow is reversed the heavy-duty poppet/retainer permits full flow return capacity
- color coded scale simplifies flow setting, resetting, adjusting and return to an original flow
- a set screw locks the valve on any desired setting
- maximum operating pressure: **2000 PSI** at ambient temperature **70°F (21°C)** for sizes 1/8" - 3/4", **500 PSI** at ambient temperature **70°F (21°C)** for 1"



Female NPTF	Brass	
	Part #	Price/E
1/8"	BFC200	\$97.75
1/4"	BFC400	104.35
3/8"	BFC600	135.60
1/2"	BFC800	191.85
3/4"	BFC1200	327.50
1"	BFC1600	1340.50

Series MV Metering Flow Control Valves

Features:

- easily make fine adjustments and resets with color code feature that shows when desired setting is reached
- body components are precision-turned from solid barstock
- 416 stainless steel needle
- maximum operating pressure: **5000 PSI at 70°F (21°C)**



Female NPTF	Steel	
	Part #	Price/E
1/4"	SMV400	\$94.35
3/8"	SMV600	180.40
1/2"	SMV800	224.95

Steel Series PF Flow Control Valves

Features:

- recommended for use in non-shock applications
- ball type check meters the flow of hydraulic oil in one direction and allows for free flow in the reverse direction
- maximum operating pressure: **5000 PSI at 70°F (21°C)**, cracking pressure: **5 PSI**

Female NPTF	Zinc Plated Steel with a dichromate seal	
	Part #	Price/E
1/4"	SPF400	\$66.20
3/8"	SPF600	88.10
1/2"	SPF800	110.70



Brass Series PF Flow Control Valves

Features:

- ball type check meters flow of air in one direction and allows free flow in the reverse direction
- used to control actuator speed by acting as a restriction
- maximum operating pressure: **2000 PSI at ambient temperature 70°F (21°C)**
- cracking pressure: **5 PSI**

Female NPTF	Brass	
	Part #	Price/E
1/8"	BPF200	\$69.10
1/4"	BPF400	84.15
3/8"	BPF600	110.00
1/2"	BPF800	150.80



Steel Series N Flow Control Valves

Features:

- excellent speed control on hydraulic systems where a reverse flow check valve is not needed
- reliable shutoff in a very small envelope; color-coded reference scale simplifies setting, resetting, adjusting and quick return to a previous speed setting
- maximum operating pressure: **5000 PSI at 70°F (21°C)** for 1/8" - 3/4", **3000 PSI at 70°F (21°C)** for 1" - 1 1/4"

Female NPTF	Steel	
	Part #	Price/E
1/8"	SN200	\$86.05
1/4"	SN400	86.35
3/8"	SN600	107.20
1/2"	SN800	137.55
3/4"	SN1200	193.55
1"	SN1600	1031.60
1 1/4"	SN2000	1423.75



Brass Series N Flow Control Valves

Features:

- for use as speed control on hydraulic and pneumatic systems where a reverse flow check valve is not needed
- provides excellent control and reliable shutoff in a very small envelope
- color coded scale simplifies setting, resetting, adjusting and quick return to a previous speed setting
- maximum operating pressure: **2000 PSI at ambient temperature 70°F (21°C)** for sizes 1/8" - 3/4", **500 PSI at ambient temperature 70°F (21°C)** for 1"

Female NPTF	Brass	
	Part #	Price/E
1/8"	BN200	\$93.55
1/4"	BN400	96.25
3/8"	BN600	125.60
1/2"	BN800	175.55
3/4"	BN1200	370.90
1"	BN1600	1555.85



Mini Needle Valves

Valves

Features:

- available in a variety of materials and handle options
- FKM O-ring seal and PTFE back-up ring below the threads protects from corrosion and galling
- stem threads are rolled for strength and ease of operation
- metal-to-metal hard seat design is 100% helium leak tested to 1 x 10⁻⁴ ml/s at 200 PSI
- 1/8" and 1/4" are orifice size: 0.172", flow coefficient: 0.42
- 1/2": orifice size are 0.187", flow coefficient: 0.44, hex body
- all stems are 316 stainless steel

Male to Female



NPT Size	Handle Style	PSI @ 200°F	Brass		Handle Style	PSI at 200°F	Zinc Nickel Plated Steel		316 Stainless Steel	
			Part #	Price/E			Part #	Price/E	Part #	Price/E
1/8" - 27	knurled knob	6000	MFB101	\$64.25	T design	10000	MFC101	\$49.20	MFS101	\$111.05
1/4" - 18	knurled knob	6000	MFB102	64.25	T design	10000	MFC102	49.20	MFS102	111.05
1/2" - 14	---	---	---	---	T design	10000	MFC404	69.10	MFS404	172.70

Female to Female



NPT Size	Handle Style	PSI at 200°F	Brass		Handle Style	PSI at 200°F	Zinc Nickel Plated Steel		316 Stainless Steel	
			Part #	Price/E			Part #	Price/E	Part #	Price/E
1/8" - 27	knurled knob	6000	FFB101	\$64.25	T design	10000	FFC101	\$49.20	FFS101	\$111.05
1/4" - 18	knurled knob	6000	FFB102	64.25	T design	10000	FFC102	49.20	FFS102	111.05
1/2" - 14	---	---	---	---	T design	10000	FFC404	69.10	FFS404	163.10

Multiport Needle Valves

Features:

- reduces the number of gauge and other instrument connections to permanent piping installations, decreasing possible leak paths
- FKM O-ring seal and PTFE back-up ring below the threads protects from corrosion and galling
- stem threads are rolled for strength and ease of operation
- metal-to-metal hard seat design is 100% helium leak tested to 1 x 10⁻⁴ ml/s at 200 PSI
- 1/2" female NPT port
- orifice size is 0.187", flow coefficient: 0.44
- all stems are 316 stainless steel

Hard Seat Male to Female



NPT Size	Handle Style	PSI at 200°F	Zinc Nickel Plated Steel		316 Stainless Steel	
			Part #	Price/E	Part #	Price/E
1/2" - 14	T design	10000	MFC204	\$202.25	MFS204	\$411.10
3/4" - 14	T design	10000	MFC20604	202.25	MFS20604	411.10

Soft Seat Male to Female

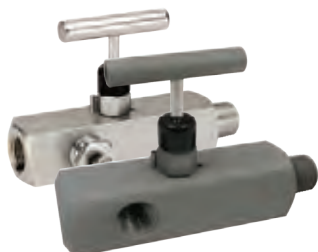

NPT Size	Handle Style	PSI at 200°F	Zinc Nickel Plated Steel		316 Stainless Steel	
			Part #	Price/E	Part #	Price/E
1/2" - 14	T design	6000	MFC304	\$202.25	MFS304	\$411.10
3/4" - 14	T design	6000	MFC30604	202.25	MFS30604	411.10

Block and Bleed Needle Valves

Features:

- allows pressure to be bled off without disturbing the permanent piping installation allowing quick and easy removal or replacement of instruments
- FKM O-ring seal and PTFE back-up ring below the threads protects from corrosion and galling
- stem threads are rolled for strength and ease of operation
- metal-to-metal hard seat design is 100% helium leak tested to 1 x 10⁻⁴ ml/s at 200 PSI
- orifice size is 0.187", flow coefficient: 0.44
- all stems are 316 stainless steel
- 0.090" bleed hole located on bottom is controlled by a ¼"-20 UNF-2A bleed screw

Hard Seat Male to Female

NPT Size	Handle Style	PSI at 200°F	Zinc Nickel Plated Steel		316 Stainless Steel	
			Part #	Price/E	Part #	Price/E
¼" - 18	T design	10000	MFC602	\$126.60	MFS602	\$283.85
½" - 14	T design	10000	MFC604	136.55	MFS604	311.45



Soft Seat Male to Female

NPT Size	Handle Style	PSI at 200°F	Zinc Nickel Plated Steel		316 Stainless Steel	
			Part #	Price/E	Part #	Price/E
¼" - 18	T design	6000	MFC702	\$129.50	MFS702	\$286.10
½" - 14	T design	6000	MFC704	138.95	MFS704	311.70



Bleed Needle Valves

Features:

- convenient way to relieve process pressures trapped between a shut-off valve and the instrument
- FKM O-ring seal and PTFE back-up ring below the threads protects from corrosion and galling
- stem threads are rolled for strength and ease of operation
- metal-to-metal hard seat design is 100% helium leak tested to 1 x 10⁻⁴ ml/s at 200 PSI
- non-rotating soft tip stem and a backup metal-to-metal seal
- all stems are 316 stainless steel
- 0.159" bleed port

Hard Seat Male

NPT Size	Handle Style	PSI at 200°F	Zinc Nickel Plated Steel		316 Stainless Steel	
			Part #	Price/E	Part #	Price/E
¼" - 18	T design	10000	MC802	\$104.60	MS802	\$132.70
½" - 14	T design	10000	MC804	119.35	MS804	140.40



316 stainless

Soft Tip Male

NPT Size	Handle Style	PSI at 200°F	Zinc Nickel Plated Steel		316 Stainless Steel	
			Part #	Price/E	Part #	Price/E
¼" - 18	T design	6000	MC852	\$104.60	MS852	\$132.70
½" - 14	T design	6000	MC854	119.35	MS854	140.40



316 stainless

Valves

Button

Valves



Thread	Brass	
	Part #	Price/E
1/4" NPT female	BV2F	\$24.75
1/4" NPT male	BV2M	24.75

Tank Filler



TFV1S

TFV2

Applications:

- used on compressed air tanks and other applications

Feature:

- standard valve stem thread

Connection	Length	Nickel Plated		Length	Brass	
		Part #	Price/E		Part #	Price/E
1/8" NPT	.85"	TFV1S	\$5.10	---	---	---
	1.24"	TFV1L	6.30	---	---	---
1/4" NPT	1"	TFV2	5.95	---	---	---
1/4" barb	---	---	---	1.57"	TFV2HB	\$8.45

TFV1L

TFV2HB

Brass Lever External Drains

Application:

- for air service only 

Feature:

- maximum operating pressure: **30 PSI** at ambient temperature **70°F (21°C)**

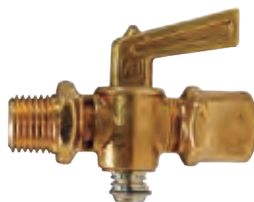

Female NPT	Male NPT	Brass	
		Part #	Price/E
1/4"	1/4"	LDC2	\$32.00

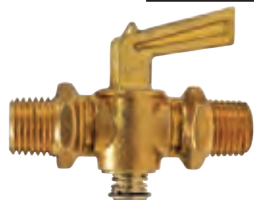

Male NPT	Male NPT	Brass	
		Part #	Price/E
1/4"	1/4"	LDCM2	\$35.50



Female NPT	Female NPT	Brass	
		Part #	Price/E
1/4"	1/4"	LDCF2	\$34.00

Brass External Drain Cocks

Applications:

- designed for low pressure water and air applications

Feature:

- maximum operating pressure: **150 PSI** at ambient temperature (**70°F (21°C)**)



NPT Size	Brass	
	Part #	Price/E
1/8"	D02	\$3.50
1/4"	D04	5.05

Needle Valves

Features:

- metal-to-metal seats allow positive sealing and flow adjustment
- designed for air and water applications
- maximum working pressure: **150 PSI** at ambient temperature **70°F (21°C)**

female x female

Female NPT	Female NPT	Brass	
		Part #	Price/E
1/8"	1/8"	NV2F	\$16.30
1/4"	1/4"	NV4F	24.25



Valves

male x male

Male NPT	Male NPT	Brass	
		Part #	Price/E
1/4"	1/4"	NV4M	\$22.50



Safety Check Valves

Valves

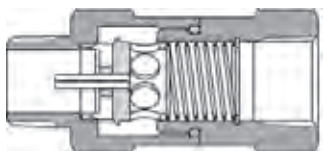

Open Position

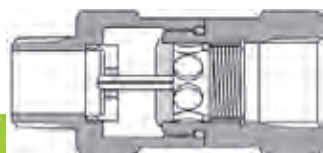

Closed Position

Application:

- used in temporary plant/factory air lines, construction sites, shipyards or utilities
- not for use in applications where 100% of the available air is required, i.e. sand blast, pile driving rigs, expansion joint blow down pipes, etc.



Features:

- high flow valve provides optimum performance
- controls excess air flow (SCFM) in only one direction
- automatically senses change in air flow and shuts off the flow in the event of a surge in excess of valve flow rating thus preventing hose whip
- solid brass body and valve
- stainless steel spring and roll pin
- maximum operating pressure: **350 PSI**
- maximum temperature: **250°F (121°C)**
- does not prevent backflow

Specification:

- conforms to OSHA regulation 1926.302 (b) (7) requiring a safety device at the source of the air supply and at branch air lines

How It Works:

- Safety check valves utilize the pressure differential across the valve to operate the valve and spring assembly. The pressure differential is directly related to the flow of air (SCFM) through the valve.
- When the pressure differential is within the operating limits - below the cutoff flow - of the unit, the force on the valve exerted by the spring is greater than that caused by the pressure differential (see "Open Position" graphic above). The valve remains open and normal operation continues.
- When the pressure differential is above the cutoff limit, the force on the valve exerted by the pressure differential is greater than the force exerted by the spring, and the valve closes (see the "Closed Position" graphic above).
- After the repair is made, normal operation is automatically enabled when pressure across the valve equalizes through the bleeder hole.
- The valve spring size can be specified by determining the air flow during normal operation and by estimating the air flow if a failure or rupture occurs.

NPT & Hose ID Size	Cut-off Flow Rate (SCFM at 90 PSI)	Brass		NPT & Hose ID Size	Cut-off Flow Rate (SCFM at 90 PSI)	Brass	
		Part #	Price/E			Part #	Price/E
1/4"	23-29	SCVL2	\$65.08	1 1/4"	260-290	SCVL10	\$242.37
	30-36	SCVL3	61.05		300-340	SCVM10	242.37
	39-47	SCVM3	61.05		440-500	SCVS10	242.37
3/8"	52-65	SCVS3	61.05	1 1/2"	570-630	SCVH10	242.37
	70-78	SCVM4	65.55		300-360	SCVL12	406.54
	80-96	SCVS4	65.55		470-530	SCVM12	406.54
1/2"	72-88	SCVL6	103.75	1 1/2"	564-602	SCVX12	406.54
	92-108	SCVM6	103.75		640-720	SCVS12	406.54
	112-128	SCVR6	103.75		750-830	SCVH12	406.54
	132-148	SCVJ6	103.75	2"	510-590	SCVL16	555.14
	160-180	SCVS6	103.75		725-825	SCVM16	555.14
	180-200	SCVH6	103.75		900-1050	SCVS16	555.14
1"	165-195	SCVL8	117.33	1 1/2"	1100-1200	SCVH16	555.14
	220-260	SCVM8	117.33		3"	1200-1400	SCVL24
	280-320	SCVS8	117.33	2400-2700		SCVS24	2357.34
	310-340	SCVH8	117.33	2850-3050	SCVH24	2357.34	

Safety Pop-Off Valves

Applications:

- for use on compressors and in compressed air service

Features:

- designed to protect un-fired pressure vessels from over-pressure
- ASME Code, National Board Certified
- CSA B51-03 certified
- maximum temperature: **400°F (204°C)**

Soft Seat

Feature:

- constructed of precision machined brass bar stock with a silicone disc sealing on the brass

Male NPT	Preset Pressure PSI	SCFM	Brass	
			Part #	Price/E
1/4"	100	51	KSV10-100	\$16.40
	125	62	KSV10-125	16.40
	150	73	KSV10-150	16.40
	175	84	KSV10-175	16.40



Standard

Features:

- brass valves are supplied with a stainless steel ball
- stainless valves are all stainless construction with a soft seat

Male NPT	Preset Pressure PSI	SCFM	Brass		SCFM	Stainless Steel	
			Part #	Price/E		Part #	Price/E
1/4"	30	35	SV30	\$35.75	35	SV30SS	\$198.00
	100	89	SV100	35.75	92	SV100SS	198.00
	125	109	SV125	35.75	112	SV125SS	198.00
	150	129	SV150	35.75	132	SV150SS	198.00
	175	149	SV175	35.75	153	SV175SS	198.00
	200	168	SV200	35.75	173	SV200SS	198.00



Heavy Duty, High Capacity

Feature:

- all brass construction with stainless steel ball on a precision machined brass seat

Male NPT	Preset Pressure PSI	SCFM	Brass	
			Part #	Price/E
1/2"	30	73	SV30HD¹	\$84.20
	100	208	SV100HD	84.20
	125	254	SV125HD	84.20
	150	300	SV150HD	84.20
	175	346	SV175HD	84.20
	200	391	SV200HD	84.20



¹ constructed with soft seat

Series C Check Valves

Valves



brass



steel

Features:

- provides free flow in one direction and dependable shutoff in the opposite direction
- maximum operating pressure: **2000 PSI** at ambient temperature **70°F (21°C)**
- cracking pressure: **5 PSI**

Female NPT	Free Flow GPM	Maximum Operating PSI at 70°F (21°C)	Brass		Maximum Operating PSI at 70°F (21°C)	Steel	
			Part #	Price/E		Part #	Price/E
1/8"	3	2000	BCV200	\$59.60	5000	SCV200	\$64.85
1/4"	5	2000	BCV400	55.90	5000	SCV400	65.00
3/8"	8	2000	BCV600	85.15	5000	SCV600	77.00
1/2"	15	2000	BCV800	109.85	5000	SCV800	85.50

Domestic Ball Cone Check Valves

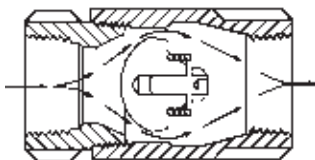

Pressure Ratings

Temperature	Pressure WOG (PSI)
-20°F to 100°F (-29°C to 38°C)	400
200°F (93°C)	200
250°F (121°C)	160
275°F (135°C)	150
300°F (149°C)	140
325°F (163°C)	130
353°F (178°C)	125

Application:

- For use with water, oil or inert gases. Not recommended for use on or near reciprocating pumps or other similar vibration causing machinery.

Features:

- tight shut-off with liquid media
- no radial alignment necessary
- straight through and streamlined for minimum change in velocity
- Reinforced PTFE check is spring loaded for fast seating action.
- pressure rating: **400 PSI** WOG, cold non-shock; **125 PSI** saturated steam
- cracking pressure: **.5 PSI**
- temperature range: **-20°F to 353°F (-29°C to 178°C)**

Ball Cone Check Valve Female NPT x Female NPT

Size	Brass		316 Stainless Steel	
	Part #	Price/E	Part #	Price/E
1/4"	61-101	\$62.00	62-101	\$136.00
3/8"	61-102	62.00	62-102	136.00
1/2"	61-103	62.00	62-103	160.00
3/4"	61-104	89.00	62-104	256.00
1"	61-105	120.00	62-105	350.00
1 1/4"	61-106	212.00	62-106	490.00
1 1/2"	61-107	268.00	62-107	660.00
2"	61-108	440.00	62-108	1140.00
2 1/2"	61-109	900.00	---	---
3"	61-100	1500.00	---	---



Ball Cone Check Valve Male NPT x Female NPT

Size	Brass	
	Part #	Price/E
1/4"	61-201	\$85.50
3/8"	61-202	85.50
1/2"	61-203	85.50
3/4"	61-204	112.00
1"	61-205	162.00
1 1/4"	61-206	264.00
1 1/2"	61-207	335.00
2"	61-208	560.00



800 PSI Stainless Steel Check Valves

Features:

- soft PTFE seat is spring loaded for fast seating action
- flow profile designed to minimize head loss
- temperature range: **10°F to 450°F (-12°C to 232°C)**
- pressure rating: **800 PSI WOG**; **125 PSI** saturated steam
- cracking pressure: **.5 PSI**
- corrosion resistance, excellent for use on chemicals
- dual guided stem and disc

Female NPT	316 Stainless Steel	
	Part #	Price/E
1/4"	SSCVIL025	\$114.00
3/8"	SSCVIL038	114.00
1/2"	SSCVIL050	114.00
3/4"	SSCVIL075	169.00
1"	SSCVIL100	200.00
1 1/4"	SSCVIL125	339.00
1 1/2"	SSCVIL150	416.00
2"	SSCVIL200	472.00



Valves

Forged Steel Check Valves

Features:

- Class 800
- ASTM A105, ANSI B120.1
- bolted bonnet
- pressure rating: **1975 PSI**
- maximum temperature: **800°F (427°C)**
- can be used for steam service

Female NPT	Forged Steel	
	Part #	Price/E
1/2"	FSCV50	\$129.45
3/4"	FSCV75	145.00
1"	FSCV100	203.70
1 1/4"	FSCV125	355.60
1 1/2"	FSCV150	378.05
2"	FSCV200	453.95



Spring-Loaded Check Valves

Features:

- cracking pressure: 0.50 PSI
- NBR seat
- soft seat for bubble tight shutoff, spring loaded for fast seating action
- flow profile designed to minimize head loss
- pressure rating :1/2" - 2" **400 PSI WOG**; 3" - 4" **175 PSI WOG**
- temperature range: **10°F to 210°F (-10°C to 100°C)**

Female NPT	Brass	
	Part #	Price/E
1/2"	CV050	\$18.60
3/4"	CV075	25.00
1"	CV100	34.00
1 1/4"	CV125	53.00
1 1/2"	CV150	79.30
2"	CV200	112.75
3"	CV300	355.90
4"	CV400	550.00



Strainer with Spring-Loaded Check Valves

Features:

- brass with NBR seat and stainless steel strainer
- soft seat for bubble tight shutoff, spring loaded for fast seating action
- flow profile designed to minimize head loss
- temperature range: **10°F to 210°F (-10°C to 100°C)**
- cracking pressure: **0.50 PSI**
- pressure rating: **1½"-2" 400 PSI WOG, 3"-4" 175 PSI WOG**



Female NPT	Brass	
	Part #	Price/E
1½"	BVFS20	\$89.60
2"	BVFS25	129.00
3"	BVFS35	379.50
4"	BVFS40	572.50

Horizontal Swing Check Valves

Applications:

- for use in plumbing and liquid piping systems to prevent back flow

Features:

- full flow performance with a minimum of turbulence or pressure loss
- brass disc
- for horizontal or vertical use
- A positive seating disc allows flow only in one direction and a screw-in cap provides easy access for periodic cleaning.
- pressure rating: **200 PSI WOG**
- temperature range: **-20° to 150°F (-29°C to 66°C)**



Female NPT	Brass	
	Part #	Price/E
½"	SWCV50	\$19.90
¾"	SWCV75	26.10
1"	SWCV100	35.55
1¼"	SWCV125	56.50
1½"	SWCV150	71.10
2"	SWCV200	110.80
3"	SWCV300	309.80
4"	SWCV400	440.00

Domestic Swing Check Valves

Features:

- Class 150
- ASME B1.20.1
- metal seat
- 100% factory tested
- working pressure: **300 PSI cold, 150 PSI steam**
- temperature range: **-20°F to 406°F (-29°C to 208°C)**



Female NPT	Brass	
	Part #	Price/E
½"	DSCV50	\$154.00
¾"	DSCV75	187.00
1"	DSCV100	252.00
1¼"	DSCV125	333.00
1½"	DSCV150	432.00
2"	DSCV200	646.00

Domestic Cast Angle Valves



Features:

- UL listed and FM approved
- aluminum hand wheel
- working pressure: **300 PSI at 70°F (21°C)**

female x male

Inlet Female NPT	Outlet Male Thread	Cast Brass	
		Part #	Price/E
1½"	1½" NST (NH)	AV150	\$300.00
	1½" NPSH	AV150S	300.00
	1½" NPT	AV150T	300.00
2½"	2½" NST (NH)	AV250	473.65
	2½" NYFD	AV250NYFD¹	473.65

¹ supplied with red hand wheel

female x female

Inlet Female NPT	Outlet Female NPT	Cast Brass	
		Part #	Price/E
1½"	1½"	AVF150	\$300.00
2½"	2½"	AVF250	473.65



Valves

Replacement Parts

Description	Part #	Price/E
aluminum handwheel for 1½" valve	AV150-W	\$17.45
aluminum handwheel for 2½" valve	AV250-W	26.00
handwheel nut for 1½" valve	AV150-N	1.55
handwheel nut for 2½" valve	AV250-N	1.50
valve seal rubber for 1½" valve	AV150-RBR	17.80
valve seal rubber for 2½" valve	AV250-RBR	18.70

Dimensions

Size	A	B	C closed	C open	D	F
1½"	2-11/64"	2-7/32"	6 ⁵ / ₈ "	7-21/32"	3 ³ / ₄ "	2-13/16"
2½"	3-3/16"	3-3/16"	9 ¹ / ₄ "	11"	5"	3-19/32"





500# Angle Hose Valves

Valves

Applications:

- fire department, gravity and pressure tank connections, test connections, and public water supplies to sprinkler and standpipe systems where it is necessary to access the system for a fire hose connection

Features:

- designed and approved to manage 500 PSI pressures in piping systems
- red handwheel
- FM approved
- New York City Board of Standards and Appeals, approval # MEA 54-07-E
- maximum operating pressure: **500 PSI at 70°F (21°C)**

Female x Male



Inlet Female NPT	Outlet Male Thread	Cast Brass	
		Part #	Price/E
2½"	2½" NST (NH)	AV5-250F	\$711.25
2½"	2½" NYFD	AV5-250NYFD	711.25

Female x Female



Inlet Female NPT	Outlet Female NPT	Cast Brass	
		Part #	Price/E
2½"	2½"	AVF5-250	\$711.25



Global Cast Angle Valves



Features:

- NPT inlet thread only
- aluminum handwheel
- working pressure: **300 PSI at 70°F (21°C)**
- UL listed and FM approved
- New York City Board of Standards and Appeals, approval # MEA 54-07-E
- available finishes:
 - cast (standard)
 - polished: -P
 - chrome: -C
- minimum quantity for special thread, consult Dixon®

Female Inlet

Inlet Female NPT	Outlet Male Thread	Cast Yellow DZR Brass	
		Part #	Price/E
1½"	1½" male NST (NH)	AV150-I	\$108.80
2½"	2½" male NST (NH)	AV250-I	222.00
2½"	2½" MNYFD	AV250NYFD-I	222.00



Double Female

Features:

- NPT inlet and outlet
- aluminum handwheel
- working pressure: **300 PSI at 70°F (21°C)**
- New York City Board of Standards and Appeals, approval # MEA 54-07-E
- available finish:
 - cast (standard)
 - polished = -P
 - chrome = -C

Inlet Female NPT	Outlet Female NPT	Cast Yellow DZR Brass	
		Part #	Price/E
1½"	1½"	AVF150-I	\$108.80
2½"	2½"	AVF250-I	222.00



Dimensions

Size	A	B	C closed	C open	D	E	Wt. in Lbs.
1½"	4.13"	3.75"	6.80"	7.78"	2.25"	1.81"	4.4
2½"	5.69"	5.00"	9.00"	10.72"	3.19"	2.59"	9.5

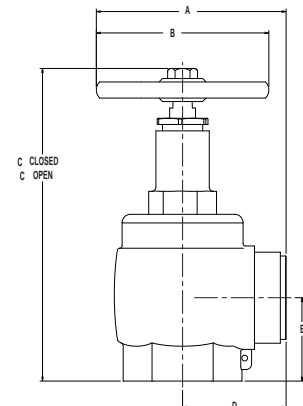



Global Forged Angle Hose Valves

Valves

Features:

- to be used with a fire hose rack assembly, or as a fire department outlet connection
- UL listed and FM approved
- red steel handwheel
- maximum operating pressure: **300 PSI at 70°F (21°C)**
- polished or chrome plated parts with other outlet threads are also available, consult Dixon® for information



Female x Male

Inlet Female NPT	Outlet Male Thread	Forged Brass	
		Part #	Price/E
1½"	1½" NST (NH)	AV151	\$174.05
2½"	2½" NST (NH)	AV251	302.75
	2½" NYC	AV251NYC	302.75
	2½" NYFD	AV251NYFD	302.75
	3" NST (NH)	AV2531	414.00



Female x Female

Inlet Female NPT	Outlet Female NPT	Forged Brass	
		Part #	Price/E
1½"	1½"	AVF151	\$174.05
2½"	2½"	AVF251	302.75

Replacement Parts



Description	Part #	Price/E
handwheel for 1½" valve	AV151-WR	\$32.90
handwheel for 2½" valve	AV251-WR	36.35
handwheel nut for 1½" and 2½" valve	AV251-N	1.35
valve seal rubber for 1½" valve	AV151-RBR	16.95
valve seal rubber for 2½" valve	AV251-RBR	15.15

Non-rising Stem Wedge Disc Gate Valves



Features:

- red iron handwheel, with brass cap and chain
- cap not included on the NYFD threaded valve and special threaded valves
- solid wedge disc with tapered seats
- 2½" UL listed and FM approved
- FM approved
- working pressure: **300 PSI at 70°F (21°C)**
- other configurations are available, contact Dixon® for additional information

Inlet Female NPT	Outlet Male Thread	UL Listed	Cast Brass	
			Part #	Price/E
1½"	1½" NST (NH)	no	WDGV150F	\$515.00
2½"	2½" NST (NH)	yes	WDGV250F	888.00
2½"	2½" NYFD	yes	WDGV250NYFD	888.00



Valves

Dimensions

Size	A	B	C	D
1½"	3-49/64"	5⅝"	1⅛"	6⅞"
2½"	6"	10¾"	2½"	13¼"

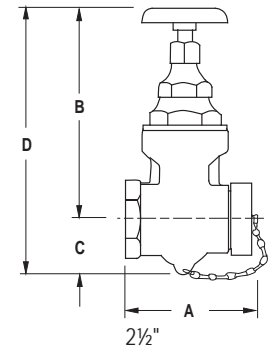

Global Non-rising Stem Wedge Disc Gate Valves



Features:

- working pressure: **300 PSI (2069 kPa)**
- custom male thread available
- UL listed and FM approved
- non-rising stem
- cast brass with solid wedge disc and tapered seats
- red iron wheel handle with cap and chain (cap not supplied on non-standard threads)
- alloy = DZR brass
- furnished with 2½" NST brass cap and chain
- available finishes:
 - cast (standard)
 - polished trim - P
 - cast chrome - RC
 - polished chrome trim - C

Inlet Female NPT	Outlet Male NST	UL Listed	Cast DZR Brass	
			Part #	Price/E
2½"	2½"	yes	GWGDV250F	\$280.40



Dimensions

Size	A	B	C	D
2½"	5"	7¾"	2½"	10"

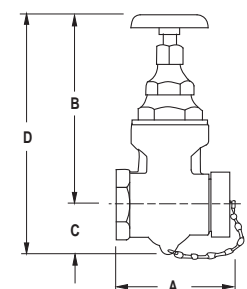



Non-rising Stem Wedge Disc Gate Valves

Valves



Applications:

- for use on standpipes, fire pumps and hydrants

Features:

- satin finish
- red handwheel
- solid wedge disc with tapered seats
- straightway pattern
- UL listed and FM approved
- working pressure: **300 PSI at 70°F (21°C)**

Inlet Female NPT	Outlet Male NST (NH)	Forged Brass	
		Part #	Price/E
2½"	2½"	WDGV251F	\$505.40
3"	2½"	WDGV3025F	610.75

Rising Stem Wedge Disc Gate Valves



Features:

- red iron handwheel, with brass cap and chain
- solid wedge disc with tapered seats
- not recommended for wet standpipe systems, use AV250 (18-157) for this purpose, see page I-31
- other configurations are available, contact Dixon® for additional information



Inlet Female NPT	Outlet Male	Working Pressure PSI	Cast Brass	
			Part #	Price/E
2½"	2½" NST (NH)	200	RWDGV250F	\$938.25
3"	2½" NST (NH)	300	RWDGV3025F¹	1032.50

¹ UL listed

Dimensions

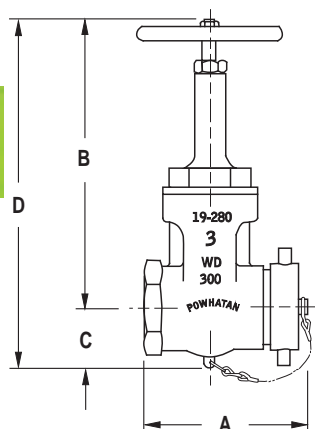

Size	A	B closed	C	D closed	D open
2½"	6½"	11	2½"	13½"	16¼"
3" x 2½"	6-3/16"	11	2½"	13½"	16¼"



Single Hydrant Gate Valves with Hand Wheel

Application:

- used to throttle the flow from a fire hydrant preventing damage to the hydrant

Features:

- O-ring seal
- UL listed
- for use on standpipes and fire pumps where UL listing is required
- maximum operating pressure: **175 PSI** (water only) at **70°F (21°C)**
- other configurations are available, contact Dixon® for additional information



Valves

Inlet Female	Outlet Male	Cast Red Brass	
		Part #	Price/E
2½" NST (NH)	2½" NST (NH)	UHGV250F	\$450.00
2½" NST (NH)	2½" NST (NH)	UHGV250F-D	595.70

Replacement Part

Description	Part #	Price/E
handwheel	UHGV250-W	\$23.00



Single Hydrant Gate Valves with Speed Handle

Application:

- used to throttle the flow from a fire hydrant preventing damage to the hydrant

Features:

- pin lug swivel, non-rising stem, aluminum speed handle
- rubber seal
- for use on hydrants, standpipes, and fire pumps
- maximum operating pressure: **175 PSI** (water only) at **70°F (21°C)**
- other configurations are available, contact Dixon® for additional information



Inlet Female	Outlet Male	Cast Red Brass	
		Part #	Price/E
2½" NST (NH)	2½" NST (NH)	HGV250F	\$318.00
2½" NST (NH)	2½" NST (NH)	HGV250F-D	499.00
2½" NST (NH)	2½" NPSH	HGV250	318.00

Replacement Part

Description	Aluminum	
	Part #	Price/E
speed handle	HGV250-H	\$18.00





Single Hydrant Gate Valves with Handwheel

Application:

- protects fire hydrants from damage that can occur if they are used for throttling

Features:

- pin lug swivel, non-rising stem, red handwheel
- metal to metal seal
- UL listed
- for use on hydrants, standpipes, and fire pumps
- maximum operating pressure: **300 PSI** (water only) at **70°F (21°C)**



Inlet Female	Outlet Male	Forged Brass	
		Part #	Price/E
2½" NST (NH)	2½" NST (NH)	HGVW250F	\$540.75

Replacement Part



Description	Part #	Price/E
handwheel	HGVW250-W	\$50.15

Hydrant Gate Valves with Speed Handle

Features:

- protects fire hydrants from damage that can occur if they are used for throttling
- full 2½" waterway
- anodized throughout - minimum thickness 0.001"
- test pressure: **250 PSI**, working pressure: **100 PSI** at **70°F (21°C)**



Inlet Female Swivel	Outlet Male	Aluminum Alloy, 356-T6	
		Part #	Price/E
2½" NPSH	2½" NPSH	AHGV250	\$656.25
2½" NST (NH)	2½" NST (NH)	AHGV250F	656.25

Replacement Part



handwheel and knob

Description	Part #	Price/E
handwheel and knob	HGV-HDWHL	\$48.00
knob only	HGV-KNOB	22.80

Global Hydrant Gate Valves with Speed Handle

Application:

- protects fire hydrants from damage that can occur if they are used for throttling

Features:

- pin lug swivel, non-rising stem, aluminum speed handle
- non-metallic seal
- maximum operating pressure: **175 PSI** (water only) at **70°F (21°C)**



Inlet Female NST (NH)	Outlet Male NST (NH)	Aluminum Alloy	
		Part #	Price/E
2½"	2½"	AHGV250F-I	\$394.30

Replacement Part



Description	Aluminum	
	Part #	Price/E
speed handle	AHGV250F-H	\$68.75

Large Diameter (LDH) Gate Valves

Application:

- used on the suction intake and discharge sides of a pumper or on a hydrant

Features:

- 30° elbow needs only 8 easy turns to open and close
- non-rising stem, with an air bleed off
- finish anodized throughout - minimum thickness 0.001"
- maximum operating pressure: **280 PSI at 70°F (21°C)**, without relief valve
- 4½" minimum waterway

Storz x Storz

Inlet Storz	Outlet Storz	Length	Width	Height	Aluminum Alloy, 356-T6	
					Part #	Price/E
4"	4"	9"	6¼"	19½"	SGV440	\$2190.80
	5"	9"	7¾"	19½"	SGV450	2468.20
5"	4"	9"	7¾"	19½"	SGV540	2503.35
	5"	9"	7¾"	19½"	SGV550	2375.65

- all measurements include handles



Storz x Storz 30° with Air Bleeder

Inlet Storz	Outlet Storz	Length	Width	Height	Aluminum Alloy, 356-T6	
					Part #	Price/E
4"	4"	9"	6¼"	20.0"	SGV440	\$2190.80
	5"	9"	7¾"	20.0"	SGV450	2468.20
5"	4"	9"	7¾"	20.0"	SGV540	2503.35
	5"	9"	7¾"	20.0"	SGV550	2375.65

- all measurements include handles



Storz x Female Swivel

Inlet Storz	Outlet Female NST Swivel	Length	Width	Height	Aluminum Alloy, 356-T6	
					Part #	Price/E
4"	4"	9"	6"	19½"	FSGV440F	\$2217.55
	4½"	9"	6½"	19½"	FSGV445F	2222.40
	5"	9"	7"	19½"	FSGV450F	2344.40
	6"	9"	8"	19½"	FSGV460F	2350.80
5"	4"	9"	6"	19½"	FSGV540F	2342.95
	4½"	9"	6½"	19½"	FSGV545F	2347.75
	5"	9"	7"	19½"	FSGV550F	2469.75
	6"	9"	8"	19½"	FSGV560F	2392.90

- all measurements include handles



Wharf Hydrants

Valves



Features:

- used to provide a fire department outlet connection
- pentagon nut at top of spindle discourages unauthorized use
- hydrostatically tested
- maximum operating pressure: **300 PSI at 70°F (21°C)**

Inlet Female NPT	Outlet Male NST (NH)	Height Open	Height Closed	Cast Brass	
				Part #	Price/E
3"	2½"	16.38	14.25	WHYD3025F	\$932.15
4"	2½"	16.38	14.25	WHYD4025F	1053.70
4"	4½"	18.13	15.63	WHYD4045F	1310.00

Replacement Parts



hand wheel



pentagon hex nut

Description	Part #	Price/E
hand wheel	46-030-00025	\$26.00
pentagon hex nut	44-251-00006	40.25

Forestry Grade ¼ Turn Ball Type Wye Valves

Features:

- cast aluminum swivel inlet, anodized body, hard-coated threads
- built to US Forest Service specifications
- 1" and 1½" for use up to **600 PSI** (water/AFFF only); 2½" for use up to **400 PSI** (water/AFFF only)



1" - 1½"



2½"

Female Thread	(2) Male Threads	Cast Aluminum	
		Part #	Price/E
1" NPSH	1" NPSH	FWV10S10S	\$661.95
1½" NPSH	1½" NPSH	FWV15S15S	763.80
1½" NST (NH)	1½" NST (NH)	FWV15F15F	763.80
2½" NST (NH)	1½" NST (NH)	FWV25F15F	763.80
2½" NST (NH)	2½" NST (NH)	FWV25F25F	2041.25

1/4 Turn Plug Type Wye Valves

Features:

- pin lug swivel
- maximum operating pressure: **175 PSI** (water only) at **70°F (21°C)**
- not recommended for charged pre-connected hose 



Inlet Female NST (NH)	(2) Outlets Male	Cast Brass	
		Part #	Price/E
2½"	1½" NST (NH)	S6175	\$748.75
2½"	1½" NPSH	S6175S	813.00

1/4 Turn Ball Type Wye Valve

Features:

- rocker lug swivel
- operates easily under high pressure
- handles are not field replaceable
- seals on the ball are field adjustable and field replaceable
- maximum operating pressure: **175 PSI** (water only) at **70°F (21°C)**



Specification:

- meets NSN specifications # 4210-00-255-0234

Inlet Female	(2) Outlets Male	Cast Brass	
		Part #	Price/E
2½" NST (NH)	1½" NPSH	S7337S	\$1084.00

Full Flow 1/4 Turn Ball Type Wye Valves

Features:

- recommended for charged pre-connected hose lines
- pin lug swivel
- maximum operating pressure: **175 PSI** (water only) at **70°F (21°C)**
- other configurations are available, contact Dixon® for additional information



Inlet Female Swivel	(2) Outlets Male	Cast Brass	
		Part #	Price/E
1½" NPSH	1½" NPSH	S7100-15S	\$298.00
1½" NST (NH)	1½" NST (NH)	S7100-15	298.00
2½" NST (NH)	1½" NST (NH)	S7100	298.00

Leader Line 1/4 Turn Ball Type Wye Valve

Features:

- body painted red with chrome trim
- maximum operating pressure: **400 PSI** (water only) at **70°F (21°C)**



Inlet Female NST (NH)	(2) Outlets Male NST (NH)	Brass	
		Part #	Price/E
2½"	1½"	LLBV2515F	\$934.25

2-Way Ball Valves

Valves



Inlet Female Swivel	(2) Outlet Male	Aluminum	
		Part #	Price/E
1 1/2" NST (NH)	1 1/2" NST (NH)	FMBV15F15F	\$401.20
1 1/2" NPSH	1 1/2" NPSH	FMBV15S15S	401.20
2 1/2" NST (NH)	1 1/2" NST (NH)	FMBV25F15F	628.15
2 1/2" NST (NH)	2 1/2" NST (NH)	FMBV25F25F	1699.00
4" NST (NH)	2 1/2" NST (NH)	FMBV40F25F	1971.10
4 1/2" NST (NH)	2 1/2" NST (NH)	FMBV45F25F	2164.85
5" NST (NH)	2 1/2" NST (NH)	FMBV50F25F	1541.40
6" NST (NH)	2 1/2" NST (NH)	FMBV60F25F	1586.55

Plain **Wyes** with Pin Lugs

Features:

- divides one stream into two
- other configurations are available, contact Dixon® for additional information



Inlet Female	(2) Outlets Male	Cast Brass	
		Part #	Price/E
1 1/2" NST (NH)	1 1/2" NST (NH)	PW15F15F	\$125.00
1 1/2" NPSH	1 1/2" NPSH	PW15S15S	265.05
2 1/2" NST (NH)	1 1/2" NST (NH)	PW25F15F	190.00
2 1/2" NST (NH)	2 1/2" NST (NH)	PW25F25F	225.00

Straight Globe Valves

Features:

- ideal for wet and combination systems
- used with a fire hose rack assembly, or as a fire department outlet connection
- aluminum handwheel
- maximum operating pressure: **300 PSI at 70°F (21°C)**

Female x Male

Inlet Female NPT	Outlet Male NST (NH)	Cast Brass	
		Part #	Price/E
1½"	1½"	SGV150F	\$374.05
2½"	2½"	SGV250F	566.70



Valves

Female x Female

Inlet Female NPT	Outlet Female NPT	Cast Brass	
		Part #	Price/E
1½"	1½"	SGVF150	\$448.20
2½"	2½"	SGVF250	635.35



Dimensions

Size	A	B	C closed	D open
1½"	2 ³ / ₈ "	4 ³ / ₄ "	7 ¹ / ₄ "	8"
2½"	3-9/32"	6-9/16"	7 ³ / ₈ "	8 ¹ / ₈ "

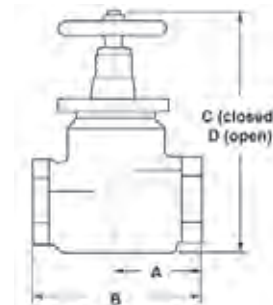

Angled Ball Drip Valves

Features:

- seals automatically under pressure
- installed horizontally, the ball seats at approximately **8-10 PSI**
- working pressure: **175 PSI at 70°F (21°C)**

Male NPT	Male NPT	Brass	
		Part #	Price/E
½"	½"	ASBDV50	\$161.00
¾"	¾"	ASBDV75	161.00

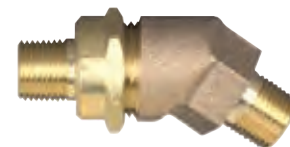

Straight Ball Drip Valves

Application:

- designed to drain the low point of a system

Features:

- place valve between a fire department connection and a swing check valve
- seals automatically under pressure
- install horizontally
- working pressure: **175 PSI at 70°F (21°C)**

Male NPT	Male NPT	Brass	
		Part #	Price/E
½"	½"	SBDV50	\$26.60
¾"	¾"	SBDV75	30.00





Factory Set Pressure Reducing Brass Angle Valves

Valves

Features:

- true combination shut-off and pressure reducing valves
- 1½" reduces inlet pressure of 300 PSI (2069 kPa) or less to working pressures of **10 through 175 PSI** (69-1207 kPa); 2½" reduces inlet pressures of 400 PSI (2758 kPa) or less to working pressures of **20 through 175 PSI** (138-1207 kPa) under discharge or static conditions
- female x female valves have an open / closed indicator bonnet for confirmation of status
- tamper resistant and automatic
- available with a tamper proof switch
- all debris must be flushed from the system prior to being placed into service
- complete switch, bracket and housing available for field mounting, consult Dixon® for price and availability
- other configurations are available, contact Dixon® for additional information

Specifications:

- UL listed for Automatic Sprinkler Systems as floor or zone control valves
- Standpipe Systems, Class I, II and III
- Automatic Check Valve for Dual Riser Systems
- Approved by New York City Board of Standards and Appeals, approval # MEA 54-07-E
- Approved by City of Los Angeles and the City of San Francisco (ULC 2½")



Female x Male

Inlet Female NPT	Outlet Male NST (NH)	Cast Brass	
		Part #	Price/E
1½"	1½"	<i>NAPRAV150F-15</i>	\$720.00
		<i>NAPRAV150F-20</i>	720.00
		<i>NAPRAV150F-25</i>	720.00
		<i>NAPRAV150F-30</i>	720.00
		<i>NAPRAV150F-35</i>	720.00
2½"	2½"	<i>NAPRAV250F-55</i>	940.00
		<i>NAPRAV250F-60</i>	940.00
		<i>NAPRAV250F-65</i>	940.00
		<i>NAPRAV250F-70</i>	940.00
		<i>NAPRAV250F-75</i>	940.00
		<i>NAPRAV250F-80</i>	940.00

Female x Female



Inlet Female NPT	Outlet Female NPT	Cast Brass	
		Part #	Price/E
1½"	1½"	<i>NAPRAVF150-15</i>	\$720.00
		<i>NAPRAVF150-20</i>	720.00
		<i>NAPRAVF150-25</i>	720.00
		<i>NAPRAVF150-30</i>	720.00
		<i>NAPRAVF150-50</i>	720.00
2½"	2½"	<i>NAPRAVF250-55</i>	940.00
		<i>NAPRAVF250-60</i>	940.00
		<i>NAPRAVF250-65</i>	940.00
		<i>NAPRAVF250-70</i>	940.00
		<i>NAPRAVF250-75</i>	940.00
		<i>NAPRAVF250-80</i>	940.00

Dimensions

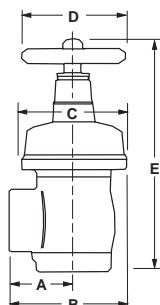

Size	A	B	C	D	E closed	E open
1½"	2-7/32"	4-5/32"	3⅞"	3¾"	9-25/64"	8-53/64"
2½"	3-7/32"	6-3/32"	5¾"	5¾"	11⅞"	10-13/16"

Factory Set Pressure Reducing Brass Standard Globe Valve



Female x Female

Inlet Female NPT	Outlet Female NPT	Cast Brass	
		Part #	Price/E
2½"	2½"	NAPRVF250-55	\$940.00
		NAPRVF250-60	940.00
		NAPRVF250-65	940.00
		NAPRVF250-70	940.00
		NAPRVF250-75	940.00
		NAPRVF250-80	940.00



Valves

Grooved x Grooved

Inlet Grooved	Outlet Grooved	Cast Brass	
		Part #	Price/E
2½"	2½"	NAPRVGT250-55	\$1181.10
		NAPRVGT250-60	1181.10
		NAPRVGT250-65	1181.10
		NAPRVGT250-70	1181.10
		NAPRVGT250-75	1181.10
		NAPRVGT250-75	1181.10



Dimensions

Size	Style	A	B	C	D	E closed	E open
2½"	NPT	3⅞"	7¾"	5¾"	5¾"	12¾"	12-13/16"
2½"	grooved	4⅜"	8¾"	5¾"	5¾"	12¾"	12-13/16"

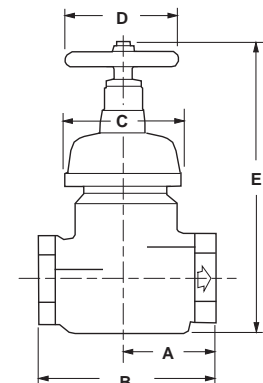

Accessories

Description	Part #	Price/E
2½" tamper switch bracket kit (bonnet, nut, switch, bracket)	4201901587	\$307.40
switch bracket only	18-458-00017	52.95
replacement handles for 1½" valves	AV150-W	17.45
replacement handles for 2½" valves	46-030-00025	26.00





Factory Set Pressure Reducing (regulating) Valves

Features:

- (4) drilled and tapped bosses:
 - two on each side for upstream and downstream pressure monitoring
 - saves installation time and provides a cleaner appearance
- 2½" size reduces inlet pressures of **400 PSI** (2758 kPa) or less to desired working pressures from **20** through **175 PSI** (138-1207 kPa) under discharge or static conditions
- UL listed
- tamper switch available

Valves



angle grooved x grooved

Inlet Grooved	Outlet Grooved	Cast Brass	
		Part #	Price/E
2½"	2½"	NAPRAVGT250-55	\$1181.10
		NAPRAVGT250-60	1181.10
		NAPRAVGT250-65	1181.10
		NAPRAVGT250-70	1181.10
		NAPRAVGT250-75	1181.10
		NAPRAVGT250-80	1181.10
		NAPRAVGT250-85	1181.10
		NAPRAVGT250-95	1181.10



angle grooved x female

Inlet Grooved	Outlet Female NPT	Cast Brass	
		Part #	Price/E
2½"	2½"	NAPRAVGFT250-55	\$1181.10
		NAPRAVGFT250-60	1181.10
		NAPRAVGFT250-65	1181.10
		NAPRAVGFT250-70	1181.10
		NAPRAVGFT250-75	1181.10
		NAPRAVGFT250-80	1181.10
		NAPRAVGFT250-85	1181.10
		NAPRAVGFT250-95	1181.10



globe female x female

Inlet Female NPT	Outlet Female NPT	Cast Brass	
		Part #	Price/E
2½"	2½"	NAPRVFT250-55	\$1181.10
		NAPRVFT250-60	1181.10
		NAPRVFT250-65	1181.10
		NAPRVFT250-70	1181.10
		NAPRVFT250-75	1181.10
		NAPRVFT250-80	1181.10
		NAPRVFT250-85	1181.10
		NAPRVFT250-95	1181.10



globe grooved x grooved

Inlet Grooved	Outlet Grooved	Cast Brass	
		Part #	Price/E
2½"	2½"	NAPRVGT250-55	\$1181.10
		NAPRVGT250-60	1181.10
		NAPRVGT250-65	1181.10
		NAPRVGT250-70	1181.10
		NAPRVGT250-75	1181.10
		NAPRVGT250-80	1181.10
		NAPRVGT250-85	1181.10
		NAPRVGT250-95	1181.10

Dimensions

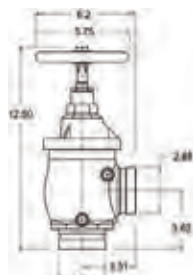

grooved x grooved angle valve

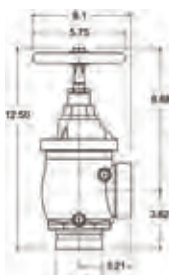

grooved x female angle valve

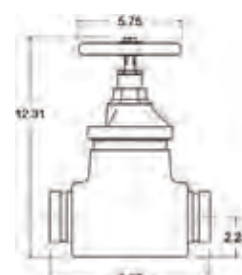

grooved x grooved globe valve

Field Adjustable Pressure Reducing Valves



Features:

- UL listed
- allows flexibility during installation with the ability to adjust settings once installed as hydraulic conditions change
- used in applications where the inlet pressure is greater than **175 PSI**
- 1/4" NPT gauge ports - both sides, drilled and tapped standard
- 3/8" adjusting rod included

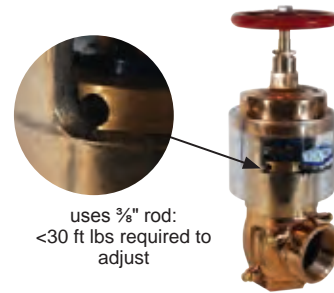

uses 3/8" rod:
<30 ft lbs required to adjust

Valves

angle valves

Inlet	Outlet	Cast Brass	
		Part #	Price/E
2 1/2" FNPT	2 1/2" MNST	FAPRAV250F	\$1820.55
2 1/2" FNPT	2 1/2" FNPT	FAPRAVF250	1820.55
2 1/2" groove	2 1/2" MNST	FAPRAVG250F	1820.55
2 1/2" groove	2 1/2" groove	FAPRAVG250G	1820.55



straight valves

Inlet	Outlet	Cast Brass	
		Part #	Price/E
2 1/2" groove	2 1/2" groove	FAPRVG250	\$1820.55
2 1/2" FNPT	2 1/2" FNPT	FAPRVF250	1820.55



Replacement Parts

Description	Cast Iron	
	Part #	Price/E
handwheel	46-030-00025	\$26.00



Setting Instructions:

1. Determine desired outlet pressure for known inlet pressure.
2. Remove the tamper-resistant screw and slide the plastic cover up to access the adjusting nut.
3. Use a 3/8" diameter rod in any one of the 6 holes in the adjusting nut and rotate counter clockwise to increase the pressure at the outlet.
4. Check valve under pressure under static and under the anticipated flowing conditions to ascertain that the setting produces the expected results.

Adjustable Pressure Restricting Devices



Features:

- for installation on Class I or Class III standpipe system hose outlets
- device restricts pressure in the piping system to such a degree that hose lines can be handled by persons untrained in the handling of heavy fire streams
- New York City Board of Standards and Appeals, approval # MEA 54-07-E
- 2 1/2" UL listed
- working pressure: **175 PSI at 70°F (21°C)**

Female Thread	Male Thread	Cast Brass	
		Part #	Price/E
1 1/2" NST (NH)	1 1/2" NST (NH)	APRD150F	\$350.00
2 1/2" NST (NH)	2 1/2" NST (NH)	APRD250F	397.00





Domestic Adjustable Pressure Restricting Angle Valves

Valves



Application:

- used where flowing water pressure needs to be controlled

Features:

- preset orifices restrict the volume of water thereby lowering the pressure of the flowing water; NFPA requires restricting valves where inlet pressure exceeds 100 PSI
- restricting valve has no effect on the static pressure of a system
- can be manually by-passed if required by opening the valve fully, this is accomplished by breaking the breakable link, which allows the valve stem to rise to the full open position
- breakable link also serves as an indication of valve condition and status; if valve is opened without breaking the link it will resume its previous position and no resetting is necessary
- restricts inlet pressure from 70 PSI up to a maximum of 175 PSI
- restricts down to outlet pressures of 65, 80 or 100 PSI, outlet pressures may be set below 65 PSI when authorized by the local authority having jurisdiction
- restricts only under flow conditions
- setting charts are packed with valve
- UL listed
- New York City Board of Standards and Appeals, approval # MEA 54-07-E
- maximum operating pressure: up to **175 PSI**
- aluminum handwheel
- other configurations are available, contact Dixon® for additional information

female x male

Inlet Female NPT	Outlet Male NST (NH)	Cast Brass	
		Part #	Price/E
1½"	1½"	AVAPR150F	\$568.95
2½"	2½"	AVAPR250F	802.85

female x female

Inlet Female NPT	Outlet Female NPT	Cast Brass	
		Part #	Price/E
1½"	1½"	AVAPRF150	\$576.70
2½"	2½"	AVAPRF250	787.40



Global Adjustable Pressure Restricting Angle Valves



Application:

- used when flowing water pressure needs to be controlled

Features:

- preset orifices restrict the volume of water thereby lowering the pressure of the flowing water; NFPA requires restricting valves where inlet pressure exceeds 100 PSI
- restricting valve has no effect on the static pressure of a system
- restricting device can be manually by passed if required by opening the valve fully: pull the pin allowing the yoke to fall back from the valve stem which allows valve to be fully opened, when valve needs to be restricted again, slide the yoke back into place to be NFPA compliant

female x male

Inlet Female NPT	Outlet Male NST (NH)	Cast Brass	
		Part #	Price/E
1½"	1½"	AVAPR150F-I	\$126.70
2½"	2½"	AVAPR250F-I	268.35

female x female

Inlet Female NPT	Outlet Female NPT	Cast Brass	
		Part #	Price/E
1½"	1½"	AVAPRF150-I	\$126.70
2½"	2½"	AVAPRF250-I	268.35



Back Flow Preventer



Features:

- provides maximum protection against backflow caused by back-pressure or back-siphonage from a cross-connection wherein a contaminant hazard exists
- consists of two spring-loaded poppet type check valves and a mechanically independent, hydraulically dependent pressure differential relief valve
- three top mounted test cocks ensure easy access during repair and maintenance
- working pressure: to **175 PSIG**
- temperature range: **33°F to 180°F (.5°C to 82°C)**
- meets Foundation for Cross Connection Control and Hydraulic Research at University of Southern California Manual Section 10, ASSE 1015, AWWA C-510 and CSA B64.4 specifications
- UL listed and FM approved
- create a Fire Hydrant Backflow Preventer by using the **RSMSA25F20T** (page J-93) and the **DMH2025F** (page J-95)



Valves

NPT Thread	Brass	
	Part #	Price/E
2"	BFP200	\$1793.75

Groove x Groove Check Valves



Applications:

- Used in Fire Protection Systems to allow water flow in one direction only. Typical applications include: connections between public water supplies and private fire services systems, discharges from fire pumps, gravity tank connections and fire department pumper connections

Features:

- supplied with ¼" and ½" tapped NPT ports below the clapper and ¼" tapped NPT port above the clapper
- supplied with a 1½" NPT tapped boss below the clapper, boss above the clapper may be tapped for the addition of a ½" NPT drain
- for horizontal and vertical installation
- UL listed
- maximum operating pressure: **250 PSI** working pressure at **70°F (21°C)**



Description	Brass	
	Part #	Price/E
4" groove x 4" groove	SCVV400	\$364.90

Chicago Pattern Valves

Features:

- aluminum handwheel
- maximum operating pressure: **175 PSI** at **70°F (21°C)**

Inlet Male NPT	Outlet Male	Cast Brass	
		Part #	Price/E
1½"	1½" NST (NH)	CPV150F	\$363.65





Sprinkler Hose Valve



Features:

- aluminum wheel
- UL listed and FM approved for automatic sprinkler and standpipe systems
- working pressure: **175 PSI** (water only) at **70°F (21°C)**

Inlet Male NPT	Outlet Male NST (NH)	Cast Brass	
		Part #	Price/E
1"	1½"	ASHV1015F	\$373.25

Push Pull Drain Valve



Features:

- direct mount
- 2½" handle length

Inlet	Outlet	Brass	
		Part #	Price/E
¾" FNPT	¾" FNPT	PPDV75	\$88.00

Automatic Drain Vent Valve



Features:

- attaches to the hose end of a hose rack nipple keeping the hose free of moisture by draining water from a leaky valve; when the valve is opened for use a spring valve closes the drain and directs all water through the hose
- other threads and finishes are available, consult Dixon® for more information

Female NST (NH)	Male NST (NH)	Working Pressure (PSI)	Cast Brass	
			Part #	Price/E
1½"	1½"	175	ADV150F	\$427.45



Piston Intake Relief Valves

Features:

- standard with a 30° elbow (permitting smoother water flow), adjustable relief valve, retractable knob on hand wheel and air bleed off
- permits safe controlled flow to the intake pump and can also be used to draft
- 9 easy turns open and close the valve
- **280 PSI at 70°F (21°C)**, without relief valve
- 4½" minimum waterway
- finish anodized throughout - minimum thickness 0.001"
- relief valve - double spring, cartridge type, adjustable from **50 to 200 PSI**

Storz x Female Swivel

Storz	Female Swivel NST (NH)	Length	Width	Height	Aluminum Alloy, 356-T6	
					Part #	Price/E
4"	4"	12"	8"	17"	FSGR440F	\$3951.85
	4½"	12"	8"	17"	FSGR445F	3951.85
	5"	12"	8"	17"	FSGR450F	3951.85
	6"	12"	8"	17"	FSGR460F	3951.85
5"	4"	12"	8"	17"	FSGR540F	3951.85
	5"	12"	8"	17"	FSGR550F	3951.85
	6"	12"	8"	17"	FSGR560F	3951.85



Female Swivel x Male

Male NST (NH)	(2)Female NST (NH) Swivel	Length	Width	Height	Aluminum Alloy, 356-T6	
					Part #	Price/E
4"	4"	12"	8"	17"	FMGR40F40F	\$3951.85
	4½"	12"	8"	17"	FMGR40F45F	2863.65
	5"	12"	8"	17"	FMGR40F50F	2863.65
	6"	12"	8"	17"	FMGR40F60F	3951.85
4½"	4"	12"	8"	17"	FMGR45F40F	3951.85
	4½"	12"	8"	17"	FMGR45F45F	3951.85
	5"	12"	8"	17"	FMGR45F50F	2863.65
	6"	12"	8"	17"	FMGR45F60F	3951.85
5"	4"	12"	8"	17"	FMGR50F40F	2978.20
	4½"	12"	8"	17"	FMGR50F45F	2978.20
	5"	12"	8"	17"	FMGR50F50F	3951.85
	6"	12"	8"	17"	FMGR50F60F	3951.85
6"	6"	12"	8"	17"	FMGR60F60F	3951.85



Replacement Parts

Description	Part #	Price/E
handwheel and knob	PV-HDWHL	\$255.00
knob only	PV-KNOB	177.75



PV-HDWHL

Butterfly Valves

Storz x Female Swivel

Valves

Features:

- permits safe controlled flow to the intake pump, can be used for draft situations
- pressure range: **150-300 PSI** working pressure at **70°F (21°C)**
- water way: 4½", 5", and 6" maximum
- materials: body-ASTN A-126 cast iron, wafer-lightweight aluminum cast 356-T6, , seat - Buna
- ¾" push-pull drain valve
- standard 10-position locking style lever
- finish anodized cast aluminum bolt flanges - minimum thickness 0.001"
- lever handle to center valve is 10¼"
- can be used in either direction (e.g. inlet/outlet)



Storz	Female NST (NH) Swivel	Length	Width	Height	ASTN A-126 Cast Iron	
					Part #	Price/E
4"	4"	9½"	11"	18"	SFBTFLY4040F	\$3234.80
	4½"	9½"	11"	18"	SFBTFLY4045F	3055.40
	5"	9½"	11"	18"	SFBTFLY4050F	3109.35
	6"	9½"	11"	18"	SFBTFLY4060F	2980.70
5"	4"	9½"	11"	18"	SFBTFLY5040F	3115.00
	4½"	9½"	11"	18"	SFBTFLY5045F	2945.00
	5"	9½"	11"	18"	SFBTFLY5050F	2997.10
	6"	9½"	11"	18"	SFBTFLY5060F	2868.50
6"	6"	9½"	13"	18"	SFBTFLY6060F	3016.40

L/H - Male x Female Swivel

Features:

- permits safe controlled flow to the intake pump, can be used for draft situations
- standard 10 position lever handle
- ¾" push-pull drain valve standard
- pressure range: **150-300 PSI** at **70°F (21°C)**
- water way: 4½", 5", and 6" maximum
- seat: Buna
- finish: anodized cast aluminum bolt flanges (minimum thickness 0.001")
- lever handle to center valve is 10¼", unit can be used in either direction e.g. inlet/outlet



Male NST (NH)	Female NST (NH) Swivel	Length	Width	Height	ASTN A-126 Cast Iron	
					Part #	Price/E
4"	4"	9½"	11"	18"	FMBTFLY40F40F	\$1920.50
4"	4½"	9½"	11"	18"	FMBTFLY40F45F	1920.50
4"	6"	9½"	11"	18"	FMBTFLY40F60F	2839.05
4½"	4½"	9½"	11"	18"	FMBTFLY45F45F	2561.65
5"	4½"	9½"	11"	18"	FMBTFLY50F45F	2809.40
5"	5"	9½"	11"	18"	FMBTFLY50F50F	2879.35
5"	6"	9½"	11"	18"	FMBTFLY50F60F	2731.05
6"	6"	9½"	13"	18"	FMBTFLY60F60F	2552.15

Single Clapper Siamese Connections

Features:

- single swing clapper with (2) pin lug swivel inlets
- provides 500 GPM minimum to supplement the fire protection as an auxiliary inlet connection to the water supply (250 GPM minimum per inlet)
- design provides unobstructed waterway
- exposed Fire Department Connections (FDC) provide an economical method of satisfying local fire codes
- branding: Auto-Sprkr
- finishes: -P polished or -C polished chrome plated
- maximum operating pressure: **250 PSI at 70°F (21°C)**
- replacement swivels can be ordered on page J-106

back outlet

Feature:

- UL listed and FM approved

Outlet Female NPT Thread	(2) Inlets Female Thread	Cast Brass	
		Part #	Price/E
4"	2½" NST (NH)	SCS4025F	\$539.25
4"	2½" NST (NH)	ISCS4025F ¹	224.25

¹ imported

Dimensions

Size	A	B	C
4" x 2½" x 2½"	5⅝"	9"	6-1/16"

- dimensions match SCS4025F and SCS4025NYFD

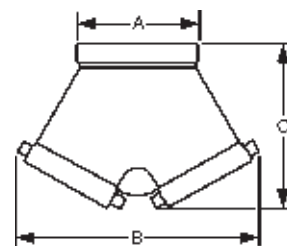

bottom outlet

Feature:

- UL listed

Outlet Female NPT Thread	(2) Inlets Female Thread	Cast Brass	
		Part #	Price/E
4"	2½" NST (NH)	90SCS4025F	\$657.20
4"	2½" NST (NH)	90ISCS4025F ¹	239.40

¹ imported

Dimensions

Size	A	B
4" x 2½" x 2½"	6⅞"	9⅞"

- dimensions match 90SCS4025F, and 90SCS4025NYFD

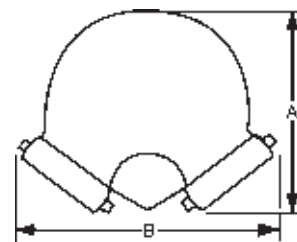



Double Clapper Siamese Connections

Features:

- double drop clapper with (2) pin lug swivel inlets provides required 500 GPM minimum to supplement the fire protection as an auxiliary inlet connection to the water supply (250 GPM minimum per inlet)
- exposed Fire Department Connections (FDC) provide an economical method of satisfying local fire codes
- maximum operating pressure: **175 PSI at 70°F (21°C)**
- finish: -P polished or -C polished chrome plated
- UL listed and FM approved

Valves

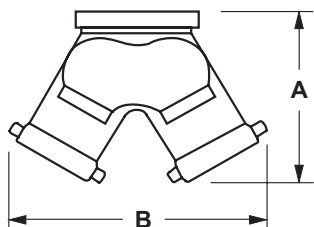

back outlet

Outlet Female NPT Thread	(2) Inlets Female Thread	Branding	Cast Brass	
			Part #	Price/E
4"	2½" NST(NH)	AutoSprinkler	DCS4025F	\$855.70
		AutoSprinkler	DCS4025F-P	969.70
		AutoSprinkler	DCS4025F-C	1036.40
		StandPipe	DCS4025F-SP	855.70
		No Branding	DCS4025F-NB	855.70
	3" NST(NH) 3" NYFD	AutoSprinkler	DCS4030F	878.80
		AutoSprinkler	DCS4030NYFD	878.80
6"	2½" NST(NH) 2½" NST(NH)	AutoSprinkler	DCS6025F	1018.50
		StandPipe	DCS6025F-SP	1018.50

Dimensions

Size	A	B
4" x 2½" x 2½"	9⅞"	12¼"
6" x 2½" x 2½"	10¼"	11¾"
4" x 3" x 3"	10"	12½"
6" x 3" x 3"	10⅝"	12½"

bottom outlet

Outlet Female NPT Thread	(2) Inlets Female Thread	Branding	Cast Brass	
			Part #	Price/E
4"	2½" NST(NH)	AutoSprinkler	90DCS4025F	\$847.10
		AutoSprinkler	90DCS4025F-P	968.35
		AutoSprinkler	90DCS4025F-C	998.65
		StandPipe	90DCS4025F-SP	847.10
		No Branding	90DCS4025F-NB	847.10
	3" NST(NH)	AutoSprinkler	90DCS4030F	940.00
6"	3" NYFD	AutoSprinkler	90DCS4030NYFD	940.00
		StandPipe	90DCS4030NYFDSP	940.00
		AutoSprinkler	90DCS6025F	892.20
6"	3" NYFD	StandPipe	90DCS6025F-SP	892.20
		AutoSprinkler	90DCS6030NYFD	2072.35

Dimensions

Size	A	B	C
4" x 2½" x 2½"	11¾"	9⅞"	7¼"
6" x 2½" x 2½"	11¾"	10¾"	7¼"
4" x 3" x 3"	12½"	10⅞"	7½"
6" x 3" x 3"	12¼"	10⅞"	7¼"

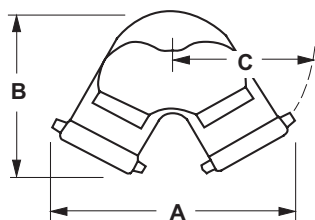

- special threads, branding and finishes are available, consult Dixon® for information
- replacement swivels can be ordered on page J-106

Triple Clapper Siamese Connections

Features:

- branding: see below
- finishes: -P polished or -C polished chrome plated
- maximum operating pressure: **175 PSI at 70°F (21°C)**

back outlet

Outlet Female NPT Thread	(3) Inlets Female NST (NH) Thread	Branding	Cast Brass	
			Part #	Price/E
4"	2½"	AutoSprinkler	TCS4025F	\$1833.40
		StandPipe	TCS4025F-SP	1833.40
		No Branding	TCS4025F-NB	1833.40
6"	2½"	AutoSprinkler	TCS6025F	2433.85
		StandPipe	TCS6025F-SP	2433.10
		No Branding	TCS6025F-NB	2176.00



polished

Valves

Dimensions

Size	A	B	C
4" x 2½" x 2½" x 2½"	13¾"	10½"	5"
6" x 2½" x 2½" x 2½"	13¾"	10½"	7½"

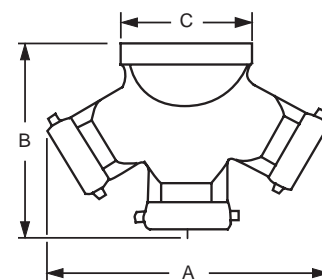

bottom outlet

Outlet Female NPT Thread	(3) Inlets Female NST (NH) Thread	Branding	Cast Brass	
			Part #	Price/E
4"	2½"	AutoSprinkler	90TCS4025F	\$2927.95
		No Branding	90TCS4025F-NB	2927.95
6"	2½"	AutoSprinkler	90TCS6025F	2788.65
		No Branding	90TCS6025F-NB	2788.65



Dimensions

Size	A	B	C
4" x 2½" x 2½" x 2½"	14½"	11½"	7⅝"
6" x 2½" x 2½" x 2½"	14½"	11½"	7⅝"

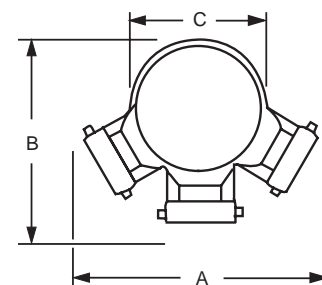

- special threads, branding and finishes are available, consult Dixon® for information
- replacement swivels can be ordered on page J-106



Reversible Concealed Angle **Siamese Body**



Valves

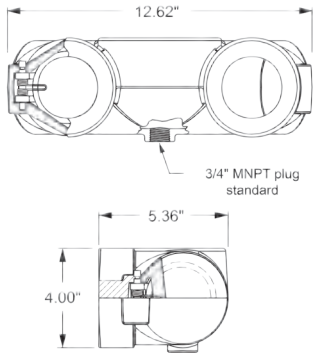

Features:

- fully reversible with a perpendicular trunnion allowing one body to be installed for top and bottom connections
- UL listed
- approved by New York City Board of Standards and Appeals
- maximum operating pressure: **250 PSI at 70°F (21°C)**
- bodies require wall plate **WP2** see page I-59

Outlet Female NPT Thread	(2) Inlets Female NPT Thread	Part #	Brass Price/E
4"	2½"	4025REV90	\$844.35
4"	3"	4030REV90	766.70

Reversible Concealed Angle **Siamese Body**

Features:

- fully reversible with a perpendicular trunnion allowing one body to be installed for top and bottom connections
- replaces 23-391 bodies
- maximum operating pressure: **250 PSI at 70°F (21°C)**



Outlet Female NPT Thread	(2) Inlets Female NPT Thread	Part #	Brass Price/E
5"	2½"	90CREV5025	\$1321.00
5"	3"	90CREV5030	1575.00
6"	2½"	90CREV6025	1321.00
6"	3"	90CREV6030	1321.00

Dimensions

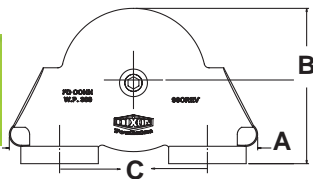

Size	A	B	C
5" x 3" x 3"	12"	9½"	7⅝"
6" x 2½" x 2½"	12"	7¼"	7⅝"
6" x 3" x 3"	12"	9½"	7⅝"



Concealed Two Way Wall Hydrant Body

Valves

Features:

- provides 500 GPM minimums at 250 GPM per inlet (ref NFPA 14)
- drop clappers provide unobstructed waterway
- flush design is desirable when appearance is a factor
- UL listed
- double clapper
- 7⁵/₈" center-line
- bodies require wall plate **WP2** (24-385), see page I-59

back outlet

Outlet Female NPT Thread	(2) Inlets Female NPT Thread	Brass	
		Part #	Price/E
4"	2½"	CDMHCB40225	\$803.95
4"	3"	CDMHCB40230	1135.95
5"	3"	CDMHCB50230	2190.95
6"	2½"	CDMHCB60225	918.70
6"	3"	CDMHCB60230	2909.15



Dimensions

Size	A	B	C
4" x 2½" x 2½"	11-1/8"	6"	7 ⁵ / ₈ "
4" x 3" x 3"	12-1/4"	8-1/8"	7 ⁵ / ₈ "
5" x 3" x 3"	11-13/16"	7-5/16"	7 ⁵ / ₈ "
6" x 2½" x 2½"	11-1/8"	7-3/8"	7 ⁵ / ₈ "
6" x 3" x 3"	12-1/4"	8-1/4"	7 ⁵ / ₈ "

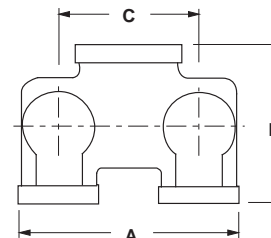

bottom outlet

Outlet Female NPT Thread	(2) Inlets Female NPT Thread	Brass	
		Part #	Price/E
5"	3"	90CDMHCB50230	\$3276.20
6"	2½"	90CDMHCB60225	3089.10
6"	3"	90CDMHCB60230	3087.20



Dimensions

Size	A	B	C
5" x 3" x 3"	12"	9½"	7 ⁵ / ₈ "
6" x 2½" x 2½"	12"	7¼"	7 ⁵ / ₈ "
6" x 3" x 3"	12"	9½"	7 ⁵ / ₈ "

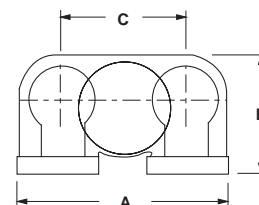

Spring Check Type Snoots - Pin Lug

Valves

Features:

- finishes: -P polished, -C polished chrome plated
- other configurations are also available, consult Dixon® for information
- maximum operating pressure: **175 PSI at 70°F (21°C)**

female outlet

Features:

- female NPT rigid with hexagon by female hose thread to swivel
- connections are attached to the bodies with pipe nipples (not included)



polished chrome plated

Outlet Female NPT Thread	Inlet Female NST (NH) Thread	Cast Brass	
		Part #	Price/E
3"	2½"	CSSTF25F30T-P	\$490.35
3"	2½"	CSSTF25F30T-C	630.95
3"	3"	CSSTF30F30T-P	542.45

Dimensions

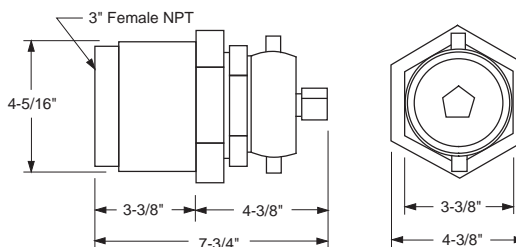

male outlet

Features:

- finishes: -P polished, -C polished chrome plated
- male NPT x 2½" female hose thread to swivel
- used when a direct connection to bodies is desired



polished

Outlet Male NPT Thread	Inlet Female NST (NH) Thread	Cast Brass	
		Part #	Price/E
3"	2½"	CSSTM25F30T-P	\$527.20
	2½"	CSSTM25F30T-C	567.65
	3"	CSSTM30F30T-P	534.75
	3"	CSSTM30F30T-C	567.55

Dimensions

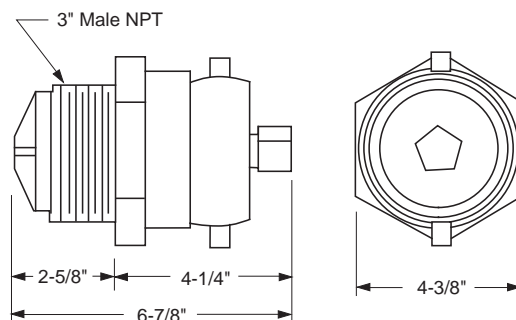

- Under no circumstances should a check snoot be installed directly into a pipe, as this may prevent the snoot from opening. Install directly into the appropriate standpipe body only.



Clapper Type Snoots - Pin Lug



Features:

- finishes: -P polished, -C polished chrome plated
- other sizes and threads are available, consult Dixon® for information

Outlet Female NPT Thread	Inlet Female NST (NH) Thread	Cast Brass	
		Part #	Price/E
3"	2½"	CSCTF25F30T-P	\$270.05
3"	2½"	CSCTF25F30T-C	282.40

Outlet Male NPT	Inlet Female NST (NH)	Cast Brass	
		Part #	Price/E
3"	2½"	CSCTM25F30T-P	\$270.05
3"	2½"	CSCTM25F30T-C	282.40



polished chrome plated



polished

Valves

Wall Plate for Double Clapper Siamese Assemblies

Features:

- finishes: -P polished, -C polished chrome plated
- 4-hole and 6-hole wall plates available, consult Dixon® for information

Hole Size	Branding	Brass	
		Part #	Price/E
3⅜"	AutoSprinkler	WP2HAS-P	\$240.90
	AutoSprinkler	WP2HAS-C	287.15
	StandPipe	WP2HSP-P	240.90
	StandPipe	WP2HSP-C	287.15
	AutoSprinkler StandPipe Combo	WP2H-ASSP-P	240.90
	AutoSprinkler StandPipe Combo	WP2H-ASSP-C	287.15
	Hydrant	WP2H-HY-P	240.95
	PumpTest	WP2H-PT-P	240.90
	PumpTest	WP2H-PT-C	287.15



Dimensions

Hole Size	A	B	C	D
3⅜"	14"	8"	7⅝"	4-15/16"

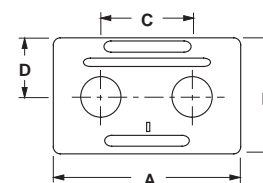

Wall Plate for Concealed Three Way Bodies

Features:

- finishes: -P polished, -C polished chrome plated
- 4-hole and 6-hole wall plates available, consult Dixon® for information

Hole Size	Positioned	Branding	Brass	
			Part #	Price/E
3⅝"	Horizontal	AutoSprinkler	WP3HAS-P	\$377.30
	Horizontal	AutoSprinkler	WP3HAS-C	446.10
	Horizontal	StandPipe	WP3HSP-P	377.30
	Horizontal	StandPipe	WP3HSP-C	446.10



Dimensions

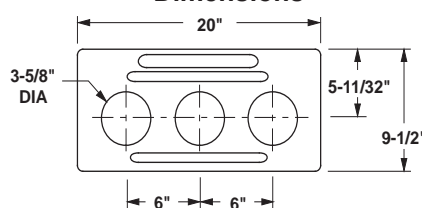

ULC UL FM Double Clapper Concealed Type Siamese Assemblies

Valves



Features:

- fully reversible with a perpendicular trunnion allowing one body to be installed for top and bottom connections
- branded: 'standpipe', 'auto-sprkr', 'auto-sprkr.-standpipe'
- finishes: -P polished or -C polished chrome plated
- maximum operating pressure: **250 PSI**
- complete unit consisting of the following six parts: (1) 4025REV90, or 4030REV90, or 90CREV6025, (1) 24-385 plate, (2) 23-270 double female connections, (2) 17-127 plugs with chains

Outlet Female NPT Thread	(2) Inlets Female NST (NH) Thread	Branding	Cast Brass	
			Part #	Price/E
4"	2½"	AutoSprinkler	2WCA4025F-P	\$1494.45
4"	2½"	StandPipe	2WCA4025F-SP-P	1494.45
4"	2½"	AutoSprinkler	2WCA4025F-C	1564.00
4"	2½"	StandPipe	2WCA4025F-SP-C	1564.00
4"	3"	AutoSprinkler	2WCA4030F-P	1897.85
6"	2½"	AutoSprinkler	2WCA6025F-P	1971.10
6"	2½"	StandPipe	2WCA6025F-SP-P	1971.10
6"	2½"	AutoSprinkler	2WCA6025F-C	2040.65
6"	2½"	StandPipe	2WCA6025F-SP-C	2040.65

- other branding and finishes are also available, consult Dixon® for information

ULC UL FM

Two Way Sidewalk Siamese Assemblies

Features:

- UL listed, FM approved
- finishes: -P polished or -C polished chrome plated
- complete unit consists of: (1) 21-133 90° Siamese body, double clapper, (2) 17-127 pin lug plugs with chains, (1) 23-404 sleeve, (1) 24-405 escutcheon plate



Outlet Female NPT Thread	(2) Inlets Female Thread	Cast Brass	
		Part #	Price/E
4"	2½"	2WSA4025F	\$1729.65
4"	2½"	2WSA4025F-SP	1729.65
6"	2½"	2WSA6025F	1824.35
6"	2½"	2WSA6025F-SP	1824.35

Dimensions

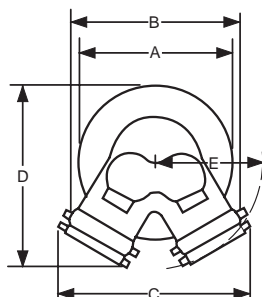

Size	A	B	C	E	F
4" x 2½" x 2½"	9¼"	10⅝"	10¾"	10⅝"	6⅝"
6" x 2½" x 2½"	11¼"	10½"	11¾"	13"	7¼"

Note: some components UL listed/FM approved, not entire assembly

Single Inlet Residential Sprinkler Connections

Application:

- complete single inlet connection (exposed type) used on residential automatic sprinkler systems

Features:

- complete unit consists of: (1) 17-127 1½" pin lug plug with chain and (1) 24-209 4-7/16" OD round escutcheon plate with swivel



Inlet Female NST (NH) Thread	Outlet Female NPT Thread	Cast Brass	
		Part #	Price/E
1½"	1½"	RIC150F	\$77.70

Single Inlet Connections

Features:

- provides a complete exposed single inlet connection
- finish: -P polished or -C polished chrome plated
- complete unit consists of: (1) 24-209 round plate branded Auto Sprinkler, (1) 23-270 double female or 09-215 male and female connection, (1) 17-127 pin lug plug with chain
- rigid hexagon end of either connection is 2½" NPT
- swivel end



Inlet Female NST (NH) Thread	Outlet Female NPT Thread	Brass	
		Part #	Price/E
2½"	2½"	SIC250F	\$256.00
2½"	2½"	SIC250F-P	268.30
2½"	2½"	SIC250F-C	327.85

Single Hydrant Connections

Features:

- finish: -P polished or -C polished chrome plated
- complete unit consists of: (1) 24-209 round plate branded 'Wall Hydrant', (1) 23-272: 2½" female and male connection, (1) 17-126 cap with chain



Inlet Female NPT Thread	Outlet Male NST (NH) Thread	Cast Brass	
		Part #	Price/E
2½"	2½"	MOCA250F	\$722.00

Exposed Two Way Wall Hydrants

Features:

- finish: -P polished or -C polished chrome plated
- DMOCA40225F consists of: (1) REP400HY round plate branded 'Wall Hydrant', (1) FRC4025F: 2½" female and male connection, (2) FC250F cap with chain
- DMOCA60225F consists of: (1) REP600HY round plate branded 'Wall Hydrant' (1) FRC6025F: 2½" female and male connection, (2) FC250F cap with chain



Inlet Female NPT Thread	(2) Outlets Male NST (NH) Thread	Cast Brass	
		Part #	Price/E
4"	2½"	DMOCA40225F	\$689.65
6"	2½"	DMOCA60225F	952.50

2-Way 3 Piece Encapsulated Ball Valves

Valves



Features:

- balanced encapsulated construction minimizes cold flow
- live-loaded stem packing
- precision stainless steel balls reduce torque and friction losses while extending seat life
- lockable handle can prevent accidental actuation
- standard internal entry blow out proof stem design
- full port design matches ball and seat ports to tube ID for lower pressure drop and less turbulent flow
- compact design for areas with tight space restrictions
- fully encapsulated construction produces bubble tight seal
- integral ISO 5211 mounting pad
- ID polish: Ra 32 minimum
- CF8M stainless body, ends and ball
- ½" - 2" rated at **1,000 PSI WOG**; 2½" - 4" rated at 800 PSI WOG
- virgin PTFE seats
- for valve seat options, call Dixon®
- identification tagging available
- repair kits available

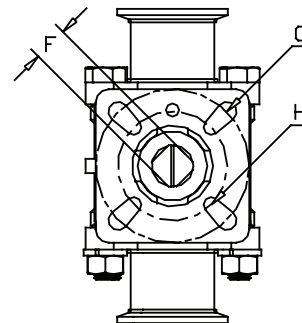
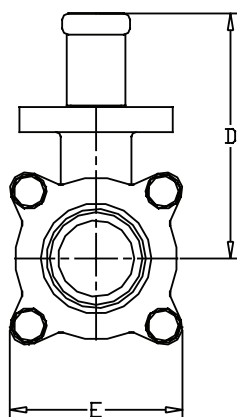
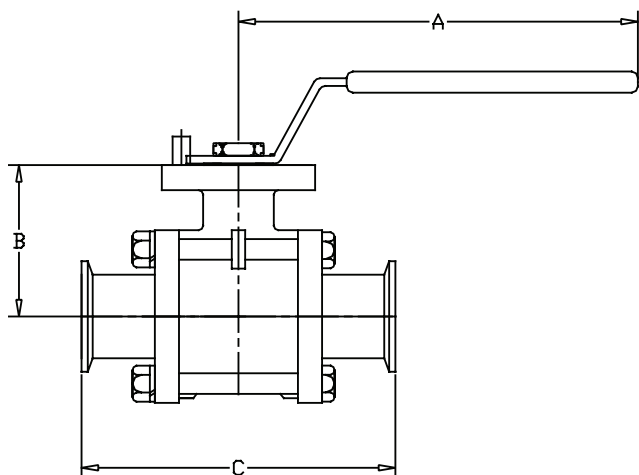

Size	Dimensions								316 Stainless Steel	
	A	B	C	D	E	F (mm)	G	H	Part #	Price/E
½"	4.9"	1.5"	4.3"	3.0"	1.9"	9.0	F04	F03	BV2CV-050CC-A	\$165.98
¾"	4.9"	1.8"	4.7"	3.3"	2.2"	9.0	F04	F03	BV2CV-075CC-A	200.47
1"	5.6"	2.1"	4.9"	3.6"	2.4"	11.0	F05	F04	BV2CV-100CC-A	262.81
1½"	9.5"	2.7"	5.6"	4.4"	3.1"	14.0	F07	F05	BV2CV-150CC-A	443.20
2"	9.5"	3.1"	6.4"	4.8"	3.7"	14.0	F07	F05	BV2CV-200CC-A	641.13
2½"	18.0"	3.8"	7.8"	5.2"	4.8"	17.0	F10	F07	BV2CV-250CC-A	1338.79
3"	18.0"	4.2"	9.0"	5.7"	5.4"	17.0	F10	F07	BV2CV-300CC-A	1767.33
4"	18.0"	5.3"	9.5"	6.8"	8.8"	22.0	F12	F10	BV2CV-400CC-A	3036.48

Our commitment to excellence and continuous research and development for improving product quality may warrant periodic changes in design and specification. We reserve the right to modify product design without prior notification and without incurring any liability to provide these modifications to products previously purchased.

Non-Encapsulated **2-way 3 Piece Stainless Steel** Ball Valves**Features:**

- blow-out proof stem
- live-loaded stem packing
- lockable handle
- 15% glass reinforced PTFE seats
- ID polish is R_a 32
- CF8M stainless body, ends and ball
- pressure ratings: ½" - 2" **1,000 PSI WOG**
2½" - 4" **800 PSI WOG**
- repair kits available
- for valve seat options, call Dixon®



Valves

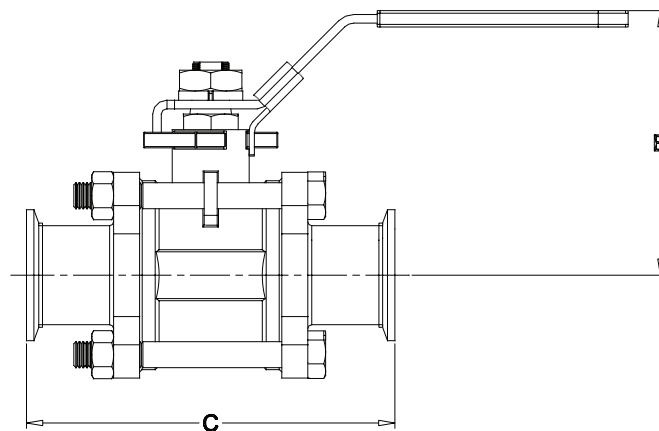
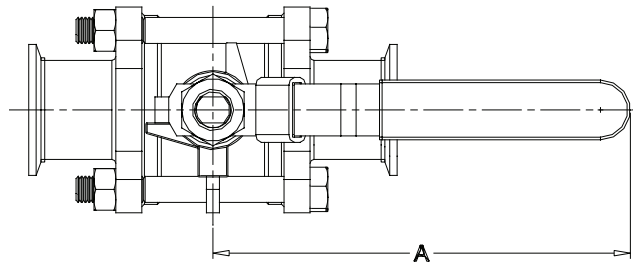

Size	Dimensions			Break Torque (in-lbs.)	Weight (lbs.)	316 Stainless Steel	
	A	B	C			Part #	Price/E
½"	4.1"	2.3"	4.6"	55	1.4	BV2GG-050CC-A	\$119.94
¾"	4.1"	2.5"	4.7"	71	1.8	BV2GG-075CC-A	130.91
1"	5.0"	2.8"	4.9"	101	2.6	BV2GG-100CC-A	192.93
1½"	6.1"	3.5"	5.6"	221	4.6	BV2GG-150CC-A	326.96
2"	7.6"	3.9"	6.4"	345	8.5	BV2GG-200CC-A	492.69
2½"	7.6"	4.4"	7.8"	883	17.8	BV2GG-250CC-A	873.15
3"	10.9"	4.9"	9.0"	830	28.2	BV2GG-300CC-A	1426.38
4"	13.2"	6.6"	9.6"	1323	41.4	BV2GG-400CC-A	2554.53

Dimensions are approximate. Engineering dimensions are available upon request. Specifications are subject to change without notice.

Butterfly Valves

Features:

- available with three handle options:
 - The *pull style handle* allows you to set the valve in four different positions simply by pulling and turning.
 - The *infinite handle* has incremental marks on the top which can be used when needing a throttling valve.
 - The *trigger handle* offers twelve positions which make it easy to understand how to actuate the valve.
- Handle is not assembled when shipped. To order with handle assembled on the valve please request assembly in the special instructions of your order.
- 100% hydraulic tested / 100% inspected
- all wetted surfaces are sanitary finished to < 32R_a
- field serviceable (no special tools required)
- various end configurations available: weld, I-line, Q-line, bevel seat and John Perry
- actuation available: double-acting, air-to-spring, electric, call Dixon® for details
- vacuum rating: 0.4 inches Hg at 68°F
- temperature range: 15°F to 200°F (-9°C to 93°C)
- clamp style is standard

Valves



Clamp End Butterfly Valve with Pull Handle - [A]

Size	316L Stainless Steel with Silicone Seats		316L Stainless Steel with FKM Seats		316L Stainless Steel with EPDM Seats	
	Part #	Price/E	Part #	Price/E	Part #	Price/E
½"	B5101S050CC-A	\$317.53	B5101V050CC-A	\$343.34	B5101E050CC-A	\$311.80
¾"	B5101S075CC-A	317.53	B5101V075CC-A	343.34	B5101E075CC-A	311.80
1"	B5101S100CC-A	298.36	B5101V100CC-A	324.17	B5101E100CC-A	292.63
1½"	B5101S150CC-A	289.19	B5101V150CC-A	335.64	B5101E150CC-A	282.39
2"	B5101S200CC-A	356.53	B5101V200CC-A	414.04	B5101E200CC-A	345.14
2½"	B5101S250CC-A	437.31	B5101V250CC-A	564.53	B5101E250CC-A	423.71
3"	B5101S300CC-A	595.42	B5101V300CC-A	824.39	B5101E300CC-A	576.98
4" ¹	B5101S400CC-A	962.02	B5101V400CC-A	1395.72	B5101E400CC-A	900.58
6"	B5101S600CC-A	1997.86	---	---	B5101E600CC-A	2085.76
8"	---	---	---	---	B5101E800CC-A	4813.34

¹ 4" high pressure butterfly valve is available, call Dixon® for more information

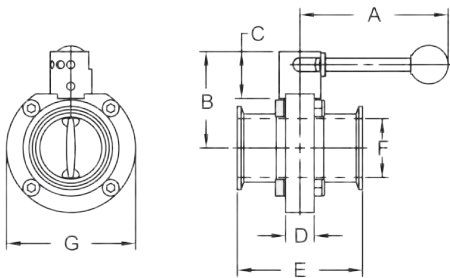

Size	Dimensions							Break Torque (in. lbs.) Silicone	Break Torque (in. lbs.) FKM	Break Torque (in. lbs.) EPDM	PSI @ 68°F
	A	B	C	D	E	F	G				
½"	4.4"	2.8"	1.4"	0.9"	3.5"	.37"	3.1"	20	70	75	140
¾"	4.4"	2.8"	1.4"	0.9"	3.5"	.62"	3.1"	20	70	75	140
1"	4.4"	2.8"	1.4"	0.9"	3.5"	0.9"	3.1"	20	70	75	140
1½"	4.4"	2.8"	1.4"	0.9"	3.5"	1.4"	3.1"	40	125	130	140
2"	4.4"	3.1"	1.4"	0.9"	3.8"	1.9"	3.9"	55	175	165	140
2½"	4.4"	3.5"	1.4"	0.9"	3.8"	2.4"	4.6"	70	220	210	110
3"	6.2"	3.8"	1.3"	1.2"	4.1"	2.9"	5.2"	165	310	350	110
4"	6.2"	4.5"	1.3"	1.2"	4.8"	3.8"	6.7"	350	450	540	85
6"	11.5"	5.5"	1.3"	1.2"	5.5"	5.8"	8.5"	700	n/a	1550	60
8"	18.0"	6.9"	1.6"	1.2"	4.9"	7.8"	11.2"	n/a	n/a	1650	60

Clamp End Butterfly Valves with Infinite Position Handle - [B]



Size	316L Stainless Steel with Silicone Seats		316L Stainless Steel with FKM Seats		316L Stainless Steel with EPDM Seats	
	Part #	Price/E	Part #	Price/E	Part #	Price/E
½"	B5101S050CC-B	\$317.53	B5101V050CC-B	\$343.34	B5101E050CC-B	\$311.82
¾"	B5101S075CC-B	317.53	B5101V075CC-B	343.34	B5101E075CC-B	311.82
1"	B5101S100CC-B	298.36	B5101V100CC-B	324.15	B5101E100CC-B	292.61
1½"	B5101S150CC-B	289.19	B5101V150CC-B	335.64	B5101E150CC-B	282.39
2"	B5101S200CC-B	356.53	B5101V200CC-B	414.04	B5101E200CC-B	345.14
2½"	B5101S250CC-B	437.31	B5101V250CC-B	564.53	B5101E250CC-B	423.71
3"	B5101S300CC-B	595.42	B5101V300CC-B	824.39	B5101E300CC-B	576.98
4"	B5101S400CC-B	962.02	B5101V400CC-B	1395.23	B5101E400CC-B	900.58

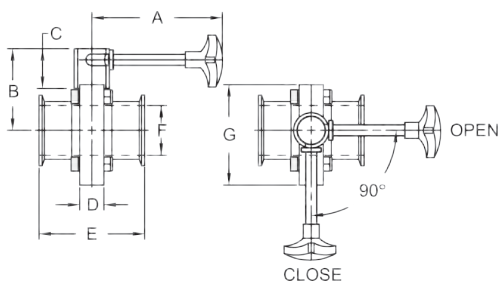

Size	Dimensions							Break Torque (in. lbs.) Silicone	Break Torque (in. lbs.) FKM	Break Torque (in. lbs.) EPDM	PSI @ 68°F
	A	B	C	D	E	F	G				
½"	4.3"	2.6"	1.3"	0.9"	3.5"	.37"	3.1"	20	70	75	140
¾"	4.3"	2.6"	1.3"	0.9"	3.5"	.62"	3.1"	20	70	75	140
1"	4.3"	2.6"	1.3"	0.9"	3.5"	0.9"	3.1"	20	70	75	140
1½"	4.3"	2.6"	1.3"	0.9"	3.5"	1.4"	3.1"	40	125	130	140
2"	4.3"	2.9"	1.3"	0.9"	3.8"	1.9"	3.9"	55	175	165	140
2½"	4.3"	3.3"	1.3"	0.9"	3.8"	2.4"	4.6"	70	220	210	110
3"	6.4"	3.6"	1.3"	1.2"	4.1"	2.9"	5.2"	165	310	350	110
4"	6.4"	4.4"	1.3"	1.2"	4.8"	3.8"	6.7"	350	450	540	85

Butterfly Valves

Clamp End Butterfly Valve with Trigger Handle - [C]

Features:

- lockout / tagout handle
- Handle is not assembled when shipped. To order with handle assembled on the valve please request assembly in the special instructions of your order.

Size	316L Stainless Steel with Silicone Seats		316L Stainless Steel with FKM Seats		316L Stainless Steel with EPDM Seats	
	Part #	Price/E	Part #	Price/E	Part #	Price/E
1/2"	B5101S050CC-C	\$317.53	B5101V050CC-C	\$343.34	B5101E050CC-C	\$311.80
3/4"	B5101S075CC-C	317.53	B5101V075CC-C	343.34	B5101E075CC-C	311.80
1"	B5101S100CC-C	298.36	B5101V100CC-C	324.17	B5101E100CC-C	292.63
1 1/2"	B5101S150CC-C	289.19	B5101V150CC-C	335.64	B5101E150CC-C	282.39
2"	B5101S200CC-C	356.53	B5101V200CC-C	414.04	B5101E200CC-C	345.14
2 1/2"	B5101S250CC-C	437.31	B5101V250CC-C	564.53	B5101E250CC-C	423.71
3"	B5101S300CC-C	595.42	B5101V300CC-C	824.39	B5101E300CC-C	576.98
4"	B5101S400CC-C	962.02	B5101V400CC-C	1395.72	B5101E400CC-C	900.58



Valves

Size	Dimensions							Break Torque (in. lbs.) silicone	Break Torque (in. lbs.) FKM	Break Torque (in. lbs.) EPDM	PSI @ 68°F
	A	B	C	D	E	F	G				
1/2"	6.6"	3.0"	1.7"	0.9"	3.5"	.37"	3.1"	20	70	75	140
3/4"	6.6"	3.0"	1.7"	0.9"	3.5"	.62"	3.1"	20	70	75	140
1"	6.6"	3.0"	1.7"	0.9"	3.5"	0.9"	3.1"	20	70	75	140
1 1/2"	6.6"	3.0"	1.7"	0.9"	3.5"	1.4"	3.1"	40	125	130	140
2"	6.6"	3.5"	1.7"	0.9"	3.8"	1.9"	3.9"	55	175	165	140
2 1/2"	6.6"	3.7"	1.7"	0.9"	3.8"	2.4"	4.6"	70	220	210	110
3"	6.6"	3.9"	1.7"	1.2"	4.1"	2.9"	5.2"	165	310	350	110
4"	6.6"	4.8"	1.7"	1.2"	4.8"	3.8"	6.7"	350	450	540	85

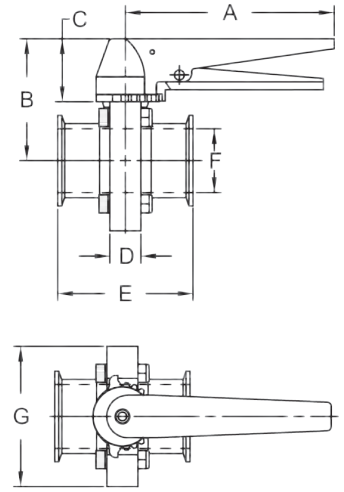

Repair Kits for Butterfly Valves

Features:

Repair kit contains:

- (1) seat
- (2) bushings

for valves located on pages I-64 and I-65

Valve Size	Black EPDM		Red Silicone		Brown FKM	
	Part #	Price/E	Part #	Price/E	Part #	Price/E
1/2" - 1"	B5101-RKE100	\$18.02	B5101-RKS100	\$25.33	B5101-RKV100	\$57.90
1 1/2"	B5101-RKE150	19.43	B5101-RKS150	29.41	B5101-RKV150	80.09
2"	B5101-RKE200	23.59	B5101-RKS200	32.31	B5101-RKV200	105.01
2 1/2"	B5101-RKE250	26.49	B5101-RKS250	36.06	B5101-RKV250	196.81
3"	B5101-RKE300	42.62	B5101-RKS300	57.07	B5101-RKV300	346.35
4"	B5101-RKE400	64.88	B5101-RKS400	88.15	B5101-RKV400	636.28
6"	B5101-RKE600	103.09	B5101-RKS600	217.33	---	---
8"	B5101-RKE800	326.50	---	---	---	---



Our commitment to excellence and continuous research and development for improving product quality may warrant periodic changes in design and specification. We reserve the right to modify product design without prior notification and without incurring any liability to provide these modifications to products previously purchased.

Butterfly Valves

Clamp Butterfly Valves

Features:

- minimal line pressure: 0.4 inches Hg vacuum @ **68°F (20°C)**
- temperature range: **15°F - 200°F (-9C to 93°C)**
- PTFE valve disc bushings decrease friction and increase cycle life
- valve is only 1 3/8" wide on all sizes and uses only 3/4" of the space
- 3 position reversible handle
- the grooved clamp housing connects directly to the corresponding sanitary clamp size
- easy assembly requires a hex key for the handle and wing nuts to secure and seal the housing onto lines
- can be modified for lockout/tagout
- actuation available: double acting, spring return and electric, call Dixon® for details

Information supplied based on water media @ **68°F (20°C)**

Size	Break Torque (in-lbs.)	Assembly Torque (in-lbs.)	Pressure Rating (PSI)	Flow Coefficient (C _v)	Weight w/standard handle (lbs.)
1"	125	36	140	23	1.5
1 1/2"	185	36	140	80	2
2"	200	21.6	120	230	2.5
2 1/2"	260	21.6	120	264	3
3"	350	28.8	100	372	4
4"	495	43.2	70	800	6



Size	316L Stainless Steel with Silicone Seats		316L Stainless Steel with FKM Seats		316L Stainless Steel with EPDM Seats	
	Part #	Price/E	Part #	Price/E	Part #	Price/E
1"	B5102S100-A	\$197.12	B5102V100-A	\$242.28	B5102E100-A	\$197.12
1 1/2"	B5102S150-A	197.12	B5102V150-A	239.49	B5102E150-A	197.12
2"	B5102S200-A	239.26	B5102V200-A	293.10	B5102E200-A	239.26
2 1/2"	B5102S250-A	309.88	B5102V250-A	375.44	B5102E250-A	309.88
3"	B5102S300-A	366.15	B5102V300-A	436.98	B5102E300-A	366.15
4"	B5102S400-A	534.11	B5102V400-A	635.54	B5102E400-A	534.11

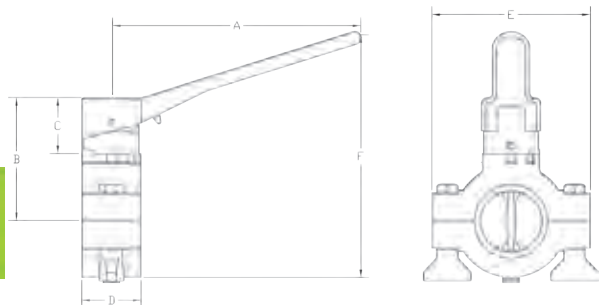

Size	Dimensions						Break Torque (inch lbs.)	PSI @ 68°F (20°C)
	A	B	C	D	E	F		
1"	5.6"	2.8"	1.3"	1.3"	3.6"	5.6"	125	140
1 1/2"	5.6"	2.8"	1.3"	1.3"	3.6"	5.6"	185	140
2"	5.6"	3.0"	1.3"	1.3"	4.1"	6.1"	200	120
2 1/2"	5.6"	3.3"	1.3"	1.3"	4.6"	6.6"	260	120
3"	5.6"	3.6"	1.3"	1.3"	5.3"	7.1"	350	100
4"	5.6"	4.1"	1.3"	1.3"	6.4"	8.2"	495	70

Repair Kits for Clamp Butterfly Valves

Repair kit contains:

- (1) seat
- (2) bushings



B5102-RKS100

Valve Size	Black EPDM		Red Silicone		Brown FKM	
	Part #	Price/E	Part #	Price/E	Part #	Price/E
1"	B5102-RKE100	\$22.51	B5102-RKS100	\$22.51	B5102-RKV100	\$77.43
1 1/2"	B5102-RKE150	16.16	B5102-RKS150	17.78	B5102-RKV150	69.54
2"	B5102-RKE200	24.43	B5102-RKS200	24.43	B5102-RKV200	88.31
2 1/2"	B5102-RKE250	29.16	B5102-RKS250	29.16	B5102-RKV250	107.09
3"	B5102-RKE300	65.55	B5102-RKS300	65.55	B5102-RKV300	158.34
4"	B5102-RKE400	82.17	B5102-RKS400	82.17	B5102-RKV400	208.45

Butterfly Valve Automation

Butterfly Valve with Stainless Steel Vertical Spring Return Actuation

Features:

- silicone and FKM elastomers also available
- other end configurations are available
- contact Dixon® for more information

Butterfly Valve with EPDM seats and a vertical spring return normally closed pneumatic canister style actuator

Valve Size	Style B5101	
	Part #	Price/E
½"	<i>B5101E050CC-G</i>	\$1034.83
¾"	<i>B5101E075CC-G</i>	1034.83
1"	<i>B5101E100CC-G</i>	1102.81
1½"	<i>B5101E150CC-G</i>	1028.29
2"	<i>B5101E200CC-G</i>	1161.07
2½"	<i>B5101E250CC-G</i>	1221.62
3"	<i>B5101E300CC-G</i>	1261.11
4"	<i>B5101E400CC-G</i>	1579.85

Butterfly Valve with EPDM seats and a vertical spring return normally open pneumatic canister style actuator

Valve Size	Style B5101	
	Part #	Price/E
½"	<i>B5101E050CC-F</i>	\$1034.83
¾"	<i>B5101E075CC-F</i>	1034.83
1"	<i>B5101E100CC-F</i>	1033.14
1½"	<i>B5101E150CC-F</i>	1020.74
2"	<i>B5101E200CC-F</i>	1134.83
2½"	<i>B5101E250CC-F</i>	1192.76
3"	<i>B5101E300CC-F</i>	1383.48
4"	<i>B5101E400CC-F</i>	1821.72

Butterfly Valve with EPDM seats and a vertical double acting pneumatic canister style actuator

Valve Size	Style B5101	
	Part #	Price/E
½"	<i>B5101E050CC-H</i>	\$1034.83
¾"	<i>B5101E075CC-H</i>	1034.83
1"	<i>B5101E100CC-H</i>	1102.81
1½"	<i>B5101E150CC-H</i>	1063.24
2"	<i>B5101E200CC-H</i>	1133.43
2½"	<i>B5101E250CC-H</i>	1191.22
3"	<i>B5101E300CC-H</i>	1228.51
4"	<i>B5101E400CC-H</i>	1784.42



Spring Check Valves

3
1447 58-00

Valves

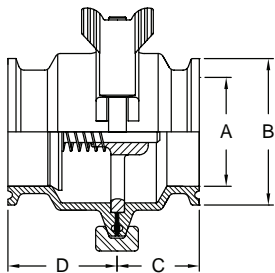
**Features:**

- 3A authorized 58-00
- full size flow plate
- long stem bushing for increased cycle life
- suitable for low and medium viscosity fluids
- field serviceable (no special tools required)
- operating temperature range: **15°F to 200°F (-9°C to 93°C)**
- maximum operating pressure: **145 PSI**
- various end connections available, contact Dixon® for information

Size	Dimensions				316L Stainless Steel	
	A	B	C	D	Part #	Price/E
½"	0.37"	0.99"	1.10"	1.60"	B45MP-R50	\$396.20
¾"	0.62"	0.99"	1.10"	1.60"	B45MP-R75	442.99
1"	0.87"	1.99"	1.37"	1.92"	B46MP-R100	447.84
1½"	1.37"	1.99"	1.44"	1.92"	B46MP-R150	382.09
2"	1.87"	2.52"	1.44"	1.92"	B46MP-R200	512.85
2½"	2.37"	3.05"	1.44"	1.92"	B46MP-R250	727.27
3"	2.87"	3.58"	1.44"	1.92"	B46MP-R300	964.94
4"	3.84"	4.69"	1.88"	2.15"	B46MP-R400	1132.48

Repair Kits for Spring Check Valves

Repair kit for ½" - ¾" contains:

- (1) 316L spring
- (1) FKM stem seat
- (1) EPDM body O-ring

Repair kit for 1" - 4" contains:

- (1) 316L spring
- (1) FKM stem seat
- (1) EPDM clamp gasket



Size	Part #	Price/E
½"	B45MP-RK050	\$11.39
¾"	B45MP-RK075	13.45
1"	B46MP-RK100	16.20
1½"	B46MP-RK150	17.24
2"	B46MP-RK200	21.59
2½"	B46MP-RK250	26.79
3"	B46MP-RK300	29.59
4"	B46MP-RK400	49.74

Y Ball Check Valves

3
1447

When liquid flows through the valve, the ball is forced into the branch of the valve allowing full fluid flow. When the liquid stops, equalizing the pressure, the ball drops back into the seat, preventing backflow. Should reverse flow occur, the differential pressure will cause the ball to seal firmly against the seat preventing leakage.

Features:

- maximum operating pressure: **150 PSI**
- temperature range: **15° to 200°F (-9°C to 93°C)**
- two piece construction for easier alignment during installation
- ID and OD polished to 3A standards
- all metal contact surfaces of 316L stainless steel construction
- PTFE ball
- replaceable seat
- field serviceable without special tools
- various end configurations available: clamp, weld, I-line, Q-line, bevel seat and John Perry
- air blow check valve can be added (see air blow for sizing)



Valves

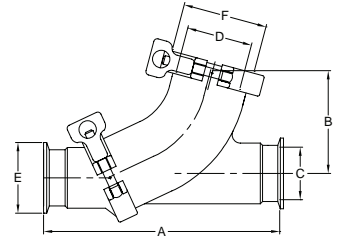

Size	Dimensions						316L Stainless Steel	
	A	B	C	D	E	F	Part #	Price/E
1½"	7.50"	3.30"	1.36"	1.87"	1.98"	2.51"	B45BY-R150	\$713.39
2"	8.50"	3.90"	1.86"	2.33"	2.51"	3.04"	B45BY-R200	938.61
2½"	10.00"	4.50"	2.37"	2.87"	3.04"	3.57"	B45BY-R250	1252.72
3"	11.50"	5.30"	2.87"	3.83"	3.57"	4.68"	B45BY-R300	2047.54

Repair Kits

Size	Part #	Price/E
1½"	B45BY-RK150	\$106.76
2"	B45BY-RK200	164.26
2½"	B45BY-RK250	339.87
3"	B45BY-RK300	766.51

repair kit contains:

- (1) PTFE ball
- (1) EPDM/CF8M seat
- (1) EPDM cap gasket

Seal Kits

Size	Part #	Price/E
1½"	B45BY-SK150	\$28.38
2"	B45BY-SK200	36.93
2½"	B45BY-SK250	48.86
3"	B45BY-SK300	76.12

seal kit contains:

- (1) EPDM/CF8M seat
- (1) EPDM cap gasket

All FKM Seal Kits

Size	Part #	Price/E
1½"	B45BY-SKV150	\$87.89
2"	B45BY-SKV200	89.97
2½"	B45BY-SKV250	116.35
3"	B45BY-SKV300	180.89

FKM seal kit contains:

- (1) FKM/CF8M seat
- (1) FKM cap gasket

Replacement Balls

Size	Part #	Price/E
1½"	B45BY-TB150	\$85.35
2"	B45BY-TB200	127.26
2½"	B45BY-TB250	290.99
3"	B45BY-TB300	620.21

(1) PTFE Ball

Air Blow Check Valves

3
1447 58-00

Valves

Applications:

- The air blow check valve is designed to pressurize lines with air to clean out product or cleaning solutions. It is fail-safe because the simple air-to-open, spring-to-close mechanism prevents backflow. Can be used with a check valve.

Features:

- EPDM stem seat and gasket
- conforms to 3A practice 604-05 with optional filter disc, sold separately in packs of 50
- maximum temperature: **212°F (100°C)**
- maximum operating pressure: **145 PSI**

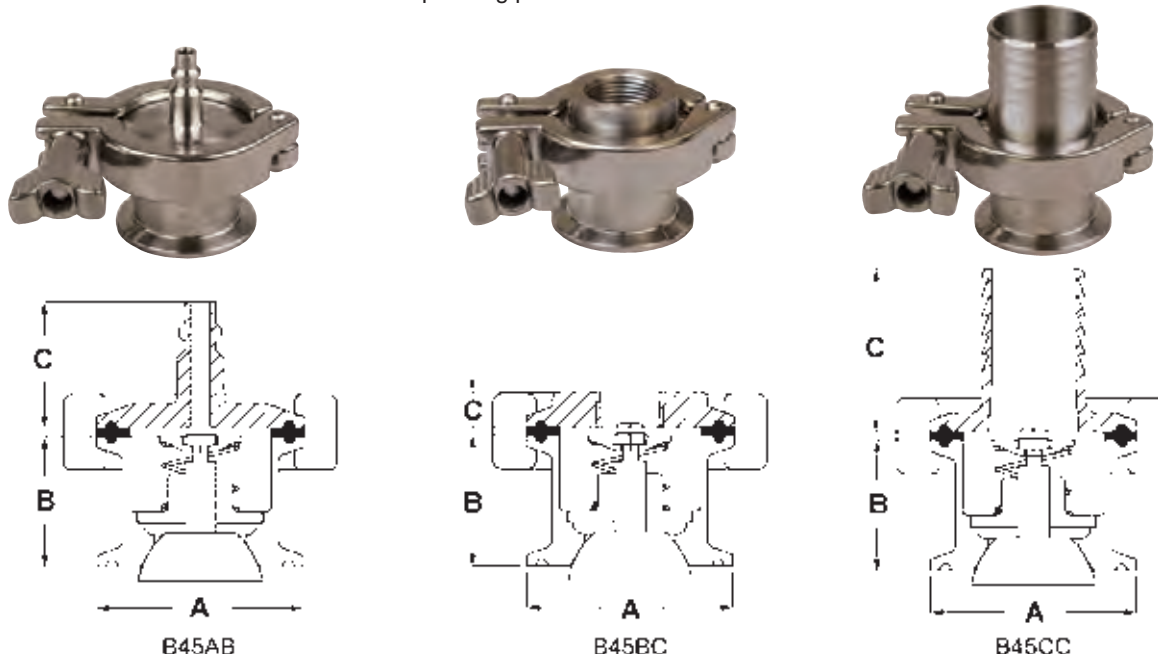

Size	Dimensions		Quick Connect Plug 316L Stainless Steel		Dim. C	Female NPT 316L Stainless Steel		Dim. C	Hose Barb 316L Stainless Steel		Dim. C
	A	B	Part #	Price/E		Part #	Price/E		Part #	Price/E	
1"-1½"	1.984"	1.300"	B45AB-R100150	\$329.82	1.26"	B45BC-R100150	\$331.80	0.60"	B45CC-R100150	\$336.44	1.70"
2"	2.516"	1.300"	B45AB-R200	347.01	1.26"	B45BC-R200	347.26	0.60"	B45CC-R200	350.22	1.70"
2½"	3.047"	1.300"	B45AB-R250	458.59	1.26"	B45BC-R250	447.69	0.60"	B45CC-R250	441.81	1.70"
3"	3.579"	1.300"	B45AB-R300	547.93	1.26"	B45BC-R300	528.13	0.60"	B45CC-R300	566.40	1.70"
4"	4.682"	1.300"	B45AB-R400	596.86	1.26"	B45BC-R400	635.72	0.60"	B45CC-R400	610.43	1.70"

Repair Kit for Air Blow Check Valves

Repair kit contains:

- (1) EPDM / 316L stainless perforated disc
- (1) 304 stainless spring retainer
- (1) 304 stainless spring
- (1) nylon stem guide
- (1) EPDM / 316L stainless steel plug and stem

Part #	Price/E
B45AB-RK	\$70.75

When using air blow check valves with ball check valves, refer to the sizing chart below.

Sizing Chart

Ball Check Valve Size	Air Blow Check Valve Size
1½"	2"
2"	2½"
2½"	3"
3"	4"

Our commitment to excellence and continuous research and development for improving product quality may warrant periodic changes in design and specification. We reserve the right to modify product design without prior notification and without incurring any liability to provide these modifications to products previously purchased.

Air & Vacuum Relief Tank Vent Valve

Features:

- valve relieves pressure as the fluid level rises while filling a tank
- valve relieves vacuum as the fluid level drops while emptying a tank
- 2" and 3" clamp connections on the same valve
- dome helps in preventing external contamination
- light weight, robust PVC and 304 stainless steel construction
- can use any clamp gasket
- maximum flow rate: 500 GPM
- vacuum break: .1 PSI
- pressure relief: .1 PSI



Valves

Size	304 Stainless Steel Part #	Price/E
2" - 3"	TVPC200-300	\$105.25

Dimensions

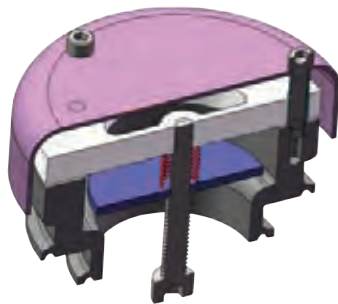
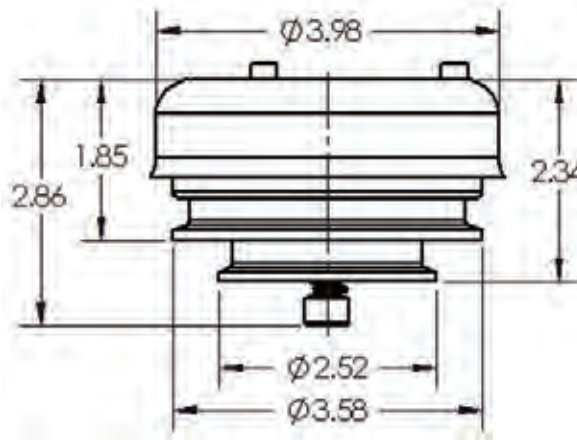

Assembly

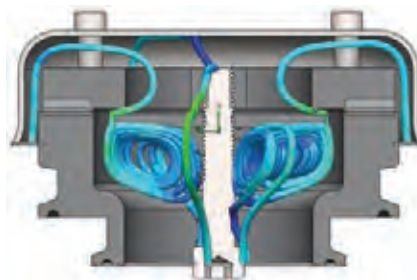

Vent Flow Pipes

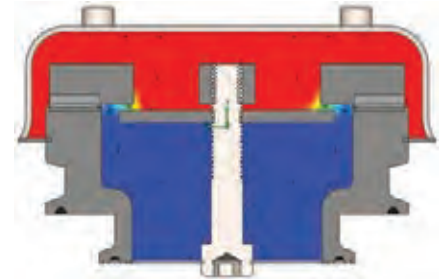

Pressure Analysis



Air & Vacuum Relief Tank Vent Valves

Applications:

- used to relieve pressure or vacuum when product filling or evacuation in a tank

Features:

- triple action
 - valve relieves pressure as the fluid level rises while filling a tank
 - valve relieves vacuum as the fluid level drops while emptying a tank
 - seals under equal pressure
- stainless steel screen surrounds the entire vacuum and pressure flow area
- sizes: 2", 3" or 4" – clamp connection standard
- other sanitary connections optional
- ¼" FNPT connection for gas inlet, plug also supplied
- vacuum break: 2" water column, 0.1 PSI
- pressure relief: 22" water column, 0.8 PSI
- maximum temperature and pressure rating: **3 PSI @ 70°F (21°C)**
- maximum flow rate: 500 GPM

Materials:

- 304 stainless steel, EPDM elastomer

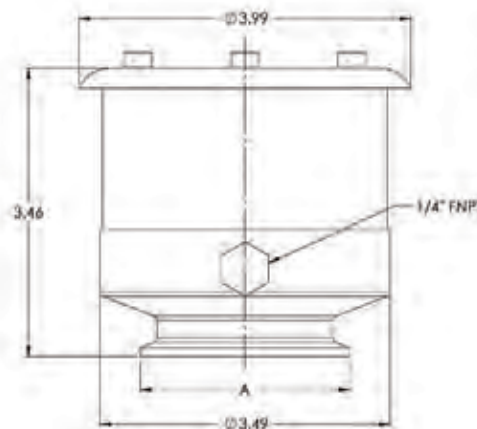
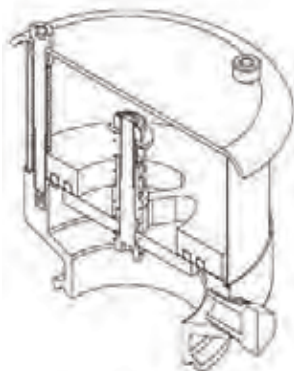

Tube OD	304 Stainless Steel	
	Part Number	Price/E
2"	TVSEC-G200	\$485.97
3"	TVSEC-G300	485.95
4"	TVSEC-G400	567.68



3A Sample Valves with Manual Handle

NEW3
1447**Applications:**

- The 3A sample valve allows easy and safe sampling of liquids from closed systems such as vessels and pipelines.
- These valves are located in the pharmaceutical, bio-pharmaceutical, biochemical, cosmetic, food, dairy and beverage markets.

Features:

- valve body made from solid bar
- no dead space
- drainable
- connections suitable for orbital welding
- available with single or dual ports
- hermetically sealed against environment
- optimum cleanability
- change of seals without special tools
- long life of the PTFE-bellows
- low spare part costs
- options for pneumatic actuator: no lever, with self-closing lever and with lever for open position
- manual actuator (hand wheel)

Materials:

- In product contact: 1.4404/AISI 316L
- Non product contact: 1.4301/AISI 304
- Product contact seals: PTFE bellows
- Surfaces: wetted product surfaces: Ra <= 32 (optional surface finishes available). Non product contact: Ra <= 63

Specifications:

- Closing tension operating pressure: maximum **116 PSI**
- Hand wheel version operating pressure: minimum **87 PSI**, maximum **232 PSI**
- Controlled air pressure: maximum **145 PSI**



single port



double port

Clamp Valve Size	Weld Port Size	Single Port Part Number	Price/E	Dual Port Part Number	Price/E
1/2"	1/4"	<i>BSVS-HC050B025</i>	\$1533.00	<i>BSVD-HC050B025</i>	\$1533.00
1/2"	3/8"	<i>BSVS-HC050B375</i>	1533.00	<i>BSVD-HC050B375</i>	1533.00
1/2"	1/2"	<i>BSVS-HC050B050</i>	1533.00	<i>BSVD-HC050B050</i>	1533.00
1"	1/4"	<i>BSVS-HC100B025</i>	1533.00	<i>BSVD-HC100B025</i>	1533.00
1"	3/8"	<i>BSVS-HC100B375</i>	1533.00	<i>BSVD-HC100B375</i>	1533.00
1"	1/2"	<i>BSVS-HC100B050</i>	1533.00	<i>BSVD-HC100B050</i>	1533.00
1 1/2"	1/4"	<i>BSVS-HC150B025</i>	POR	<i>BSVD-HC150B025</i>	POR
1 1/2"	3/8"	<i>BSVS-HC150B375</i>	POR	<i>BSVD-HC150B375</i>	POR
1 1/2"	1/2"	<i>BSVS-HC150B050</i>	POR	<i>BSVD-HC150B050</i>	POR
2"	1/4"	<i>BSVS-HC200B025</i>	1533.00	<i>BSVD-HC200B025</i>	1533.00
2"	3/8"	<i>BSVS-HC200B375</i>	1533.00	<i>BSVD-HC200B375</i>	1533.00
2"	1/2"	<i>BSVS-HC200B050</i>	1533.00	<i>BSVD-HC200B050</i>	1533.00
2 1/2"	1/4"	<i>BSVS-HC250B025</i>	1533.00	<i>BSVD-HC250B025</i>	1533.00
2 1/2"	3/8"	<i>BSVS-HC250B375</i>	1533.00	<i>BSVD-HC250B375</i>	1533.00
2 1/2"	1/2"	<i>BSVS-HC250B050</i>	1862.81	<i>BSVD-HC250B050</i>	1533.00
3"	1/4"	<i>BSVS-HC300B025</i>	1533.00	<i>BSVD-HC300B025</i>	1533.00
3"	3/8"	<i>BSVS-HC300B375</i>	1533.00	<i>BSVD-HC300B375</i>	1533.00
3"	1/2"	<i>BSVS-HC300B050</i>	1533.00	<i>BSVD-HC300B050</i>	1533.00
4"	1/4"	<i>BSVS-HC400B025</i>	1533.00	<i>BSVD-HC400B025</i>	1533.00
4"	3/8"	<i>BSVS-HC400B375</i>	1533.00	<i>BSVD-HC400B375</i>	1533.00
4"	1/2"	<i>BSVS-HC400B050</i>	1533.00	<i>BSVD-HC400B050</i>	1533.00

Electrically Actuated 2-Piece Stainless Ball Valves

Valves



Features:

2-Piece Stainless Ball Valve

- RTFE seats and seals
- blow-out proof stem
- live-loaded stem packing
- ISO 5211 mounting pad
- pressure rating: ¼" - 2" **1000 PSI WOG**, 2½" - 3" **800 PSI WOG**
- temperature range: **-40°F to 450°F (-40°C to 232°C)**

Electric Actuator

- lightweight powder coated aluminum alloy housing
- NEMA 4/4X waterproof and dustproof
- extended duty cycle induction motor
- high alloy steel gear train
- H-insulation class
- visual position indication
- space heater is standard
- manual override standard: ½" - 1½"
- temperature range: **-41°F to 140°F (-40°C to 60°)**
- ISO 9001, CS, CE and CSA-C US Certified
- RoHS compliant

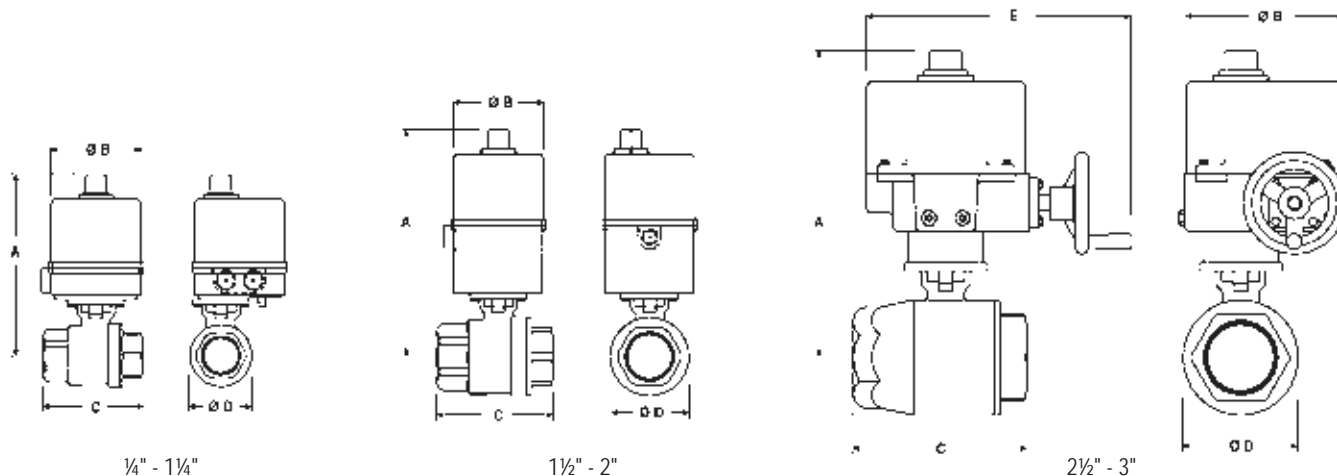

¼" - 1¼"

1½" - 2"

2½" - 3"

Dimensions are approximate.

Engineering dimensions are available upon request. Specifications are subject to change without notice.

Size	Dimensions					Override	316 Stainless Steel Part #	Voltage				
	A	B	C	D	E			110VAC -EA	24VDC -EG	12VDC -ET	220VAC -EK	24VAC -ES
¼"	7.79"	4.50"	2.56"	1.40"	NA	standard	BV2HG-02511	\$1138.94	\$1138.94	\$1138.94	\$1138.94	\$1138.94
⅜"	7.79"	4.50"	2.56"	1.40"	NA	standard	BV2HG-03811	1161.72	1161.72	1161.72	1161.72	1161.72
½"	7.74"	4.50"	2.95"	1.40"	NA	standard	BV2HG-05011	1292.67	1292.67	1292.67	1292.67	1292.67
¾"	7.84"	4.50"	3.15"	1.75"	NA	standard	BV2HG-07511	1321.74	1321.74	1321.74	1321.74	1321.74
1"	8.09"	4.50"	3.54"	1.75"	NA	standard	BV2HG-10011	1434.52	1434.52	1434.52	1434.52	1434.52
1¼"	8.29"	4.50"	4.33"	2.58"	NA	standard	BV2HG-12511	1429.74	1429.74	1429.74	1429.74	1429.74
1½"	8.69"	4.50"	4.72"	2.97"	NA	N/A	BV2HG-15011	1546.61	1573.61	1573.61	1573.61	1520.57
2"	11.13"	4.50"	5.51"	2.73"	NA	N/A	BV2HG-20011	2036.48	2036.48	2102.81	2036.48	2036.48
2½"	13.72"	7.08"	7.28"	4.68"	12.83"	handwheel	BV2HG-25011-EP¹	3463.54	---	---	---	---
2½"	10.69"	6.06"	7.28"	4.68"	NA	N/A	BV2HG-25011	3250.44	3250.44	3250.44	3250.44	3250.44
3"	13.72"	7.08"	8.07"	5.44"	12.83"	handwheel	BV2HG-30011	5097.93	5097.93	5097.93	5097.93	5097.93

¹ for 110VAC 2½" with manual override use -EP

A wide variety of options are available: modulating, extra switches, transmitters, potentiometer, etc. Contact Dixon® at 800.789.1718 or visit dixonvalve.com for details.

Caution !

Even though there are torque safety factors built into our automated ball valve packages, actual service conditions must also be considered when selecting the proper product for the appropriate application.

For example: Severe service conditions such as dirty water, dirty air, all slurries, raw sewage water, oils, and other viscous fluids can have a dramatic effect in raising the torque requirements of ball valves as much as 75% and therefore larger actuators may be required. Please consult Dixon® when dealing with these types of applications.



Electrically Actuated 3-Piece Stainless Ball Valves

Features:

3-Piece Stainless Ball Valve

- 15% glass reinforced RTFE seats
- blow-out proof stainless steel stem
- live-loaded stem packing
- ISO 5211 mounting pad
- swing out in-line easy maintenance
- pressure rating: ½" - 2" **1000 PSI WOG**, 3" **800 PSI WOG**
- temperature range: ½" to 2": **-40°F to 350°F (-40°C to 177°C)**, 3" to 4": **-40°F to 325°F (-40°C to 163°C)**

Electric Actuator

- lightweight powder coated aluminum alloy housing
- NEMA 4/4X waterproof and dustproof
- extended duty cycle induction motor
- high alloy steel gear train
- H-insulation class
- visual position indication
- space heater is standard
- manual override standard: ½" - 1½" sizes
- temperature range: **-41°F to 140°F (-41°C to 60°C)**
- ISO 9001, CS, CE and CSA-C US Certified
- RoHS compliant



Valves

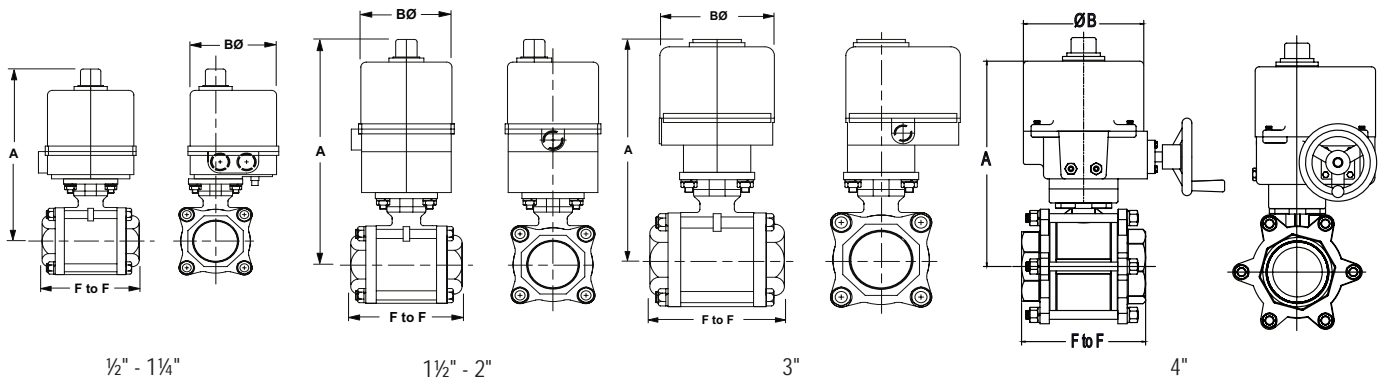

Dimensions are approximate.

Engineering dimensions are available upon request. Specifications are subject to change without notice.

Size	Dimensions			Override	316 Stainless Steel Part #	Voltage				
	F to F	A	B			110VAC -EA	24VDC -EG	12VDC -ET	220VAC -EK	24VAC -ES
½"	2.6"	7.8"	4.5"	standard	BV2IG-05011	\$1263.38	\$1190.33	\$1190.33	\$1190.33	\$1329.15
¾"	3.0"	8.0"	4.5"	standard	BV2IG-07511	1295.00	1407.31	1407.31	1407.31	1407.31
1"	3.4"	8.3"	4.5"	standard	BV2IG-10011	1392.77	1455.01	1455.01	1455.01	1455.01
1¼"	4.0"	8.5"	4.5"	standard	BV2IG-12511	1671.33	1671.33	1671.33	1671.33	1671.33
1½"	4.7"	9.2"	4.5"	N/A	BV2IG-15011	1432.43	1432.43	1432.43	1432.43	1432.43
2"	5.2"	11.4"	4.5"	N/A	BV2IG-20011	2080.17	2075.53	2075.53	2075.53	2075.53
3"	7.2"	12.2"	6.1"	N/A	BV2IG-30011	3763.72	4407.63	4552.67	3195.62	4552.67
4"	8.9"	16.1"	7.1"	N/A	BV2IG-40011	5827.25	6098.22	6024.88	6024.88	5784.12

A wide variety of options are available: modulating, extra switches, transmitters, potentiometer, etc. Contact Dixon® at 800.789.1718 or visit dixonvalve.com for details.

Caution !

Even though there are torque safety factors built into our automated ball valve packages, actual service conditions must also be considered when selecting the proper product for the appropriate application.

For example: Severe service conditions such as dirty water, dirty air, all slurries, raw sewage water, oils, and other viscous fluids can have a dramatic affect in raising the torque requirements of ball valves as much as 75% and therefore larger actuators may be required. Please consult Dixon® when dealing with these types of applications.



Electrically Actuated Brass Ball Valves

Valves



Features:

2-Piece Brass Ball Valve

- brass, body and ball
- FKM elastomers
- blow-out proof brass stem
- PTFE seats with double O-ring stem packing
- ISO 5211 mounting pad
- pressure rating: - **600 PSI WOG** , **150 PSI WSP**
- maximum temperature: **300°F (149°C)**

Electric Actuator

- lightweight powder coated aluminum alloy housing
- NEMA 4/4X waterproof and dustproof
- extended duty cycle induction motor
- high alloy steel gear train
- H-insulation class
- visual position indication
- space heater is standard
- manual override standard: ½" - 1½" sizes
- temperature range: **-41°F to 140°F (-41°C to 60°C)**
- ISO 9001, CS, CE and CSA-C US Certified
- RoHS compliant

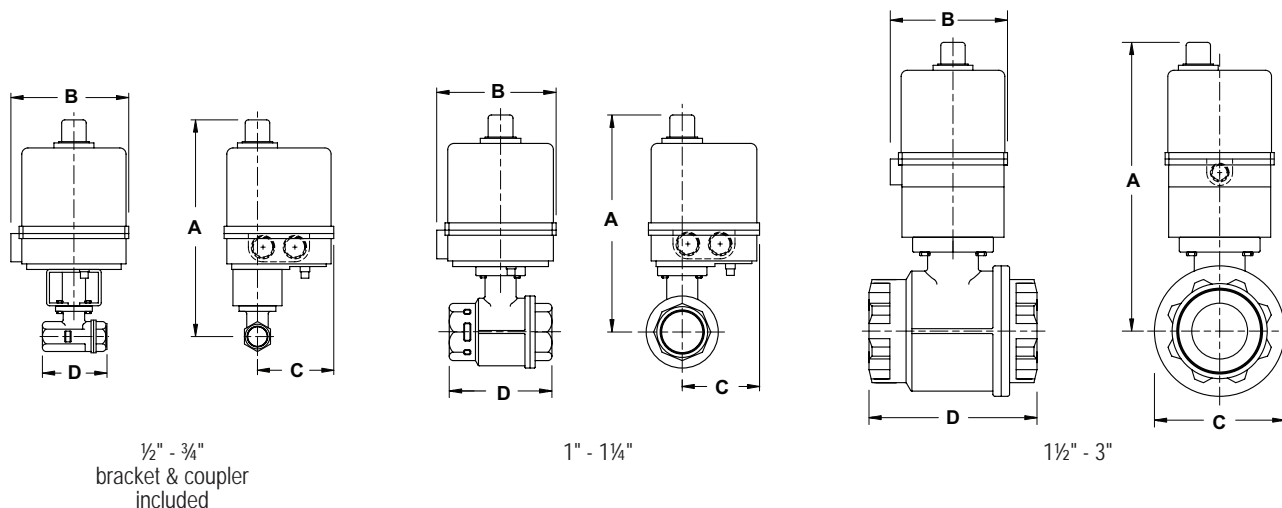

Dimensions are approximate.

Engineering dimensions are available upon request. Specifications are subject to change without notice.

Size	Dimensions				Override	Brass Part #	Voltage				
	A	B	C	D			110VAC -EA	24VDC -EG	12VDC -ET	220VAC -EK	24VAC -ES
½"	8.8"	4.5"	3.1"	2.6"	standard	BV2BV-05011	\$1261.44	\$1120.89	\$1098.92	\$1120.89	\$1259.77
¾"	9.2"	4.5"	3.1"	3.0"	standard	BV2BV-07511	1311.91	1285.88	1313.13	1313.13	1245.91
1"	9.4"	4.5"	3.1"	3.4"	standard	BV2BV-10011	1302.98	1400.46	1365.22	1506.07	1296.52
1¼"	9.5"	4.5"	3.1"	3.7"	standard	BV2BV-12511	1370.97	1481.06	1433.21	1413.32	1337.32
1½"	8.7"	4.5"	3.1"	4.1"	N/A	BV2BV-15011	1833.01	1828.37	1488.24	1906.31	1791.74
2"	9.0"	4.5"	3.1"	4.8"	N/A	BV2BV-20011	1887.71	1990.03	1993.70	2152.53	1938.68
3"	11.8"	6.1"	5.4"	6.9"	N/A	BV2BV-30011	3367.37	4191.22	2856.44	4555.66	3434.60

A wide variety of options are available: modulating, extra switches, transmitters, potentiometer, etc. Contact Dixon® at 800.789.1718 or visit dixonvalve.com for details.

Caution !

Even though there are torque safety factors built into our automated ball valve packages, actual service conditions must also be considered when selecting the proper product for the appropriate application.

For example: Severe service conditions such as dirty water, dirty air, all slurries, raw sewage water, oils, and other viscous fluids can have a dramatic affect in raising the torque requirements of ball valves as much as 75% and therefore larger actuators may be required. Please consult Dixon® when dealing with these types of applications.



Electrically Actuated 3-Way Stainless Ball Valves - 'T / L' Port

Features:

3-Way Stainless Ball Valve

- full port
- female NPT ends
- blow-out proof stem
- live-loaded stem packing
- ISO 5211 mounting pad
- 100% air tested under water at **80 PSI**
- working pressure: ¼" to 1": **1000 PSI**; 1¼" to 2": **800 PSI**
- maximum temperature: **300°F (149°C)**

Electric Actuator

- lightweight powder coated aluminum alloy housing
- NEMA 4/4X waterproof and dustproof
- extended duty cycle induction motor
- high alloy steel gear train
- H-insulation class
- visual position indication
- space heater is standard
- manual override standard: ½" - 1½" sizes
- temperature range: **-41°F to 140°F (-41°C to 60°C)**
- ISO 9001, CS, CE and CSA-C US Certified
- RoHS compliant

- A flow path needs to be selected at time of order. If no flow path is selected, the option number labeled as default will be shipped.
- Customer verification is critical. If flow path needs to be changed after being shipped, labor and shipping charges will apply.
- for spring return actuators must note fail position

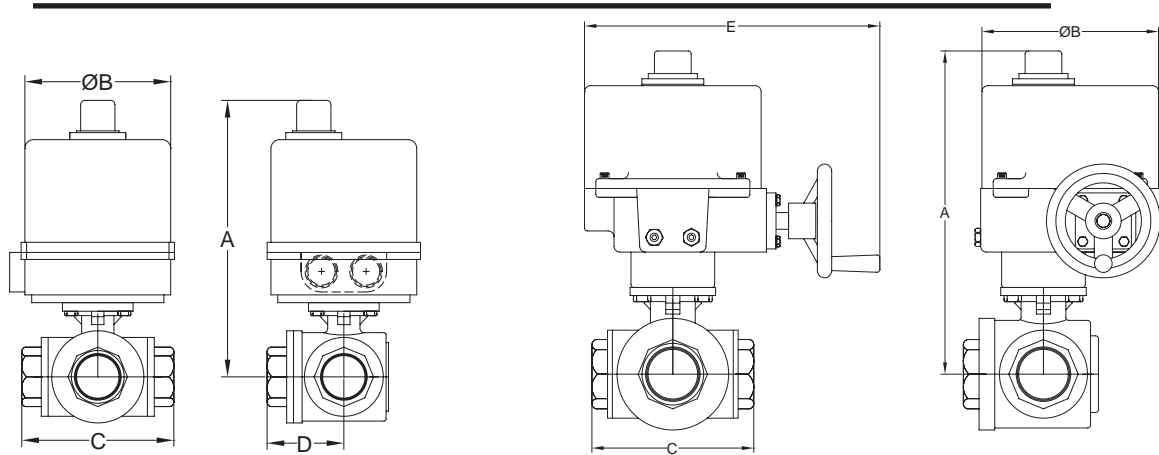

¼" - 1¼" 1½" - 2"
 Dimensions are approximate. Engineering dimensions are available upon request.
 Specifications are subject to change without notice.

* T = t style
 * L = l style

Size	Dimensions					Override	316 Stainless Steel Part #	Voltage				
	A	B	C	D	E			110VAC -EA	24VDC -EG	12VDC -ET	220VAC -EK	24VAC -ES
¼"	9.01"	6.06"	2.83"	1.41"	N/A	standard	BV3IG*F-0251	\$1533.02	\$1533.02	\$1533.02	\$1533.02	\$1671.75
⅜"	9.01"	6.06"	2.83"	1.41"	N/A	standard	BV3IG*F-0381	1533.02	1533.02	1533.02	1533.02	1671.75
½"	9.21"	6.06"	3.26"	1.63"	N/A	standard	BV3IG*F-0501	1533.02	1533.02	1533.02	1533.02	1671.75
¾"	9.21"	6.06"	3.89"	1.94"	N/A	standard	BV3IG*F-0751	1699.91	1699.91	1699.91	1699.91	1838.71
1"	9.74"	6.06"	4.40"	2.20"	N/A	standard	BV3IG*F-1001	1885.40	1885.40	1885.40	1885.40	2024.20
1¼"	10.04"	6.06"	4.92"	2.46"	N/A	standard	BV3IG*F-1251	2220.82	2220.82	2220.82	2220.82	2359.61
1½"	12.92"	7.87"	5.86"	2.93"	12.99"	handwheel	BV3IG*F-1501	3647.13	3647.13	3647.13	3647.13	3988.24
2"	13.67"	7.87"	6.85"	3.42"	12.99"	handwheel	BV3IG*F-2001	4489.63	4744.37	4744.37	4412.45	5686.26

A wide variety of options are available: modulating, extra switches, transmitters, potentiometer, etc. Contact Dixon® at 800.789.1718 or visit dixonvalve.com for details.

Caution !

Even though there are torque safety factors built into our automated ball valve packages, actual service conditions must also be considered when selecting the proper product for the appropriate application.

For example: Severe service conditions such as dirty water, dirty air, all slurries, raw sewage water, oils, and other viscous fluids can have a dramatic affect in raising the torque requirements of ball valves as much as 75% and therefore larger actuators may be required. Please consult Dixon® when dealing with these types of applications.



Electrically Actuated 3-Way Brass Ball Valves - 'T / L' Port

Valves



Features:

3-Way Brass Ball Valve

- reduced port
- blow-out proof stem
- brass body and chrome-plated brass ball
- PTFE seats with O-ring backing for low operating torque
- PTFE seats and double O-ring stem packing
- ISO 5211 mounting pad
- 100% tested
- pressure rating: **400 PSI WOG, 100 PSI WSP**
- maximum temperature: **300°F (149°C)**

Electric Actuator

- lightweight powder coated aluminum alloy housing
- NEMA 4/4X waterproof and dustproof
- extended duty cycle induction motor
- high alloy steel gear train
- H-insulation class
- visual position indication
- space heater is standard
- manual override standard: 1/2" - 1 1/2" sizes
- temperature range: **-41°F to 140°F (-41°C to 60°C)**
- ISO 9001, CS, CE and CSA-C US Certified
- RoHS compliant
- see page ??? for flow path options
- A flow path needs to be selected at time of order. If no flow path is selected, the option number labeled as default will be shipped.
- Customer verification is critical. If flow path needs to be changed after being shipped, labor and shipping charges will apply.
- for spring return actuators must note fail position

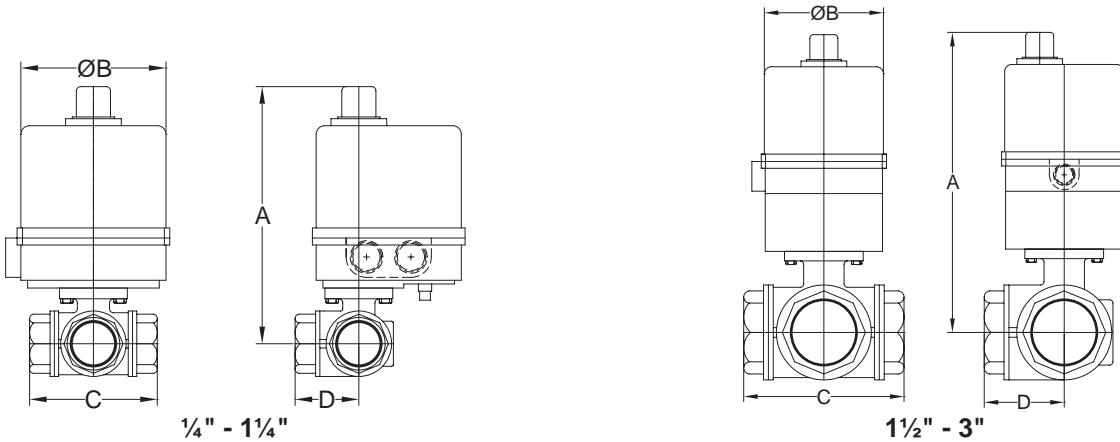

Dimensions are approximate. Engineering dimensions are available upon request.
Specifications are subject to change without notice.

* T = t-style
* L = l-style

Size	Dimensions				Override	Brass Part #	Voltage				
	A	B	C	D			110VAC -EA	24VDC -EG	12VDC -ET	220VAC -EK	24VAC -ES
1/4"	8.76"	6.06"	2.64"	1.32"	standard	BV3BV*R-0251	\$1237.15	\$1237.15	\$1237.15	\$1237.15	\$1237.15
3/8"	8.76"	6.06"	2.64"	1.32"	standard	BV3BV*R-0381	1237.15	1237.15	1237.15	1237.15	1237.15
1/2"	8.76"	6.06"	2.87"	1.44"	standard	BV3BV*R-0501	1237.15	1237.15	1237.15	1237.15	1237.15
3/4"	8.85"	6.06"	3.19"	1.60"	standard	BV3BV*R-0751	1267.63	1267.63	1267.63	1267.63	1267.63
1"	9.19"	6.06"	3.74"	1.87"	standard	BV3BV*R-1001	1311.10	1311.10	1311.10	1311.10	1311.10
1 1/4"	9.41"	6.06"	4.39"	2.20"	standard	BV3BV*R-1251	1446.43	1446.43	1446.43	1446.43	1446.43
1 1/2"	9.90"	6.06"	4.86"	2.43"	N/A	BV3BV*R-1501	1787.98	1787.98	1787.98	1787.98	1787.98
2"	10.89"	4.25"	5.73"	2.87"	N/A	BV3BV*R-2001	2574.95	2574.95	2574.95	2574.95	2574.95
2 1/2"	11.34"	4.25"	6.93"	3.47"	N/A	BV3BV*R-2501	3769.14	3769.14	3769.14	3769.14	3769.14
3"	11.34"	4.25"	7.08"	3.54"	N/A	BV3BV*R-3001	3599.43	3599.43	3599.43	3599.43	3599.43

A wide variety of options are available: modulating, extra switches, transmitters, potentiometer, etc. Contact Dixon® at 800.789.1718 or visit dixonvalve.com for details.

Caution !

Even though there are torque safety factors built into our automated ball valve packages, actual service conditions must also be considered when selecting the proper product for the appropriate application.

For example: Severe service conditions such as dirty water, dirty air, all slurries, raw sewage water, oils, and other viscous fluids can have a dramatic affect in raising the torque requirements of ball valves as much as 75% and therefore larger actuators may be required. Please consult Dixon® when dealing with these types of applications.



Pneumatically Actuated 2-Piece Stainless Ball Valves

Features:

2-Piece Stainless Ball Valve

- RTFE seats and seals
- blow-out proof stem
- live-loaded stem packing
- ISO 5211 mounting pad
- pressure rating: ¼" - 2" **1000 PSI WOG**, 2½" - 3" **800 PSI WOG**
- temperature range: ¼" to 2": **-40°F to 350°F (-40°C to 177°C)**, 2½" to 3": **-40°F to 325°F (-40°C to 163°C)**

Rack and Pinion Actuator

- hard anodized aluminum body
- nickel plated anti-blowout pinion
- Buna-N O-rings
- NAMUR mounting
- bi-directional stops for ±5° travel adjustment
- **80 PSI** plant air required
- visual position indication
- maximum operating pressure: **120 PSI**
- temperature range: **-40°F to 200°F (-40°C to 93°C)**
- tested to one million cycles



Valves

Spring Return (normally closed)

Dimensions are approximate. Engineering dimensions are available upon request. Specifications are subject to change without notice.

Size	Dimensions				316 Stainless Steel	
	A	B	C	D	Part #	Price/E
¼"	5.21"	2.80"	2.56"	5.49"	BV2HG-02511-BBC	\$673.00
⅜"	5.21"	2.80"	2.56"	5.49"	BV2HG-03811-BBC	679.59
½"	5.16"	2.80"	2.95"	5.49"	BV2HG-05011-BBC	712.63
¾"	5.26"	2.80"	3.15"	5.49"	BV2HG-07511-BBC	718.86
1"	6.64"	3.74"	3.54"	8.09"	BV2HG-10011-BBC	779.63
1¼"	6.84"	3.74"	4.33"	8.09"	BV2HG-12511-BBC	837.54
1½"	8.14"	4.69"	4.72"	9.84"	BV2HG-15011-BBC	1079.87
2"	8.69"	4.69"	5.51"	9.84"	BV2HG-20011-BBC	1440.75
2½"	9.54"	5.53"	7.28"	13.98"	BV2HG-25011-BBC	1967.77
3"	11.39"	7.29"	8.07"	16.61"	BV2HG-30011-BBC	4379.38

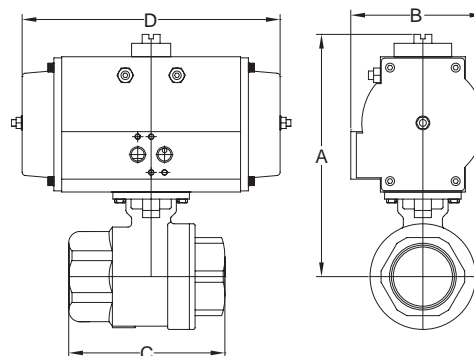

Double Acting

Dimensions are approximate. Engineering dimensions are available upon request. Specifications are subject to change without notice.

Size	Dimensions				316 Stainless Steel	
	A	B	C	D	Part #	Price/E
¼"	4.25"	1.77"	2.56"	4.33"	BV2HG-02511-BCC	\$482.22
⅜"	4.25"	1.77"	2.56"	4.33"	BV2HG-03811-BCC	447.14
½"	4.20"	1.77"	2.95"	4.33"	BV2HG-05011-BCC	467.71
¾"	4.30"	1.77"	3.15"	4.33"	BV2HG-07511-BCC	516.51
1"	5.89"	3.20"	3.54"	5.68"	BV2HG-10011-BCC	652.37
1¼"	6.09"	3.20"	4.33"	5.68"	BV2HG-12511-BCC	710.19
1½"	7.24"	3.74"	4.72"	5.87"	BV2HG-15011-BCC	874.77
2"	7.79"	3.74"	5.51"	5.87"	BV2HG-20011-BCC	1437.78
2½"	8.75"	4.69"	7.28"	7.20"	BV2HG-25011-BCC	1796.57
3"	10.01"	5.53"	8.07"	10.22"	BV2HG-30011-BCC	3754.86

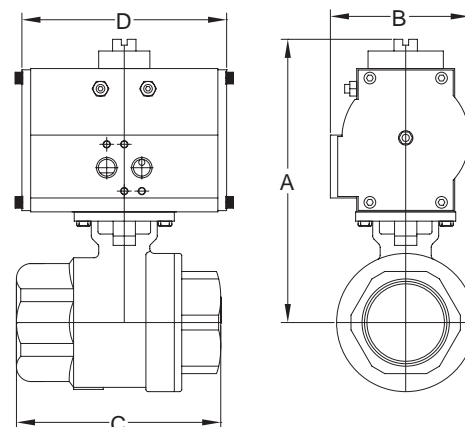

A wide variety of switches, solenoids, positioners, etc., are available. Contact Dixon® at 800.789.1718 or visit dixonvalve.com for details.

Caution !

Even though there are torque safety factors built into our automated ball valve packages, actual service conditions must also be considered when selecting the proper product for the appropriate application.

For example: Severe service conditions such as dirty water, dirty air, all slurries, raw sewage water, oils, and other viscous fluids can have a dramatic affect in raising the torque requirements of ball valves as much as 75% and therefore larger actuators may be required. Please consult Dixon® when dealing with these types of applications.



Pneumatically Actuated 3-Piece Stainless Ball Valves

Valves



Features:

3-Piece Stainless Ball Valve

- 15% glass reinforced RTFE seats
- blow-out proof stainless steel stem
- live-loaded stem packing
- ISO 5211 mounting pad
- swing out in-line easy maintenance
- pressure rating: ½" - 2" **1000 PSI WOG**, 3" **800 PSI WOG**
- temperature range: ½" to 2" **-40°F to 350°F (-40°C to 177°C)**, 3" to 4": **-40°F to 325°F (-40°C to 163°C)**

Rack and Pinion Actuator

- hard anodized aluminum body
- nickel plated anti-blowout pinion
- Buna-N O-rings
- NAMUR mounting
- bi-directional stops for ±5° travel adjustment
- 80 PSI plant air required
- visual position indication
- maximum operating pressure: **120 PSI**
- temperature range: **-40°F to 200°F (-40°C to 93°C)**
- tested to one million cycles

Spring Return (normally closed)

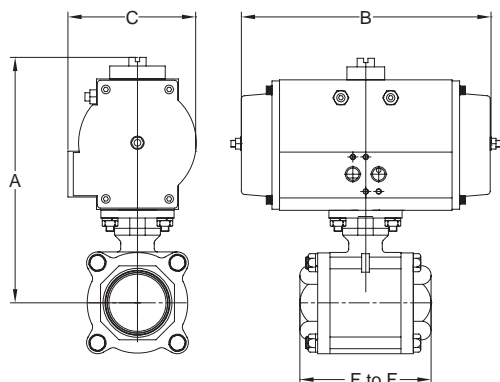

Dimensions are approximate. Engineering dimensions are available upon request. Specifications are subject to change without notice.

Size	Dimensions				316 Stainless Steel	
	F to F	A	B	C	Part #	Price/E
½"	2.6"	7.0"	7.7"	3.2"	BV2IG-05011-BBC ¹	\$760.33
¾"	3.0"	7.2"	7.7"	3.2"	BV2IG-07511-BBC ¹	767.28
1"	3.4"	6.1"	7.7"	3.2"	BV2IG-10011-BBC	813.72
1¼"	4.0"	6.3"	7.7"	3.2"	BV2IG-12511-BBC	888.58
1½"	4.7"	7.7"	8.1"	3.7"	BV2IG-15011-BBC	1031.95
2"	5.2"	8.8"	8.1"	3.7"	BV2IG-20011-BBC	1497.59
3"	7.2"	10.2"	9.8"	4.7"	BV2IG-30011-BBC	2938.28
4"	8.9"	12.4"	10.9"	5.5"	BV2IG-40011-BBC	5514.16

¹ bracket and coupler required for ½" and ¾" spring return actuator

Double Acting

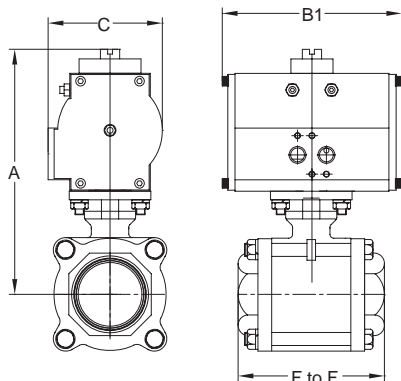

Dimensions are approximate. Engineering dimensions are available upon request. Specifications are subject to change without notice.

Size	Dimensions				316 Stainless Steel	
	F to F	A	B1	C	Part #	Price/E
½"	2.6"	5.0"	4.7"	2.4"	BV2IG-05011-BCC	\$483.99
¾"	3.0"	5.2"	4.7"	2.4"	BV2IG-07511-BCC	519.18
1"	3.4"	6.1"	5.7"	3.2"	BV2IG-10011-BCC	672.28
1¼"	4.0"	6.3"	5.7"	3.2"	BV2IG-12511-BCC	760.56
1½"	4.7"	7.7"	5.9"	3.7"	BV2IG-15011-BCC	1031.95
2"	5.2"	8.0"	5.9"	3.7"	BV2IG-20011-BCC	1118.24
3"	7.2"	10.2"	7.2"	4.7"	BV2IG-30011-BCC	2380.69
4"	8.9"	13.8"	16.3"	7.2"	BV2IG-40011-BCC	3974.27

A wide variety of switches, solenoids, positioners, etc., are available. Contact Dixon® at 800.789.1718 or visit dixonvalve.com for details.

Caution !

Even though there are torque safety factors built into our automated ball valve packages, actual service conditions must also be considered when selecting the proper product for the appropriate application.

For example: Severe service conditions such as dirty water, dirty air, all slurries, raw sewage water, oils, and other viscous fluids can have a dramatic affect in raising the torque requirements of ball valves as much as 75% and therefore larger actuators may be required. Please consult Dixon® when dealing with these types of applications.



Pneumatically Actuated Brass Ball Valves

Features:

2-Piece Brass Ball Valve

- brass, body and ball
- FKM elastomers
- blow-out proof brass stem
- PTFE seats with double O-ring stem packing
- ISO 5211 mounting pad
- pressure rating: - **600 PSI WOG, 150 PSI WSP**
- maximum temperature: **300°F (149°C)**

Rack and Pinion Actuator

- hard anodized aluminum body
- nickel plated anti-blowout pinion
- Buna-N O-rings
- NAMUR mounting
- bi-directional stops for $\pm 5^\circ$ travel adjustment
- 80 PSI plant air required
- visual position indication
- maximum operating pressure: **120 PSI**
- temperature range: **-40°F to 200°F (-40°C to 93°C)**
- tested to one million cycles



Valves

Spring Return (normally closed)

All dimensions are given in inches, unless noted. Dimensions are approximate. Engineering dimensions are available upon request. Specifications are subject to change without notice.

Size	Dimensions				Brass	
	A	B	C	D	Part #	Price/E
1/4"	4.80"	2.80"	2.64"	5.49"	BV2BV-02511-BBC	\$678.62
3/8"	4.80"	2.80"	2.64"	5.49"	BV2BV-03811-BBC	661.24
1/2"	4.80"	2.80"	2.64"	5.49"	BV2BV-05011-BBC	690.89
3/4"	4.88"	2.80"	3.00"	5.49"	BV2BV-07511-BBC	671.00
1"	5.31"	2.80"	3.35"	5.49"	BV2BV-10011-BBC	703.02
1 1/4"	5.45"	2.80"	3.66"	5.49"	BV2BV-12511-BBC	900.19
1 1/2"	6.04"	2.80"	4.13"	5.49"	BV2BV-15011-BBC	1011.98
2"	6.40"	2.80"	4.80"	5.49"	BV2BV-20011-BBC	1283.44
2 1/2"	8.13"	3.74"	6.10"	8.09"	BV2BV-25011-BBC	1673.97
3"	8.50"	3.74"	6.89"	8.09"	BV2BV-30011-BBC	2401.83
4"	10.14"	4.69"	8.03"	9.84"	BV2BV-40011-BBC	2913.27

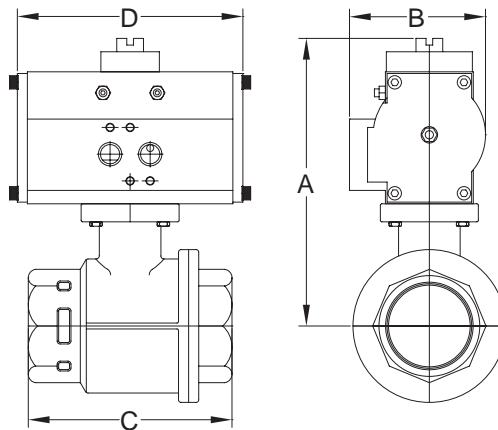

Double Acting

Dimensions are approximate. Engineering dimensions are available upon request. Specifications are subject to change without notice.

Size	Dimensions				Brass	
	A	B	C	D	Part #	Price/E
1/4"	3.84"	1.77"	2.64"	4.33"	BV2BV-02511-BCC	\$486.58
3/8"	3.84"	1.77"	2.64"	4.33"	BV2BV-03811-BCC	469.11
1/2"	3.84"	1.77"	2.64"	4.33"	BV2BV-05011-BCC	414.55
3/4"	3.92"	1.77"	3.00"	4.33"	BV2BV-07511-BCC	542.92
1"	4.35"	1.77"	3.35"	4.33"	BV2BV-10011-BCC	575.00
1 1/4"	4.49"	1.77"	3.66"	4.33"	BV2BV-12511-BCC	741.19
1 1/2"	6.42"	3.20"	4.13"	5.68"	BV2BV-15011-BCC	801.02
2"	6.78"	3.20"	4.80"	5.68"	BV2BV-20011-BCC	904.04
2 1/2"	8.13"	3.74"	6.10"	5.87"	BV2BV-25011-BCC	1488.97
3"	8.50"	3.74"	6.89"	5.87"	BV2BV-30011-BCC	1844.12
4"	10.14"	4.69"	8.03"	7.20"	BV2BV-40011-BCC	2355.68

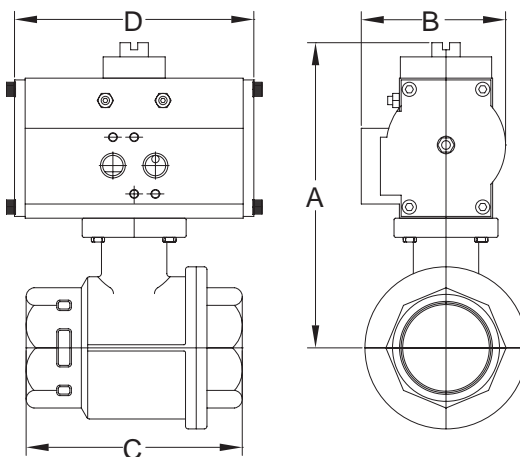

A wide variety of switches, solenoids, positioners, etc., are available. Contact Dixon® at 800.789.1718 or visit dixonvalve.com for details.

Caution !

Even though there are torque safety factors built into our automated ball valve packages, actual service conditions must also be considered when selecting the proper product for the appropriate application.

For example: Severe service conditions such as dirty water, dirty air, all slurries, raw sewage water, oils, and other viscous fluids can have a dramatic affect in raising the torque requirements of ball valves as much as 75% and therefore larger actuators may be required. Please consult Dixon® when dealing with these types of applications.



Pneumatically Actuated 3-Way Stainless Ball Valves - 'T / L' Port

Valves



Features:

3-Way Stainless Ball Valve

- full port
- female NPT ends
- blow-out proof stem
- live-loaded stem packing
- ISO 5211 mounting pad
- 100% air tested under water at **80 PSI**
- working pressure: ¼" to 1": **1000 PSI**; 1¼" to 2": **800 PSI**
- maximum temperature: **300°F (149°C)**

Rack and Pinion Actuator

- hard anodized aluminum body
- nickel plated anti-blowout pinion
- Buna-N O-rings
- NAMUR mounting
- bi-directional stops for ±5° travel adjustment
- 80 PSI plant air required
- visual position indication
- maximum operating pressure: **120 PSI**
- temperature range: **-40°F to 200°F (-40° to 93°C)**
- tested to one million cycles

- A flow path needs to be selected at time of order. If no flow path is selected, the option number labeled as default will be shipped.
- Customer verification is critical. If flow path needs to be changed after being shipped, labor and shipping charges will apply.
- for spring return actuators must note fail position

Spring Return (normally closed)

Dimensions are approximate. Engineering dimensions are available upon request. Specifications are subject to change without notice.

* T = t-style
* L = l-style

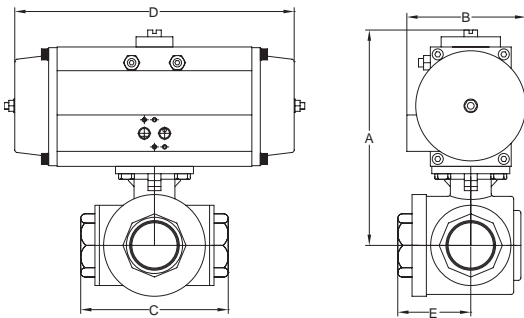

Size	Dimensions					316 Stainless Steel	
	A	B	C	D	E	Part #	Price/E
¼"	5.35"	3.20"	2.83"	7.10"	1.41"	BV3IG*F-0251BBC	\$1103.01
¾"	5.35"	3.20"	2.83"	7.10"	1.41"	BV3IG*F-0381BBC	1103.01
½"	5.55"	3.20"	3.26"	7.10"	1.63"	BV3IG*F-0501BBC	1103.01
¾"	6.30"	3.74"	3.89"	7.45"	1.94"	BV3IG*F-0751BBC	1345.69
1"	6.83"	3.74"	4.40"	7.45"	2.20"	BV3IG*F-1001BBC	1531.10
1¼"	7.13"	3.74"	4.92"	7.45"	2.46"	BV3IG*F-1251BBC	2086.97
1½"	8.43"	4.69"	5.86"	9.10"	2.93"	BV3IG*F-1501BBC	2437.31
2"	9.97"	5.53"	6.85"	12.99"	3.42"	BV3IG*F-2001BBC	3898.83

Double Acting

Dimensions are approximate. Engineering dimensions are available upon request. Specifications are subject to change without notice.

* T = t-style
* L = l-style

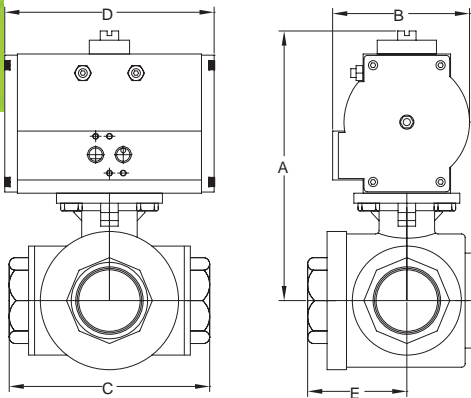

Size	Dimensions					316 Stainless Steel	
	A	B	C	D	E	Part #	Price/E
¾"	5.35"	3.20"	2.83"	7.10"	1.41"	BV3IG*F-0381BCC	\$975.00
½"	5.55"	3.20"	3.26"	7.10"	1.63"	BV3IG*F-0501BCC	975.00
¾"	6.30"	3.74"	3.89"	7.45"	1.94"	BV3IG*F-0751BCC	1106.94
1"	6.83"	3.74"	4.40"	7.45"	2.20"	BV3IG*F-1001BCC	1372.18
1¼"	7.13"	3.74"	4.92"	7.45"	2.46"	BV3IG*F-1251BCC	1914.73
1½"	8.43"	4.69"	5.86"	9.10"	2.93"	BV3IG*F-1501BCC	2311.71
2"	9.97"	5.53"	6.85"	12.99"	3.42"	BV3IG*F-2001BCC	3341.13

A wide variety of switches, solenoids, positioners, etc., are available. Contact Dixon® at 800.789.1718 or visit dixonvalve.com for details.

Caution !

Even though there are torque safety factors built into our automated ball valve packages, actual service conditions must also be considered when selecting the proper product for the appropriate application.

For example: Severe service conditions such as dirty water, dirty air, all slurries, raw sewage water, oils, and other viscous fluids can have a dramatic affect in raising the torque requirements of ball valves as much as 75% and therefore larger actuators may be required. Please consult Dixon® when dealing with these types of applications.



Pneumatically Actuated 3-Way Brass Ball Valves - 'T / L' Port

Features:

3-Way Brass Ball Valve

- reduced port
- blow-out proof stem
- brass body and chrome-plated brass ball
- PTFE seats with O-ring backing for low operating torque
- PTFE seats and double O-ring stem packing
- ISO 5211 mounting pad
- 100% tested
- pressure rating: **400 PSI WOG 100 PSI WSP**
- maximum temperature: **300°F (149°C)**

Rack and Pinion Actuator

- hard anodized aluminum body
- nickel plated anti-blowout pinion
- Buna-N O-rings
- NAMUR mounting
- bi-directional stops for $\pm 5^\circ$ travel adjustment
- 80 PSI plant air required
- visual position indication
- maximum operating pressure: **120 PSI**
- temperature range: **-40°F to 200°F (-40°C to 93°C)**
- tested to one million cycles

- A flow path needs to be selected at time of order. If no flow path is selected, the option number labeled as default will be shipped.
- Customer verification is critical. If flow path needs to be changed after being shipped, labor and shipping charges will apply.
- for spring return actuators must note fail position



Valves

Spring Return (normally closed)

All dimensions are given in inches, unless noted. Dimensions are approximate. Engineering dimensions are available upon request. Specifications are subject to change without notice.

* T = t-style
* L = l-style

Size	Dimensions					Brass	
	A	B	C	D	E	Part #	Price/E
1/4"	4.72"	2.80"	2.64"	5.49"	1.32"	BV3BV*R-0251BBC	\$810.90
3/8"	4.72"	2.80"	2.64"	5.49"	1.32"	BV3BV*R-0381BBC	810.90
1/2"	4.72"	2.80"	2.87"	5.49"	1.44"	BV3BV*R-0501BBC	810.90
3/4"	4.81"	2.80"	3.19"	5.49"	1.60"	BV3BV*R-0751BBC	858.61
1"	6.28"	3.74"	3.74"	7.45"	1.87"	BV3BV*R-1001BBC	1002.50
1 1/4"	6.50"	3.74"	4.39"	7.45"	2.20"	BV3BV*R-1251BBC	1078.21
1 1/2"	6.99"	3.74"	4.86"	7.45"	2.43"	BV3BV*R-1501BBC	1539.81
2"	8.45"	4.69"	5.73"	9.10"	2.87"	BV3BV*R-2001BBC	2160.75
2 1/2"	8.90"	4.69"	6.93"	9.10"	3.47"	BV3BV*R-2501BBC	3332.62
3"	8.90"	4.69"	7.08"	9.10"	3.54"	BV3BV*R-3001BBC	3251.56

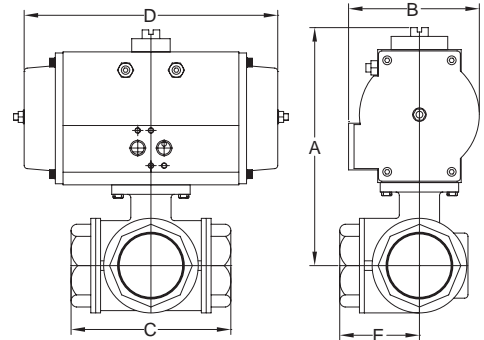

Double Acting

Dimensions are approximate. Engineering dimensions are available upon request. Specifications are subject to change without notice.

* T = t-style
* L = l-style

Size	Dimensions					Brass	
	A	B	C	D	E	Part #	Price/E
1/4"	3.76"	1.77"	2.64"	4.33"	1.32"	BV3BV*R-0251BCC	\$620.43
3/8"	3.76"	1.77"	2.64"	4.33"	1.32"	BV3BV*R-0381BCC	620.43
1/2"	3.76"	1.77"	2.87"	4.33"	1.44"	BV3BV*R-0501BCC	633.06
3/4"	3.85"	1.77"	3.19"	4.33"	1.60"	BV3BV*R-0751BCC	649.11
1"	5.53"	3.20"	3.74"	5.32"	1.87"	BV3BV*R-1001BCC	824.75
1 1/4"	5.75"	3.20"	4.39"	5.32"	2.20"	BV3BV*R-1251BCC	995.40
1 1/2"	6.24"	3.20"	4.86"	5.32"	2.43"	BV3BV*R-1501BCC	1315.61
2"	7.55"	3.74"	5.73"	5.51"	2.87"	BV3BV*R-2001BCC	1856.75
2 1/2"	8.00"	3.74"	6.93"	5.51"	3.47"	BV3BV*R-2501BCC	2972.35
3"	8.00"	3.74"	7.08"	5.51"	3.54"	BV3BV*R-3001BCC	2902.53

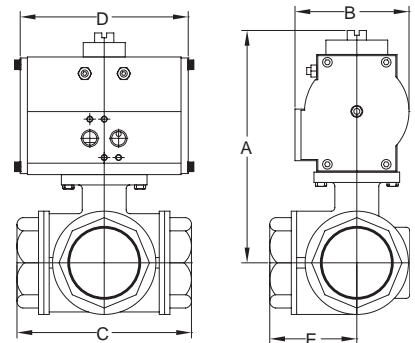

A wide variety of switches, solenoids, positioners, etc., are available. Contact Dixon® at 800.789.1718 or visit dixonvalve.com for details.

Caution !

Even though there are torque safety factors built into our automated ball valve packages, actual service conditions must also be considered when selecting the proper product for the appropriate application.

For example: Severe service conditions such as dirty water, dirty air, all slurries, raw sewage water, oils, and other viscous fluids can have a dramatic affect in raising the torque requirements of ball valves as much as 75% and therefore larger actuators may be required. Please consult Dixon® when dealing with these types of applications.



Pneumatically Actuated Wafer Butterfly Valves

Valves

Features:

- installs between standard ANSI Class 150# flanges
- ductile iron body with extended neck
- nickel plated ductile iron disc
- seat backing ring ensures blowout proof service
- conforms to MSS-SP-67, MSS-SP-25, API-609
- no taper pins
- field repairable (seat kits available)
- replaceable EPDM seat
- maximum operating pressure: **200 PSI** (bi-directional)
- temperature range: **-20°F to 250°F (-29°C to 121°C)**
- a wide variety of seat, disc and body materials are available

Rack and Pinion Actuators

Features:

- bi-directional stops for $\pm 5^\circ$ travel adjustment
- **80 PSI** plant air required
- maximum operating pressure: **120 PSI**
- temperature range: **-40°F to 200°F (-40°C to 93°C)**
- hard anodized aluminum body
- Namur mounting
- nickel plated anti-blowout pinion
- Buna-N O-rings
- visual position indication
- tested to 1 million cycles

Valves

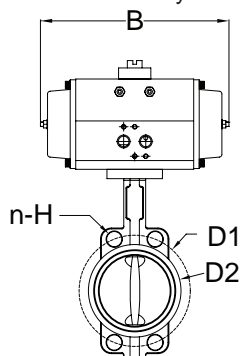

Spring Return

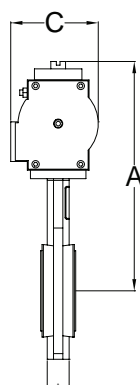

Double Acting

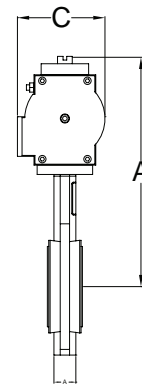
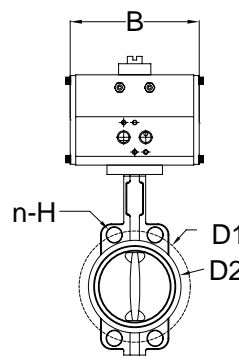

All dimensions are given in inches, unless noted. Dimensions are approximate. Engineering dimensions are available upon request. Specifications are subject to change without notice.

Wafer Spring Return

Size	A	B	C	D1	D2	n-H	Part #	Price/E
1½"	9.61"	8.09"	3.74"	3.88"	3.74"	4-18	B5121E150W-BBC	\$731.90
2"	9.80"	8.09"	3.74"	4.75"	3.82"	4-18	B5121E200W-BBC	734.50
2½"	11.65"	9.84"	4.69"	5.50"	4.45"	4-18	B5121E250W-BBC	958.40
3"	11.89"	9.84"	4.69"	6.00"	4.92"	4-18	B5121E300W-BBC	980.10
4"	12.63"	9.84"	4.69"	7.50"	6.14"	4-22	B5121E400W-BBC	1041.30
5"	13.94"	13.98"	5.53"	8.50"	7.36"	4-22	B5121E500W-BBC	1427.50
6"	14.45"	13.98"	5.53"	9.50"	8.46"	4-22	B5121E600W-BBC	1487.00
8"	17.17"	16.60"	7.29"	11.75"	10.51"	4-22	B5121E800W-BBC	2796.80
10"	19.21"	19.17"	8.06"	14.25"	13.00"	4-26	B5121E1000W-BBC	3579.00
12"	22.87"	25.28"	9.37"	17.00"	14.96"	4-26	B5121E1200W-BBC	8865.10

Wafer Double Acting

Size	A	B	C	D1	D2	n-H	Part #	Price/E
1½"	9.61"	5.87"	3.74"	3.88"	3.74"	4-18	B5121E150W-BCC	\$599.30
2"	9.80"	5.87"	3.74"	4.75"	3.82"	4-18	B5121E200W-BCC	601.80
2½"	10.75"	5.87"	3.74"	5.50"	4.45"	4-18	B5121E250W-BCC	620.80
3"	10.99"	5.87"	3.74"	6.00"	4.92"	4-18	B5121E300W-BCC	642.50
4"	11.73"	5.87"	3.74"	7.50"	6.14"	4-22	B5121E400W-BCC	732.70
5"	13.15"	7.20"	4.69"	8.50"	7.36"	4-22	B5121E500W-BCC	973.00
6"	13.66"	7.20"	4.69"	9.50"	8.46"	4-22	B5121E600W-BCC	1032.40
8"	15.79"	10.22"	5.53"	11.75"	10.51"	4-22	B5121E800W-BCC	1558.00
10"	17.05"	10.22"	5.53"	14.25"	13.00"	4-26	B5121E1000W-BCC	1609.90
12"	20.20"	11.98"	7.29"	17.00"	14.96"	4-26	B5121E1200W-BCC	2736.80

Pneumatically Actuated Lug Butterfly Valves

Valves

Features:

- ductile iron body with extended neck
- nickel plated ductile iron disc
- seat backing ring ensures blowout proof service
- installs between standard ANSI Class 150# flanges
- conforms to MSS-SP-67, MSS-SP-25, API-609
- no taper pins
- field repairable (seat kits available)
- replaceable EPDM seat
- maximum operating pressure: **200 PSI** (bi-directional)
- temperature range: **-20°F to 250°F (-29°C to 121°C)**
- a wide variety of seat, disc and body materials are available

Rack and Pinion Actuator

Features:

- bi-directional stops for $\pm 5^\circ$ travel adjustment
- **80 PSI** plant air required
- maximum operating pressure: **120 PSI**
- temperature range: **-40°F to 200°F (-40°C to 93°C)**
- hard anodized aluminum body
- Namur mounting
- nickel plated anti-blowout pinion
- Buna-N O-rings
- visual position indication
- tested to 1 million cycles
- a wide variety of switches, solenoids, positioners, etc., are available, contact Dixon® for details

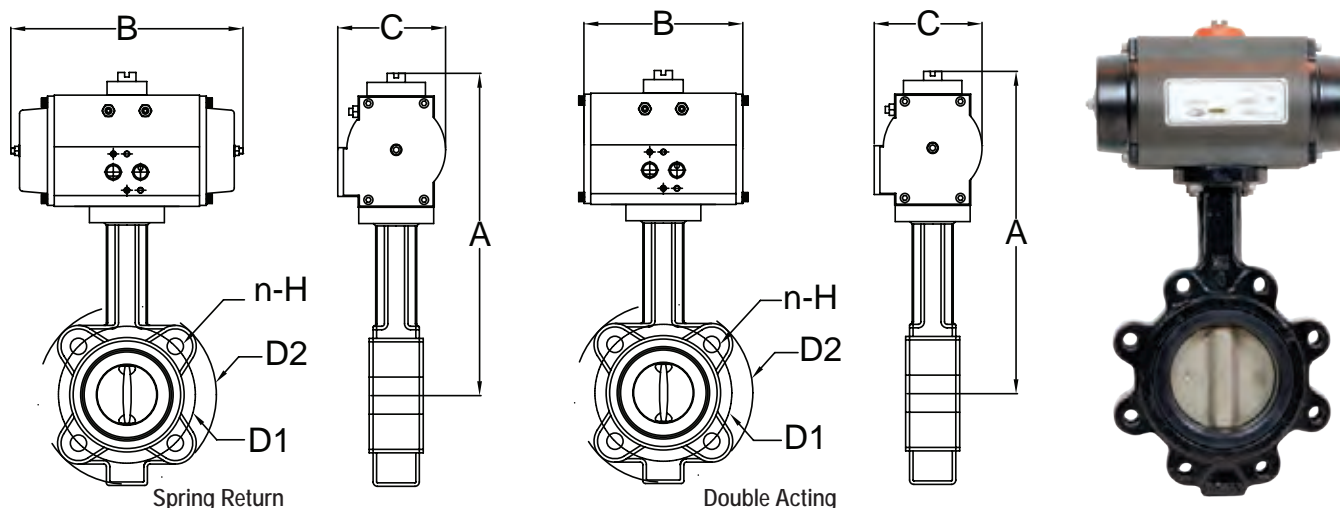

All dimensions are given in inches, unless noted. Dimensions are approximate. Engineering dimensions are available upon request. Specifications are subject to change without notice.

Lug Spring Return

Size	A	B	C	D1	D2	n-H	Part #	Price/E
2"	9.80	8.09	3.74	.75	5.95	4-5/8-11 UNC	B5121E200L-BBC	\$755.80
2½"	11.65	9.84	4.69	5.50	6.97	4-5/8-11 UNC	B5121E250L-BBC	1002.20
3"	11.89	9.84	4.69	6.00	7.56	4-5/8-11 UNC	B5121E300L-BBC	1032.10
4"	12.63	9.84	4.69	7.50	8.35	8-5/8-11 UNC	B5121E400L-BBC	1123.40
5"	13.94	13.98	5.53	8.50	9.53	8-5/8-11 UNC	B5121E500L-BBC	1533.60
6"	14.45	13.98	5.53	9.50	11.02	8-5/8-11 UNC	B5121E600L-BBC	1601.80
8"	17.17	16.60	7.29	11.75	13.19	8-5/8-11 UNC	B5121E800L-BBC	2929.70
10"	19.21	19.17	8.06	14.25	15.94	12-7/8-9 UNC	B5121E1000L-BBC	4062.00
12"	22.87	25.28	9.37	17.00	19.09	12-7/8-9 UNC	B5121E1200L-BBC	6658.30

Lug Double Acting

Size	A	B	C	D1	D2	n-H	Part #	Price/E
2"	9.80"	5.87"	3.74"	4.75"	5.95"	4-5/8-11 UNC	B5121E200L-BCC	\$623.10
2½"	10.75"	5.87"	3.74"	5.50"	6.97"	4-5/8-11 UNC	B5121E250L-BCC	664.70
3"	10.99"	5.87"	3.74"	6.00"	7.56"	4-5/8-11 UNC	B5121E300L-BCC	694.50
4"	11.73"	5.87"	3.74"	7.50"	8.35"	8-5/8-11 UNC	B5121E400L-BCC	814.80
5"	13.15"	7.20"	4.69"	8.50"	9.53"	8-5/8-11 UNC	B5121E500L-BCC	1079.10
6"	13.66"	7.20"	4.69"	9.50"	11.02"	8-5/8-11 UNC	B5121E600L-BCC	1117.30
8"	15.79"	10.22"	5.53"	11.75"	13.19"	8-5/8-11 UNC	B5121E800L-BCC	1690.90
10"	17.05"	10.22"	5.53"	14.25"	15.94"	12-7/8-9 UNC	B5121E1000L-BCC	2105.80
12"	20.20"	11.98"	7.29"	17.00"	19.09"	12-7/8-9 UNC	B5121E1200L-BCC	3329.30

Actuated Valve Accessories

Limit Switches

Valves



XLS-B4A0120P pictured

Features:

- visual position indicator
- 3D open/close indication
- quick-set cam
- mechanical SPDT switches (standard)
- multipoint terminal strip
- various switch options available
- cable entry: (2) 1/2" NPT

Enclosures available:

- NEMA 4 4/X
- water and dust tight for indoor or outdoor use
 - corrosion resistant
- NEMA 7
- water and dust tight for indoor or outdoor use
 - corrosion resistant
 - for use in indoor hazardous locations
 - explosion proof

Enclosure	Part #	Price/E
NEMA 4/4X	XLS-B4A0120P	\$355.56
NEMA 7	XLS-C7A0120P	694.10

Solenoids

Features:

- pressure range: **30 PSI to 150 PSI**
- duty cycle: 100% extended duty
- voltages available: 12VDC, 24VDC, 24VAC, 48VAC, 110VAC, 220VAC
- electroless nickel plated spool
- easy-to-use manual override
- port sizes: inlet and exhaust 1/4" NPT
- NEMA 4 4/X Enclosure
 - water and dust tight for indoor or outdoor use
 - corrosion resistant



Description	Voltage	Part #	Price/E
single coil	115VAC	XSO-4S4D-0A	\$242.95
single coil	24VDC	XSO-4S4B-0A	242.95
dual coil	115VAC	XSO-4D4D-0A	403.46
dual coil	24VDC	XSO-4D4B-0A	340.77

Positioners

Features:

- air capacity:
 - at 29 PSI (200kPa): 9.5 SCFM
 - at 87 PSI (600kPa): 28.3 SCFM
 - at 145 PSI (1MPa): 47.1 SCFM
 - air connections: 1/4" NPT
 - gauges: 1/8" NPT
 - cable entry: 1/2" NPT
- Electro-Pneumatic
- input range: 4-20mA (Ri<250ohms)
 - supply pressure: 21.8 to 145 PSI (0.15 to 1MPa)
 - linearity error: <1.0% f.s
 - hysteresis: <0.6% f.s
 - repeatability: <0.5% f.s
- Pneumatic
- input range: 3 to 15 PSI (20-100kPa)
 - supply pressure: < 145 PSI (<1MPa)
 - linearity error: <0.7% f.s
 - hysteresis: <0.4% f.s
 - repeatability: <0.3% f.s



Positioner Type	Part #	Price/E
Electro-Pneumatic	XPO-E4F	\$3012.82
Pneumatic	XPO-P4F	1474.36

Drum Plug Wrenches

Features:

- sparkproof, natural finish is safe around flammables
- offset handle design reduces user stress and minimizes knuckle injury

Bronze		Aluminum	
Part #	Price/E	Part #	Price/E
DPW	\$106.50	ADPW	\$42.50

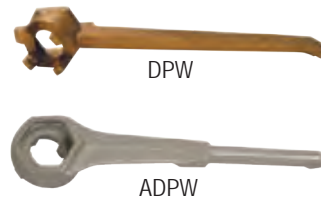

Valves

Drum Faucets

Polyethylene Drum Faucets

Features:

- Faucets are *not* to be used in applications where temperatures exceed 140°F (60°C).
- no wrench needed for screwing into drum opening
- 2" faucet is shipped with a gasket; the ¾" does not require a gasket

NPT Thread	Gold Polyethylene	
	Part #	Price/E
¾"	PEDF75	\$10.80
2"	PEDF200	56.75



Stainless Heavy Duty Adjustable Drum Faucet

Features:

- ¾" NPT connection
- adjustable shank is designed to easily adjust to proper drain position after installing in drum
- PTFE gasket
- FM approved for use with oils and non-flammables

Stainless Steel	
Part #	Price/E
HDSSF75	\$565.00



Brass Heavy Duty Adjustable Drum Faucet

Features:

- ¾" NPT connection
- easy to use, self-closing design
- FM approved for use with oils and non-corrosive flammables

Brass	
Part #	Price/E
AHDBF75	\$229.25



Brass Heavy Duty Drum Faucet with Rigid Shank

Features:

- ¾" NPT connection
- easy to use, self-closing design
- PTFE gasket
- FM approved for use with oils and non-corrosive flammables

Brass	
Part #	Price/E
HDBF75	\$183.50



Compression Bibb Faucets

Application:

- for water use only

Features:

- rough brass finish
- nozzle end is GHT

Male NPT Inlet	Brass	
	Part #	Price/E
½"	35-201-10	\$32.50
¾"	35-202-10	32.50



Drum Thread Adapter

Application:

- for use in gravity discharge from drums

Features:

- male NPSH thread with gasket on the drum side allows for a connection to drums with female NPSH thread
- male NPT end allows for a connection with the female NPT found on most ball valves



Size	Cast Brass	
	Part #	Price/E
2" x 2"	DMH20DR20	\$68.00

Valves

Drum Gate Valves

Application:

- ideal for drawing non-flammable liquids from drums and tanks

Features:

- iron body
- manually operated
- machined and lapped brass faceplate designed for oval discharge, ensures no splashing and a smooth operation
- black Japanned finish
- can be padlocked



Male NPT	Iron	
	Part #	Price/E
3/4"	D71	\$87.00
2"	D75	117.00

Features:

- lightweight, durable aluminum body provides improved corrosion resistance for certain fluids
- sturdy 2" handle is stamped metal with black enamel finish
- can be padlocked



Male NPT	Aluminum	
	Part #	Price/E
2"	D75AL	\$169.00

Self-Closing Gate Valves

Application:

- ideal for dispensing viscous liquids such as oil, grease, paint, varnish and syrups from drums and tanks

Features:

- gray iron body, brass sliding gate and machine lapped sealing surface
- gate closes automatically when handle is released, cleaning discharge surface
- can be padlocked



Male NPT	Iron	
	Part #	Price/E
3/4"	D71SC	\$137.00
2"	D75SC	340.00

Threaded Pipe Fittings J-2 to J-28

NPT threaded bell reducers.....	J-2, J-3
Adapters	J-3
NPT threaded couplings - both ends	J-4
Merchant couplings	J-4
Threaded unions.....	J-5
NPT threaded reducing union.....	J-5
Hex couplings.....	J-5
Reducer hex bushings.....	J-6, J-7
Adapters	J-7
Nipples.....	J-8 to J-11
Pipe.....	J-8, J-9
Adapters.....	J-8
Close.....	J-9, J-10
Hex.....	J-10
Adapters.....	J-11
90° Elbows	J-12 to J-14
NPT threaded.....	J-12
Female pipe	J-12
NPT threaded reducing.....	J-13
Street	J-13
NPT threaded street.....	J-14
45° Elbows	J-15
Tees	J-16 to J-18
NPT threaded female.....	J-16
Female extruded	J-16
Reducing.....	J-17
Street service.....	J-17
Bull head.....	J-17
Side outlet.....	J-17
Street	J-18
Male branch	J-18
Crosses	J-18
Caps	J-19
Plugs.....	J-20
Schedule 80 plastic fittings.....	J-21 to J-24
Tuff-Lite™ plastic fittings	J-21 to J-24
Bulkhead.....	J-25
Bolted fittings.....	J-26
Swage nipples	J-27
Bull plugs.....	J-28

Hammer Unions J-29 to J-31

Series 100, 200, 206, 400, 602, 1002, 1502	J-29 to J-31
Hookie hook lifters	J-31

Weld to Metal Hose Fittings J-32

Wrench Grips..... J-33

Pipe Couplings J-34, J-35

Strab Grip-L.....	J-34
Straub Open-Flex	J-35

Flanges & Flange Adapters J-36, J-37

150 lb. ASA.....	J-36, J-37
King™ turned back weld-to-metal hose nipples	J-37

Grooved Fittings J-38 to J-50

Quick release.....	J-38
Standard couplings.....	J-39
Lightweight flexible	J-40
Lite® couplings	J-41
Rigid couplings	J-42
Bolted clamps	J-43
Painted iron clamps with Baylast™ gaskets.....	J-43
Mechanical tees.....	J-44
Flange adapters.....	J-45
ANSI split flange	J-45
Reducing adapters	J-45
End fittings.....	J-46
Caps	J-47
Nipples.....	J-47
Butterfly valves	J-47
Gaskets	J-48
Accessories	J-49
High density polyethylene couplings	J-50

Line Strainers J-51

Y line.....	J-51
Polypropylene T line	J-51

LP Gas Fittings..... J-52 to J-54

Adapters	J-52
Couplings.....	J-53
Gaskets	J-53
Spanner wrench	J-53
Caps and plugs.....	J-54

Tubing Fittings J-55 to J-78

Instrumentation.....	J-55 to J-58
Compression	J-59 to J-64
Brass SAE 45° flare.....	J-65 to J-67
Flareless bite	J-68 to J-70
Sharkbite® push to connect	J-71 to J-72
LIQUIfit™	J-73 to J-76
TrueSeal™ ball valves.....	J-77 to J-78

Fire Adapters & Connections J-79 to J-129

Double female hex adapters..... J-79

Female rocker lug - suction with poly screen J-79

Female swivel adapters..... J-80

 Pin lug..... J-80

 Rocker lug..... J-80

Double female swivels with pin lugs J-81

Aluminum female swivels with rocker lug..... J-82, J-83

Aluminum double female swivels with long handle J-83

Hydrant adapters J-84 to J-87

 Pin lugs J-84, J-86, J-87

 Rocker lugs..... J-85, J-87

 Long handle J-85

Hazmat with pin lugs J-86

Hex nipples..... J-87 to J-89

Single male outlet with hex..... J-88

Female x male with rocker lug..... J-90 to J-91

Brass female swivel to male J-92

 Pin lugs J-92

 Rocker lugs..... J-92

Male rocker lug - suction J-93

Female swivel to male with rocker lug..... J-94

Female swivel to male with long handle..... J-94

Double male hex nipple J-95 to J-96

Double male with pin and rocker lug J-97

Double male with rocker lugs J-98

Cam & groove hydrant adapters..... J-99

Caps J-100 to J-104

 Brass with pin and rocker lugs..... J-100

 Brass test..... J-100

 Aluminum rocker lug and long handle with cable..... J-101

 Aluminum test..... J-101

 Thermoplastic J-102

 Breakable..... J-103

 Specialty J-104

Plugs..... J-104, J-105

 FDC..... J-104

 Adjust-A-Plug..... J-104

 Brass with pin and rocker lug..... J-105

Brass replacement swivels and accessories..... J-106

Storz J-107 to J-112

 Rigid female..... J-107

 Female swivel with rocker lug and long handle J-108

 Rigid male..... J-109

 Female swivel 30° elbow J-110

 150 lbs. flange..... J-110

 Storz x storz..... J-111

 Accessories..... J-112

Fire Adapters & Connections (cont.) . J-79 to J-129

Wrenches J-113 to J-116

Long handle short shank suction hose females J-117

Angle and suction elbows..... J-117

Continuous swivel elbows J-117

Pump test headers J-118

Hydrant diffusers J-118

Roof connections..... J-119 to J-121

 Two way male outlet J-119 to J-120

 Three way male outlet..... J-121

Sleeve for sidewalk connections J-121

Identification plates..... J-122

British instantaneous J-123 to J-124

International shore connections..... J-125

Dry hydrants J-126

Strainers J-127 to J-131

 Low level with siphon jet J-127

 Barrel and basket..... J-128

 Floating J-129

 Tank round hole J-129

Sanitary Tube Fittings J-130 to J-195

Clamps J-130 to J-132

Clamp accessories J-132

Clamp fittings..... J-133 to J-141

 Ferrules..... J-133, J-134

 Caps..... J-135

 Adapters..... J-135 to J-138

 Elbows J-138, J-139

 Tees J-140

 Reducers..... J-141

 Crosses..... J-141

 Miscellaneous configurations..... J-142

 Covers..... J-142

 Quick weld ferrules J-143

 Breakaway couplings..... J-143

 Gaskets..... J-144 to J-149

Cam and groove transition J-150

Dixon® weld to tube cam and groove..... J-150

European fittings..... J-151 to J-154

Bevel seat..... J-155 to J-159

 Hex nuts..... J-155

 Hex wrenches J-155

 Ferrules..... J-156, J-157

End caps..... J-157

 Adapters..... J-157

 Elbows J-158

 Reducers..... J-158

 Breakaway couplings..... J-158

 Gaskets..... J-159



Sanitary Tube Fittings (cont.) J-130 to J-195

I-line / Q-line J-160 to J-164

- Clamps..... J-160
- Ferrules..... J-161, J-162
- End caps..... J-162
- Gaskets..... J-163, J-164

Pipe size J-165 to J-168

- Clamps..... J-165
- Ferrules..... J-165, J-166
- End caps..... J-166
- Adapters..... J-167
- Hangers J-168
- Gaskets..... J-169

Polished weld J-170 to J-176

- Elbows J-171, J-172
- Sweep elbows..... J-172
- Tees J-173
- Adapters..... J-174
- Reducers..... J-174
- Crosses..... J-175
- Miscellaneous configurations..... J-175

Unpolished weld J-176 to J-180

- Elbows J-176, J-177
- End caps..... J-177
- Adapters..... J-177
- Tees J-178
- Reducers..... J-179
- Type A stub ends..... J-179
- Miscellaneous configurations..... J-180
- Flanges J-181

Spray balls..... J-182

Sight glasses J-183

Compact sight glasses J-184

Swivels J-185

Pressure gauges J-186

Strainers J-187, J-188

Tube Hangers..... J-189, J-190

Wall Flanges..... J-190

High Purity Biopharm fittings J-191 to J-196

Technical Information.....J-197

NPT Threaded Bell Reducers

Features:

- other sizes available
- 304 stainless steel fittings are also available, consult Dixon® for pricing and availability



300# iron



150# iron



150# galvanized iron

Female NPT	Female NPT	300# Iron		150# Iron		150# Galvanized Iron	
		Part #	Price/E	Part #	Price/E	Part #	Price/E
1/4"	1/8"	---	---	BR1418	\$4.05	---	---
3/8"	1/8"	---	---	BR3818	4.05	---	---
	1/4"	---	---	BR3825	4.05	---	---
1/2"	1/4"	300BR5025	\$25.15	BR5025	3.70	BR5025G	\$4.60
	3/8"	---	---	BR5038	3.50	BR5038G	4.30
3/4"	1/4"	---	---	BR7525	4.60	---	---
	3/8"	---	---	BR7538	4.60	---	---
1"	1/2"	300BR7550	25.70	BR7550	4.00	BR7550G	5.00
	3/4"	---	---	BR1025	7.10	---	---
1 1/4"	1/4"	---	---	BR1038	7.20	---	---
	3/8"	---	---	BR1050	6.25	BR1050G	8.35
1 1/2"	1/2"	---	---	BR1075	6.25	BR1075G	7.75
	3/4"	---	---	BR1250	8.95	---	---
2"	1"	300BR1210	40.35	BR1275	7.80	---	---
	1 1/4"	---	---	BR1210	7.80	BR1210G	10.60
2 1/2"	3/4"	---	---	BR1575	12.90	---	---
	1"	300BR1510	55.35	BR1510	11.40	BR1510G	13.70
3"	1 1/4"	300BR1512	62.95	BR1512	9.85	BR1512G	12.90
	1 1/2"	---	---	BR2075	16.30	---	---
3 1/2"	1"	300BR2010	80.20	BR2010	15.40	BR2010G	18.60
	1 1/4"	300BR2012	94.50	BR2012	16.30	---	---
4"	1 1/2"	300BR2015	79.50	BR2015	14.25	BR2015G	18.65
	2"	---	---	BR2510	41.50	---	---
4 1/2"	1"	---	---	BR2515	42.40	---	---
	1 1/2"	---	---	BR2520	36.40	BR2520G	57.75
5"	1"	---	---	BR3010	57.75	---	---
	1 1/4"	---	---	BR3012	61.80	---	---
5 1/2"	1 1/2"	---	---	BR3015	56.50	---	---
	2"	---	---	BR3020	47.00	BR3020G	72.25
6"	2 1/2"	---	---	BR3025	56.50	BR3025G	76.50
	1"	---	---	BR4010	113.50	---	---
6 1/2"	1 1/2"	---	---	BR4015	114.00	---	---
	2"	---	---	BR4020	114.00	---	---
7"	2 1/2"	---	---	BR4025	114.00	---	---
	3"	---	---	BR4030	114.00	BR4030G	165.75
7 1/2"	3"	---	---	BR6030	285.00	---	---
	4"	---	---	BR6040	285.00	---	---

• For additional information on pipe dimensions please reference dixonvalve.com.

NPT Threaded Bell Reducers

Features:

- other sizes available
- 304 stainless steel fittings are also available, consult Dixon® for pricing and availability

Female NPT	Female NPT	150# 316 Stain.Steel		3000# Forged Steel		125# Brass	
		Part #	Price/E	Part #	Price/E	Part #	Price/E
1/4"	1/8"	---	---	---	---	---	---
3/8"	1/8"	---	---	---	---	---	---
	1/4"	BR3825SS	\$6.80	---	---	---	---
1/2"	1/4"	BR5025SS	9.25	---	---	---	---
	3/8"	BR5038SS	8.60	BR5038FS	\$9.40	BR5038B¹	\$10.50
3/4"	3/8"	BR7538SS	11.85	---	---	3771206C	11.91
	1/2"	BR7550SS	11.10	BR7550FS	11.15	BR7550B¹	15.50
1"	1/2"	BR1050SS	16.80	---	---	BR1050B	26.00
	3/4"	BR1075SS	16.80	BR1075FS	14.60	BR1075B	25.40
1 1/4"	1"	BR1210SS	22.00	---	---	BR1210B	41.00
1 1/2"	3/4"	---	---	---	---	BR1575B	64.60
	1"	BR1510SS	29.25	BR1510FS	27.55	BR1510B	51.70
2"	1 1/4"	BR1512SS	29.25	BR1512FS	27.55	---	---
	1"	BR2010SS	49.50	BR2010FS	39.95	BR2010B	86.50
2 1/2"	1 1/2"	BR2015SS	49.95	BR2015FS	39.95	BR2015B	77.00
	2"	---	---	---	---	BR2520B	134.50
3"	2"	BR3020SS	146.00	---	---	BR3020B	180.20
4"	3"	---	---	---	---	BR4030B	428.25



150# 316 stainless steel



3000# forged steel



125# brass

Pipe, Welding & Tube Fittings

¹ items will be discontinued as stock is depleted

Adapters

Reducer Couplings

Feature:

- ref SAE 130138

Female NPTF	Previous Part #	Brass			Optional Qty	Lead Free Brass ^{1,2,3}	
		Part #	Price/E			Part #	Price/E
1/4" x 1/8"	RC2F1F	3770402C	\$4.80	50	---	---	
3/8" x 1/8"	RC3F1F	3770602C	7.69	50	---	---	
3/8" x 1/4"	RC3F2F	3770604C	5.34	50	---	---	
1/2" x 1/4"	RC4F2F	3770804C	7.32	25	---	---	
1/2" x 3/8"	RC4F3F	3770806C	7.09	10	3770806CLF	\$17.74	
3/4" x 3/8"	RC6F3F	3771206C	11.91	10	---	---	
3/4" x 1/2"	RC6F4F	3771208C	11.66	10	3771208CLF	23.18	



¹ lead free brass <=0.25% lead; Alloy CA2745; Alloy C46400

² conforms To: Safe Water Drinking Act (SWDA) of Jan. 4, 2014; California AB1953; RoHS Compliant

³ NPT threads

• For additional information on pipe dimensions please reference dixonvalve.com.

NPT Threaded Couplings



300# iron



150# iron



150# galvanized iron



150# 316 stainless steel



3000# forged steel



125# brass

Female NPT	300# Iron		150# Iron		150# Galvanized Iron	
	Part #	Price/E	Part #	Price/E	Part #	Price/E
1/8"	---	---	<i>RHC18</i>	\$4.95	<i>RHC18G</i>	\$5.75
1/4"	<i>300RHC25</i>	\$15.80	<i>RHC25</i>	4.20	<i>RHC25G</i>	5.35
3/8"	<i>300RHC38</i>	15.80	<i>RHC38</i>	4.20	<i>RHC38G</i>	5.35
1/2"	<i>300RHC50</i>	17.65	<i>RHC50</i>	3.40	<i>RHC50G</i>	4.30
3/4"	<i>300RHC75</i>	20.25	<i>RHC75</i>	4.00	<i>RHC75G</i>	4.95
1"	<i>300RHC100</i>	23.20	<i>RHC100</i>	6.05	<i>RHC100G</i>	8.15
1 1/4"	<i>300RHC125</i>	27.55	<i>RHC125</i>	7.80	<i>RHC125G</i>	11.25
1 1/2"	<i>300RHC150</i>	41.25	<i>RHC150</i>	10.40	<i>RHC150G</i>	12.80
2"	<i>300RHC200</i>	59.40	<i>RHC200</i>	15.10	<i>RHC200G</i>	18.60
2 1/2"	---	---	<i>RHC250</i>	41.00	---	---
3"	---	---	<i>RHC300</i>	55.75	<i>RHC300G</i>	76.00
4"	---	---	<i>RHC400</i>	111.00	<i>RHC400G</i>	161.50
5"	---	---	<i>RHC500</i>	436.90	---	---
6"	---	---	<i>RHC600</i>	297.75	---	---

Female NPT	150# 316 Stain.Steel		3000# Forged Steel		125# Brass	
	Part #	Price/E	Part #	Price/E	Part #	Price/E
1/4"	<i>RHC25SS</i>	\$4.55	<i>RHC25FS</i>	\$7.55	<i>RHC25B</i>	\$8.55
3/8"	<i>RHC38SS</i>	5.70	<i>RHC38FS</i>	7.55	<i>RHC38B</i>	7.75
1/2"	<i>RHC50SS</i>	7.65	<i>RHC50FS</i>	4.75	<i>RHC50B</i>	9.65
3/4"	<i>RHC75SS</i>	11.35	<i>RHC75FS</i>	6.15	<i>RHC75B</i>	12.70
1"	<i>RHC100SS</i>	15.85	<i>RHC100FS</i>	10.75	<i>RHC100B</i>	19.25
1 1/4"	<i>RHC125SS</i>	21.15	<i>RHC125FS</i>	17.85	<i>RHC125B</i>	31.00
1 1/2"	<i>RHC150SS</i>	29.65	<i>RHC150FS</i>	23.15	<i>RHC150B</i>	40.90
2"	<i>RHC200SS</i>	43.70	<i>RHC200FS</i>	38.00	<i>RHC200B</i>	67.30
3"	<i>RHC300SS</i>	114.40	---	---	---	---
4"	<i>RHC400SS</i>	177.75	---	---	---	---

Merchant Couplings

- other sizes are also available, consult Dixon® for pricing



Female NPSM	Black Iron	
	Part #	Price/E
1/4"	<i>MRCH25</i>	\$3.70
3/8"	<i>MRCH38</i>	4.45
1/2"	<i>MRCH50</i>	4.75
3/4"	<i>MRCH75</i>	6.00
1"	<i>MRCH100</i>	8.40
1 1/4"	<i>MRCH125</i>	10.75
1 1/2"	<i>MRCH150</i>	13.60
2"	<i>MRCH200</i>	19.50
3"	<i>MRCH300</i> ¹	77.80

¹ has female NPT thread

• For additional information on pipe dimensions please reference dixonvalve.com.

NPT Threaded Unions

Features:

- other sizes are also available
- 304 stainless steel fittings are also available, consult Dixon® for pricing and availability

Female NPT	300# Iron		150# Iron		150# Galvanized Iron	
	Part #	Price/E	Part #	Price/E	Part #	Price/E
1/8"	---	---	MIU18	\$18.10	---	---
1/4"	---	---	MIU25	17.20	---	---
3/8"	---	---	MIU38	11.60	TUN038G	\$13.75
1/2"	300MIU50	\$29.30	MIU50	11.10	TUN050G	13.90
3/4"	300MIU75	32.45	MIU75	13.25	TUN075G	16.50
1"	300MIU100	42.35	MIU100	17.30	TUN100G	20.50
1 1/4"	---	---	MIU125	22.90	TUN125G	27.80
1 1/2"	300MIU150	72.25	MIU150	28.00	TUN150G	35.75
2"	---	---	MIU200	42.25	TUN200G	47.60
2 1/2"	---	---	MIU250	102.00	---	---
3"	300MIU300	373.25	MIU300	123.75	---	---
4"	---	---	MIU400	306.00	---	---

Female NPT	150# 316 Stainless Steel		3000# Forged Steel		125# Brass	
	Part #	Price/E	Part #	Price/E	Part #	Price/E
1/4"	TUN025SS	\$19.20	---	---	TUN2F	\$27.50
3/8"	TUN038SS	22.50	---	---	TUN3F	27.50
1/2"	TUN050SS	21.25	TUN050FS	\$20.10	TUN4F	29.90
3/4"	TUN075SS	27.00	TUN075FS	33.05	TUN5F	41.00
1"	TUN100SS	41.40	TUN100FS	43.20	TUN6F	54.50
1 1/4"	TUN125SS	70.00	---	---	TUN7F	79.50
1 1/2"	TUN150SS	79.00	TUN150FS	60.80	TUN8F	94.70
2"	TUN200SS	101.90	TUN200FS	82.35	TUN9F	145.00



300# iron

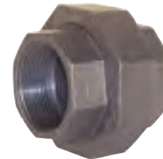

150# iron



150# galvanized iron



150# 316 stainless steel



3000# forged steel



brass

Pipe, Welding & Tube Fittings

NPT Threaded Reducing Union

Female NPT	Female NPT	Part #	Price/E
3/4"	1/2"	MIRU7550	\$21.50



Female Hex Couplings

Feature:

- ref SAE 130138

NPTF	Brass			Pkg Qty	Lead Free Brass ^{1,2,3}	
	Previous Part #	Part #	Price/E		Part #	Price/E
1/8" x 1/8"	BA1F1F	3710202C	\$3.14	25	3710202CLF	\$10.51
1/4" x 1/4"	BA2F2F	3710404C	4.85	25	3710404CLF	11.70
3/8" x 3/8"	BA3F3F	3710606C	5.70	25	3710606CLF	17.48
1/2" x 1/2"	BA4F4F	3710808C	8.70	25	3710808CLF	19.76
3/4" x 3/4"	BA6F6F	3711212C	15.38	10	---	---



¹ lead free brass <=0.25% lead; Alloy CA2745; Alloy C46400
² conforms To: Safe Water Drinking Act (SWDA) of Jan. 4, 2014; California AB1953; RoHS Compliant
³ NPT threads

• For additional information on pipe dimensions please reference dixonvalve.com.

NPT Threaded Reducer Hex Bushings



150# iron



150# galvanized iron



150# 316 stainless steel

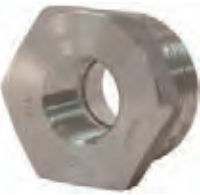

3000# forged steel



125# brass

Male NPT	Female NPT	150# Iron		150# Galvanized Iron		150# 316 Stainless Steel	
		Part #	Price/E	Part #	Price/E	Part #	Price/E
1/4"	1/8"	HB2518	\$4.50	HB2518G	\$6.45	HB2518SS	\$3.70
3/8"	1/8"	HB3818	4.50	---	---	---	---
	1/4"	HB3825	4.50	HB3825G	6.45	HB3825SS	4.25
1/2"	1/8"	HB5018	4.50	---	---	---	---
	1/4"	HB5025	4.50	HB5025G	6.45	HB5025SS	5.45
	3/8"	HB5038	4.50	HB5038G	6.45	HB5038SS	5.45
3/4"	1/8"	HB7518	4.40	---	---	---	---
	1/4"	HB7525	4.40	HB7525G	6.65	HB7525SS	8.10
	3/8"	HB7538	4.40	HB7538G	7.40	HB7538SS	8.10
	1/2"	HB7550	4.05	HB7550G	6.00	HB7550SS	8.65
1"	1/8"	HB1018	5.10	---	---	---	---
	1/4"	HB1025	5.45	HB1025G	7.90	HB1025SS	12.20
	3/8"	HB1038	5.60	HB1038G	12.40	HB1038SS	11.85
	1/2"	HB1050	4.20	HB1050G	7.15	HB1050SS	11.45
	3/4"	HB1075	4.20	HB1075G	6.75	HB1075SS	11.45
1 1/4"	1/2"	HB1250	6.00	---	---	---	---
	3/4"	HB1275	5.40	---	---	HB1275SS	20.50
	1"	HB1210	5.40	HB1210G	9.15	HB1210SS	20.50
1 1/2"	1/2"	HB1550	6.85	---	---	---	---
	3/4"	HB1575	6.85	HB1575G	13.25	HB1575SS	24.15
	1"	HB1510	6.00	HB1510G	11.90	HB1510SS	24.15
	1 1/4"	HB1512	6.85	HB1512G	11.00	HB1512SS	24.15
2"	1/2"	HB2050	10.30	HB2050G	16.50	---	---
	3/4"	HB2075	8.75	HB2075G	15.40	HB2075SS	35.90
	1"	HB2010	8.20	HB2010G	14.50	HB2010SS	35.90
	1 1/4"	HB2012	8.20	HB2012G	14.50	HB2012SS	35.90
	1 1/2"	HB2015	9.15	HB2015G	12.75	HB2015SS	38.40
2 1/2"	1 1/2"	HB2515	13.80	---	---	---	---
	2"	HB2520	13.75	HB2520G	20.80	HB2520SS	64.40
3"	1"	HB3010	20.60	---	---	---	---
	1 1/2"	HB3015	20.20	---	---	---	---
	2"	HB3020	18.90	HB3020G	28.00	HB3020SS	94.40
	2 1/2"	HB3025	19.10	---	---	HB3025SS	92.15
4"	1"	HB4010	39.40	---	---	---	---
	1 1/2"	HB4015	39.40	---	---	---	---
	2"	HB4020	37.25	HB4020G	58.25	HB4020SS	162.00
	2 1/2"	HB4025	37.25	---	---	---	---
	3"	HB4030	37.25	HB4030G	61.75	HB4030SS	162.00
5"	4"	HB5040	68.00	---	---	---	
6"	3"	HB6030	98.50	---	---	---	---
	4"	HB6040	98.50	---	---	---	---

Male NPT	Female NPT	3000# Forged Steel		125# Brass	
		Part #	Price/E	Part #	Price/E
1/4"	1/8"	HB2518FS	\$3.50	---	---
3/8"	1/8"	---	---	---	---
	1/4"	HB3825FS	3.50	---	---
1/2"	1/8"	---	---	---	---
	1/4"	HB5025FS	3.50	---	---
	3/8"	HB5038FS	3.50	---	---
3/4"	1/8"	---	---	---	---
	1/4"	HB7525FS	4.30	---	---
	3/8"	HB7538FS	4.30	---	---
	1/2"	HB7550FS	4.30	---	---
1"	1/4"	HB1025FS	7.00	---	---
	3/8"	HB1038FS	7.00	---	---
	1/2"	HB1050FS	7.00	---	---
	3/4"	HB1075FS	7.00	---	---
1 1/4"	3/4"	HB1275FS	11.35	---	---
	1"	HB1210FS	11.35	HB1210B	\$21.60
1 1/2"	3/4"	HB1575FS	13.15	HB1575B	33.75
	1"	HB1510FS	13.15	HB1510B	27.60
	1 1/4"	HB1512FS	13.15	HB1512B	27.60
	1/2"	---	---	HB2050B	49.50
2"	3/4"	HB2075FS	19.70	HB2075B	49.50
	1"	HB2010FS	19.70	HB2010B	49.15
	1 1/4"	HB2012FS	19.70	HB2012B	40.90
	1 1/2"	HB2015FS	19.70	HB2015B	40.90
	1/2"	---	---	HB2515B	84.25
2 1/2"	2"	HB2520FS	61.60	HB2520B	82.00
	2"	HB3020FS	95.30	HB3020B	123.75
3"	2 1/2"	HB3025FS	95.30	HB3025B	123.65
	2"	---	---	HB4020B	371.15
4"	3"	HB4030FS	206.50	HB4030B	283.45

• For additional information on pipe dimensions please reference dixonvalve.com.

Reducer Hex Bushings

Feature:

- ref SAE 130140

Female NPTF	Male NPTF	Brass			Optional Qty	Lead Free Brass ^{2,3,4}	
		Previous Part #	Part #	Price/E		Part #	Price/E
1/8"	1/4"	HB1F2M	3730402C	\$2.10	100	3730402CLF	\$4.30
1/8"	3/8"	HB1F3M	3730602C	3.30	100	---	---
1/4"	3/8"	HB2F3M	3730604C	2.73	100	3730604CLF	6.06
1/8"	1/2"	HB1F4M	3730802C	4.79	25	---	---
1/4"	1/2"	HB2F4M	3730804C	4.27	50	3730804CLF	11.67
3/8"	1/2"	HB3F4M	3730806C	3.61	50	3730806CLF	10.05
1/8"	3/4"	HB1F6M	3731202C ¹	7.70	25	---	---
1/4"	3/4"	HB2F6M	3731204C	7.85	25	---	---
3/8"	3/4"	HB3F6M	3731206C	6.95	25	---	---
1/2"	3/4"	HB4F6M	3731208C	7.20	25	3731208CLF	15.53
1/4"	1"	HB2F8M	3731604C ¹	15.50	10	---	---
3/8"	1"	HB3F8M	3731606C ¹	14.86	10	---	---
1/2"	1"	HB4F8M	3731608C	14.08	10	---	---
3/4"	1"	HB6F8M	3731612C	11.60	10	---	---



Pipe, Welding & Tube Fittings

- ¹ SAE does not provide a standard for these sizes
- ² lead free brass <=0.25% lead; Alloy CA2745; Alloy C46400
- ³ conforms To: Safe Water Drinking Act (SWDA) of Jan. 4, 2014; California AB1953; RoHS Compliant
- ⁴ NPT threads

Adapters

Female NPT x Male NPT Adapters

Feature:

- ref SAE 130139

Female NPTF	Male NPTF	Brass			Optional Qty	Lead Free Brass ^{1,2,3}	
		Previous Part #	Part #	Price/E		Part #	Price/E
1/8"	1/8"	RA1F1M	3750202C	\$4.03	100	---	---
1/4"	1/8"	RA2F1M	3750402C	4.28	50	3750402CLF	\$8.96
1/4"	1/4"	RA2F2M	3750404C	4.36	50	3750404CLF	12.03
3/8"	1/8"	RA3F1M	3750602C	7.37	50	---	---
3/8"	1/4"	RA3F2M	3750604C	4.75	50	3750604CLF	15.61
3/8"	3/8"	RA3F3M	3750606C	5.98	50	---	---
1/2"	1/4"	RA4F2M	3750804C	7.05	25	---	---
1/2"	3/8"	RA4F3M	3750806C	6.21	25	---	---
1/2"	1/2"	RA4F4M	3750808C	7.73	25	3750808CLF	25.38
3/4"	3/8"	RA6F3M	3751206C	13.43	10	---	---
3/4"	1/2"	RA6F4M	3751208C	10.65	10	---	---
3/4"	3/4"	RA6F6M	3751212C	13.61	10	3751212CLF	38.25



- ¹ lead free brass <=0.25% lead; Alloy CA2745; Alloy C46400
- ² conforms To: Safe Water Drinking Act (SWDA) of Jan. 4, 2014; California AB1953; RoHS Compliant
- ³ NPT threads

Pump Adapters

Features:

- used to convert BSP pump outlets to NPT
- hard-coated, extruded 6061-T6 aircraft aluminum alloy
- other sizes, configurations are available, contact Dixon®

Female BSP	Male NPT	Aluminum	
		Part #	Price/E
1 1/2"	1 1/2"	AHA15BSP15T	\$105.70
2"	2"	AHA20BSP20T	138.50
2 1/2"	2 1/2"	AHA25BSP25T	95.00
3"	3"	AHA30BSP30T	207.05
4"	4"	AHA40BSP40T	286.40



- For additional information on pipe dimensions please reference dixonvalve.com.

Pipe Nipples

Long Pipe Nipples

- carbon steel and stainless steel nipples are available on page J-9



NPT	Length	Brass			Optional Qty	Lead Free Brass ^{1,2}	
		Previous Part #	Part #	Price/E		Part #	Price/E
1/8"	1 1/2"	166-0215	1660215C	\$2.51	25	---	---
1/8"	2"	166-0220	1660220C	3.47	25	---	---
1/8"	2 1/2"	166-0225	1660225C	4.22	25	---	---
1/8"	3"	166-0230	1660230C	4.26	25	1660230CLF	\$10.59
1/8"	3 1/2"	166-0235	1660235C	4.67	10	---	---
1/8"	4"	166-0240	1660240C	5.63	10	1660240CLF	8.47
1/4"	1 1/2"	166-0415	1660415C	3.92	25	1660415CLF	6.44
1/4"	2"	166-0420	1660420C	4.94	25	1660420CLF	9.27
1/4"	2 1/2"	166-0425	1660425C	6.57	25	---	---
1/4"	3"	166-0430	1660430C	6.00	25	1660430CLF	16.40
1/4"	3 1/2"	166-0435	1660435C	6.50	10	---	---
1/4"	4"	166-0440	1660440C	6.83	10	1660440CLF	11.39
1/4"	5"	166-0450	1660450C	8.58	5	---	---
3/8"	1 1/2"	166-0615	1660615C	3.87	25	1660615CLF	8.47
3/8"	2"	166-0620	1660620C	5.12	25	1660620CLF	11.42
3/8"	2 1/2"	166-0625	1660625C	7.90	10	1660625CLF	14.89
3/8"	3"	166-0630	1660630C	7.83	10	1660630CLF	17.56
3/8"	3 1/2"	166-0635	1660635C	9.17	10	---	---
3/8"	4"	166-0640	1660640C	10.55	5	1660640CLF	19.53
1/2"	1 1/2"	166-0815	1660815C	5.50	10	1660815CLF	10.38
1/2"	2"	166-0820	1660820C	6.30	10	---	---
1/2"	2 1/2"	166-0825	1660825C	9.45	10	---	---
1/2"	3"	166-0830	1660830C	11.31	10	---	---
1/2"	3 1/2"	166-0835	1660835C	11.79	10	---	---
1/2"	4"	166-0840	1660840C	11.90	5	---	---
3/4"	2"	166-1220	1661220C	9.40	5	---	---
3/4"	2 1/2"	166-1225	1661225C	12.00	5	---	---
3/4"	3"	166-1230	1661230C	13.04	5	---	---
3/4"	3 1/2"	166-1235	1661235C	13.70	5	---	---
1"	2"	---	TN100X2B	21.00	---	---	---
1"	3"	---	TN100X3B	31.50	---	---	---
1"	4"	---	TN100X4B	42.00	---	---	---
1 1/2"	2"	---	TN150X2B	34.15	---	---	---
1 1/2"	3"	---	TN150X3B	47.00	---	---	---
2"	3"	---	TN200X3B	63.00	---	---	---
2"	4"	---	TN200X4B	84.00	---	---	---
2"	6"	---	TN200X6B	116.30	---	---	---

¹ lead free brass <=0.25% lead; Alloy CA2745; Alloy C46400

² conforms To: Safe Water Drinking Act (SWDA) of Jan. 4, 2014; California AB1953; RoHS Compliant

Female NPTF x Male NPSM Adapters



Female NPTF	Male NPSM	Brass			Optional Qty
		Previous Part #	Part #	Price/E	
1/4"	1/4"	174-0404	1740404C	\$5.47	100
3/8"	3/8"	174-0606	1740606C	4.99	50
1/2"	1/2"	174-0808	1740808C	7.48	50

- For additional information on pipe dimensions please reference dixonvalve.com.

Pipe Nipples - Threaded Both Ends

Features:

- made from schedule 40 welded pipe
- male NPT x male NPT design
- brass nipples are available, see page J-8
- other lengths are also available, consult Dixon® for pricing

Note: do not use pipe nipples as hose inserts.



Male NPT	Overall Length	Carbon Steel		316 Stainless Steel	
		Part #	Price/E	Part #	Price/E
1/4"	2"	TN025X2	\$2.45	---	---
1/4"	6"	---	---	TN025X6SS	\$16.80
3/8"	2"	TN038X2	2.70	---	---
3/8"	4"	TN038X4	4.05	---	---
3/8"	6"	TN038X6	6.45	---	---
1/2"	2"	TN050X2	2.10	TN050X2SS	9.75
1/2"	3"	TN050X3	2.50	TN050X3SS	13.80
1/2"	4"	TN050X4	2.95	TN050X4SS	19.80
1/2"	6"	TN050X6	3.90	TN050X6SS	31.20
3/4"	2"	TN075X2	2.60	TN075X2SS	12.20
3/4"	3"	TN075X3	2.95	TN075X3SS	15.50
3/4"	4"	TN075X4	3.60	TN075X4SS	20.25
3/4"	6"	TN075X6	5.15	TN075X6SS	35.15
1"	2"	TN100X2	3.80	TN100X2SS	16.40
1"	3"	TN100X3	4.05	TN100X3SS	23.00
1"	4"	TN100X4	5.00	TN100X4SS	30.00
1"	6"	TN100X6	7.15	TN100X6SS	47.50
1 1/4"	2"	TN125X2	5.00	TN125X2SS	19.00
1 1/4"	3"	TN125X3	5.05	TN125X3SS	26.75
1 1/4"	4"	TN125X4	6.25	TN125X4SS	35.00
1 1/4"	6"	TN125X6	8.90	TN125X6SS	61.20
1 1/2"	2"	TN150X2	5.90	TN150X2SS	21.75
1 1/2"	3"	TN150X3	6.60	TN150X3SS	31.50
1 1/2"	4"	TN150X4	7.40	TN150X4SS	41.00
1 1/2"	6"	TN150X6	10.35	TN150X6SS	71.80
2"	3"	TN200X3	8.55	TN200X3SS	41.00
2"	4"	TN200X4	10.35	TN200X4SS	53.00
2"	5"	TN200X5	12.00	TN200X5SS	66.00
2"	6"	TN200X6	13.95	TN200X6SS	94.15
2"	8"	TN200X8	23.35	---	---
3"	3"	TN300X3	30.05	TN300X3SS	91.00
3"	4"	TN300X4	35.60	TN300X4SS	116.00
3"	6"	TN300X6	42.65	TN300X6SS	191.20
4"	4"	TN400X4	48.15	TN400X4SS	148.00
4"	6"	TN400X6	58.75	TN400X6SS	255.75
4"	8"	TN400X8	81.00	---	---
6"	6"	TN600X6	170.00	---	---
6"	8"	TN600X8	210.00	---	---



carbon steel



stainless steel

Close Pipe Nipples

NPT	Brass			Optional Qty	Lead Free Brass ^{1,2}	
	Previous Part #	Part #	Price/E		Part #	Price/E
1/8"	165-0202	1650202C	\$1.62	50	1650202CLF	\$3.24
1/4"	165-0404	1650404C	2.20	50	1650404CLF	4.74
3/8"	165-0606	1650606C	2.52	100	1650606CLF	6.56
1/2"	165-0808	1650808C	6.29	25	1650808CLF	8.03
3/4"	165-1212	1651212C	9.60	25	1651212CLF	13.54
1"	165-1616	1651616C	12.70	25	---	---
1 1/2"	---	CN150B	31.75	5	---	---
2"	---	CN200B	48.35	5	---	---
3"	---	CN300B	173.40	5	---	---



¹ lead free brass <=0.25% lead; Alloy CA2745; Alloy C46400

² conforms To: Safe Water Drinking Act (SWDA) of Jan. 4, 2014; California AB1953; RoHS Compliant

• For additional information on pipe dimensions please reference dixonvalve.com.

Close Nipples

Features:

- made from schedule 40 welded pipe
- male NPT x male NPT design



Male NPT	Overall Length	Carbon Steel		Galvanized		316 Stainless Steel		Optional Qty
		Part #	Price/E	Part #	Price/E	Part #	Price/E	
1/8"	3/4"	---	---	---	---	CN012SS	\$4.25	1
1/4"	7/8"	CN025	\$2.40	CN025G	\$2.70	CN025SS	4.75	25
3/8"	1"	CN037	2.50	---	---	CN037SS	5.85	25
1/2"	1 1/8"	CN050	2.10	CN050G	2.40	CN050SS	7.80	10
3/4"	1 3/8"	CN075	2.40	CN075G	2.95	CN075SS	10.10	10
1"	1 1/2"	CN100	3.50	CN100G	4.00	CN100SS	14.00	10
1 1/4"	1 5/8"	CN125	4.40	---	---	---	---	10
1 1/2"	1 7/8"	CN150	5.50	CN150G	6.30	CN150SS	23.70	10
2"	2"	CN200	7.45	CN200G	9.35	CN200SS	36.75	10
2 1/2"	2 1/2"	CN250	23.25	---	---	---	---	--
3"	2 5/8"	CN300	27.60	CN300G	31.45	CN300SS	98.80	1
4"	2 3/4"	CN400	41.60	---	---	CN400SS	133.45	5
6"	3 1/8"	CN600	126.75	---	---	---	---	--

Hex Nipples

Feature:

- ref SAE 130137



NPTF	Previous Part #	Brass			Lead Free Brass ^{1,2,3}	
		Part #	Price/E	Optional Qty	Part #	Price/E
1/8" x 1/8"	BCN12	3700202C	\$3.00	100	3700202CLF	\$4.47
1/4" x 1/4"	BCN25	3700404C	2.81	100	3700404CLF	7.63
3/8" x 3/8"	BCN37	3700606C	4.32	50	3700606CLF	9.95
1/2" x 1/2"	BCN50	3700808C	5.70	25	3700808CLF	17.81
3/4" x 3/4"	BCN75	3701212C	7.50	20	---	---
1" x 1"	BCN100	3701616C	18.00	10	---	---

¹ lead free brass <=0.25% lead; Alloy CA2745; Alloy C46400

² conforms To: Safe Water Drinking Act (SWDA) of Jan. 4, 2014; California AB1953; RoHS Compliant

³ NPT threads

Straight Hex Nipples



Male NPT	316 Stainless Steel		
	Part #	Price/E	Optional Qty
3/8"	HN38SS	\$5.30	
1/2"	HN50SS	9.50	
3/4"	HN75SS	11.90	
1"	HN100SS	16.50	
1 1/2"	HN150SS	29.35	
2"	HN200SS	41.90	

Reducer Hex Nipples

Feature:

- ref SAE 130137



Male NPTF	Brass			Optional Qty
	Previous Part #	Part #	Price/E	
1/4" x 1/8"	HN2M1M	3790402C	\$3.53	100
3/8" x 1/8"	HN3M1M	3790602C	5.62	50
3/8" x 1/4"	HN3M2M	3790604C	4.24	50
1/2" x 1/4"	HN4M2M	3790804C	5.50	50
1/2" x 3/8"	HN4M3M	3790806C	5.57	50
3/4" x 1/2"	HN6M4M	3791208C	8.65	25



Male NPT	Male NPT	316 Stainless Steel	
		Part #	Price/E
3/8"	1/4"	RHN3825SS	\$6.05
1/2"	3/8"	RHN5038SS	6.90
3/4"	1/2"	RHN7550SS	10.20

Note: do not use pipe nipples as hose inserts. 

- For additional information on pipe dimensions please reference dixonvalve.com.



Adapters

Ball Seat to Male Pipe

NPSM	NPTF	Previous Part #	Brass		Optional Qty
			Part #	Price/E	
1/8"	1/8"	BSM11	1720202C	\$2.40	100
1/4"	1/8"	BSM21	1720402C	3.20	100
1/4"	1/4"	BSM22	1720404C	2.61	100
3/8"	1/4"	BSM32	1720604C	4.25	100
3/8"	3/8"	BSM33	1720606C	4.24	50
3/8"	1/2"	BSM34	1720608C	8.43	50
1/2"	3/8"	BSM43	1720806C	4.94	50
1/2"	1/2"	BSM44	1720808C	5.80	50
3/4"	3/4"	BSM66	1721212C	7.82	25



Pipe, Welding
& Tube Fittings

Male Unions

NPSM	NPSM	Previous Part #	Brass		Pkg Qty
			Part #	Price/E	
1/8"	1/8"	176-0202	1760202C	\$3.11	100
1/4"	1/4"	176-0404	1760404C	3.82	100
3/8"	3/8"	176-0606	1760606C	6.23	100
1/2"	1/2"	176-0808	1760808C	7.33	50



- For additional information on pipe dimensions please reference dixonvalve.com.



NPT Threaded 90° Threaded Elbows



300# iron



150# iron



150# galvanized iron



150# 316 stainless steel



2000# forged steel



125# brass

Features:

- other sizes are also available
- 304 stainless steel fittings are also available, consult Dixon® for pricing and availability

Female NPT	300# Iron		150# Iron		150# Galvanized Iron	
	Part #	Price/E	Part #	Price/E	Part #	Price/E
1/8"	---	---	EL9018	\$3.55	EL9018G	\$4.85
1/4"	300EL9025	\$17.55	EL9025	3.35	EL9025G	4.60
3/8"	300EL9038	15.60	EL9038	3.35	EL9038G	4.60
1/2"	300EL9050	20.15	EL9050	2.50	EL9050G	3.05
3/4"	300EL9075	22.80	EL9075	3.05	EL9075G	3.65
1"	300EL90100	30.80	EL90100	5.35	EL90100G	6.85
1 1/4"	300EL90125	42.45	EL90125	8.65	EL90125G	10.50
1 1/2"	300EL90150	50.05	EL90150	11.40	EL90150G	13.90
2"	300EL90200	72.00	EL90200	19.50	EL90200G	23.10
2 1/2"	---	---	EL90250	42.30	---	---
3"	---	---	EL90300	63.00	EL90300G	96.90
4"	---	---	EL90400	134.00	EL90400G	167.50
5"	---	---	EL90500	298.00	---	---
6"	---	---	EL90600	502.00	---	---

Female NPT	150# 316 Stain. Steel		2000# Forged Steel		125# Brass	
	Part #	Price/E	Part #	Price/E	Part #	Price/E
1/8"	EL9018SS	\$6.40	---	---	---	---
1/4"	EL90025SS	6.40	EL9025FS	\$10.40	---	---
3/8"	EL90038SS	7.80	EL9038FS	11.95	---	---
1/2"	EL90050SS	8.60	EL9050FS	10.50	---	---
3/4"	EL90075SS	12.50	EL9075FS	11.45	---	---
1"	EL90100SS	17.60	EL90100FS	14.65	EL90100B	\$24.50
1 1/4"	EL90125SS	26.80	EL90125FS	29.25	---	---
1 1/2"	EL90150SS	35.90	EL90150FS	35.70	EL90150B	48.00
2"	EL90200SS	47.35	EL90200FS	48.95	EL90200B	75.10
3"	EL90300SS	149.00	---	---	---	---
4"	EL90400SS	251.00	---	---	---	---

90° Female Pipe Elbows - Extruded

Feature:

- ref SAE 130238



brass



lead free brass

Female NPTF	Brass			Optional Qty	Lead Free Brass ^{1, 2, 3}	
	Previous Part #	Part #	Price/E		Part #	Price/E
1/8"	EL1F1F	302020C	\$4.50	25	---	---
1/4"	EL2F2F	302040C	7.11	25	302040CLF	\$26.79
3/8"	EL3F3F	302060C	9.69	25	302060CLF	26.46
1/2"	EL4F4F	302080C	17.85	25	302080CLF	26.25
3/4"	EL6F6F	302121C	26.50	10	302121CLF	79.08

¹ lead free brass <=0.25% lead; Alloy CA2745; Alloy C46400

² conforms To: Safe Water Drinking Act (SWDA) of Jan. 4, 2014; California AB1953; RoHS Compliant

³ NPT thread

- For additional information on pipe dimensions please reference dixonvalve.com.

NPT Threaded Reducing Elbows

Feature:

- other sizes are also available, consult Dixon® for pricing and availability

Female NPT	Female NPT	Part #	Price/E
		<i>150# Iron</i>	
1/4"	1/8"	REL2518	\$6.55
1/2"	1/4"	REL5025	4.70
1/2"	3/8"	REL5038	4.60
3/4"	1/2"	REL7550	4.75
1"	1/2"	REL1050	6.45
1"	3/4"	REL1075	6.10
1 1/4"	1"	REL1210	9.90
1 1/2"	1"	REL1510	16.25
1 1/2"	1 1/4"	REL1525	16.25
2"	1"	REL2010	23.40
2"	1 1/2"	REL2015	20.60
2 1/2"	2"	REL2520	56.30
3"	2"	REL3020	91.00
4"	2"	REL4020	156.00
4"	3"	REL4030	156.00



Pipe, Welding
& Tube Fittings

90° Street Elbows - Extruded

Feature:

- ref SAE 130239

Female NPTF	Male NPTF	Previous Part #	Brass		Optional Qty	Lead Free Brass ^{1,2}	
			Part #	Price/E		Part #	Price/E
1/8"	1/8"	SE1F1M	3040202C	\$4.41	25	3040202CLF	\$16.58
1/4"	1/8"	SE2F1M	3040402C	6.43	25	---	---
1/4"	1/4"	SE2F2M	3040404C	7.03	25	3040404CLF	9.34
3/8"	1/4"	SE3F2M	3040604C	8.59	25	---	---
3/8"	3/8"	SE3F3M	3040606C	9.71	25	3040606CLF	12.96
1/2"	3/8"	SE4F3M	3040806C	15.55	25	---	---
1/2"	1/2"	SE4F4M	3040808C	17.35	25	3040808CLF	24.67
3/4"	1/2"	SE6F4M	3041208C	20.77	25	---	---
3/4"	3/4"	SE6F6M	3041212C	25.95	10	---	---



brass



lead free brass

¹ lead free brass <=0.25% lead; Alloy CA2745; Alloy C46400

² conforms To: Safe Water Drinking Act (SWDA) of Jan. 4, 2014; California AB1953; RoHS Compliant

³ NPT thread

90° Male Pipe Elbows - Forged

Male NPTF	Previous Part #	Brass		Optional Qty
		Part #	Price/E	
1/8"	169-0202	1690202C	\$3.45	25
1/4"	169-0404	1690404C	4.76	25
3/8"	169-0606	1690606C	6.85	25
1/2"	169-0808	1690808C	11.45	25



- For additional information on pipe dimensions please reference dixonvalve.com.

NPT Threaded 90° Street Elbows



150# iron

Features:

- other sizes are also available
- 304 stainless steel fittings are also available, consult Dixon® for pricing and availability



150# galvanized iron



150# 316 stainless steel

Male NPT	Female NPT	150# Iron		150# Galvanized Iron		150# 316 Stain. Steel	
		Part #	Price/E	Part #	Price/E	Part #	Price/E
1/8"	1/8"	SE9018	\$5.05	SE9018G	\$6.55	SE9018SS	\$8.60
1/4"	1/4"	SE9025	5.05	SE9025G	6.30	SE9025SS	8.75
3/8"	3/8"	SE9038	5.05	SE9038G	6.30	SE9038SS	10.80
1/2"	1/2"	SE9050	5.20	SE9050G	6.50	SE9050SS	12.70
3/4"	3/4"	SE9075	5.05	SE9075G	6.30	SE9075SS	16.70
1"	1"	SE9010	7.30	SE9010G	8.60	SE9010SS	26.75
1 1/4"	1 1/4"	SE9012	11.10	SE9012G	14.40	SE9012SS	39.75
1 1/2"	1 1/2"	SE9015	14.90	SE9015G	17.80	SE9015SS	52.00
2"	2"	SE9020	24.00	SE9020G	30.75	SE9020SS	64.00
2 1/2"	2 1/2"	SE90250	59.50	---	---	---	---
3"	3"	SE90300	90.75	SE9030G	126.00	---	---
4"	4"	SE90400	147.80	---	---	---	---
6"	6"	SE90600	486.60	---	---	---	---



3000# forged steel



125# brass

Male NPT	Female NPT	3000# Forged Steel		125# Brass	
		Part #	Price/E	Part #	Price/E
1/8"	1/8"	---	---	---	---
1/4"	1/4"	SE9025FS	\$22.15	---	---
3/8"	3/8"	SE9038FS	21.30	---	---
1/2"	1/2"	SE9050FS	21.30	---	---
3/4"	3/4"	SE9075FS	26.95	SE9075B	\$20.50
1"	1"	SE9010FS	35.95	SE9010B	33.75
1 1/4"	1 1/4"	SE9012FS	65.10	SE9012B	51.70
1 1/2"	1 1/2"	SE9015FS	78.70	SE9015B	67.50
2"	2"	SE9020FS	113.50	SE9020B	114.50

• For additional information on pipe dimensions please reference dixonvalve.com.

NPT Threaded 45° Threaded Elbows

Female NPT	150# Iron	
	Part #	Price/E
1/8"	EL4518	\$5.10
1/4"	EL4525	5.20
3/8"	EL4538	4.70
1/2"	EL4550	4.10
3/4"	EL4575	5.00
1"	EL45100	6.35
1 1/4"	EL45125	11.10
1 1/2"	EL45150	13.75
2"	EL45200	20.75
2 1/2"	EL45250	58.40
3"	EL45300	75.90
4"	EL45400	147.25
5"	EL45500	488.25
6"	EL45600	502.00



Pipe, Welding
& Tube Fittings

NPT Threaded 45° Street Elbows

Size	150# Iron		150# Galvanized Iron	
	Part #	Price/E	Part #	Price/E
1/8"	SE4518	\$7.85	---	---
1/4"	SE4525	5.90	SE4525G	\$7.75
3/8"	SE4538	6.65	---	---
1/2"	SE4550	5.35	SE4550G	6.80
3/4"	SE4575	8.25	SE4575G	11.10
1"	SE45100	9.55	---	---
1 1/4"	SE45125	16.50	SE45125G	20.50
1 1/2"	SE45150	20.50	SE45150G	24.75
2"	SE45200	34.60	SE45200G	42.50
2 1/2"	SE45250	73.50	SE45250G	100.00
3"	SE45300	112.60	SE45300G	149.50
4"	SE45400	211.00	SE45400G	243.10



150# galvanized iron

Elbows

45° Street Elbows - Extruded

Feature:

- ref SAE 130339

Female NPTF	Male NPTF	Previous Part #	Brass		Optional Qty
			Part #	Price/E	
1/8"	1/8"	306-0202	3060202C	\$4.55	25
1/4"	1/4"	306-0404	3060404C	4.91	25
3/8"	3/8"	306-0606	3060606C	7.55	25
1/2"	1/2"	306-0808	3060808C	13.23	25
3/4"	3/4"	306-1212	3061212C	21.45	10



• For additional information on pipe dimensions please reference dixonvalve.com.

NPT Threaded Female Tees



300# iron



150# iron



150# galvanized iron



150# 316 stainless steel



2000# forged steel



125# brass

Female NPT	300# Iron		150# Iron		150# Galvanized Iron	
	Part #	Price/E	Part #	Price/E	Part #	Price/E
1/8"	---	---	FT18	\$5.55	---	---
1/4"	300FT25	\$22.05	FT25	5.05	FT25G	\$6.00
3/8"	300FT38	23.35	FT38	5.05	FT38G	6.00
1/2"	300FT50	29.70	FT50	3.30	FT50G	3.70
3/4"	---	---	FT75	4.65	FT75G	6.20
1"	300FT10	38.60	FT10	8.20	FT100G	10.10
1 1/4"	300FT120	55.30	FT120	13.30	FT120G	16.00
1 1/2"	---	---	FT15	16.50	FT150G	20.00
2"	300FT200	95.15	FT200	28.00	FT200G	33.30
2 1/2"	---	---	FT250	57.70	---	---
3"	---	---	FT30	86.60	FT300G	104.90
4"	---	---	FT40	203.40	FT400G	247.90
5"	---	---	FT500	548.25	---	---
6"	---	---	FT60	581.10	---	---

Female NPT	150# 316 Stainless Steel		2000# Forged Steel		125# Brass	
	Part #	Price/E	Part #	Price/E	Part #	Price/E
1/8"	---	---	---	---	---	---
1/4"	FT25SS	\$8.00	FT25FS	\$13.25	---	---
3/8"	FT38SS	10.60	---	---	---	---
1/2"	FT50SS	11.20	FT50FS	12.70	---	---
3/4"	FT75SS	16.50	FT75FS	17.20	FT75B	\$19.40
1"	FT10SS	23.40	FT100FS	23.90	FT10B	34.50
1 1/4"	FT120SS	41.00	FT120FS	42.20	---	---
1 1/2"	FT150SS	50.00	FT150FS	51.10	FT15B	66.10
2"	FT200SS	65.00	FT200FS	63.90	FT20B	108.25

Female Tees - Extruded

Feature:

- ref SAE 130438



brass



lead free brass

NPTF Thread	Brass			Optional Qty	Lead Free Brass ^{1,2,3}	
	Previous Part #	Part #	Price/E		Part #	Price/E
1/8"	322-0202	3220202C	\$5.00	25	3220202CLF	\$20.17
1/4"	322-0404	3220404C	8.60	25	3220404CLF	16.86
3/8"	322-0606	3220606C	11.61	25	3220606CLF	25.71
1/2"	322-0808	3220808C	22.28	25	3220808CLF	34.06
3/4"	322-1212	3221212C	29.60	10	3221212CLF	124.45

¹ lead free brass <=0.25% lead; Alloy CA2745; Alloy C46400

² conforms To: Safe Water Drinking Act (SWDA) of Jan. 4, 2014; California AB1953; RoHS Compliant

³ NPT thread

- For additional information on pipe dimensions please reference dixonvalve.com.

NPT Threaded Side Outlet Elbows

Female NPT	150# Iron	
	Part #	Price/E
1/8"	SOE18	\$11.10
1/4"	SOE25	11.10
3/8"	SOE38	11.10
1/2"	SOE50	11.10
3/4"	SOE75	11.90
1"	SOE100	30.45
1 1/4"	SOE120	26.60
1 1/2"	SOE150	35.65
2"	SOE200	68.50



Pipe, Welding
& Tube Fittings

NPT Threaded Female Reducing Tees

Female NPT	Female NPT	150# Iron	
		Part #	Price/E
3/8"	1/4"	FRT3825	\$6.75
1/2"	3/8"	FRT5038	7.00
3/4"	1/2"	FRT7550	7.15
1"	1/2"	FRT1050	9.15
1 1/4"	1"	FRT1210	14.50
1 1/2"	1"	FRT1510	18.30
2"	1"	FRT2010	28.70
2"	1 1/2"	FRT2015	30.25
3"	2"	FRT3020	100.25



NPT Threaded Street Service Tees

NPT	150# Iron	
	Part #	Price/E
1/2"	SST50	\$11.75
3/4"	SST75	15.90
1"	SST100	21.00
1 1/2"	SST150	48.00



NPT Threaded Bull Head Tees

Female NPT	Female NPT	150# Iron	
		Part #	Price/E
1/2"	3/4"	BHT1575	\$8.15
1/2"	1"	BHT1510	11.90
3/4"	1"	BHT7510	10.40
1"	1 1/2"	BHT1015	28.75
1"	2"	BHT1020	35.20
1 1/2"	2"	BHT1520	35.20
2"	2 1/2"	BHT2025	75.25



NPT Threaded Side Outlet Tees

Female NPT	150# Iron	
	Part #	Price/E
1/2"	SOT50	\$14.40
3/4"	SOT75	18.55
1"	SOT100	33.65
1 1/4"	SOT120	46.60
1 1/2"	SOT150	49.75
2"	SOT200	76.50



• For additional information on pipe dimensions please reference dixonvalve.com.

Street Tees - Extruded

Feature:

- ref SAE 130424



Female NPTF	Male NPTF	Previous Part #	Brass		Optional Qty	Lead Free Brass ^{1, 2, 3}	
			Part #	Price/E		Part #	Price/E
1/8"	1/8"	326-0202	3260202C	\$5.15	25	---	---
1/4"	1/4"	326-0404	3260404C	8.25	25	3260404CLF	\$40.03
3/8"	3/8"	326-0606	3260606C	11.40	25	---	---
1/2"	1/2"	326-0808	3260808C	22.30	25	---	---
3/4"	3/4"	326-1212	3261212C	34.80	10	---	---

¹ lead free brass <=0.25% lead; Alloy CA2745; Alloy C46400

² conforms To: Safe Water Drinking Act (SWDA) of Jan. 4, 2014; California AB1953; RoHS Compliant

³ NPT thread

Male Branch Tees - Extruded

Feature:

- ref SAE 130425



NPTF	Previous Part #	Brass		Optional Qty	Lead Free Brass ^{1, 2, 3}	
		Part #	Price/E		Part #	Price/E
1/8"	324-0202	3240202C	\$5.96	25	---	---
1/4"	324-0404	3240404C	9.25	25	---	---
3/8"	324-0606	3240606C	11.61	25	3240606CLF	\$46.88
1/2"	324-0808	3240808C	20.83	25	---	---
3/4"	324-1212	3241212C	35.19	10	---	---

¹ lead free brass <=0.25% lead; Alloy CA2745; Alloy C46400

² conforms To: Safe Water Drinking Act (SWDA) of Jan. 4, 2014; California AB1953; RoHS Compliant

³ NPT thread

NPT Threaded Crosses



Female NPT	150# Iron	
	Part #	Price/E
1/8"	MIC18	\$12.10
1/4"	MIC25	10.30
3/8"	MIC38	10.50
1/2"	MIC50	11.90
3/4"	MIC75	14.50
1"	MIC100	17.90
1 1/4"	MIC125	29.00
1 1/2"	MIC150	36.00
2"	MIC200	59.50
2 1/2"	MIC250	105.00
3"	MIC300	156.50
4"	MIC400	319.50

Pipe Crosses - Extruded



Female NPTF	Previous Part #	Brass		Optional Qty
		Part #	Price/E	
1/8"	228-0202	2280202C	\$6.34	25
1/4"	228-0404	2280404C	10.67	25
3/8"	228-0606	2280606C	12.93	25
1/2"	228-0808	2280808C	27.50	10
3/4"	228-1212	2281212C	41.45	10

- For additional information on pipe dimensions please reference dixonvalve.com.

NPT Threaded Caps

Features:

- other sizes are also available
- 304 stainless steel fittings are also available, consult Dixon® for pricing and availability

Female NPT	300# Iron		150# Iron	
	Part #	Price/E	Part #	Price/E
1/8"	---	---	MICAP18	\$3.30
1/4"	---	---	MICAP25	3.30
3/8"	---	---	MICAP38	3.30
1/2"	300MICAP50	\$16.10	MICAP50	2.50
3/4"	300MICAP75	20.25	MICAP75	3.40
1"	300MICAP100	26.60	MICAP100	4.10
1 1/4"	300MICAP125	29.45	MICAP120	5.35
1 1/2"	300MICAP150	43.05	MICAP150	7.30
2"	300MICAP200	59.75	MICAP200	9.55
2 1/2"	---	---	MICAP250	23.70
3"	---	---	MICAP300	35.20
4"	---	---	MICAP400	55.00
5"	---	---	MICAP500	115.50
6"	---	---	MICAP600	219.50



300# iron



150# iron



150# galvanized iron



150# 316 stainless steel

Female NPT	150# Galvanized Iron		150# 316 Stainless Steel	
	Part #	Price/E	Part #	Price/E
1/8"	---	---	SSCAP18	\$3.35
1/4"	---	---	SSCAP25	4.10
3/8"	---	---	SSCAP38	4.90
1/2"	MICAP50G	\$3.20	SSCAP50	5.60
3/4"	MICAP75G	4.60	SSCAP75	7.40
1"	---	---	SSCAP10	9.85
1 1/4"	---	---	SSCAP12	19.50
1 1/2"	---	---	SSCAP15	25.00
2"	MICAP200G	11.80	SSCAP20	36.75

NPT Pipe Caps

Female NPT	Optional Qty	Lead Free Brass ^{1, 2, 3}	
		Part #	Price/E
1/8"	50	2130200CLF	\$3.10
1/4"	100	2130400CLF	3.72
3/8"	25	2130600CLF	6.20
1/2"	25	2130800CLF	10.77
3/4"	25	2131200CLF	15.66



¹ lead free per NSF/ANSI 372

² lead free brass <=0.25% lead; Alloy CA2745; Alloy C46400

³ conforms To: Safe Water Drinking Act (SWDA) of Jan. 4, 2014; California AB1953; RoHS Compliant

• For additional information on pipe dimensions please reference dixonvalve.com.

NPT Threaded Square Head Plugs

Feature:

- forged steel plugs are solid, all others are cored



150# iron



150# galvanized iron



150# 316 stainless steel



3000# forged steel

Male NPT	150# Iron		150# Galvanized Iron		150# 316 Stain. Steel	
	Part #	Price/E	Part #	Price/E	Part #	Price/E
1/8"	SHP18	\$2.15	SHP18G	\$3.30	SHP18SS	\$3.20
1/4"	SHP14	2.15	SHP14G	3.50	SHP14SS	3.40
3/8"	SHP38	2.15	SHP38G	3.50	SHP38SS	3.90
1/2"	SHP50	2.30	SHP50G	4.40	SHP50SS	5.50
3/4"	SHP75	2.30	SHP75G	4.40	SHP75SS	6.75
1"	SHP100	2.90	SHP100G	4.85	SHP100SS	8.75
1 1/4"	SHP125	3.65	SHP125G	7.45	SHP125SS	20.00
1 1/2"	SHP150	5.05	SHP150G	10.00	SHP150SS	22.00
2"	SHP200	7.20	SHP200G	12.75	SHP200SS	30.50
2 1/2"	SHP250	13.10	SHP250G	24.80	SHP250SS	49.00
3"	SHP300	18.00	SHP300G	35.25	SHP300SS	59.50
4"	SHP400	37.80	SHP400G	73.10	SHP400SS	131.00
5"	SHP500	81.00	---	---	---	---
6"	SHP600	131.70	SHP600G	145.10	---	---

Male NPT	3000# Forged Steel		125# Brass	
	Part #	Price/E	Part #	Price/E
1/8"	---	---	2110200C ^{1,2}	\$2.41
1/4"	SHP14FS	\$2.55	2110400C ^{1,2}	4.00
3/8"	SHP38FS	2.65	2110600C ^{1,2}	6.00
1/2"	SHP50FS	2.75	2110800C ^{1,2}	10.88
3/4"	SHP75FS	3.50	2111200C ^{1,2}	16.78
1"	SHP100FS	5.30	SHP100B	16.50
1 1/2"	SHP150FS	12.35	SHP150B	23.00
2"	SHP200FS	19.90	---	---
3"	SHP300FS	84.15	---	---

¹ lead free brass per NSF/ANSI 372, Brass Alloy 260/270

² threads are PTF-SAE

Hex Head Plugs



NPT	Brass			Pkg Qty	Lead Free Brass ^{1,2}	
	Previous Part #	Part #	Price/E		Part #	Price/E
1/8"	HHP1M	1630200C	\$2.23	50	1630200CLF	\$2.36
1/4"	HHP2M	1630400C	2.04	100	1630400CLF	3.16
3/8"	HHP3M	1630600C	2.84	25	---	---
1/2"	HHP4M	1630800C	4.42	25	---	---
3/4"	HHP6M	1631200C	6.62	25	---	---
1"	HHP8M	1631600C	13.10	10	---	---

- standard brass hex head plug is hollow; lead free brass is solid

¹ lead free brass <=0.25% lead; Alloy CA2745; Alloy C46400

² conforms To: Safe Water Drinking Act (SWDA) of Jan. 4, 2014; California AB1953; RoHS Compliant

Hex Socket Plugs



NPTF	Lead Free Brass ¹			Optional Qty
	Previous Part #	Part #	Price/E	
1/8"	219-0200	2190200C	\$1.34	50
1/4"	219-0400	2190400C	2.40	100
3/8"	219-0600	2190600C	3.60	25
1/2"	219-0800	2190800C	6.84	25
3/4"	219-1200	2191200C	10.00	25

¹ lead free brass per NSF/ANSI 372, Brass Alloy 260/270

- For additional information on pipe dimensions please reference dixonvalve.com.

Polypropylene Schedule 80 - Pipe Couplings

Female NPT	Polypropylene	
	Part #	Price/E
3/4"	62238	\$5.45
1"	62239	6.50
1 1/2"	62241	15.00
2"	62194	16.10



Tuff-Lite™ - Female NPT x Female NPT Adapters

- sold in package quantity only

Female NPT	Female NPT	Nylon		Pkg Qty
		Part #	Price/E	
1/2"	1/2"	TA994	\$4.35	25
3/4"	3/4"	TA996	4.70	25



Polypropylene Schedule 80 - Reducer Bushings

Male NPT	Female NPT	Polypropylene	
		Part #	Price/E
1/2"	1/4"	62267	\$3.35
3/4"	1/2"	62272	3.35
1"	1/2"	62275	3.60
1"	3/4"	62276	3.60
1 1/4"	3/4"	62277	3.70
1 1/4"	1"	62278	3.70
1 1/2"	3/4"	62279	5.35
1 1/2"	1"	62280	5.35
1 1/2"	1 1/4"	62281	5.35
2"	3/4"	62195	6.15
2"	1"	62196	6.15
2"	1 1/4"	62197	6.15
2"	1 1/2"	62198	6.15
3"	2"	60330	18.50



Tuff-Lite™ - Male NPT x Female Threaded Swivel Nut Adapters

- female shipped with a red vinyl washer (**TVW7**), replacement washers on page E-47

Male NPT	Female Thread	Nylon	
		Part #	Price/E
1/4"	3/4" GHT	TSA72	\$1.90
3/8"	3/4" GHT	TSA73	1.95
1/4"	3/4" NPS	TSA62	1.90
3/8"	3/4" NPS	TSA63	2.00



Tuff-Lite™ - Reducing Bushings

Male NPT	Female NPT	Nylon	
		Part #	Price/E
3/8"	1/4"	THB32	\$1.90
1/2"	1/4"	THB42	2.00
1/2"	3/8"	THB43	2.00
3/4"	1/2"	THB64	2.35
1"	3/4"	THB86	3.20



- For additional information on pipe dimensions please reference dixonvalve.com.

Tuff-Lite™ - Close Nipples

- sold in package quantity only



Male NPT	Nylon		Pkg Qty
	Part #	Price/E	
1/4"	TCN202	\$0.72	50
3/8"	TCN303	0.81	50
1/2"	TCN404	0.93	50
3/4"	TCN606	1.10	50

Polypropylene Schedule 80 - Hex Nipples



Male NPT	Polypropylene	
	Part #	Price/E
1/2"	62221	\$1.90
3/4"	60554	3.05
1"	60555	3.60
1 1/4"	60556	3.70
1 1/2"	60547	5.25
2"	60548	5.90
3"	61769	20.00

Polypropylene Schedule 80 - Reducer Nipples



Male NPT	Male NPT	Polypropylene	
		Part #	Price/E
3/4"	1/2"	62233	\$2.90
1"	3/4"	62234	3.35
1 1/4"	1"	62235	3.90
1 1/2"	1 1/4"	62236	4.25
2"	1 1/2"	60549	5.05

Polypropylene Schedule 80 - Nipples



Male NPT	Length	Polypropylene	
		Part #	Price/E
3/4"	4"	62223	\$3.60
3/4"	6"	62224	4.40
1"	4"	62225	3.85
1"	6"	62226	4.80
2"	4"	62192	12.60
2"	6"	62193	14.50

- For additional information on pipe dimensions please reference dixonvalve.com.

Polypropylene Schedule 80 - 90° Elbows

Female NPT	Polypropylene	
	Part #	Price/E
1/2"	62215	\$4.90
3/4"	62216	5.60
1"	62217	6.50
1 1/2"	62219	12.90
2"	62191	15.50
3"	62220	74.00



Pipe, Welding
& Tube Fittings

Tuff-Lite™ - Street Female NPT x 90° Male NPT Elbows

Female NPT	Male NPT	Nylon	
		Part #	Price/E
1/4"	1/4"	TSE22	\$4.05
1/2"	1/2"	TSE44	3.90
3/4"	3/4"	TSE66	5.30



Polypropylene Schedule 80 - 90° Street Elbows

NPT Thread	Polypropylene	
	Part #	Price/E
1/2"	62243	\$5.20
3/4"	62244	5.60
1"	62245	6.50
1 1/4"	62246	8.60
1 1/2"	62247	13.20
2"	62199	15.90
3"	62248	74.00



Polypropylene Schedule 80 - Tees

Female NPT	Polypropylene	
	Part #	Price/E
1/2"	62209	\$5.85
3/4"	62210	6.10
1"	62211	8.50
1 1/4"	62212	10.20
1 1/2"	62213	16.00
2"	62190	19.25
3"	62214	84.00



Polypropylene Schedule 80 - Cross

Female NPT	Polypropylene	
	Part #	Price/E
1"	62263	\$25.25



• For additional information on pipe dimensions please reference dixonvalve.com.

Tuff-Lite™ - Female Threaded Swivel Nuts



Female Thread	Part #	Nylon	Price/E
3/4" NPSM	TCF6		\$0.66
3/4" GHT	TCF7		0.62

Tuff-Lite™ - Threaded Caps

- sold in package quantity only



Female Thread	Part #	Nylon	Price/E	Pkg Qty
1/4" NPT	TTC2		\$0.48	50
3/8" NPT	TTC3		0.57	50
1/2" NPT	TTC4		0.71	50
3/4" NPT	TTC6		0.80	50
3/4" GHT	TTC7		0.80	50

Tuff-Lite™ - Hex Head Drain Plugs

- sold in package quantity only



Male NPT	Part #	Nylon	Price/E	Pkg Qty
1/8"	TPX1		\$0.64	50
1/4"	TPX2		0.68	50
3/8"	TPX3		0.71	50
1/2"	TPX4		0.82	50
3/4"	TPX6		0.96	50
1"	TPX8		1.17	50
1 1/4"	TPX10		1.55	25

Tuff-Lite™ - Square Head Drain Plugs

- sold in package quantity only



Male NPT	Part #	Nylon	Price/E	Pkg Qty
1/8"	TPS1		\$0.55	50
1/4"	TPS2		0.57	50
3/8"	TPS3		0.68	50
1/2"	TPS4		0.76	50
3/4"	TPS6		0.90	50
1"	TPS8		1.12	50
1 1/4"	TPS10		1.67	25

Polypropylene Schedule 80 - Pipe Caps



Female NPT	Part #	Polypropylene	Price/E
3/4"	62250		\$6.75
1"	62251		6.75

Polypropylene Schedule 80 - Pipe Plugs



Male NPT	Part #	Polypropylene	Price/E
3/4"	62256		\$3.35
1"	62257		3.35
1 1/4"	62258		3.70
1 1/2"	62259		5.90
2"	62201		6.25

- For additional information on pipe dimensions please reference dixonvalve.com.

Bulkhead Fittings

Application:

- for use on most poly storage tanks and many steel and fiberglass tanks

Features:

- glass reinforced polypropylene provides strength and chemical resistance
- EPDM gaskets are standard
- FKM gaskets are available, contact Dixon® to order

Pipe, Welding
& Tube Fittings

female NPT fittings

Female NPT	Hole Size	Polypropylene	
		Part #	Price/E
1/2"	1-7/16"	62834	\$12.20
3/4"	1-7/16"	60401	9.75
1"	2-1/4"	60427	12.20
1 1/4"	2-1/4"	60403	12.20
1 1/2"	2-3/8"	63931 ¹	14.50
2"	3"	60405	17.50
2"	3"	63481 ²	14.90
2" HD ³	3-1/4"	63683	27.50
3"	4-1/2"	62299 ¹	86.50



¹ 1 1/2" and 3" do not contain a washer
² designed for tank wall thickness less than 3/8" - low profile

Gaskets

Size	EPDM	
	Part #	Price/E
1/2" - 3/4"	60402	\$2.15
1" - 1 1/4"	60404	3.05
1 1/2"	63938	6.55
2"	60406	4.15
2" HD ³	60336	6.45
3"	60331	16.55



³ heavy duty

Bulkhead Couplings

Female NPTF	External Male UNS	Length	Brass	
			Part #	Price/E
1/8"	5/8"	1.50"	207BH2	\$10.26
1/4"	3/4"	1.50"	207BH4	11.97
1/4"	3/4"	.94"	207BH4S	9.65
3/8"	1"	1.31"	207BH6	15.15
1/2"	1-1/8"	1.50"	207BH8	20.60
3/4"	1-5/16"	1.50"	207BH12	107.90



Bolted Fittings

Polypropylene Female NPT fittings

Features:

- Bolts thread into back plate of fitting leaving no welds, holes as potential points of leakage.
- 316 stainless steel bolts
- 2 required, EPDM gaskets are standard (sold separately)
- FKM gaskets are available, contact Dixon®



Size	Polypropylene	
	Part #	Price/E
¾"	60502	\$43.40
1"	60505	43.40
1½"	60513	74.00
2"	60516	74.00

Gaskets



Size	EPDM	
	Part #	Price/E
¾" - 1"	60498	\$6.00
1½" - 2"	60497	5.95

Stainless Steel Female NPT fittings

Features:

- Bolts thread into back plate of fitting leaving no welds, holes as potential points of leakage.
- 316 stainless steel bolts
- required, cross-linked polyethylene gaskets are standard (*sold separately*)
- FKM and EPDM gaskets are available, contact Dixon®



Size	Stainless Steel	
	Part #	Price/E
¾"	63035	\$134.30
1"	62948	137.70
1½"	63037	192.00
2"	63038	203.30

Gaskets



Size	Cross-Linked Polyethylene	
	Part #	Price/E
¾" - 1"	62950	\$4.90
1½"	63042	9.40
2"	62848	10.45

Swage Nipples

Features:

- manufactured in conformance with ASTM A234 and MSS SP-95
- threads on nipples conform to ASME B1.20.1
- schedule 40 nipples have blue caps
- schedule 80 nipples have green caps

Male NPT	Length	Zinc Plated Schedule 40	
		Part #	Price/E
2" x 1"	6.5"	SW40-200100	\$35.15
2" x 1¼"	6.5"	SW40-200125	35.15
2" x 1½"	6.5"	SW40-200150	35.15
2½" x 1"	7"	SW40-250100	47.10
2½" x 1½"	7"	SW40-250150	47.10
2½" x 2"	7"	SW40-250200	38.65
3" x 2"	8"	SW40-300200	43.20
3" x 2½"	8"	SW40-300250	43.20
4" x 2"	9"	SW40-400200	74.35
4" x 2½"	9"	SW40-400250	75.75
4" x 3"	9"	SW40-400300	62.75
6" x 3"	12"	SW40-600300	242.45
6" x 4"	12"	SW40-600400	231.30
8" x 4"	13"	SW40-800400	643.05
8" x 6"	13"	SW40-800600	491.80



Pipe, Welding
& Tube Fittings

Male NPT	Length	Zinc Plated Schedule 80	
		Part #	Price/E
½" x ¼"	2.8"	SW80-050025	\$11.15
½" x ⅜"	2.8"	SW80-050038	11.80
¾" x ½"	3.0"	SW80-075050	13.10
1" x ¼"	3.5"	SW80-100025	14.75
1" x ½"	3.5"	SW80-100050	13.95
1" x ¾"	3.5"	SW80-100075	16.95
2" x ½"	6.5"	SW80-200050	40.95
2" x ¾"	6.5"	SW80-200075	38.80
2" x 1"	6.5"	SW80-200100	34.55
2" x 1¼"	6.5"	SW80-200125	35.15
2" x 1½"	6.5"	SW80-200150	35.15
2½" x 2"	7.0"	SW80-250200	40.35
3" x 1"	8.0"	SW80-300100	77.85
3" x 2"	8.0"	SW80-300200	57.25
3" x 2½"	8.0"	SW80-300250	54.05
4" x 2"	9.0"	SW80-400200	89.55
4" x 3"	9.0"	SW80-400300	83.60
4" x 4"	9.0"	SW80-400400	119.25
6" x 3"	12.0"	SW80-600300	286.05
6" x 4"	12.0"	SW80-600400	279.55
8" x 6"	13.0"	SW80-800600	571.05



• For additional information on pipe dimensions please reference dixonvalve.com.

Bull Plugs



schedule 80

Features:

- manufactured in conformance with ASTM A234 and MSS SP-95
- threads on nipples conform to ASME B1.20.1
- schedule 40 nipples have blue caps
- schedule 80 nipples have green caps

Male NPT	Length	Zinc Plated Schedule 40		Zinc Plated Schedule 80	
		Part #	Price/E	Part #	Price/E
2"	4"	BP40-200	\$30.40	BP80-200	\$29.90
2½"	5"	BP40-250	52.05	BP80-250	54.70
3"	6"	BP40-300	65.10	BP80-300	59.75
4"	7"	BP40-400	89.65	BP80-400	81.90

Bull Plugs with Tap



schedule 40

Features:

- manufactured in conformance with ASTM A234 and MSS SP-95
- threads on nipples conform to ASME B1.20.1
- schedule 40 nipples have blue caps
- schedule 80 nipples have green caps

Male NPT	Length	Zinc Plated Schedule 40		Zinc Plated Schedule 80	
		Part #	Price/E	Part #	Price/E
2" x ¼"	4"	BP40-200T025	\$31.80	BP80-200T025	\$31.80
2" x ½"	5"	BP40-200T050	31.80	BP80-200T050	33.35
3" x ½"	6"	BP40-300T050	64.20	BP80-300T050	69.35
4" x ½"	7"	BP40-400T050	90.95	BP80-400T050	95.70

• For additional information on pipe dimensions please reference dixonvalve.com.

Hammer Unions

Features:

- Socket weld configurations and other materials are available, contact Dixon® for further information.
- Hammer unions work at extremely high pressures. Mismatching components of one series with another (i.e. series 602 with series 1502) can lead to destruction of property, serious bodily injury or death.
- temperature range: **-20°F to 250°F (-29°C to 121°C)**
- non-shocking cold water pressure means that the rated value is the maximum operating pressure at ambient temperature
- no spikes higher than this pressure
- no instantaneous pressure increases (0-2000 PSIG in ¼ of a second)
- ambient temperature: **70°F (21°C)**



100 Series

Features:

- used on low pressure manifolds and lines and in applications running air, water, oil or gas up to **1,000 PSI NSCWP** (non-shock cold working pressure)
- yellow sub, black nut

Size	Configuration	NSCWP (PSI)	Forged Steel	
			Part #	Price/E
2"	threaded	1000	HU100200	\$52.90
2"	butt weld	1000	HU100200BW ¹	82.35
2½"	threaded	1000	HU100250	150.00
3"	threaded	1000	HU100300	139.05
4"	threaded	1000	HU100400	209.45
4"	butt weld	1000	HU100400BW ¹	272.70
6"	threaded	1000	HU100600	722.40
8"	threaded	1000	HU100800	981.65

¹ butt weld ends are schedule 40



200 Series

Features:

- used in general service applications running air, water, oil or gas up to **2,000 PSI NSCWP** (non-shock cold working pressure)
- grey sub, blue nut

Size	Configuration	NSCWP (PSI)	Forged Steel	
			Part #	Price/E
1"	threaded	2000	HU200100	\$35.35
1½"	threaded	2000	HU200150	116.15
2"	threaded	2000	HU200200	51.90
2"	butt weld	2000	HU200200BW ¹	87.10
2½"	threaded	2000	HU200250	229.60
3"	threaded	2000	HU200300	213.75
4"	threaded	2000	HU200400	271.80
6"	threaded	2000	HU200600	981.65
8"	threaded	2000	HU200800	1150.00

¹ butt weld ends are schedule 40



206 Series

Features:

- used in general service applications running air, water, oil and gas up to **2,000 PSI NSCWP** (non-shock cold working pressure)
- O-ring mounted sub provides excellent sealing properties
- grey sub, blue nut

Size	Configuration	NSCWP (PSI)	Forged Steel	
			Part #	Price/E
1"	threaded	2000	HU206100	\$39.15
1½"	threaded	2000	HU206150	101.10
2"	threaded	2000	HU206200	60.20
2½"	threaded	2000	HU206250	224.80
3"	threaded	2000	HU206300	224.30
4"	threaded	2000	HU206400	250.00
6"	threaded	2000	HU206600	1066.10
8"	threaded	2000	HU206800	1600.00



Hammer Unions

400 Series

**Features:**

- used on manifold and line connections, pump, suction and mud service
- up to **4,000 PSI NSCWP** (non-shock cold working pressure)
- red sub, black nut

Size	Configuration	NSCWP (PSI)	Forged Steel	
			Part #	Price/E
2"	threaded	4000	HU400200	\$148.00
3"	threaded	4000	HU400300	305.25
4"	threaded	4000	HU400400	387.45

602 Series

Features:

- for use in mud, manifold service and truck mounting applications running water, oil or mud up to **6,000 PSI NSCWP** (non-shock cold working pressure)
- lip type seal ring minimizes fluid flow turbulence while creating a pressure seal
- orange sub, black nut



Size	Configuration	NSCWP (PSI)	Forged Steel	
			Part #	Price/E
1"	threaded	6000	HU602100	\$116.00
2"	threaded	6000	HU602200	269.20
2"	butt weld	6000	HU602200BW¹	234.85
3"	threaded	6000	HU602300	375.00
3"	butt weld	6000	HU602300BW¹	446.15
4"	threaded	6000	HU602400	550.00
4"	butt weld	6000	HU602400BW¹	704.50

¹ butt weld ends are schedule 80

1002 Series

Features:

- for use in high pressure systems and truck mounting applications running water, oil or mud up to **10,000 PSI NSCWP** (non-shock cold working pressure)
- lip type seal ring minimizes fluid flow turbulence while creating a pressure seal
- blue sub, red nut



Size	Configuration	NSCWP (PSI)	Forged Steel	
			Part #	Price/E
1"	threaded	10000	HU1002100	\$223.15
2"	threaded	10000	HU1002200	293.40
2"	butt weld	10000	HU1002200BW¹	270.00
3"	threaded	10000	HU1002300	450.00
3"	butt weld	10000	HU1002300BW¹	610.55
4"	threaded	10000	HU1002400	758.20
4"	butt weld	10000	HU1002400BW¹	751.45

¹ butt weld ends are schedule XXS

Hammer Unions

1502 Series

Features:

- for use in extreme high pressure applications running water, oil or mud up to **15,000 PSI** NSCWP (non-shock cold working pressure)
- lip type seal ring minimizes fluid flow turbulence while creating a pressure seal
- red sub, blue nut

Size	Configuration	NSCWP (PSI)	Forged Steel	
			Part #	Price/E
2"	threaded	15000	HU1502200	\$303.85
2"	butt weld	15000	HU1502200BW¹	352.25
3"	threaded	15000	HU1502300	670.00
3"	butt weld	15000	HU1502300BW¹	730.30
4"	threaded	15000	HU1502400	1060.50
4"	butt weld	15000	HU1502400BW¹	1268.05



Pipe, Welding
& Tube Fittings

¹ butt weld ends are schedule XXS

Hookie - Hook Hose Lifter

Features:

- for use with hammer unions on pages J-29 - J-31
- safe working load is 4 tons, with a proof load test of 8 tons
- supplied complete with retaining clamp

Size	Forged Steel	
	Part #	Price/E
3"	HA0900-3	\$666.60
4"	HA0900-4	666.60
5"	HA0900-5	727.20



NPT Threaded Pipe Fittings



Size	Overall Length	Carbon Steel		304 Stainless Steel		Aluminum	
		Part #	Price/E	Part #	Price/E	Part #	Price/E
1/4"	2"	PN250	\$4.95	PNS250	\$7.80	---	---
3/8"	2"	PN375	5.50	PNS375	9.95	---	---
1/2"	2"	PN500	4.90	PNS500	11.20	---	---
3/4"	2"	PN750	3.50	PNS750	13.90	---	---
1"	2"	PN1000	5.05	PNS1000	16.70	---	---
1 1/4"	2"	PN1250	7.15	PNS1250	20.85	---	---
1 1/2"	2"	PN1500	6.15	PNS1500	23.70	---	---
2"	2"	PN2000	7.15	PNS2000	33.65	---	---
2 1/2"	3"	PN2500	24.25	PNS2500	78.25	---	---
3"	3"	PN3000	28.00	PNS3000	105.80	APN3000	\$43.25
4"	4"	PN4000	46.00	PNS4000	161.35	APN4000	64.15

Dixon® Hex Nipples for Welding to Metal Hose



carbon steel



machined brass



global stainless

Size	Carbon Steel ¹		Optional Qty	Machined Brass	
	Part #	Price/E		Part #	Price/E
1/4"	FM250	\$3.50	200	FMB250	\$7.00
3/8"	FM375	3.65	100	FMB375	11.15
1/2"	FM500	4.55	50	FMB500	13.90
3/4"	FM750	5.55	50	FMB750	15.60
1"	FM1000	7.30	50	FMB1000	25.90
1 1/4"	FM1250	15.00	50	---	---
1 1/2"	FM1500	15.85	50	---	---
2"	FM2000	39.90	10	---	---

Size	304 Stainless Steel ¹		Optional Qty	316 Stainless Steel ¹	
	Part #	Price/E		Part #	Price/E
1/4"	FMS250	\$9.50	200	---	---
3/8"	FMS375	11.85	100	---	---
1/2"	FMS500²	11.20	50	FMR500²	\$12.75
3/4"	FMS750²	12.60	50	FMR750²	16.45
1"	FMS1000²	19.50	50	FMR1000²	28.20
1 1/4"	FMS1250	60.60	50	---	---
1 1/2"	FMS1500	60.80	50	FMR1500	63.10

¹ Dixon® suggests using 308 LSI welding rod

² global stainless steel

Dixon® Octagonal Nipples for Welding to Metal Hose



Size	Overall Length	Weld-On Length	Hex Length	Carbon Steel		304 Stainless Steel	
				Part #	Price/E	Part #	Price/E
2"	2 1/2"	7/8"	9/16"	OCTOE32	\$28.35	OCTOES32	\$53.85

• For additional information on pipe dimensions please reference dixonvalve.com.

Dixon® Octagonal Wrench Grips

Size	Across Outside Flats	Across Inside Flats	Width	304 Stainless Steel	
				Part #	Price/E
1½"	2.230"	1.910"	9/16"	OCTS24	\$14.30
2"	2.781"	2.385"	9/16"	OCTS32	16.85
3"	3.750"	3.510"	7/8"	OCTS48	37.70

Size	Across Outside Flats	Across Inside Flats	Width	304 Stainless Steel	
				Part #	Price/E
2"	2.740"	2.510"	9/16"	OCT32	\$9.40



Pipe, Welding
& Tube Fittings

Dixon® Weld-On Hex Wrench Grips

Size	Global Investment Cast Steel	
	Part #	Price/E
1"	WN12	\$6.30
1¼"	WN16	5.90
1½"	WN21	5.90
2"	WN26	6.45
2½"	WN31	8.60
3"	WN36	10.40
4"	WN46	21.00



Straub Grip-L Axial Restraint Pipe Couplings

Application:

- suitable for pipes within the lower pressure range, applications include, but are not limited to: ship building, water and waste water treatment plants and industrial process pipe work

Features:

- joins like or dissimilar pipe materials: steel, galvanized, painted, stainless steel, thin-wall stainless steel, PVC, copper
- requires no special tools or pipe-end preparation; only a torque wrench is required for a secure and safe pipe connection that seldom needs retightening
- accommodates up to 5° of pipe misalignment
- vary gap between pipe ends
- absorbs vibration, water hammer and sound
- special patented grip ring for superior holding power on hard-surfaced pipes
- 5 year limited warranty
- reusable
- EPDM sealing sleeve temperature range: - 4°F to 176°F (-20°C to 80°C)
- NBR and FKM sleeves available, contact Dixon® for information

Materials:

- casing: AISI 316Ti; screws: AISI 316 L; bolts: AISI 316 Ti; anchoring ring: AISI 301; sealing sleeve: EPDM standard

Specifications:

- American Bureau of Shipping (ABS) up to **232 PSI** on ¾" - 5"; **188 PSI** on 6"; **145 PSI** on 8"
- Underwriter's Laboratories (UL)
- National Sanitation Foundation (NSF)
- built to ASTM 1476, Type 2, Class 2 specifications

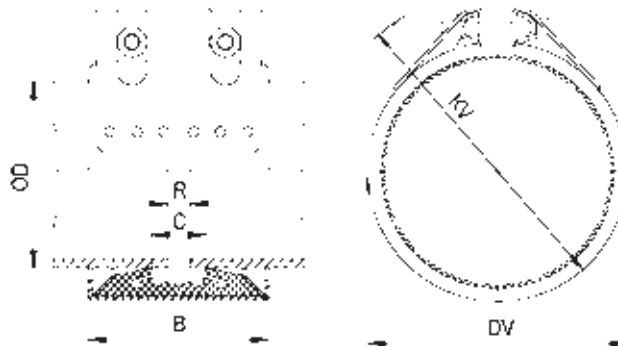

Size	Pipe OD Range		Working Pressure PSI	Coupling Dimensions		Assembled Dimensions		Maximum Distance Between Pipe End R	316 Ti Stainless Steel	
	actual	min to max		B	C	DV	KV		Part #	Price/E
¾"	1.05"	1.04" to 1.08"	670	1.8"	0.7"	1.7"	2.8"	0.2"	STR20000 ¹	\$169.30
1"	1.31"	1.31" to 1.35"	550	1.8"	0.7"	2.0"	3.0"	0.2"	STR20100 ¹	179.30
1½"	1.90"	1.88" to 1.92"	440	2.4"	1.0"	2.6"	3.9"	0.2"	STR20300 ¹	221.95
2"	2.37"	2.35" to 2.40"	320	3.0"	1.5"	3.1"	4.3"	0.4"	STR20450 ¹	259.90
2½"	2.87"	2.85" to 2.90"	450	3.7"	1.6"	3.9"	5.3"	0.4"	STR20500	331.35
3"	3.50"	3.46" to 3.54"	320	3.7"	1.6"	4.4"	5.9"	0.4"	STR20650	365.00
4"	4.50"	4.46" to 4.54"	232	3.7"	1.6"	5.4"	6.7"	0.4"	STR20900	403.65
5"	5.50"	5.51" to 5.62"	232	4.3"	2.1"	6.5"	8.3"	0.4"	STR21150	598.10
6"	6.63"	6.56" to 6.69"	232	4.3"	2.1"	7.6"	9.1"	0.4"	STR21350	650.45
8"	8.63"	8.54" to 8.71"	232	5.6"	3.1"	9.8"	11.6"	0.4"	STR21400	1136.50

¹ only has one bolt

Note: All Straub couplings require the correct use of a torque wrench for a safe and proper installation. Straub couplings must be torqued to the specified value as printed on each individual coupling. Failure to do so can result in serious injury or death.

Not for steam or refrigerant service.



Straub Open-Flex 1L Couplings

Applications:

- suitable for repairing or joining pipes where access to the pipe end is difficult or impossible

Features:

- use to replace bolted sleeve type couplings (AWWA Std. C-219) or for permanent repairs or installation
- wrap-around design differs from similar type repair products because the installation or repair is permanent due to the unique flexible lip seal gasket design
- joins like or dissimilar pipe materials: steel, galvanized, painted, stainless steel, thin-wall stainless steel, PVC, copper
- requires no special tools or pipe-end preparation; only a torque wrench is required for a secure and safe pipe connection that seldom needs retightening
- accommodates up to 5° of pipe misalignment
- vary gap between pipe ends
- absorbs vibration, water hammer, and sound
- acts as an expansion joint; will accept up to .25" of axial movement
- EPDM sealing sleeve temperature range: - 4°F to 176°F (-20°C to 80°C)
- 5 year limited warranty
- reusable

Materials:

- casing: AISI 316Ti; screws: AISI 4135 steel; bolts: AISI 12L 14 galvanized

Specifications:

- American Bureau of Shipping (ABS) up to 232 PSI
- Underwriter's Laboratories (UL)
- National Sanitation Foundation (NSF)
- conforms to ASTM 1476, Type 2, Class 3 specifications

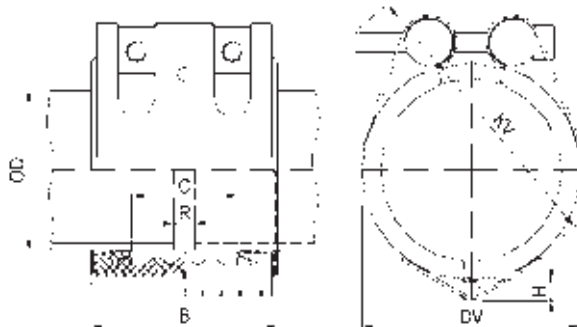

Size	Pipe OD Range		Working Pressure PSI	Coupling Dimensions			Assembled Dimensions		Maximum Distance Between Pipe End R	316 Ti Stainless Steel	
	actual	min to max		B	C	H	DV	KV		Part #	Price/E
1½"	1.90"	1.85" to 1.95"	363	3.0"	1.4"	.28"	2.8"	3.3"	.20"	STR35001	\$268.95
2"	2.38"	2.32" to 2.42"	232	3.0"	1.4"	.28"	3.2"	3.7"	.20"	STR35151	284.95
2½"	2.88"	2.81" to 2.93"	232	3.0"	1.4"	.36"	3.2"	3.7"	.20"	STR35201	310.00
3"	3.50"	3.44" to 3.56"	232	3.7"	2.0"	.36"	4.4"	4.9"	.20"	STR35351	324.95
4"	4.50"	4.43" to 4.57"	232	3.7"	2.0"	.36"	5.4"	5.9"	.20"	STR35651	343.65
5"	5.56"	5.49" to 5.57"	232	4.2"	2.4"	.38"	6.4"	7.1"	.20"	STR35901	433.80
6"	6.63"	6.54" to 6.71"	232	4.2"	2.4"	.38"	7.5"	8.1"	.20"	STR36051	464.80

⚠ Note: Not pull-out resistant. Ensure that pipes are properly anchored and supported.

Assembly Tool

Part #	Price/E
STR6648	\$348.55



150 Lb. ASA Forged Lap Joint Flanges

Features:

- no raised face
- The lap joint flange is commonly called a Van Stone or a floating flange.



Size	Number of Bolts	Carbon Steel		316 Stainless Steel	
		Part #	Price/E	Part #	Price/E
1"	4	LJ100	\$35.00	---	---
1¼"	4	LJ125	35.00	---	---
1½"	4	LJ150	26.00	LJR150	\$75.00
2"	4	LJ200	27.55	LJR200	125.00
2½"	4	LJ250	60.00	---	---
3"	4	LJ300	45.00	LJR300	190.00
4"	8	LJ400	62.00	LJR400	275.00
5"	8	LJ500	78.00	---	---
6"	8	LJ600	89.00	LJR600	430.00
8"	8	LJ800	158.00	---	---
10"	12	LJ1000	196.00	---	---
12"	12	LJ1200	325.00	---	---

150 Lb. ASA Forged Slip-On Flanges

Feature:

- raised face



Size	Number of Bolts	Carbon Steel		316 Stainless Steel	
		Part #	Price/E	Part #	Price/E
1"	4	SO100	\$22.05	---	---
1¼"	4	SO125	28.00	---	---
1½"	4	SO150	24.50	SOR150	\$78.00
2"	4	SO200	26.00	SOR200	102.00
2½"	4	SO250	41.00	---	---
3"	4	SO300	41.00	SOR300	170.00
4"	8	SO400	58.00	SOR400	225.00
5"	8	SO500	90.15	---	---
6"	8	SO600	79.00	SOR600	350.00
8"	8	SO800	133.00	---	---
10"	12	SO1000	182.00	---	---
12"	12	SO1200	288.00	---	---

150 Lb. ASA Forged NPT Threaded Flanges

Feature:

- raised face

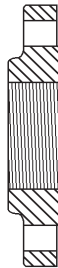

Size	Number of Bolts	Carbon Steel		316 Stainless Steel	
		Part #	Price/E	Part #	Price/E
1"	4	T100	\$44.00	---	---
1¼"	4	T125	43.00	---	---
1½"	4	T150	39.00	TR150	\$99.00
2"	4	T200	42.00	TR200	135.00
2½"	4	T250	49.00	---	---
3"	4	T300	50.00	TR300	195.00
4"	8	T400	67.00	TR400	276.80
5"	8	T500	87.10	---	---
6"	8	T600	107.00	TR600	661.50
8"	8	T800	182.00	---	---
10"	12	T1000	520.00	---	---
12"	12	T1200	670.00	---	---

- For flange dimensions, diagrams and additional information please reference dixonvalve.com.

150 Lb. Weld Neck ASA Forged Flanges

Feature:

- raised face

Size	Number of Bolts	Carbon Steel		
		Part #	Price/E	
1"	4	WN100	\$45.25	
1¼"	4	WN125	47.00	
1½"	4	WN150	47.25	
2"	4	WN200	53.00	
3"	4	WN300	62.75	
4"	8	WN400	74.50	
5"	8	WN500	115.00	
6"	8	WN600	113.00	
8"	8	WN800	198.00	
10"	12	WN1000	310.00	

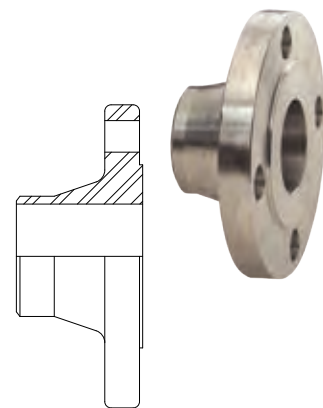

Pipe, Welding & Tube Fittings

Flange Gaskets

Features:

- standard drop-ring type all 1/16" thick
- reference page M-3 for joint sealant gasket material
- for dimensional information and diagrams please reference dixonvalve.com

Size	Carbon Steel		Klingersil® C-4401	
	Part #	Price/E	Part #	Price/E
1"	NG10	\$1.60	AG10	\$2.80
1¼"	NG15	1.95	AG15	3.10
1½"	NG20	1.95	AG20	3.20
2"	NG25	2.10	AG25	3.35
2½"	NG30	2.80	AG30	4.10
3"	NG35	2.30	AG35	5.30
4"	NG40	3.20	AG40	6.40
5"	NG50	6.70	---	---
6"	NG60	4.15	AG60	9.85
8"	NG80	6.80	AG80	13.75



carbon steel



Klingersil® C-4401

- For flange dimensions, diagrams and additional information please reference dixonvalve.com.

ANSI Flat Face Flange x Male NST (NH)

Features:

- flange - black powder coated carbon steel
- male adapter - black anodized aluminum

Size	PSI	Carbon Steel / Aluminum	
		Part #	Price/E
6" NST (NH)	175	T600-60F	\$278.70



King™ Turned Back Weld-To-Metal Hose Nipples

Features:

- MSS Length
- phono-finish face (type CS), except 10" and 12" have smooth face (type C)
- for use with Slip-On and Lap Joint flanges shown on page J-36

Size	Length	Schedule 40 Plated Carbon Steel		Schedule 40 304 Stainless Steel	
		Part #	Price/E	Part #	Price/E
1"	2"	NW10	\$27.05	RNW10-40	\$50.00
1¼"	2"	NW15	41.15	RNW15-40	105.00
1½"	2"	NW20	37.70	RNW20-40	53.00
2"	2½"	NW25	40.65	RNW25-40	55.00
2½"	2½"	NW30	54.00	RNW30-40	110.00
3"	2½"	NW35	58.65	RNW35-40	75.00
4"	3"	NW40	76.30	RNW40-40	112.00
6"	3½"	NW60	114.60	RNW60-40	210.00
8"	4"	NW80	146.65	RNW80-40	375.00
10"	5"	NW100	295.00	RNW100-40	925.00
12"	6"	NW120	465.00	RNW120-40	1425.00



Quick Release Couplings - Series Q

Features:

- designed for applications requiring a quick connection and/or disconnection of a pipe joint, a locking pin through the handle prevents accidental opening of the coupling
- ductile iron body with zinc plating and steel safety clip
- see page J-48 for replacement gaskets
- Comparable to: Victaulic's #78 Grinnell's #7003



Nominal Size	Pipe OD	Maximum Working Pressure PSI at 70°F (21°C)	Maximum End Load (Lbs.)	Ductile Iron		Price/E
				Part # with EPDM gasket	Part # with Buna-N gasket	
1½"	1.900"	300	850	H315	H315BU	\$135.00
2"	2.375"	300	1329	H32	H32BU	129.50
2½"	2.875"	300	2120	H325	H325BU	209.55
3"	3.500"	300	2886	H33	H33BU	166.50
4"	4.500"	300	4771	H34	H34BU	214.00
6"	6.625"	300	10341	H36	H36BU	460.00

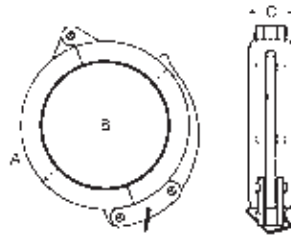

Dimensions

A	B	C
4¾"	3½"	1"
5½"	3¾"	1⅛"
5⅞"	4¾"	1⅛"
7¼"	5¼"	1⅛"
8½"	6½"	2"
10⅝"	8½"	2"

Standard Couplings - Series S, Style 11



Applications:

- designed for a wide range of applications including commercial/industrial construction, mining, and process piping

Features:

- ductile iron body with rust inhibiting paint
- Underwriters Listed and Factory Mutual approved
- housing design allows for optimum strength without excessive casting weight.
- see pages J-48, J-49 for replacement gaskets, nuts and bolts
- Comparable to:
Victaulic's #77
Grinnell's #7001



Nominal Size	Pipe OD	Maximum Working Pressure PSI at 70°F (21°C)	Maximum End Load (Lbs.)	Bolts			Ductile Iron		Price/E
				qty	size	length	Part # w/EPDM gasket	Part # w/Buna-N gasket	
1½"	1.900"	1000	2835	2	3/8"	2"	C115	C115BU	\$80.85
2"	2.375"	1000	4430	2	1/2"	2¾"	C12	C12BU	31.25
2½"	2.875"	1000	6492	2	1/2"	2¾"	C125	C125BU	33.30
3"	3.500"	1000	9621	2	1/2"	3"	C13	C13BU	40.55
4"	4.500"	1000	15904	2	5/8"	3¼"	C14	C14BU	67.40
6"	6.625"	1000	34472	2	3/4"	4¼"	C16	C16BU	97.40
8"	8.625"	800	46741	2	7/8"	5"	C18	C18BU	232.40
10"	10.750"	800	72610	2	7/8"	5"	C20	C20BU	240.75
12"	12.750"	800	102141	2	7/8"	5"	C24	C24BU	350.50

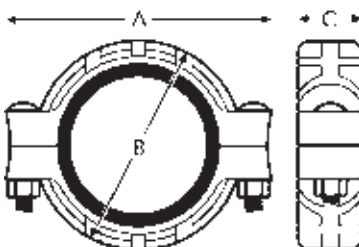

Dimensions

A	B	C
4-5/8"	3"	1-7/8"
5-15/64"	3-45/64"	1-27/32"
5-5/8"	4-1/4"	1-27/32"
6-21/32"	5"	1-27/32"
8-17/64"	6-3/8"	2-3/64"
11-7/32"	8-57/64"	2-3/64"
14-1/64"	11-3/8"	2-23/64"
16-5/8"	13-1/2"	2-5/8"
18-5/8"	15-1/2"	2-5/8"



Lightweight Flexible Couplings - Series L, Style 10

Pipe, Welding & Tube Fittings

Applications:

- designed for applications requiring moderate internal pressure or where weight is a factor such as general purpose, mining, irrigation, and compressed air where a deflection of 5% or less is required

Features:

- ductile iron body with rust inhibiting paint
- Underwriters Listed and Factory Mutual approved
- see pages J-48, J-49 for replacement gaskets, nuts and bolts
- Comparable to: Victaulic's #75 Grinnell's #7000



Nominal Size	Pipe OD	Maximum Working Pressure PSI at 70°F (21°C)	Maximum End Load (Lbs.)	Bolts			Ductile Iron		Price/E
				qty	size	lgth	Part # w/EPDM gasket	Part # w/Buna-N gasket	
1½"	1.900"	500	1418	2	⅜"	2¼"	L215	L215BU	\$64.50
2"	2.375"	500	2215	2	⅜"	2"	L02	L02BU	17.65
2½"	2.875"	300	3246	2	⅜"	2"	L025	L025BU	20.20
3"	3.500"	300	4811	2	½"	2¾"	L03	L03BU	23.75
4"	4.500"	300	6362	2	½"	2¾"	L04	L04BU	31.20
5"	5.563"	300	9722	2	⅝"	3¼"	L05	L05BU	63.65
6"	6.625"	300	13789	2	⅝"	3¼"	L06	L06BU	52.05
8"	8.625"	300	20449	2	¾"	4¼"	L08	L08BU	88.50
10"	10.750"	350	29815	2	¾"	4¼"	L010	L010BU	132.00
12"	12.750"	350	40581	2	⅞"	5"	L012	L012BU	184.00

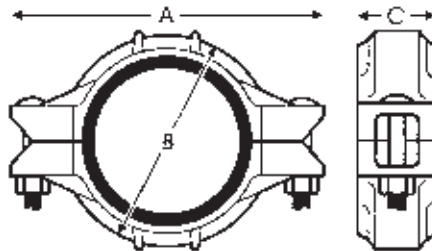

Dimensions

A	B	C
4-5/8"	3"	1-3/4"
5-7/64"	3-1/2"	1-27/32"
5-55/64"	4-1/64"	1-27/32"
6-13/32"	4-13/16"	1-27/32"
7-33/64"	5-55/64"	2"
9-5/8"	7"	2"
10-25/32"	7-7/8"	2-3/64"
13-47/64"	10-35/64"	2-13/32"
16-19/64"	13-15/64"	2-9/16"
18-23/64"	15-7/16"	2-9/16"

Lite® Couplings - Stainless Steel



Applications:

- designed for use on rigid, locked-in pipe connections

Features:

- 316 cast stainless steel body, nuts and bolts
- certified to ANSI/NSF 61
- ideal for corrosive environments
- use of suitable anti-galling thread compound is recommended
- Comparable to: Grinnell's #7400 SS



Nominal Size	Pipe OD	Maximum Working Pressure (PSI)	Maximum End Load (Lbs.)	Bolts			316 Stainless Steel	
				qty	size	length	Part # w/ Fluoro-elastomer gasket	Price/E
2"	2.375"	300	1329	2	3/8"	2 1/4"	RL02V	\$1140.00
3"	3.500"	300	2886	2	1/2"	2 3/4"	RL03V	1430.00
4"	4.500"	300	4771	2	1/2"	2 3/4"	RL04V	2120.00

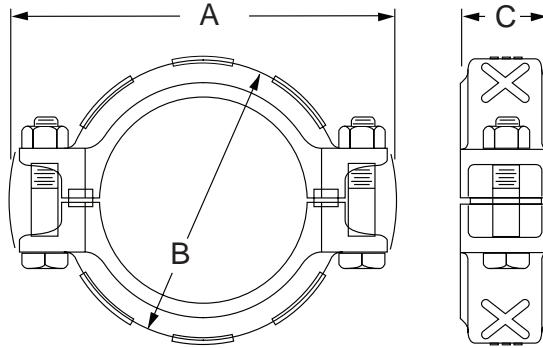

Dimensions

A	B	C
5 5/8"	3 5/8"	1 3/4"
6 5/8"	4 5/8"	1 3/4"
7 3/4"	6"	1 7/8"





Rigid Couplings - Series R, Style 5

Pipe, Welding & Tube Fittings

Application:

- ideal for fire protection, plumbing, low pressure air and drainage

Features:

- lightweight, low pressure
- galvanized ductile iron body
- small gripping teeth hold the housing into the groove allowing a straight run of pipe and preventing any flex at the joint
- Underwriters Listed and Factory Mutual approved
- see pages J-48, J-49 for replacement gaskets, nuts and bolts



Nominal Size	Pipe OD	Maximum Working Pressure PSI at 70°F (21°C)	Maximum End Load (Lbs.)	Bolts			Ductile Iron		Price/E
				qty	size	length	Part # w/EPDM gasket	Part # w/Buna-N gasket	
2"	2.375"	175	4425	2	3/8"	2"	R72	R72BU	\$21.25
2½"	2.875"	175	6490	2	3/8"	2"	R725	R725BU	18.30
3"	3.500"	175	9620	2	½"	2¾"	R73	R73BU	25.75
4"	4.500"	175	12720	2	½"	2¾"	R74	R74BU	32.45
6"	6.625"	175	27570	2	5/8"	3¼"	R76	R76BU	54.95
8"	8.625"	175	35050	2	¾"	4¼"	R78	R78BU	88.50

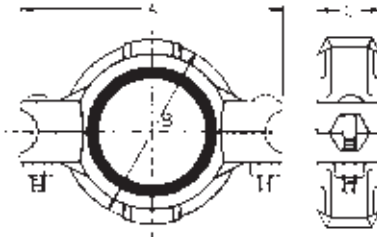

Dimensions

A	B	C
4-7/8"	3-17/32"	1-27/32"
5-5/8"	3-45/64"	1-3/4"
6-3/8"	4-41/64"	1-27/32"
7-45/64"	5-15/16"	2"
10-25/32"	8-7/64"	2-3/64"
13-25/32"	10"	2-21/64"

Grooved Bolted Clamps

Features:

- 2" pressure rating: **400 PSI**
- 3" pressure rating: **170 PSI**
- 4" pressure rating: **120 PSI**
- bolt torque: 20 ft. lbs.
- precision casting and machined dimensions provide an exact fit and great appearance
- use of lock nuts prevents clamps from loosening in high vibration applications
- leak-tight connection
- are intended for tank truck applications only 
- Unlike steel groove clamps that secure pipe ends with high clamp force against the tubing walls, the Dixon® bolted clamp takes the full bolt force and locks in the groove of the tube preventing distortion of the tube diameter.
- FKM-B rated for 100% biodiesel and Ethanol
- Buna-N rated for petroleum service, Ethanol to E100 and biodiesel to B20
- Baylast™ rated for petroleum service, Ethanol to E100 and biodiesel to B100
- white buna-N for use in dry bulk food applications
- temperature ratings for FKM-B is **20°F to 300°F (-7°C to 149°C)**
- temperature ratings for Baylast is **-20°F to 180°F (-29°C to 82°C)**



clamp with black buna gasket
 Note: Supplied clamp gasket must be installed prior to use, ships separately.

Size	Gasket Material	Aluminum	
		Part #	Price/E
2"	FKM-B	DBV-VB200	\$79.85
3"	FKM-B	DBV-VB300	90.20
4"	FKM-B	DBV-VB400	148.55
3"	buna-N	DBV-BN300	37.15
4"	buna-N	DBV-BN400	47.75
2"	Baylast™	DBV-BL200	51.50
3"	Baylast™	DBV-BL300	61.15
4"	Baylast™	DBV-BL400	77.25
4"	white buna-N	DBV-WB400	58.35

Replacement Gaskets

Size	Material	Part #	Price/E
2"	FKM-B	G200VB	\$61.05
3"	FKM-B	G300VB	58.35
4"	FKM-B	G400VB	116.70
3"	buna-N	G300T	12.30
4"	buna-N	G400T	17.90
2"	Baylast™	G200BL	29.00
3"	Baylast™	G300BL	34.95
4"	Baylast™	G400BL	41.45
4"	white buna-N	G400N	36.50



Painted Iron Clamps with Baylast™ Gaskets

Features:

- painted red
- Baylast™ seal is rated for biodiesel, Ethanol, diesel, gas and ULSD

Size	Maximum PSI	Iron	
		Part #	Price/E
2"	500	L02BL	\$85.95
3"	300	L03BL	102.00
4"	300	L04BL	128.85



NEW



Mechanical Tees - Series T

Features:

- Provides a fast easy way to install a threaded connection along a length of pipe. After drilling or cutting a hole in the pipe at the location of the branch connection, simply attach the clamps around the pipe for a leak-free threaded outlet connection. See chart below for drilling hole specifications
- ductile iron body with rust inhibiting paint
- Underwriters Listed and Factory Mutual approved
- maximum operating pressure: **300 PSI at 70°F (21°C)**
- see pages J-48, J-49 for replacement gaskets, nuts and bolts
- Comparable to:
Victaulic's #920
Grinnell's #7045



Nominal Size	Branch Size	Hole Saw Diameter	Maximum End Load (Lbs.)	qty	Bolts		Ductile Iron	
					size	length	Part #	Price/E
2"	1"	1 1/2"	1 5/8"	2	3/8"	2"	MT2010	\$37.45
2"	1 1/4"	1 3/4"	1 7/8"	2	3/8"	2"	MT20125	41.20
2"	1 1/2"	1 3/4"	1 7/8"	2	3/8"	2"	MT20150	41.20
2 1/2"	1"	1 1/2"	1 5/8"	2	1/2"	2 5/8"	MT25010	47.45
2 1/2"	1 1/4"	2"	2 1/8"	2	1/2"	2 5/8"	MT250125	51.20
3"	1"	1 1/2"	1 5/8"	2	1/2"	2 3/4"	MT3010	56.20
3"	1 1/2"	2"	2 1/8"	2	1/2"	2 3/4"	MT30150	51.20
4"	1"	1 1/2"	1 5/8"	2	1/2"	2 3/4"	MT4010	71.45
4"	1 1/4"	2"	2 1/8"	2	1/2"	2 3/4"	MT40125	58.65
4"	1 1/2"	2"	2 1/8"	2	1/2"	2 3/4"	MT40150	61.15
4"	2"	2 1/2"	2 5/8"	2	1/2"	2 3/4"	MT4020	61.15
4"	2 1/2"	2 3/4"	2 7/8"	2	1/2"	2 3/4"	MT40250	63.65
4"	3"	3 1/2"	3 5/8"	2	1/2"	2 3/4"	MT4030	68.05
6"	1 1/4"	2 1/2"	2 5/8"	2	5/8"	3 1/4"	MT60125	76.75
6"	1 1/2"	2 1/2"	2 5/8"	2	5/8"	3 1/4"	MT60150	76.75
6"	2"	2 1/2"	2 5/8"	2	5/8"	3 1/4"	MT6020	76.75
6"	3"	3 1/2"	3 5/8"	2	5/8"	3 1/4"	MT6030	88.65

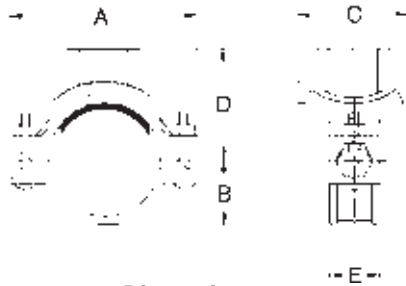

Dimensions

A	B	C	D	E
4 1/2"	1 3/8"	2 3/4"	2 1/4"	1 7/8"
4 1/2"	1 3/8"	2 3/4"	2 1/2"	1 7/8"
4 1/2"	1 3/8"	2 3/4"	2 1/2"	1 7/8"
5-5/32"	1-11/16"	3"	2-31/32"	2"
5-13/16"	1-11/16"	3-11/32"	3"	2"
6-11/32"	2-1/8"	3-3/32"	3-1/16"	2"
6-11/32"	2-1/8"	3-3/4"	3-3/8"	2"
7-5/16"	2-9/16"	3-3/32"	3-1/2"	2"
7-5/16"	2-9/16"	3-3/4"	3-7/8"	2"
7-5/16"	2-9/16"	3-3/4"	3-7/8"	2"
7-5/16"	2-9/16"	4-1/8"	4"	2"
7-5/16"	2-9/16"	4-3/8"	4"	2"
7-5/16"	2-9/16"	5-1/4"	4-1/4"	2"
10-5/32"	3-11/16"	4-1/8"	4-7/8"	2 1/4"
10-5/32"	3-11/16"	4-1/8"	4-7/8"	2 1/4"
10-5/32"	3-11/16"	4-1/8"	5"	2 1/4"
10-5/32"	3-11/16"	5-1/4"	5-3/8"	2 1/4"

Flange Adapters - Series FA

Application:

- used to connect an ANSI Class 125 and 150 flange to a grooved pipe using a grooved clamp

Features:

- Provides a rigid one piece connection that can be disconnected by removing the clamp assembly. To assemble to another flange, position bolt heads on the adapter (grooved) side.
- ductile iron body with rust inhibiting paint

Nominal Size	Pipe OD	Maximum Working Pressure PSI at 70°F (21°C)	Flange Dimensions		Bolts		Ductile Iron	
			A	B	qty	size	Part #	Price/E
2"	2.375"	300	6"	2-3/8"	4	5/8"	FA20	\$37.40
3"	3.500"	300	7 1/4"	2-3/8"	4	5/8"	FA30	61.15
4"	4.500"	300	8 1/2"	2-3/8"	8	5/8"	FA40	77.40
6"	6.625"	300	11"	2-9/16"	8	3/4"	FA60	142.30
8"	8.625"	300	13 1/4"	3"	8	3/4"	FA80	208.50

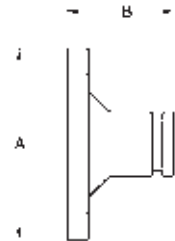

Pipe, Welding & Tube Fittings

ANSI Split Flanges - Series SF



Features:

- provides a direct connection between a grooved adapter and an ANSI Class 125 and 150 raised face flanged component
 - can be used with flat face flanges by removing the raised projections on the outside face of the flange.
 - ductile iron body with rust inhibiting paint
 - Underwriters Listed and Factory Mutual approved
 - Buna gaskets are available upon request
- Comparable to: Victaulic's #741, Grinnell's #7012

Nom. Size	Pipe OD	Max. Work. Press. PSI at 70°F (21°C)	Flange Dims.		Bolts		Ductile Iron w/ Gasket		Replacement EPDM Gaskets	
			A	B	qty	size	Part # ¹	Price/E	Part # ²	Price/E
2"	2.375"	300	6"	13/16"	4	5/8"	ANSI20	\$75.85	FLG200E	\$8.15
2 1/2"	2.875"	300	7"	13/16"	4	5/8"	ANSI25	82.05	FLG250E	9.40
3"	3.500"	300	7 1/2"	13/16"	4	5/8"	ANSI30	98.60	FLG300E	10.95
4"	4.500"	300	9"	15/16"	8	5/8"	ANSI40	131.05	FLG400E	12.50
6"	6.625"	300	11"	1"	8	3/4"	ANSI60	156.00	FLG600E	19.35
8"	8.625"	300	13 1/2"	1-1/8"	8	3/4"	ANSI80	199.70	FLG800E	34.00

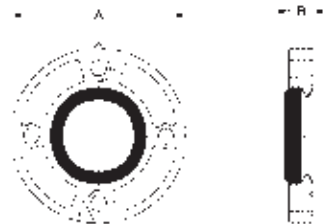

¹ with EPDM gasket
² replacement gasket

Reducing Adapters - Series RA



Features:

- ductile iron body with rust inhibiting paint
- Underwriters Listed and Factory Mutual approved
- Comparable to: Victaulic's #50, Grinnell's #7072

Nominal Size	Nominal Size	Dimensions E to E	Ductile Iron	
			Part #	Price/E
2"	1 1/2"	2.5"	RAGG20150	\$26.25
2 1/2"	2"	2.5"	RAGG25020	27.45
3"	2"	2.5"	RAGG3020	26.25
3"	2 1/2"	2.5"	RAGG30250	32.45
4"	2"	3.0"	RAGG4020	38.60
4"	2 1/2"	3.0"	RAGG40250	40.55
4"	3"	3.0"	RAGG4030	43.25
5"	4"	3.5"	RAGG5040	69.90
6"	2"	4.0"	RAGG6020	82.00
6"	2 1/2"	4.0"	RAGG60250	90.30
6"	3"	4.0"	RAGG6030	82.40
6"	4"	4.0"	RAGG6040	82.40

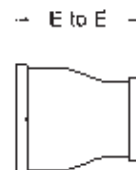



Grooved End Fittings - Series 45

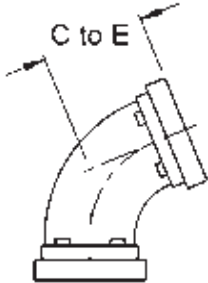

Features:

- designed to provide minimum pressure drop and uniform strength
- maximum operating pressure: **500 PSI** at ambient temperature **70°F (21°C)**
- ductile iron body with rust inhibiting paint
- Underwriters Listed and Factory Mutual approved
- Comparable to:
Victaulic's #110
Grinnell's #7051

Nominal Size	Dimensions C to E	Ductile Iron	
		Part #	Price/E
2"	2"	L2045	\$22.15
2½"	2¼"	L2545	23.05
3"	2½"	L3045	34.95
4"	3"	L4045	51.15
5"	3¼"	L5145	113.50
6"	3½"	L6045	129.50
8"	4¼"	L8045	258.90



Grooved End Fittings - Series 90

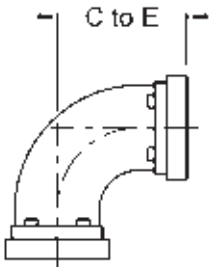

Features:

- designed to provide minimum pressure drop and uniform strength
- maximum operating pressure: **500 PSI** at ambient temperature **70°F (21°C)**
- ductile iron body with rust inhibiting paint
- Underwriters Listed and Factory Mutual approved
- Comparable to:
Victaulic's #10
Grinnell's #7050

Nominal Size	Dimensions C to E	Ductile Iron	
		Part #	Price/E
2"	3¼"	L502	\$22.50
2½"	3¾"	L5025	25.85
3"	4¼"	L503	41.20
4"	5"	L504	54.15
6"	6½"	L506	129.50
8"	7¾"	L508	287.05



Grooved End Fittings - Series T

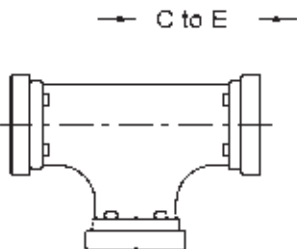

Features:

- designed to provide minimum pressure drop and uniform strength
- maximum operating pressure: **500 PSI** at ambient temperature **70°F (21°C)**
- ductile iron body with rust inhibiting paint
- Underwriters Listed and Factory Mutual approved
- Comparable to:
Victaulic's #20
Grinnell's #7060

Nominal Size	Dimensions C to E	Ductile Iron	
		Part #	Price/E
2"	3¼"	T602	\$32.45
2½"	3¾"	T6025	39.95
3"	4¼"	T603	54.95
4"	5"	T604	81.30
6"	6½"	T606	196.75
8"	7¾"	T608	425.25

ANSI Caps with Tapped Outlet - Series EC

Feature:

- ductile iron construction with rust inhibiting paint

Nominal Size	Outlet	Dimensions E to E	Ductile Iron	
			Part #	Price/E
2"	1"	7/8"	EC201	\$31.30
2½"	1"	7/8"	EC251	40.50
3"	1"	7/8"	EC301	40.30
4"	1"	1"	EC401	43.85
4"	2"	1"	EC402	39.85
6"	1"	1"	EC601	99.05
6"	2"	1"	EC602	105.20
8"	2"	1-3/16"	EC802	202.15



Pipe, Welding
& Tube Fittings

Blank Caps - Series BE



Features:

- ductile iron body with rust inhibiting paint
- Underwriters Listed and Factory Mutual approved
- Comparable to:
Victaulic's #60
Grinnell's #7074

Nominal Size	Dimensions E to E	Ductile Iron	
		Part #	Price/E
2"	7/8"	BEC20	\$27.45
2½"	7/8"	BEC25	36.20
3"	7/8"	BEC30	37.45
4"	1"	BEC40	38.70
6"	1"	BEC60	96.75
8"	1-3/16"	BEC80	178.50



Long Pipe Style Nipples - Series AN

Groove x NPT	Dimensions E to E	Carbon Steel	
		Part #	Price/E
2"	4"	A712	\$48.65
2½"	4"	A7125	57.05
3"	4"	A713	88.60
4"	6"	A714	115.80
5"	6"	A715	185.00
6"	6"	A716	205.00

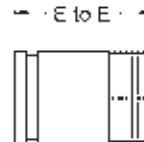

Grooved End x Weld Nipples

Nominal Size	Aluminum		Carbon Steel		316 Stainless Steel	
	Part #	Price/E	Part #	Price/E	Part #	Price/E
2"	AVN2000-200	\$18.50	VN2000-200	\$19.15	VNR2000-200	\$29.15
2½"	AVN2500-200	33.40	VN2500-200	21.70	VNR2500-200	30.40
3"	AVN3000-200	26.30	VN3000-200	24.25	VNR3000-200	38.75
4"	AVN4000-200	42.30	VN4000-200	37.10	VNR4000-200	53.70



- For additional information on pipe dimensions please reference dixonvalve.com.

Grooved End Butterfly Valves

Features:

- for water and air applications
- working pressure: **300 PSI**
- maximum temperature: **210°F (99°C)**
- material: **body:** ductile iron, epoxy coated; **disc:** ductile iron, EPDM encapsulated; **stem:** stainless steel; **notch plate:** zinc plated steel; **seals:** EPDM

Size	Ductile Iron	
	Part #	Price/E
2"	GIBFV200	\$232.00
2½"	GIBFV250	266.00
3"	GIBFV300	367.00
4"	GIBFV400	476.00
6"	GIBFV600	810.00
8"	GIBFV800	1010.00



GROOVED COUPLING



GASKET PIPE or FITTING

Grooved Fitting Gaskets

- check gasket color code to be certain it is recommended for the service intended
- use lubricant on gasket (reference next page)
- for services not listed contact Dixon® for recommendations



FKM Gaskets

Features:

- temperature range: **-13°F to 350°F (-11°C to 177°C)**
- color code: black with blue stripe
- resistant to oxidizing acids, petroleum oils, hydraulic fluids, halogenated hydrocarbons and lubricants

Size	FKM	
	Part #	Price/E
2"	G200V	\$38.35
3"	G300V	57.05
4"	G400V	79.45
6"	G600V	113.00
8"	G800V	188.50
10"	G1000V	233.95
12"	G1200V	295.55

EPDM Gaskets

Features:

- temperature range: **-22°F to 230°F (-30°C to 110°C)**
- color code: black with green stripe
- for water, dilute acids, alkalis, salts, and many chemical services not involving hydrocarbons, oils, or gases.
- excellent oxidation resistance
- *Not for use with hydrocarbons*



Size	EPDM	
	Part #	Price/E
1½"	G150E	\$34.60
2"	G200E	9.25
2½"	G250E	11.10
3"	G300E	12.30
4"	G400E	17.90
5"	G500E	25.10
6"	G600E	32.30
8"	G800E	52.60
10"	G1000E	67.00
12"	G1200E	92.00

Buna Gaskets

Features:

- temperature range: **-24°F to 176°F (-31°C to 80°F)**
- for petroleum products, vegetable oils, mineral oils, and air contaminated with petroleum oils.
- *not for use in hot water services*



Size	Black Buna with orange stripe		White Buna	
	Part #	Price/E	Part #	Price/E
1½"	G150T	\$34.60	---	---
2"	G200T	9.25	---	---
2½"	G250T	11.10	---	---
3"	G300T	12.30	---	---
4"	G400T	17.90	G400N	\$36.50
5"	G500T	25.10	---	---
6"	G600T	32.30	---	---
8"	G800T	52.60	---	---
10"	G1000T	67.00	---	---
12"	G1200T	92.00	---	---



Grooved Fitting Accessories

Nuts and Bolts

Features:

- the nuts are a heavy hexagon design
- specifically designed for use with the couplings on pages J-39 to J-44

Specification:

- conforms to ASTM A183

Bolt Thread	Bolt Length	Torque Ft. Lbs.	Electroplated Carbon Steel	
			Part #	Price/E
3/8"	2"	30	BLT38200	\$5.95
3/8"	2 1/4"	30	BLT38225	19.30
1/2"	2 1/2"	50	BLT50212	5.95
1/2"	2 3/4"	50	BLT50234	8.15
1/2"	3"	50	BLT50300	9.80
5/8"	3 1/4"	75	BLT58314	5.35
3/4"	4 1/4"	75	BLT75414	17.50
7/8"	5"	200	BLT78500	18.50



Groove Lube

Features:

- water soluble
- non-toxic
- non-corrosive
- non-flammable
- *should not be used with HDPE pipe*



Specification:

- NSF approved for use with potable water

Size	Container	Part #	Price/E
1 qt.	Tub	GROOVLUB32	\$263.00



High Density Polyethylene (HDPE) Couplings

Applications:

- designed for mechanically joining high density polyethylene pipe and fittings

Features:

- ductile iron body with rust inhibiting paint
- uses four bolts to drive the sharply machined housing teeth into the outside of the pipe
- Comparable to: Grinnell's #9095

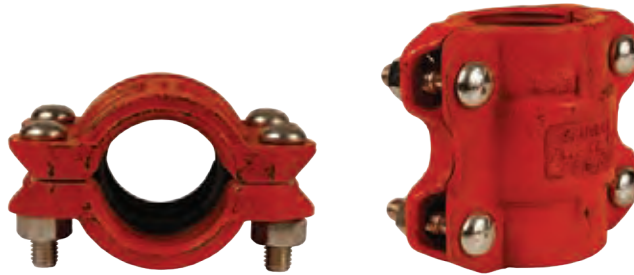

Nominal Size	Pipe OD	qty	Bolts		Part # w/EPDM gasket	Ductile Iron		Price/E
			size	length		Part # w/Buna-N gasket		
2"	2.375"	4	1/2"	2 3/8"	HDPE200	HDPE200BU	\$510.00	
3"	3.500"	4	1/2"	3"	HDPE300	HDPE300BU	610.00	
4"	4.500"	4	1/2"	3"	HDPE400	HDPE400BU	670.00	
6"	6.625"	4	5/8"	3 1/2"	HDPE600	HDPE600BU	930.00	

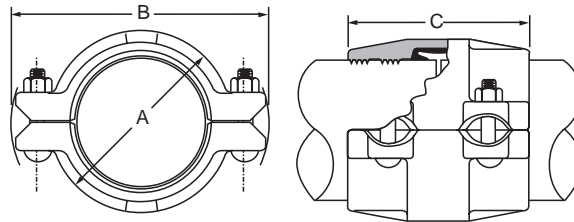

Dimensions

A	B	C
3 3/8"	5 1/2"	4 5/8"
4 5/8"	6 3/4"	4 5/8"
5 1/4"	8"	5 3/4"
7 1/2"	11"	5 7/8"



Y Line Strainers

Cast Iron

Features:

- graphite gasket
- working pressure: **400 PSI WOG, 250 PSI steam**
- plug ported for blowdown service
- no replacement screens available

Female NPT	Description	Cast Iron	
		Part #	Price/E
1/4"	20 x 20 mesh	Y001	\$30.00
3/8"		Y002	30.00
1/2"		Y003	36.00
3/4"		Y004	44.00
1"		Y005	55.00
1 1/4"		Y006	78.00
1 1/2"		Y007	96.00
2"		Y008	144.00



Cast Bronze

Feature:

- working pressure: **400 PSI WOG, 125 PSI steam**

Female NPT	Description	Cast Bronze		304 Stainless Replacement Screens	
		Part #	Price/E	Part #	Price/E
1/4"	50 x 50 mesh	59-001	\$52.00	G3271-00	\$6.50
3/8"	50 x 50 mesh	59-002	52.00	G2457-00	6.85
1/2"	50 x 50 mesh	59-003	52.00	G2457-00	6.85
3/4"	20 x 20 mesh	59-004	99.00	G3224-00	6.25
1"	20 x 20 mesh	59-005	131.00	G3225-00	13.70
1 1/4"	20 x 20 mesh	59-006	235.00	G3231-00	19.25
1 1/2"	20 x 20 mesh	59-007	261.00	G3229-00	20.75
2"	20 x 20 mesh	59-008	427.00	G3230-00	16.00



replacement screen

Polypropylene

Features:

- protects and prevents clogging of pipelines, pumps and spray tips
- glass-filled polypropylene body
- easy access for cleaning
- maximum operating pressure: **90 PSI at 70°F (21°C)**

Female NPT	Description	Polypropylene		304 Stainless Replacement Screens	
		Part #	Price/E	Part #	Price/E
3/4"	40 mesh	PYLS7540	\$35.50	61450	\$17.10
1"	40 mesh	PYLS10040	44.25	61746	18.50
1 1/2"	40/20 mesh	PYLS15040	97.00	61509	43.00
2"	40/20 mesh	PYLS20040	97.00	61509	43.00



replacement screen

Polypropylene T Line Strainers

Features:

- white polypropylene allows easy inspection
- maximum operating pressure: **100 PSI at 70°F (21°C)**

Female NPT	Description	Polypropylene		304 Stainless Replacement Screens	
		Part #	Price/E	Part #	Price/E
3/4"	40 mesh	PTLS7540	\$26.25	61405	\$12.00
1"	40 mesh	PTLS10040	26.25	61405	12.00



LP Gas Couplings and Adapters

Pipe, Welding & Tube Fittings

Specifications:

- products meet or exceed the requirements of Compressed Gas Association (CGA), the National Fire Protection Association (NFPA), the Canadian Gas Association, American Society of Mechanical Engineers (ASME) and Underwriters Laboratories (UL)

Male Acme x Male NPT Adapters

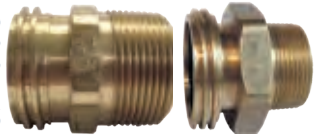

ME217 ME233



ME502-12/8 ME503-16

Male Acme	Male NPT	Female NPT	Part #	Brass	Price/E
1 3/4"	1 1/4"	--	ME217		\$38.60
2 1/4"	1 1/4"	--	ME233		148.05
2 1/4"	1 1/2"	1"	ME502-12/8 ¹		228.90
3 1/4"	2"	--	ME503-16		184.80

¹ dual threads - male outside / female inside

Male Acme x Female NPT Adapters



Male Acme	Female NPT	Part #	Brass	Price/E
1 3/4"	1"	ME214		\$38.60
3 1/4"	2"	ME252-16		169.05

Male Acme x Male NPT Adapters



ME217S ME503S-16

Male Acme	Male NPT	Part #	Steel	Price/E
1 3/4"	1 1/4"	ME217S		\$92.95
2 1/4"	1 1/4"	ME233S		181.65
3 1/4"	2"	ME503S-16		385.35

Male Acme x Female NPT Adapter



Male Acme	Female NPT	Part #	Steel	Price/E
3 1/4"	2"	ME252S-16		\$263.55

Female Acme x Male Acme Adapters



brass steel

Female Acme	Male Acme	Material	Part #	Price/E
3 1/4"	1 3/4"	brass	ME612	\$281.40
3 1/4"	1 3/4"	steel	ME612S	414.75

LP Gas Couplings and Adapters

Female Acme x MNPT Filler Couplings, Brass Nut

Female Acme	Male NPT	Material	Part #	Price/E
1 3/4"	1"	brass nut, brass nipple	ME112	\$48.85
2 1/4"	1 1/4"	brass nut, brass nipple	ME120	222.60
2 1/4"	1 1/4"	brass nut, steel nipple	ME120S	262.50
3 1/4"	2"	brass nut, steel nipple	ME130	324.45



Pipe, Welding & Tube Fittings

Female Acme x MNPT Filler Couplings, Steel Nut

Female Acme	Male NPT	Steel	
		Part #	Price/E
1 3/4"	1"	ME112S	\$107.65
2 1/4"	1 1/4"	ME121S	232.05
3 1/4"	2"	ME130S	266.70



Acme Gaskets

Size	Nitrile	
	Part #	Price/E
1 3/4"	MEW2	\$0.75
2 1/4"	MEW5	3.70
3 1/4"	MEW6	3.85



Clamp Style Hose Couplings

Features:

- clamp sections and hose barbs are made of steel and ductile iron
- 32B and 32S sizes offer a female Acme swivel to eliminate the need to add additional weight and bulk to the hose assembly

Hose Barb	Thread Size	Material	Part #	Price/E
1"	1" male NPT	steel nipple, 2-piece ductile iron clamp	ME3162-16	\$100.80
1 1/4"	1 1/4" male NPT	steel nipple, 2-piece ductile iron clamp	ME3162-20	161.70
1 1/2"	1 1/2" male NPT	steel nipple, 2-piece ductile iron clamp	ME3162-24	211.05
2"	2" male NPT	steel nipple, 2-piece ductile iron clamp	ME3162-32	241.50
2"	3 1/4" female Acme	steel nipple, brass nut, 2-piece ductile iron clamp	ME3162-32B	478.80
2"	3 1/4" female Acme	steel nipple, steel nut, 2-piece ductile iron clamp	ME3162-32S	473.55



Acme Spanner Wrench

Feature:

- used on 1 3/4", 2 1/4", 3 1/4" and 4 1/4" fittings

Aluminum	
Part #	Price/E
MEP120B	\$117.60



LP Gas Hose Caps and Plugs

Metal Caps



ME229



ME441F

Female Acme Threads	Description	Material	Part #	Price/E
1 3/4"	cap with ring and chain	brass	ME229-1	\$75.10
1 3/4"	cap with ring and chain	steel	ME229S-1	128.10
2 1/4"	cap with knob plug and chain	brass	ME431F-1	189.00
2 1/4"	cap with knob plug, ring, chain	steel	ME431FS-1	214.20
3 1/4"	cap with knob plug, ring and chain	brass	ME441F-1	286.65
3 1/4"	cap with knob plug, ring and chain	steel	ME441FS-1	312.90

Plastic Caps



ME109-1



ME109-NH3-1

Female Acme Threads	Description	Plastic	
		Part #	Price/E
1 3/4"	cap with ring and chain, yellow	ME109-1	\$9.00
1 3/4"	cap with chain assembly, for anhydrous service	ME109-NH3-1	10.20

Plastic Dust Plugs



ME179-1



ME180-1



ME181-1

Male Acme Threads	Description	Plastic	
		Part #	Price/E
1 3/4"	plug with dust seal and chain assembly, yellow	ME179-1	\$34.15
2 1/4"	plug with dust seal and chain assembly, yellow	ME180-1	41.50
3 1/4"	plug with dust seal and chain assembly, yellow	ME181-1	90.30

Instrumentation Fittings

Applications:

- high pressure
- high temperature
- nitrogen
- helium
- flammable gases
- hydraulic gases
- corrosive media
- pneumatic automation

Features:

- Instrumentation fittings come completely assembled.
- fully interchangeable with Swagelok® and Parker A-Lok®, all fittings are ASTM F 1387 Certified
- double collet (ferrule) swaging action
- two positive seal points
- ASTM 316 stainless steel material construction
- temperature range: **-325°F to 1200°F (-198°C to 648°C)**
- pressure ratings: see chart to the left, ratings listed are for reference only

Installation Instructions:

1. Cut tubing squarely and clean tube end thoroughly to remove burrs.
2. Insert the tubing into the assembly making sure the tubing seats firm against the shoulder of the body and the nut is finger tight.
3. Tighten the nut with a wrench 1¼ turns, while holding the body with a second wrench.

Suggested Working Pressures (PSI)

Wall thk.	.028	.035	.049	.065	.083	.095	.109
¼"	4,000	5,100	7,500	10,100	---	---	---
⅜"	---	3,300	4,700	6,600	---	---	---
½"	---	2,600	3,700	5,000	6,600	---	---
⅝"	---	---	2,900	3,900	5,200	6,000	---
¾"	---	---	2,400	3,200	4,200	4,900	5,700

Safety Guidelines:

- Never connect, disconnect or remake a fitting with pressure in the system.
- Make sure all fittings are properly installed.
- It is not recommended to go beyond the pressure rating of the tubing. Elongation could occur in the tubing, shrinking the wall thickness and causing potential harm.
- For proper sealing it is recommended that the tubing and fittings be of like material.
- Always use proper thread lubricant and sealants on tapered pipe threads.
- Never bleed a system by loosening a fitting.

Male Connectors

Tube OD	Male NPT	Interchanges	316 Stainless Steel		Pkg Qty
			Part #	Price/E	
⅛"	⅛"-27	200-1-2	2-DMC-2	\$15.90	10
	¼"-18	200-1-4	2-DMC-4	16.80	10
¼"	⅛"-27	400-1-2	4-DMC-2	15.20	10
	¼"-18	400-1-4	4-DMC-4	16.55	10
	⅜"-18	400-1-6	4-DMC-6	18.65	10
	½"-14	400-1-8	4-DMC-8	24.75	10
⅜"	¼"-18	600-1-4	6-DMC-4	19.50	10
	⅜"-18	600-1-6	6-DMC-6	22.05	10
	½"-14	600-1-8	6-DMC-8	26.55	10
½"	¼"-18	810-1-4	8-DMC-4	28.90	10
	⅜"-18	810-1-6	8-DMC-6	29.70	10
	½"-14	810-1-8	8-DMC-8	33.10	10
⅝"	½"-14	1010-1-8	10-DMC-8	44.85	10
	½"-14	1210-1-8	12-DMC-8	60.40	10
¾"	¾"	1210-1-12	12-DMC-12	60.40	10
	1"	1210-1-16	12-DMC-16	83.00	10
	¾"	1610-1-12	16-DMC-12	105.00	10
1"	1"	1610-1-16	16-DMC-16	138.00	10



Female Connectors

Tube OD	Female NPT	Interchanges	316 Stainless Steel		Pkg Qty
			Part #	Price/E	
⅛"	⅛"-27	200-7-2	2-DFC-2	\$18.90	10
¼"	⅛"-27	400-7-2	4-DFC-2	18.70	10
	¼"-18	400-7-4	4-DFC-4	23.10	10
⅜"	¼"-18	600-7-4	6-DFC-4	23.95	10
	½"-14	600-7-8	6-DFC-8	41.50	10
½"	½"-14	810-7-8	8-DFC-8	46.25	10
⅝"	½"	1010-7-8	10-DFC-8	54.00	10
¾"	½"	1210-7-8	12-DFC-8	62.00	10
	¾"	1210-7-12	12-DFC-12	73.00	10
1"	1"	1610-7-16	16-DFC-16	134.00	10



Instrumentation Fittings

Pipe, Welding & Tube Fittings



Unions

Tube OD	Interchanges	316 Stainless Steel		Pkg Qty
		Part #	Price/E	
1/8" x 1/8"	200-6	2-DU	\$22.75	10
1/4" x 1/8"	400-6-2	4-DU-2	24.00	10
1/4" x 1/4"	400-6	4-DU	23.85	10
3/8" x 1/4"	600-6-4	6-DU-4	33.10	10
3/8" x 3/8"	600-6	6-DU	33.10	10
1/2" x 1/2"	810-6	8-DU	50.00	10
5/8" x 5/8"	1010-6	10-DU	72.00	10
3/4" x 3/4"	1210-6	12-DU	97.00	10
1" x 1"	1610-6	16-DU	190.00	10

Bulkhead Unions

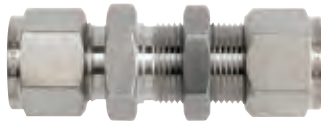

Tube OD	Interchanges	316 Stainless Steel		Pkg Qty
		Part #	Price/E	
1/4"	400-61	4-DBHU-4	\$32.85	10
3/8"	600-61	6-DBHU-6	47.55	10
1/2"	810-61	8-DBHU-8	75.90	10
5/8"	1010-61	10-DBHU-10	98.00	10
3/4"	1210-16	12-DBHU-12	124.00	10
1"	1610-16	16-DBHU-16	242.00	10

Reducers



Tube OD	Interchanges	316 Stainless Steel		Pkg Qty
		Part #	Price/E	
1/4" x 1/8"	400-R-2	4-DRATT-2	\$24.50	10
3/8" x 1/4"	600-R-4	6-DRATT-4	24.50	10
3/8" x 1/2"	600-R-8	6-DRATT-8	25.25	10
1/2" x 3/4"	810-R-12	8-DRATT-12	32.05	10
3/4" x 1/2"	1210-R-8	12-DRATT-8	62.25	10
3/4" x 1"	1210-R-16	12-DRATT-16	68.00	10

Male Elbows



Tube OD	Male NPT	Interchanges	316 Stainless Steel		Pkg Qty
			Part #	Price/E	
1/4"	1/8"-27	400-2-2	4-DME-2	\$28.30	10
	1/4"-18	400-2-4	4-DME-4	28.30	10
3/8"	1/4"-18	600-2-4	6-DME-4	33.95	10
	3/8"-18	600-2-6	6-DME-6	40.75	10
1/2"	1/2"-14	810-2-8	8-DME-8	59.95	10
3/4"	1/2"-14	1210-2-8	12-DME-8	92.45	10
	3/4"	1210-2-12	12-DME-12	103.10	10
1"	3/4"	1610-2-12	16-DME-12	206.00	10
	1"	1610-2-16	16-DME-16	186.00	10

Female Elbows



Tube OD	Female NPT	Interchanges	316 Stainless Steel		Pkg Qty
			Part #	Price/E	
1/4"	1/8"-27	400-8-2	4-DFE-2	\$40.70	10
3/8"	1/4"-18	600-8-4	6-DFE-4	41.35	10
1/2"	1/2"-14	810-8-8	8-DFE-8	80.00	10
3/4"	1/2"	1210-8-8	12-DFE-8	120.00	10
3/4"	3/4"	1210-8-12	12-DFE-12	163.00	10
1"	1"	1610-8-16	16-DFE-16	276.00	10

Instrumentation Fittings

Union Elbows

Tube OD	Interchanges	316 Stainless Steel		Pkg Qty
		Part #	Price/E	
1/4"	400-9	4-DELU-4	\$38.70	10
3/8"	600-9	6-DELU-6	43.50	10
1/2"	810-9	8-DELU-8	65.10	10
5/8"	1010-9	10-DELU-10	97.00	10
3/4"	1210-9	12-DELU-12	130.00	10
1"	1610-9	16-DELU-16	256.00	10



Pipe, Welding
& Tube Fittings

Male Branch Tees

Tube OD	Male NPT	Interchanges	316 Stainless Steel		Pkg Qty
			Part #	Price/E	
1/8"	1/8"-27	200-3TTM	2-DTTM-2	\$49.00	10
1/4"	1/4"-18	400-3-4TTM	4-DTTM-4	56.00	10
1/2"	3/8"	810-3TTM	8-DTTM-6	90.00	10
1/2"	1/2"	810-3-8TTM	8-DTTM-8	96.00	10
3/4"	1/2"	1210-3-8TTM	12-DTTM-8	294.00	10
3/4"	3/4"	1210-3TTM	12-DTTM-12	151.00	10
1"	3/4"	1610-3-12TTM	16-DTTM-12	560.00	10
1"	1"	1610-3-16TTM	16-DTTM-16	650.00	10

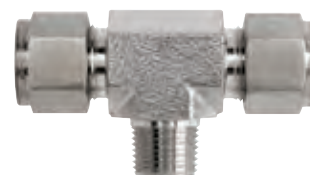

Female Branch Tees

Tube OD	Female NPT	Interchanges	316 Stainless Steel		Pkg Qty
			Part #	Price/E	
1/4"	1/4"-18	400-3-4TTF	4-DTTF-4	\$65.00	10



Union Tees

Tube OD	Interchanges	316 Stainless Steel		Pkg Qty
		Part #	Price/E	
1/4"	400-3	4-DTTT-4	\$55.20	10
3/8"	600-3	6-DTTT-6	76.20	10
1/2"	810-3	8-DTTT-8	109.10	10
5/8"	1010-3	10-DTTT-10	145.00	10
3/4" x 3/8"	1210-3-12-6	12-DTTT-6	235.00	10
3/4" x 1/2"	1210-3-12-8	12-DTTT-8	235.00	10
3/4"	1210-3	12-DTTT-12	191.00	10
1" x 3/4"	1610-3-12-16	16-DTTT-12	500.00	10
1"	1610-3	16-DTTT-16	440.00	10



Male Run Tees

Tube OD	Male NPT	Interchanges	316 Stainless Steel		Pkg Qty
			Part #	Price/E	
1/8"	1/8"-27	200-3TMT	2-DTMT-2	\$49.00	10
1/4"	1/4"-18	400-3-4TMT	4-DTMT-4	56.00	10
3/8"	1/4"-18	600-3TMT	6-DTMT-4	59.40	10
1/2"	3/8"	810-3TMT	8-DTMT-6	90.00	10
1/2"	1/2"	810-3-8TMT	8-DTMT-8	96.00	10
3/4"	3/4"	1210-3TMT	12-DTMT-12	152.00	10
1"	1"	1610-3-16TMT	16-DTMT-16	650.00	10



Instrumentation Fittings

Pipe, Welding & Tube Fittings

Front Ferrules



Tube OD	Interchanges	316 Stainless Steel		Pkg Qty
		Part #	Price/E	
1/8"	203-1	DFC-2	\$2.95	10
1/4"	403-1	DFC-4	3.15	10
3/8"	603-1	DFC-6	3.20	10
1/2"	813-1	DFC-8	3.90	10
5/8"	1013-1	DFC-10	5.85	10
3/4"	1213-1	DFC-12	8.30	10
1"	1613-1	DFC-16	17.00	10

Rear Ferrules



Tube OD	Interchanges	316 Stainless Steel		Pkg Qty
		Part #	Price/E	
1/8"	204-1	DRC-2	\$2.45	10
1/4"	404-1	DRC-4	2.40	10
3/8"	604-1	DRC-6	2.95	10
1/2"	814-1	DRC-8	3.85	10
5/8"	1014-1	DRC-10	13.80	10
3/4"	1214-1	DRC-12	15.50	10
1"	1614-1	DRC-16	41.00	10

Nuts



Tube OD	Interchanges	316 Stainless Steel		Pkg Qty
		Part #	Price/E	
1/4"	402-1	DN-4	\$4.50	10
3/8"	602-1	DN-6	6.25	10
1/2"	812-1	DN-8	10.00	10
5/8"	1012-1	DN-10	13.10	10
3/4"	1212-1	DN-12	16.50	10
1"	1612-1	DN-16	30.00	10

Caps



Tube OD	Interchanges	316 Stainless Steel		Pkg Qty
		Part #	Price/E	
1/4"	400-C	4-DCAP	\$12.75	10
3/8"	600-C	6-DCAP	15.90	10
1/2"	810-C	8-DCAP	26.45	10
5/8"	1010-C	10-DCAP	35.00	10
3/4"	1210-C	12-DCAP	48.00	10
1"	1610-C	16-DCAP	105.00	10

Plugs



Tube OD	Interchanges	316 Stainless Steel		Pkg Qty
		Part #	Price/E	
1/4"	400-P	4-DFPLUG	\$11.10	10
3/8"	600-P	6-DFPLUG	12.80	10
1/2"	810-P	8-DFPLUG	19.00	10
5/8"	1010-P	10-DFPLUG	25.25	10
3/4"	1210-P	12-DFPLUG	31.00	10
1"	1610-P	16-DFPLUG	62.00	10

Compression Fittings

Applications:

- for use with copper, aluminum and Parflex thermoplastic tubing
- not recommended for steel tubing or applications using gaseous media

Features:

- no flaring, soldering or other preparation of tubing necessary to assemble
- manufactured for connection to low and medium pressure tubing connection work where excessive vibration or tube movement is not involved
- Underwriter's Laboratories listed for flammable liquid
- Compression fittings meet functional requirements of SAE J-512 and ASA.

Assembly Instructions:

1. Slide nut, then sleeve onto tubing. The thread end of the nut must face outward.
2. Insert the tube into the fitting. Be sure the tube is bottomed on the fitting shoulder.
3. Assemble nut to body, than tighten hand-tight. Then follow the number of wrench turns as indicated in the table below.

Fitting Size	Tube OD	Tube Wall	Turns required to seal from hand-tight		PSI @ 73°F (23°C)
			60C Series with soft metal tubing	60PT Series with thermoplastic tubing	
2"	1/8"	.030	1¼	-	400
3"	3/16"	.030	1¼	-	400
4"	1/4"	.030	1¼	2	300
5"	5/16"	.032	1¼	2	300
6"	3/8"	.032	2¼	2	200
8"	1/2"	.032	2¼	2	200
10"	5/8"	.035	2¼	2	150
12"	3/4"	.035	2¼	2	100
14"	7/8"	.035	2¼	-	75

Male Connectors

Feature:

- reference SAE 060102 BA

Tube Size	Pipe Thread	Brass	
		Part #	Price/E
1/8"	1/8"	68C-0202	\$3.55
3/16"	1/8"	68C-0302	3.55
3/16"	1/4"	68C-0304	6.10
1/4"	1/8"	68C-0402	2.97
1/4"	1/4"	68C-0404	4.31
1/4"	3/8"	68C-0406	6.75
1/4"	1/2"	68C-0408	10.87
5/16"	1/8"	68C-0502	5.50
5/16"	1/4"	68C-0504	4.75
3/8"	1/8"	68C-0602	4.45
3/8"	1/4"	68C-0604	4.76
3/8"	3/8"	68C-0606	6.07
3/8"	1/2"	68C-0608	8.67
7/16"	1/4"	68C-0704	13.50
1/2"	1/4"	68C-0804	9.24
1/2"	3/8"	68C-0806	10.80
1/2"	1/2"	68C-0808	10.78
5/8"	3/8"	68C-1006	14.41
5/8"	1/2"	68C-1008	13.58
5/8"	3/4"	68C-1012	23.72
3/4"	1/2"	68C-1208	22.19
3/4"	3/4"	68C-1212	28.30
7/8"	3/4"	68C-1412	27.75



Compression Fittings

Female Connectors

Feature:

- reference SAE 060103 BA



Tube Size	Pipe Thread	Brass	
		Part #	Price/E
1/8"	1/8"	66C-0202	\$5.91
3/16"	1/8"	66C-0302	5.40
3/16"	1/4"	66C-0304	16.02
1/4"	1/8"	66C-0402	3.55
1/4"	1/4"	66C-0404	8.78
5/16"	1/8"	66C-0502	7.95
5/16"	1/4"	66C-0504	14.85
3/8"	1/8"	66C-0602	5.50
3/8"	1/4"	66C-0604	8.76
3/8"	3/8"	66C-0606	9.27
3/8"	1/2"	66C-0608	14.15
1/2"	1/4"	66C-0804	15.66
1/2"	3/8"	66C-0806	12.95
1/2"	1/2"	66C-0808	19.31
5/8"	1/2"	66C-1008	18.75

Unions

Feature:

- reference SAE 060101 BA



Tube Size	Brass	
	Part #	Price/E
1/8"	62C-02	\$6.65
3/16"	62C-03	4.86
1/4"	62C-04	4.50
5/16"	62C-05	6.33
3/8"	62C-06	5.67
7/16"	62C-07	28.07
1/2"	62C-08	13.42
5/8"	62C-10	18.18
3/4"	62C-12	37.82
7/8"	62C-14	44.20

Union Reducers

Feature:

- reference SAE 060101 BA



Tube Size	Brass	
	Part #	Price/E
3/16" x 1/4"	62C-0403	\$13.15
1/4" x 3/8"	62C-0604	13.01
3/8" x 1/2"	62C-0806	24.82
3/8" x 5/8"	62C-1006	17.85

Bulkhead Unions



Tube Size	Brass	
	Part #	Price/E
1/4"	62CBH-04	\$13.73
3/8"	62CBH-06	27.06

Compression Fittings

Straight Through Tank Fittings

Tube Size	Pipe Thread	Brass	
		Part #	Price/E
3/16"	1/8"	682C-0302	\$12.45
3/8"	3/8"	682C-0606	17.98
1/2"	1/2"	682C-0808	24.05



Female Elbows

Feature:

- reference SAE 060203 BA

Tube Size	Pipe Thread	Brass	
		Part #	Price/E
1/8"	1/8"	170C-0202	\$11.33
3/16"	1/8"	170C-0302	13.00
1/4"	1/8"	170C-0402	10.26
1/4"	1/4"	170C-0404	15.29
3/8"	1/4"	170C-0604	16.11
3/8"	3/8"	170C-0606	18.82
7/16"	1/4"	170C-0704	28.00
1/2"	3/8"	170C-0806	19.66



Male Elbows

Feature:

- reference SAE 060202 BA

Tube Size	Pipe Thread	Brass	
		Part #	Price/E
1/8"	1/8"	269C-0202	\$6.17
3/16"	1/8"	169C-0302	9.07
3/16"	1/4"	169C-0304	17.86
1/4"	1/8"	169C-0402	7.30
1/4"	1/4"	169C-0404	7.56
1/4"	3/8"	169C-0406	18.18
5/16"	1/8"	169C-0502	12.10
5/16"	1/4"	169C-0504	12.20
5/16"	3/8"	169C-0506	27.03
3/8"	1/8"	169C-0602	10.61
3/8"	1/4"	169C-0604	8.30
3/8"	3/8"	169C-0606	10.22
3/8"	1/2"	169C-0608	18.07
1/2"	1/4"	169C-0804	19.97
1/2"	3/8"	169C-0806	14.96
1/2"	1/2"	169C-0808	19.92
5/8"	1/2"	169C-1008	24.55
3/4"	1/2"	169C-1208	39.85
3/4"	3/4"	169C-1212	39.85



45° Elbows

Tube Size	Pipe Thread	Brass	
		Part #	Price/E
1/4"	1/8"	179C-0402	\$13.24
1/4"	1/4"	179C-0404	15.55
3/8"	1/8"	179C-0602	24.56
3/8"	1/4"	179C-0604	17.92
3/8"	3/8"	179C-0606	24.68
1/2"	3/8"	179C-0806	30.38



Compression Fittings

Union Elbows

Feature:

- reference SAE 060201 BA



Tube Size	Brass	
	Part #	Price/E
1/8"	165C-02	\$19.10
3/16"	165C-03	10.26
1/4"	165C-04	10.51
5/16"	165C-05	16.22
3/8"	165C-06	9.85
7/16"	165C-07	23.85
1/2"	165C-08	23.10
5/8"	165C-10	27.27
3/4"	165C-12	53.87

Male Branch Tees

Feature:

- reference SAE 060425 BA



Tube Size	Pipe Thread	Brass	
		Part #	Price/E
1/8"	1/8"	172C-0202	\$15.40
3/16"	1/8"	172C-0302	15.36
1/4"	1/8"	172C-0402	10.75
1/4"	1/4"	172C-0404	13.75
3/8"	1/8"	172C-0602	18.00
3/8"	1/4"	172C-0604	14.90
3/8"	3/8"	172C-0606	22.00
1/2"	3/8"	172C-0806	26.46

Female Branch Tee



Tube Size	Pipe Thread	Brass	
		Part #	Price/E
1/4"	1/8"	177C-0402	\$17.19

Union Tees

Feature:

- reference SAE 060401 BA



Tube Size 1 and 2	Tube Size 3	Brass	
		Part #	Price/E
1/8"	1/8"	164C-02	\$20.87
3/16"	3/16"	264C-03	16.62
1/4"	1/4"	164C-04	11.30
5/16"	5/16"	164C-05	17.25
3/8"	3/8"	164C-06	14.90
1/2"	1/2"	164C-08	28.65
5/8"	5/8"	164C-10	47.45
3/4"	3/4"	164C-12	102.65
3/8"	1/4"	164C-06-06-04	18.34
1/2"	3/8"	164C-08-08-06	71.60

Compression Fittings

Male Run Tees

Feature:

- reference SAE 060424 BA

Tube Size	Pipe Thread	Brass	
		Part #	Price/E
3/16"	1/8"	171C-0302	\$15.95
1/8"	1/8"	171C-0202	15.95
1/4"	1/8"	171C-0402	12.10
1/4"	1/4"	171C-0404	14.40
3/8"	1/4"	171C-0604	17.00



Adapter Tee

Tube Size	Male Pipe Thread	Female Straight Thread	Brass	
			Part #	Price/E
1/4"	1/8"	7/16"-24	176C-0402	\$12.45



Seal Plug

Tube Size	Brass	
	Part #	Price/E
1/4"	639C-04	\$4.32



Inserts

Tube Size	Wall Thickness	Brass	
		Part #	Price/E
1/8"	.016"	63PT-0216	\$0.96
1/8"	.023"	63PT-0223	1.15
3/16"	.025"	63PT-0325	1.05
3/16"	.040"	63PT-0340	0.86
1/4"	.040"	63PT-0440	0.72
1/4"	.062"	63PT-0462	1.25
5/16"	.040"	63PT-0540	1.80
5/16"	.062"	63PT-0562	1.12
3/8"	.062"	63PT-0662	0.80
1/2"	.062"	63PT-0862	1.06
5/8"	.062"	63PT-1062	2.11



- Acetal sleeves and brass inserts allow for standard compression fittings to be used with industrial grades of thermoplastic tubing.

Brass Sleeves

Feature:

- reference SAE 060115

Tube Size	Brass	
	Part #	Price/E
1/8"	60C-02	\$0.72
3/16"	60C-03	0.72
1/4"	60C-04	0.72
5/16"	60C-05	0.72
3/8"	60C-06	0.72
7/16"	60C-07	2.79
1/2"	60C-08	1.07
5/8"	60C-10	1.45
3/4"	60C-12	1.98
7/8"	60C-14	4.14



Compression Fittings

Acetal Sleeves



Tube Size	Acetal	
	Part #	Price/E
1/4"	60PT-04	\$0.76
5/16"	60PT-05	0.96
3/8"	60PT-06	0.86
1/2"	60PT-08	1.06
5/8"	60PT-10	1.55

- Acetal sleeves and brass inserts allow for standard compression fittings to be used with industrial grades of thermoplastic tubing.

Nuts

Feature:

- reference SAE 060110



Tube Size	Straight Thread	Brass	
		Part #	Price/E
1/8"	5/16"-24	61C-02	\$1.11
3/16"	3/8"-24	61C-03	1.20
1/4"	7/16"-24	61C-04	1.15
5/16"	1/2"-24	61C-05	1.55
3/8"	9/16"-24	61C-06	1.39
7/16"	5/8"-24	61C-07	3.33
1/2"	11/16"-20	61C-08	2.97
5/8"	13/16"-18	61C-10	5.40
3/4"	1"-18	61C-12	9.49
7/8"	1-1/8"-18	61C-14	10.92

Long Nuts

Feature:

- reference SAE 060111



Tube Size	Straight Thread	Brass	
		Part #	Price/E
1/4"	7/16"-24	61CL-04	\$2.86
5/16"	1/2"-24	61CL-05	13.50
3/8"	9/16"-24	61CL-06	4.95
1/2"	11/16"-20	61CL-08	10.38
5/8"	13/16"-18	61CL-10	18.52
3/4"	1"-18	61CL-12	18.90

Brass SAE 45° Flare Fittings

Applications:

- for use with copper, brass, aluminum and welded steel hydraulic tubing that can be flared

Features:

- economical fitting
- resists mechanical pullout
- easy to disassemble and may be reassembled repeatedly, for a leak-proof connection
- manufactured from CA 360, CA 345, or CA377 brass
- for use with hard-to-hold liquids and gases
- Listed with Underwriter's Laboratories for flammable liquid, marine, refrigeration and gas applications. Meets functional requirements of SAE J512 and J513, ASA and MS (Military Standards).
- temperature range: **-65°F to 250°F (-54°C to 121°C)**

Working Pressure Ranges:

Temperature and type of tubing used are important factors, the following table is a general guide for proper selection. The PSI rating given is based on a temperature of **73°F (22°C)** using copper tubing.

PSI	Tube OD	Tube Wall
1400	1/4"	.030
1000	3/8"	.032
750	1/2"	.032
650	5/8"	.035
550	3/4"	.035

Assembly Instructions:

1. Cut tubing squarely and clean tube end thoroughly to remove burrs.
2. Place nut onto tube. Place threaded end of nut toward end of tube.
3. Flare tube end with flaring tool to provide 45° flare (flare tools are available, please contact Dixon® for pricing and availability).
4. Clamp tube flare between nut and nose of fitting body by screwing nut on finger-tight. Tighten with a wrench an additional 1/4 turn for a metal-to-metal seal.

Male Connectors

Feature:

- reference SAE 010102

Tube Size	Pipe Size	Straight Thread	Hex	Brass	
				Part #	Price/E
1/4"	1/4"	7/16"-20	9/16"	48F-4-4	\$2.55
1/4"	3/8"	7/16"-20	11/16"	48F-4-6	4.45
1/4"	1/2"	7/16"-20	7/8"	48F-4-8	12.35
3/8"	1/8"	5/8"-18	5/8"	48F-6-2	4.60
3/8"	1/4"	5/8"-18	5/8"	48F-6-4	3.50
3/8"	3/8"	5/8"-18	11/16"	48F-6-6	4.00
3/8"	1/2"	5/8"-18	7/8"	48F-6-8	5.90
1/2"	1/4"	3/4"-16	3/4"	48F-8-4	7.30
1/2"	3/8"	3/4"-16	3/4"	48F-8-6	4.80
1/2"	1/2"	3/4"-16	7/8"	48F-8-8	6.45
5/8"	3/8"	7/8"-14	7/8"	48F-10-6	6.95
3/4"	3/4"	1-1/16"-14	1-1/16"	48F-12-12	13.50



Female Connectors

Feature:

- reference SAE 010103

Tube Size	Pipe Size	Straight Thread	Hex	Brass	
				Part #	Price/E
1/4"	1/4"	7/16"-20	11/16"	46F-4-4	\$4.30
3/8"	1/4"	5/8"-18	11/16"	46F-6-4	4.95
3/8"	3/8"	5/8"-18	13/16"	46F-6-6	7.65
3/8"	1/2"	5/8"-18	1"	46F-6-8	12.50
1/2"	1/4"	3/4"-16	3/4"	46F-8-4	7.70
1/2"	3/8"	3/4"-16	13/16"	46F-8-6	7.45
5/8"	3/8"	7/8"-14	7/8"	46F-10-6	11.80



Brass SAE 45° Flare Fittings

Unions



Feature:

- reference SAE 010101

Tube Size	Straight Thread	Hex	Brass	
			Part #	Price/E
1/4"	7/16"-20	7/16"	42F-4	\$2.05
3/8"	5/8"-18	5/8"	42F-6	4.80
1/2"	3/4"-16	3/4"	42F-8	5.95

Male Elbows

Feature:

- reference SAE 010202



Tube Size	Pipe Size	Straight Thread	Brass	
			Part #	Price/E
1/4"	1/8"	7/16"-20	149F-4-2	\$4.60
1/4"	1/4"	7/16"-20	149F-4-4	6.55
1/4"	3/8"	7/16"-20	149F-4-6	12.25
3/8"	1/4"	5/8"-18	149F-6-4	7.90
3/8"	3/8"	5/8"-18	149F-6-6	9.20
3/8"	1/2"	5/8"-18	149F-6-8	11.60
1/2"	1/4"	3/4"-16	149F-8-4	11.90
1/2"	3/8"	3/4"-16	149F-8-6	8.85
1/2"	1/2"	3/4"-16	149F-8-8	9.60
5/8"	1/2"	7/8"-14	149F-10-8	12.30
3/4"	3/4"	1-1/16"-14	149F-12-12	22.15

Female Elbows

Feature:

- reference SAE 010203



Tube Size	Pipe Size	Straight Thread	Brass	
			Part #	Price/E
1/4"	1/4"	7/16"-20	150F-4-4	\$11.10
3/8"	3/8"	5/8"-18	150F-6-6	14.95
3/8"	1/2"	5/8"-18	150F-6-8	24.95

90° Swivel Elbows



Tube Size	Straight Thread	Brass	
		Part #	Price/E
1/4"	7/16"-20	166FSV-4-4	\$13.45
3/8"	5/8"-18	166FSV-6-6	16.85
1/2"	3/4"-16	166FSV-8-8	22.50

Brass SAE 45° Flare Fittings

45° Elbows

Feature:

- reference SAE 010302

Tube Size	Pipe Size	Straight Thread	Brass	
			Part #	Price/E
1/4"	1/4"	7/16"-20	159F-4-4	\$10.10
3/8"	1/4"	5/8"-18	159F-6-4	7.70
3/8"	3/8"	5/8"-18	159F-6-6	7.05
1/2"	1/4"	3/4"-16	159F-8-4	21.50
1/2"	3/8"	3/4"-16	159F-8-6	7.45
1/2"	1/2"	3/4"-16	159F-8-8	13.95



Pipe, Welding
& Tube Fittings

Union Tees

Feature:

- reference SAE 010401

Tube Size	Straight Thread	Brass	
		Part #	Price/E
1/4"	7/16"-20	144F-4	\$7.60
3/8"	5/8"-18	144F-6	13.00
1/2"	3/4"-16	144F-8	15.85

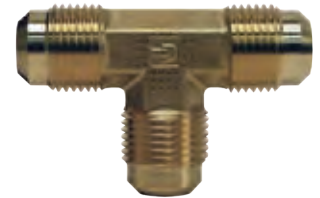

Short Nuts

Features:

- short nut for use when vibration is minimal
- reference SAE 010110

Tube Size	Straight Thread	Hex	Brass	
			Part #	Price/E
1/4"	7/16"-20	9/16"	41FS-4	\$1.95
3/8"	5/8"-18	3/4"	41FS-6	3.45
1/2"	3/4"-16	7/8"	41FS-8	4.85



Long Nuts

Features:

- long nut offers additional vibration capacity
- reference SAE 010111

Tube Size	Straight Thread	Hex	Brass	
			Part #	Price/E
1/4"	7/16"-20	9/16"	41FL-4	\$2.75
3/8"	5/8"-18	3/4"	41FL-6	6.85
1/2"	3/4"-16	7/8"	41FL-8	8.55



Flareless Bite Fittings

Applications:

- chemical, pulp and paper, oil and gas refineries, military, air compressors and machine tools
- well-suited for a variety of processing and general hydraulic applications

Features:

- Ideally suited for use with tubing having medium to extra heavy wall thicknesses.
- 3 piece design, with only one ferrule eliminates possible make-up errors that may occur using a twin ferrule tube fitting.
- Minimal risk of improper assembly as the ferrule visibly bites into the tubing, allowing installer to visually inspect the bite quality.
- fittings are suitable for sub-zero through elevated temperature applications
- temperature rating is limited by the material chosen
- pressure ratings are determined by the size (OD) and wall thickness (inches/mm) of the tubing on which they are to be installed

Specifications:

- exceeds Military (MIL F18866) and SAE J514 standards

Assembly Instructions:

- cut, de-burr and clean tubing
- pre-set ferrule onto tubing
- inspect ferrule bite in tubing by disassembling the fitting and visually inspecting the de-burred end of tube for slight indentation
- finger tighten nut and then further wrench tighten nut another 1/3 to 1/2 turn



Male Tube x Male NPTF Adapters

Tube OD	Male NPTF	Steel	
		Part #	Price/E
1/8"	1/8"	FLC2404-02	\$7.85
1/8"	1/4"	FLC2404-02-04	7.75
3/16"	1/8"	FLC2404-03-02	8.40
1/4"	1/8"	FLC2404-04-02	5.75
1/4"	1/4"	FLC2404-04	7.45
1/4"	3/8"	FLC2404-04-06	8.75
1/4"	1/2"	FLC2404-04-08	10.10
5/16"	1/8"	FLC2404-05-02	9.25
5/16"	1/4"	FLC2404-05-04	10.65
3/8"	1/8"	FLC2404-06-02	12.10
3/8"	1/4"	FLC2404-06-04	7.70
3/8"	3/8"	FLC2404-06	9.60
3/8"	1/2"	FLC2404-06-08	9.50
1/2"	1/4"	FLC2404-08-04	11.30
1/2"	3/8"	FLC2404-08-06	10.80
1/2"	1/2"	FLC2404-08	9.45
1/2"	3/4"	FLC2404-08-12	17.10
5/8"	3/8"	FLC2404-10-06	12.85
5/8"	1/2"	FLC2404-10-08	12.50
5/8"	3/4"	FLC2404-10-12	33.50
3/4"	1/2"	FLC2404-12-08	19.50
3/4"	3/4"	FLC2404-12	18.25
3/4"	1"	FLC2404-12-16	34.45
1"	3/4"	FLC2404-16-12	32.75
1"	1"	FLC2404-16	29.95
1"	1-1/4"	FLC2404-16-20	45.80
1-1/4"	3/4"	FLC2404-20-12	169.65
1-1/4"	1-1/4"	FLC2404-20	65.00
1-1/2"	1-1/2"	FLC2404-24	72.95

Male Tube x Male 37° JIC



Tube OD	Male 37° JIC	Steel	
		Part #	Price/E
1/4"	1/4"	FLC2402-04-04	\$21.10
3/8"	3/8"	FLC2402-06-06	24.10
1/2"	1/2"	FLC2402-08-08	36.55
3/4"	3/4"	FLC2402-12-12	68.20

Male Tube x Female NPTF Adapters

Tube OD	Female NPTF	Steel	
		Part #	Price/E
1/8"	1/8"	FLC2405-02	\$14.55
1/4"	1/8"	FLC2405-04-02	7.25
1/4"	1/4"	FLC2405-04	7.55
5/16"	1/8"	FLC2405-05-02	11.95
3/8"	1/4"	FLC2405-06-04	9.00
3/8"	3/8"	FLC2405-06	10.20
1/2"	1/4"	FLC2405-08-04	12.95
1/2"	3/8"	FLC2405-08-06	13.05
1/2"	1/2"	FLC2405-08	13.05
5/8"	1/2"	FLC2405-10-08	13.55
3/4"	3/4"	FLC2405-12	21.55
1"	1"	FLC2405-16	32.65
1-1/4"	1 1/4"	FLC2405-20	83.35



Pipe, Welding
& Tube Fittings

Tube Unions

Tube OD	Steel	
	Part #	Price/E
1/8"	FLC2403-02	\$18.15
3/16"	FLC2403-03	13.25
1/4"	FLC2403-04	9.70
5/16"	FLC2403-05	28.45
3/8"	FLC2403-06	12.50
1/2"	FLC2403-08	16.55
5/8"	FLC2403-10	21.15
3/4"	FLC2403-12	29.85
1"	FLC2403-16	46.40
1-1/4"	FLC2403-20	76.00
1-1/2"	FLC2403-24	159.10



Male Tube x Male NPTF Adapter 90° Elbows

Tube OD	Male NPTF	Steel	
		Part #	Price/E
1/8"	1/8"	FLC2501-02	\$11.45
3/16"	1/8"	FLC2501-03-02	13.15
1/4"	1/8"	FLC2501-04-02	7.60
1/4"	1/4"	FLC2501-04	10.60
1/4"	3/8"	FLC2501-04-06	13.50
5/16"	1/8"	FLC2501-05-02	17.85
5/16"	1/4"	FLC2501-05-04	11.65
3/8"	1/8"	FLC2501-06-02	15.65
3/8"	1/4"	FLC2501-06-04	10.25
3/8"	3/8"	FLC2501-06	14.05
3/8"	1/2"	FLC2501-06-08	17.25
1/2"	1/4"	FLC2501-08-04	14.30
1/2"	3/8"	FLC2501-08-06	14.50
1/2"	1/2"	FLC2501-08	20.70
1/2"	3/4"	FLC2501-08-12	44.00
5/8"	3/8"	FLC2501-10-06	27.15
5/8"	1/2"	FLC2501-10-08	18.80
3/4"	1/2"	FLC2501-12-08	54.50
3/4"	3/4"	FLC2501-12	27.00
1"	3/4"	FLC2501-16-12	48.35
1"	1"	FLC2501-16	43.60
1 1/4"	1 1/4"	FLC2501-20	84.00
1 1/2"	1 1/2"	FLC2501-24	128.65





Male Union 90° Elbows

Tube OD	Steel	
	Part #	Price/E
1/4"	FLC2500-04	\$10.80
5/16"	FLC2500-05	22.95
3/8"	FLC2500-06	13.70
1/2"	FLC2500-08	17.70
5/8"	FLC2500-10	25.20
3/4"	FLC2500-12	36.35
1"	FLC2500-16	59.45
1-1/4"	FLC2500-20	201.10

Male Tube Union Tees



Tube OD	Steel	
	Part #	Price/E
1/8"	FLC2603-02	\$16.55
3/16"	FLC2603-03	31.65
1/4"	FLC2603-04	20.40
5/16"	FLC2603-05	26.55
3/8"	FLC2603-06	22.05
1/2"	FLC2603-08	30.15
5/8"	FLC2603-10	44.70
3/4"	FLC2603-12	55.00
1"	FLC2603-16	87.65
1-1/4"	FLC2603-20	240.95

Ferrules



Tube OD	Steel	
	Part #	Price/E
1/8"	FLC0319-02	\$2.35
3/16"	FLC0319-03	3.65
1/4"	FLC0319-04	1.80
5/16"	FLC0319-05	5.75
3/8"	FLC0319-06	2.10
1/2"	FLC0319-08	2.70
5/8"	FLC0319-10	3.55
3/4"	FLC0319-12	4.90
1"	FLC0319-16	7.75
1-1/4"	FLC0319-20	18.15
1-1/2"	FLC0319-24	25.85

Nuts



Tube OD	Steel	
	Part #	Price/E
1/8"	FLC0318-02	\$2.05
3/16"	FLC0318-03	1.55
1/4"	FLC0318-04	1.75
5/16"	FLC0318-05	3.15
3/8"	FLC0318-06	1.45
1/2"	FLC0318-08	2.25
5/8"	FLC0318-10	3.75
3/4"	FLC0318-12	4.95
1"	FLC0318-16	9.15
1-1/4"	FLC0318-20	14.60
1-1/2"	FLC0318-24	22.85

Sharkbite® Push to Connect Fittings

Applications:

- for **water, dry, clean air** or **100% glycol solutions** only
- connects copper, CPVC, and PEX pipe in any combination
- approved for use underground and behind walls without access panels



Features:

- no soldering, clamps, unions or glue needed
- pressure rating: **200 PSI at 200°F (93°C)**
- integral tube liner for PEX installations
- Fittings can be rotated after assembly for easier installation in tight spaces.
- easy to disconnect if needed
- design certified and listed to ASSE 1061/NSF 61
- listed by IAPMO
- meets UPC, IPC and cUPC requirements
- all Sharkbite® fittings are lead free

Straight Couplings

Tube Size	Forged Brass	
	Part #	Price/E
1/2" x 1/2"	U008	\$19.10
3/4" x 3/4"	U016	22.75
1" x 1"	U020	48.00



Reducing Couplings

Tube Size	Forged Brass	
	Part #	Price/E
3/4" x 1/2"	U058	\$22.75
1" x 3/4"	U060	52.50



Straight Connectors

Tube Size	Female NPT	Forged Brass	
		Part #	Price/E
1/2"	1/2"	U072	\$15.25
3/4"	3/4"	U088	18.20
1"	1"	U094	38.25



Tube Size	Male NPT	Forged Brass	
		Part #	Price/E
1/2"	1/2"	U120	\$15.25
3/4"	3/4"	U134	18.20
1"	1"	U140	38.25



Reducing Connectors

Tube Size	Female NPT	Forged Brass	
		Part #	Price/E
1/2"	3/4"	U068	\$18.20



Tube Size	Male NPT	Forged Brass	
		Part #	Price/E
1/2"	3/4"	U116	\$18.20



Sharkbite® Push to Connect Fittings

Elbows



Tube Size	Forged Brass	
	Part #	Price/E
1/2" x 1/2"	U248	\$21.00
3/4" x 3/4"	U256	25.50
1" x 1"	U260	52.50

Drop Ear Elbow



Tube Size	Female NPT	Forged Brass	
		Part #	Price/E
1/2"	1/2"	U334	\$21.00

Tees



Tube Size	Forged Brass	
	Part #	Price/E
1/2"	U362	\$29.00
3/4"	U370	34.50

Reducing Tee



Tube Size (2)	Tube Size	Forged Brass	
		Part #	Price/E
3/4"	1/2"	U412	\$34.50

End Stops



Tube Size	Forged Brass	
	Part #	Price/E
1/2"	U514	\$17.25
3/4"	U518	21.00
1"	U520	43.25

Slip Couplings

Application:

- for use with copper pipe only



Tube Size	Forged Brass	
	Part #	Price/E
1/2"	U3008	\$38.25
3/4"	U3016	45.50

Disconnect Clips





Size	ABS Plastic	
	Part #	Price/E
1/2"	U710	\$4.50
3/4"	U712	4.50
1"	U714	4.85

LIQUIfit™ Fittings

Application:

- Suitable for water, potable liquids and neutral gas applications: including water filtration, water coolers, coffee machines and beverage dispensers.

Features:

- EPDM seal secures connection with larger surface area than standard O-rings
- engineered polymer allows superior mechanical strength and chemical resistance
- full stainless gripping ring eliminates the need for locking clips
- release button protects and supports tubing
- FDA compliant
- meets California and Vermont <0.25% lead requirements
- NSF-51 listed for contact with food
- NSF-61 list C-Hot rated
- in compliance with the following standards:   

Specifications:

- working pressure:
 - 1/4" **230 PSI** from 35°F to 100°F (1.7°C to 38°C)
150 PSI at 150°F (66°C)
60 PSI at 200°F (93°C)
 - 3/8" **190 PSI** from 35°F to 100°F (1.7°C to 38°C)
100 PSI at 150°F (66°C)
60 PSI at 200°F (93°C)
 - 1/2" **160 PSI** from 35°F to 100°F (1.7°C to 38°C)
100 PSI at 150°F (66°C)
60 PSI at 200°F (93°C)
- maximum torque values for NPTF threads:
 - 1/8" and 1/4" 1.0 ft. lbs. / 1.5Nm
 - 3/8" and 1/2" 2.2 ft. lbs. / 3.0Nm

Male Connectors

Tube OD	Male NPTF	Nylon		Pkg Qty
		Part #	Price/E	
1/4"	1/8"	65055611WP2	\$2.55	10
	1/4"	65055614WP2	3.15	10
3/8"	1/4"	65056014WP2	4.25	10
	3/8"	65056018WP2	4.85	10
1/2"	3/8"	65056218WP2	6.70	5
	1/2"	65056222WP2	7.40	5



Female Connectors

Tube OD	Female NPTF	Nylon		Pkg Qty
		Part #	Price/E	
1/4"	1/4"	63155614WP2	\$6.00	10
3/8"	3/8"	63156018WP2	6.90	10



Faucet Connectors

Tube OD	Female UNS	Nylon		Pkg Qty
		Part #	Price/E	
1/4"	7/16-24	632556133WP2	\$4.90	10
3/8"	7/16-24	632560133WP2	5.50	10



Fixed Elbows

Tube OD	Male NPTF	Nylon		Pkg Qty
		Part #	Price/E	
1/4"	1/8"	65795611WP2	\$3.90	10
	1/4"	65795614WP2	4.60	10
	3/8"	65795618WP2	5.20	10
3/8"	1/4"	65796014WP2	5.75	10
	3/8"	65796018WP2	5.90	10



LIQUIfit™ Fittings

Union Elbows



Tube OD	Nylon		Pkg Qty
	Part #	Price/E	
1/4"	63025600WP2	\$4.30	10
3/8"	63026000WP2	6.30	10
1/2"	63026200WP2	8.30	5

Union Tees



Tube OD	Nylon		Pkg Qty
	Part #	Price/E	
1/4"	63045600WP2	\$5.60	10
3/8"	63046000WP2	7.35	10
1/2"	63046200WP2	8.85	5

Union Connectors



Tube OD 1	Tube OD 2	Nylon		Pkg Qty
		Part #	Price/E	
1/4"	1/4"	63065600WP2	\$3.70	10
	3/8"	63065660WP2	5.50	10
3/8"	3/8"	63066000WP2	5.05	10
	1/2"	63066062WP2	7.30	5
1/2"	1/2"	63066200WP2	6.05	5

Unequal Union Tee



Branch Tube OD (1)	Run Tube OD (2)	Nylon		Pkg Qty
		Part #	Price/E	
1/4"	3/8"	63046056WP2	\$8.25	10

Bulkhead Unions



Tube OD	Nylon		Pkg Qty
	Part #	Price/E	
1/4"	63165600WP2	\$7.10	10
3/8"	63166000WP2	9.55	10
1/2"	63166200WP2	12.60	5

Union Y Connectors



Tube OD	Nylon		Pkg Qty
	Part #	Price/E	
1/4"	63405600WP2	\$6.15	10
3/8"	63406000WP2	7.15	10
1/2"	63406200WP2	11.95	5

LIQUIfit™ Fittings

Swivel Elbows

Tube OD	Male NPTF	Nylon		Pkg Qty
		Part #	Price/E	
1/4"	1/8"	65095611WP2	\$6.30	10
	1/4"	65095614WP2	6.30	10
	3/8"	65095618WP2	6.80	10
3/8"	1/4"	65096014WP2	8.65	10
	3/8"	65096018WP2	9.55	10
1/2"	3/8"	65096218WP2	12.35	4
	1/2"	65096222WP2	12.10	4



Pipe, Welding
& Tube Fittings

Swivel Branch Tees

Tube OD	Male NPTF	Nylon		Pkg Qty
		Part #	Price/E	
1/4"	1/8"	65085611WP2	\$7.45	10
	1/4"	65085614WP2	7.45	10
	3/8"	65085618WP2	7.95	10
3/8"	1/4"	65086014WP2	9.50	10
	3/8"	65086018WP2	9.95	10



Swivel Male Run Tees

Tube OD	Male NPTF	Nylon		Pkg Qty
		Part #	Price/E	
1/4"	1/8"	65035611WP2	\$7.45	10
	1/4"	65035614WP2	7.45	10
	3/8"	65035618WP2	7.95	10
3/8"	1/4"	65036014WP2	9.50	10
	3/8"	65036018WP2	9.65	10



Stem Adapters

Tube OD	Male NPTF	Nylon		Pkg Qty
		Part #	Price/E	
1/4"	1/4"	65215614WP2	\$1.50	10
	3/8"	65215618WP2	2.05	10
3/8"	1/4"	65216014WP2	1.75	10
	3/8"	65216018WP2	2.20	10
1/2"	3/8"	65216218WP2	3.35	5
	1/2"	65216222WP2	3.35	5



End Stops

Tube OD	Nylon		Pkg Qty
	Part #	Price/E	
1/4"	63515600WP2	\$2.80	10
3/8"	63516000WP2	3.25	10



Plugs

Tube OD	Nylon		Pkg Qty
	Part #	Price/E	
1/4"	63265600WP2	\$1.15	10
3/8"	63266000WP2	1.75	10
1/2"	63266200WP2	2.58	5



LIQUIfit™ Fittings

Hose Stems



Tube OD	Stem	Nylon		Pkg Qty
		Part #	Price/E	
1/4"	1/4"	63225656WP2	\$2.35	10
3/8"	1/4"	63226056WP2	3.20	10
	5/16"	63226008WP2	3.50	10
	3/8"	63226060WP2	3.70	10
1/2"	3/8"	63226260WP2	4.00	10

Plug-in Reducers



Tube OD	Plug-in	Nylon		Pkg Qty
		Part #	Price/E	
1/4"	5/16"	63665608WP2	\$3.90	10
1/4"	3/8"	63665660WP2	4.30	10
3/8"	1/2"	63666062WP2	7.60	5

Plug-in Elbows



Tube OD	Plug-in	Nylon		Pkg Qty
		Part #	Price/E	
1/4"	1/4"	63825600WP2	\$3.80	10
3/8"	3/8"	63826000WP2	6.40	10
1/2"	1/2"	63826200WP2	7.60	5

Plug-in Tees



Tube OD	Plug-in	Nylon		Pkg Qty
		Part #	Price/E	
1/4"	1/4"	63885600WP2	\$5.60	10
3/8"	3/8"	63886000WP2	8.85	10
1/2"	1/2"	63886200WP2	10.85	5

TrueSeal™ Ball Valves

Application:

These corrosion resistant, all-plastic designed ball valves are ideal for water filtration units, coffee and beverage machines and a wide variety of other fluid applications.

Features:

- EPDM seal secures connection with larger surface area than standard O-rings
- full flow self-cleaning ball
- high-temperature, scale resistant Polysulfone ball
- glass-reinforced Polypropylene body
- FDA compliant
- NSF-51 listed for contact with food
- certified to NSF-61

Specifications:

- temperature range: **0°F to 225°F (-18°C to 107°C)**
- O-ring seal material: EPDM
- maximum operating pressure: **150 PSI**
- Burst pressure **600 PSI**
- Actual working pressures will be lower at elevated temperatures.

Tube to Male NPTF

Tube OD	Male NPTF	Polypropylene		Pkg Qty
		Part #	Price/E	
1/4"	1/4"	PP4VMC4-MG	\$13.75	10
	3/8"	PP4VMC6-MG	17.60	10
3/8"	1/4"	PP6VMC4-MG	14.15	10
	3/8"	PP6VMC6-MG	14.20	10



Tube to Female NPTF

Tube OD	Female NPTF	Polypropylene		Pkg Qty
		Part #	Price/E	
1/4"	1/8"	PP4VFC2-MG	\$17.45	10
	1/4"	PP4VFC4-MG	16.75	10
	3/8"	PP4VFC6-MG	16.75	10
3/8"	1/8"	PP6VFC2-MG	18.05	10
	1/4"	PP6VFC4-MG	17.35	10
	3/8"	PP6VFC6-MG	17.35	10



Tube to Male NPTF Elbows

Tube OD	Male NPTF	Polypropylene		Pkg Qty
		Part #	Price/E	
1/4"	1/4"	PP4VME4-MG	\$14.55	10
	3/8"	PP4VME6-MG	19.00	10
	1/2"	PP4VME8-MG	23.20	10
3/8"	1/4"	PP6VME4-MG	14.25	10
	3/8"	PP6VME6-MG	17.15	10
	1/2"	PP6VME8-MG	24.05	10



Tube to Female NPTF Elbows

Tube OD	Female NPTF	Polypropylene		Pkg Qty
		Part #	Price/E	
1/4"	1/4"	PP4VFE4-MG	\$14.90	10
	3/8"	PP4VFE6-MG	17.15	10
3/8"	1/4"	PP6VFE4-MG	15.85	10
	3/8"	PP6VFE6-MG	14.25	10



TrueSeal™ Ball Valves

Tube to Tube Unions



Tube OD 1	Tube OD 2	Polypropylene		Pkg Qty
		Part #	Price/E	
1/4"	1/4"	PP4VUC4-MG	\$13.15	10
3/8"	1/4"	PP4VUC6-MG	16.45	10
3/8"	3/8"	PP6VUC6-MG	14.70	10

Tube to Tube Elbow Unions



Tube OD 1	Tube OD 2	Polypropylene		Pkg Qty
		Part #	Price/E	
1/4"	1/4"	PP4VEU4-MG	\$21.10	10
	3/8"	PP4VEU6-MG	20.35	10
3/8"	1/4"	PP6VEU4-MG	19.60	10
	3/8"	PP6VEU6-MG	18.65	10

Tube to Plug-in Elbow Unions



Tube OD	Stem	Polypropylene		Pkg Qty
		Part #	Price/E	
1/4"	3/8"	PP4VTEU6-MG	\$18.65	10
3/8"	3/8"	PP6VTEU6-MG	21.45	10

TrueSeal™ Check Valves

Application:

Push-to connect check valves ensure protection against reversal of flow. The valves have an arrow molded into the body to indicate the direction of flow. Valves are designed for connection with either thermoplastic or soft metal tubing and are intended for use with liquids only. 

Features:

- body material: acetal
- O-ring: EPDM
- metal grip edge: 300 stainless steel
- NSF-51 listed
- maximum operating pressure: **150 PSI** (dependent on tubing used)
- temperature range: **34°F to 150°F (1°C to 65°C)**
- cracking pressure: 1/3 PSI



Tube to Tube Unions

Tube OD	Acetal		Pkg Qty
	Part #	Price/E	
1/4"	A4VC4-MG	\$23.00	25
3/8"	A6VC6-MG	26.95	25

Double Female Hex Adapters

Feature:

- other configurations are available, consult Dixon® for information

Female Thread	Female NST (NH) Thread	Cast Brass	
		Part #	Price/E
1½" NPT	1½"	FFH1515F	\$26.20
2½" NPT	2½"	FFH2525F	59.75
1½" NST (NH)	1½"	FFH15F15F	26.20
2½" NST (NH)	2½"	FFH25F25F	59.75

Female Thread	Female NYFD	Cast Brass	
		Part #	Price/E
1½" NYFD	1½"	FFH15NYFD15NYFD	\$87.45
1½" NPT	1½"	FFH1515NYFD	87.45
2½" NPT	2½"	FFH2525NYFD	120.00

Female Thread	Female Thread	Cast Brass	
		Part #	Price/E
1½" NPT	1½" NPSH	FFH15T15S	\$62.20



Female Rocker Lug - Suction with Poly Screen

Feature:

- suction intake with strainer screen

Female NST (NH) Thread	Female NPT Thread	Cast Brass	
		Part #	Price/E
2½"	1½"	RSFSA25F15T	\$360.75
	2"	RSFSA25F20T	360.75
	2½"	RSFSA250F	345.50
	3"	RSFSA25F30T	398.55



- All adapters are made to approved Dixon® specifications.
- Replacement washers can be found on page J-99

(Open Snoot) Female Swivel Adapters - Pin Lug

Pipe, Welding & Tube Fittings



Features:

- double female rigid hexagon to swivel connection, rigid end thread is always NPT, hose thread is on swivel end
- finishes: -P polished, -C polished chrome plated
- other configurations are available, consult Dixon® for information

Female Swivel Thread	Female Rigid Thread	Cast Brass	
		Part #	Price/E
1½" NST (NH)	1½" NPT	SF150F	\$91.70
1½" NPSH	1½" NPT	SF150S	118.20
2½" NST (NH)	1½" NPT	SF25F15T	225.30
2½" NST (NH)	2" NPT	SF25F20T	160.30
2½" NYFD	2½" NPT	SF250NYFD	181.30
2½" NST (NH)	2½" NPT	SF250F	107.60
2½" NST (NH)	2½" NPT	SF250F-P	136.00
2½" NST (NH)	2½" NPT	SF250F-C	145.00
2½" NPSH	2½" NPT	SF250S	181.30
2½" NST (NH)	3" NPT	SF25F30T	167.65
3" NST (NH)	3" NPT	SF300F	292.55
3" NYFD	3" NPT	SF300NYFD	185.40
4" NST (NH)	4" NPT	SF400F	643.20

Domestic Female Swivel Adapters - Pin Lug



Feature:

- other configurations are available, consult Dixon® for information

Female NST (NH) Swivel Thread	Female Rigid NPT Thread	Cast Brass	
		Part #	Price/E
1½"	1½"	SF150F-D	\$115.85
2½"	2½"	SF250F-D	178.10
	2"	SF25F20T-D	194.30

(Open Snoot) Female Swivel Adapters - Rocker Lug



Feature:

- other configurations are available, consult Dixon® for information

Female NST (NH) Thread	Female Rigid NPT Thread	Cast Brass	
		Part #	Price/E
1½"	1½"	RSF150F	\$91.70
2½"	1½"	RSF25F15T	262.65
	2"	RSF25F20T	160.30
	2½"	RSF250F	149.25
	3"	RSF25F30T	272.60

- All adapters are made to approved Dixon® specifications.
- Replacement washers can be found on page J-99

Double Female Swivels
Pin Lug

Female NPSH Thread	Female NPSH Thread	Cast Brass	
		Part #	Price/E
1½"	1½"	DFP1515	\$86.25
2½"	2½"	DFP2525	175.10

Female NST (NH) Thread	Female NST (NH) Thread	Cast Brass	
		Part #	Price/E
1½"	1½"	DFP1515F	\$80.90
2½"	2½"	DFP2525F	175.10

Female NST (NH) Thread	Female NPSH Thread	Cast Brass	
		Part #	Price/E
1½"	1½"	DFP15F15S	\$86.25
2½"	2½"	DFP25F25S	175.10

Female NYFD Thread	Female NYFD Thread	Cast Brass	
		Part #	Price/E
1½"	1½"	DFP15NYFD15NYFD	\$147.05
2½"	2½"	DFP25NYFD25NYFD	306.45



Rocker Lug

Female NPSH Thread	Female NPSH Thread	Cast Brass	
		Part #	Price/E
1½"	1½"	DFR1515	\$86.25
2½"	2½"	DFR2525	183.05

Female NST (NH) Thread	Female NST (NH) Thread	Cast Brass	
		Part #	Price/E
1½"	1½"	DFR1515F	\$86.25
2½"	2½"	DFR2525F	183.05



Domestic Double Female Swivels - Pin Lug

Female NST (NH) Thread	Female NST (NH) Thread	Cast Brass	
		Part #	Price/E
1½"	1½"	DFP1515F-D	\$215.00
2½"	2½"	DFP2525F-D	265.00



• Replacement washers can be found on page J-99

Aluminum Swivel Female x Rigid Female Adapters - Rocker Lug Style N53

Pipe, Welding & Tube Fittings



Female NPSH Swivel Thread	Female Rigid NPT Thread	Aluminum Extrusion - Anodized Part #	Price/E
1½"	1½"	N53-15S15T	\$118.10
2"	2"	N53-20S20T	128.90
3"	3"	N53-30S30T	230.90
6"	6"	N53-60S60T	711.00



Female NPSH Swivel Thread	Female Rigid NPSH Thread	Aluminum Extrusion - Anodized Part #	Price/E
1½"	1½"	N53-15S15S	\$100.95



Female NST (NH) Swivel Thread	Female Rigid NPT Thread	Aluminum Extrusion - Anodized Part #	Price/E
1½"	1½"	N53-15F15T	\$100.95
2½"	2"	N53-25F20T	134.15
	2½"	N53-25F25T	136.40
	3"	N53-25F30T	190.05
4"	4"	N53-25F40T	229.50
	4"	N53-40F40T	309.55
4½"	4"	N53-45F40T	331.45
	6"	N53-45F60T	607.70
5"	6"	N53-50F60T	362.40
6"	6"	N53-60F60T	430.15



Female NST (NH) Swivel Thread	Female Rigid NST Thread	Aluminum Extrusion - Anodized Part #	Price/E
1½"	1½"	N53-15F15F	\$143.20
2½"	1½"	N53-25F15F	143.20
	2½"	N53-25F25F	134.15
	6"	N53-25F60F	290.20
4"	4"	N53-40F40F	309.55
6"	4½"	N53-60F45F	438.00

- All adapters are made to approved Dixon® specifications.
- Replacement washers can be found on page J-99

Double Swivel Female Adapters - Rocker Lug
Style N35

Pipe, Welding
& Tube Fittings

Female NPSH Swivel Thread	Female NPSH Swivel Thread	Aluminum Extrusion - Anodized	
		Part #	Price/E
1"	1"	N35-10S10S	\$169.00
1½"	1½"	N35-15S15S	140.00
2½"	2½"	N35-25S25S	167.50
3"	3"	N35-30S30S	312.50



Female NST (NH) Swivel Thread	Female NST (NH) Swivel Thread	Aluminum Extrusion - Anodized	
		Part #	Price/E
1"	1"	N35-10F10F	\$169.00
1½"	1½"	N35-15F15F	169.00
	2½"	N35-15F25F	140.00
2½"	2½"	N35-25F25F	136.35
	4"	N35-40F40F	410.85
4½"	4½"	N35-45F45F	410.85
5"	5"	N35-50F50F	528.20
6"	6"	N35-60F60F	556.00



Female NPSH Swivel Thread	Female NST Swivel Thread	Aluminum Extrusion - Anodized	
		Part #	Price/E
1"	1"	N35-10S10F	\$169.00
	1½"	N35-10S15F	169.00
1½"	1½"	N35-15S15F	140.00
2"	2½"	N35-20S25F	197.65
2½"	2½"	N35-25S25F	167.50



Aluminum Double Female Swivel Adapters - Long Handle
Style N57

Female NST (NH) Thread	Male NST (NH) Thread	Aluminum Extrusion - Anodized	
		Part #	Price/E
4½"	6"	N57-45F60F	\$492.55
5"	5"	N57-50F50F	545.45
	6"	N57-50F60F	545.45
6"	6"	N57-60F60F	545.45



- All adapters are made to approved Dixon® specifications.
- Replacement washers can be found on page J-99

Hydrant Adapters - Pin Lug

Feature:

- other configurations are also available, consult Dixon® for information



reducer



same size



increaser

Female Thread	Male Thread	Cast Brass	
		Part #	Price/E
1½" NPSH	¾" GHT	HA15S76	\$23.70
	¾" NPSH	HA15S75	84.30
	¾" NPT	HA15S75T	84.30
	1" NPSH	HA15S10S	85.85
	1" NPT	HA15S10T	85.85
	1½" NPT	HA15S15T	40.75
	1½" NST (NH)	HA15S15F	40.75
1½" NPT	1½" NPSH	HA15T15S	74.50
	1½" NST (NH)	HA15T15F	40.75
1½" NST (NH)	¾" GHT	HA1576	20.60
	¾" NPSH	HA1575	85.65
	¾" NPT	HA1575T	33.50
	1" NPSH	HA1510	43.25
	1" NST (NH)	HA1510F	40.75
	1" NPT	HA1510T	40.75
	1½" NPSH	HA1515	40.75
	1½" NPT	HA1515T	40.75
	1½" NST (NH)	HA1515F	40.75
	2½" NST (NH)	HA1525F	142.45
2" NPSH	1½" NPSH	HA20S15S	101.35
	1½" NPT	HA20S15T	101.35
	1½" NST (NH)	HA20S15F	36.40
	2½" NST (NH)	HA20S25F	80.10
2" NPT	2½" NST (NH)	HA20T25F	80.10
2" NST (NH)	2½" NST (NH)	HA2025F	132.00
2½" NPSH	1" NPT	HA25S10T	36.40
	1½" NPSH	HA25S15S	115.00
	1½" NPT	HA25S15T	115.00
	1½" NST (NH)	HA25S15F	37.90
	2½" NST (NH)	HA25S25F	72.85
2½" NST (NH)	¾" GHT	HA2576	29.35
	¾" NPT	HA2575T	29.35
	1" NPSH	HA2510	32.35
	1" NST (NH)	HA2510F	32.35
	1" NPT	HA2510T	30.35
	1½" NPSH	HA2515	30.00
	1½" NST (NH)	HA2515F	29.70
	1½" NPT	HA2515T	30.00
	2" NPSH	HA2520	50.95
	2" NST (NH)	HA2520F	50.95
	2" NPT	HA2520T	28.80
	2½" NPSH	HA2525	69.85
	2½" NST (NH)	HA2525F	69.85
	2½" NPT	HA2525T	69.85
3" NPSH	HA2530	108.00	
3" NST (NH)	HA2530F	108.00	
3" NPT	HA2530T	108.00	
3" NPSH	2½" NST (NH)	HA30S25F	82.10
	2½" NPT	HA30S25T	178.10
3" NST (NH)	1½" NPSH	HA3015S	181.00
	1½" NST (NH)	HA3015F	196.20
	2½" NST (NH)	HA3025F	76.40
4" NST (NH)	2½" NST (NH)	HA4025F	145.35
4½" NST (NH)	2½" NST (NH)	HA4525F	218.50

- All adapters are made to approved Dixon® specifications.
- Replacement washers can be found on page J-99

Hydrant Adapters - Rocker Lug

Features:

- finishes: -C polished chrome plated
- other configurations are also available, consult Dixon® for information

Female Thread	Male Thread	Cast Brass	
		Part #	Price/E
1½" NST (NH)	¾" NST (NH)	RHA1576	\$79.90
	1" NST (NH)	RHA1510	46.60
	1" NST (NH)	RHA1510F	46.60
	1" NPT	RHA1510T	46.60
	1½" NPSH	RHA1515	55.80
	1½" NST (NH)	RHA1515F	55.80
	1½" NPT	RHA1515T	55.80
	2" NPSH	RHA1520	113.00
1½" NPSH	2½" NST (NH)	RHA1525F	76.80
	¾" NPT	RHA15S75T	81.85
	1" NPSH	RHA15S10	47.50
	1" NPT	RHA15S10T	49.90
	1½" NST (NH)	RHA15S15F	55.80
1½" NPT	1½" NPT	RHA15S15T	113.00
	1½" NST (NH)	RHA15T15F	55.80
2" NST (NH)	2½" NST (NH)	RHA2025F	132.30
2½" NST (NH)	¾" GHT	RHA2576	36.85
	1" NPSH	RHA2510	49.15
	1" NST (NH)	RHA2510F	49.15
	1" NPT	RHA2510T	49.15
	1½" NPSH	RHA2515	35.50
	1½" NST (NH)	RHA2515F	35.50
	1½" NPT	RHA2515T	75.85
	2" NST (NH)	RHA2520F	144.90
	2" NPT	RHA2520T	51.25
	2½" NPT	RHA2525T	130.00
2½" NPSH	3" NPT	RHA2530T	159.80
	1½" NPSH	RHA25S15	40.25
2½" NPT	1½" NST (NH)	RHA25S15F	40.25
	2½" NST (NH)	RHA25T25F	130.00
3" NST (NH)	2½" NST (NH)	RHA3025F	160.00



reducer



reducer - chrome plated



same size

Pipe, Welding & Tube Fittings

Female x Male Adapters - Long Handle Style N56

Female NST (NH) Thread	Male NST (NH) Thread	Aluminum Extrusion - Anodized	
		Part #	Price/E
4"	2½"	N56-40F25F	\$261.65
4½"	4"	N56-45F40F	315.00
5"	2½"	N56-50F25F	315.00
6"	4½"	N56-60F45F	315.00
	6"	N56-60F60T ¹	315.00



¹ female NST (NH) x male NPT

- All adapters are made to approved Dixon® specifications.
- Replacement washers can be found on page J-99

Hydrant Adapters - Pin Lugs (New York Threads)

Pipe, Welding
& Tube Fittings



reducer



same size



increaser

Features:

- NYFD thread = 3.031 x 8 TPI
- NYC thread = 3.00 x 8 TPI
- other configurations are also available, consult Dixon® for information

Female NYFD Thread	Male Thread	Cast Brass	
		Part #	Price/E
1½"	¾" GHT	HA15NYFD76	\$46.85
	¾" NPT	HA25NYFD75T	107.55
	¾" GHT	HA25NYFD76	34.15
	1½" NPSH	HA25NYFD15S	39.75
	1½" NST (NH)	HA25NYFD15F	39.75
	1½" NPT	HA25NYFD15T	129.15
	1½" NYFD	HA25NYFD15NYFD	39.75
	2" NPT	HA25NYFD20T	35.75
2½"	2½" NST (NH)	HA25NYFD25F	58.90

Female NYC Thread	Male Thread	Cast Brass	
		Part #	Price/E
2½"	¾" GHT	HA25NYC76	\$118.20
	1" NPT	HA25NYC10T	125.85
	1½" NPT	HA25NYC15T	129.15
	2" NPT	HA25NYC20T	35.75

Hazmat Adapters - Pin Lugs



Feature:

- divides single stream into double stream

Female NST Thread	Male Thread	Cast Brass	
		Part #	Price/E
1½"	(2) ¾" GHT	HHA1576	\$47.70
2½"	(2) ¾" GHT	HHA2576	56.45

- All adapters are made to approved Dixon® specifications.
- Replacement washers can be found on page J-99

Domestic Hydrant Adapters - Pin Lug

Feature:

- other configurations are available, consult Dixon® for information

Female NST (NH) Thread	Male Thread	Cast Brass	
		Part #	Price/E
1½"	¾" GHT	HA1576-D	\$68.75
	1" NPT	HA2510T-D	123.00
2½"	1½" NST (NH)	HA2515F-D	109.60
	1½" NPT	HA2515T-D	125.55
	¾" GHT	HA2576-D	135.10



Pipe, Welding & Tube Fittings

Domestic Female to Male Hex Nipples

Feature:

- other configurations are available, consult Dixon® for information

Female Thread	Male Thread	Cast Brass	
		Part #	Price/E
1" NPT	1½" NST (NH)	FM1015F-D	\$71.10
1½" NPT	1½" NST (NH)	FM1515F-D	72.55
	2½" NST (NH)	FM1525F-D	128.00
1½" NST (NH)	1½" NPSH	FM15F15S-D	72.55
	1½" NPT	FM15F15T-D	72.55
	2½" NST (NH)	FM15F25F-D	128.75
1½" NPSH	1½" NST (NH)	FM15S15F-D	72.55
	1½" NPT	FM15S15T-D	72.55
2" NPT	1½" NST (NH)	FM2015F-D	89.25
2½" NPT	2½" NST (NH)	FM2525F-D	126.40
2½" NST (NH)	1½" NST (NH)	FM25F15F-D	128.20
	1½" NPT	FM25F15T-D	128.20
	2½" NPT	FM25F25T-D	126.40



reducer



same size



increaser

Hydrant Adapters - Rocker Lug

Features:

- use with water
- maximum working pressure: **100 PSI at 70°F (21°C)**

Female Thread	Male Thread	Polycarbonate	
		Part #	Price/E
1½" NPSH	1½" NST (NH)	POLYHA15S15F	\$16.35
	¾" GHT	POLYHA2576	19.80
2½" NST (NH)	1½" NPSH	POLYHA2515	23.80
	1½" NST (NH)	POLYHA2515F	23.80
	2" NPT	POLYHA2520T	19.80



- All adapters are made to approved Dixon® specifications.
- Replacement washers can be found on page J-99

Single Male Outlet with Hex (open snoot)

Pipe, Welding & Tube Fittings



polished



polished chrome plated

Application:

- used to connect fire hose to a standpipe or sprinkler system

Features:

- finishes: -P polished, -C polished chrome plated
- other sizes, threads and configurations are available, consult Dixon® for information

Female NPT Thread	Male Thread	Cast Brass	
		Part #	Price/E
2½"	2½" NST (NH)	MOC250F-P	\$149.85
	2½" NST (NH)	MOC250F-C	170.00
3"	2½" NST (NH)	MOC3025F-P	204.55
	2½" NST (NH)	MOC3025F-C	219.70
	3" NST (NH)	MOC300F-P	174.75
Female NPT Thread	Male Thread	Cast Brass	
		Part #	Price/E
2½"	2½" NYC	MOC250NYC-P	\$149.85
	2½" NYFD	MOC250NYFD-P	149.85

Female to Male Hex Nipples

Feature:

- other configurations are also available, consult Dixon® for information

Female Thread	Male Thread	Cast Brass	
		Part #	Price/E
¾" GHT	1" NPT	FM7610T	\$53.35
1" NPSH	¾" GHT	FM10S76	23.40
	¾" GHT	FM1076	20.55
1" NPT	1" NPSH	FM1010	36.60
	1" NST (NH)	FM1010F	33.50
	1½" NPSH	FM1015	69.00
	1½" NST (NH)	FM1015F	41.75
1" NST (NH)	1" NPT	FM10F10T	33.50
1½" NPT	1½" NPSH	FM1515	21.25
	1½" NST (NH)	FM1515F	20.60
	2½" NST (NH)	FM1525F	67.75
1½" NST (NH)	1½" NPSH	FM15F15S	26.05
	1½" NPT	FM15F15T	18.40
	2" NPT	FM15F20T	37.50
	2½" NPT	FM15F25T	64.15
	2½" NST (NH)	FM15F25F	64.15
	1½" NST (NH)	FM15F15F	26.05
1½" NPSH	1½" NST (NH)	FM15S15F	22.85
	1½" NPT	FM15S15T	22.85
	2" NPT	FM15S20T	74.50
2" NPSH	1½" NPSH	FM20S15	64.40
	1½" NST (NH)	FM20S15F	64.40
	1½" NPT	FM20S15T	30.60
	2" NPT	FM20S20T	127.35
	2½" NST (NH)	FM20S25F	91.10
2" NPT	1½" NPSH	FM2015	89.25
	1½" NST (NH)	FM2015F	28.15
	2" NPSH	FM2020	140.00
	2½" NST (NH)	FM2025F	81.40
2½" NST (NH)	¾" NPT	FM25F75T	144.55
	1" NPT	FM25F10T	138.05
	1½" NST (NH)	FM25F15F	80.05
	1½" NPT	FM25F15T	80.05
	2" NPT	FM25F20T	52.05
2½" NPT	1½" NST (NH)	FM2515F	139.00
	2½" NPSH	FM2525	63.15
	2½" NST (NH)	FM2525F	53.75

Table continued on next page

- All adapters are made to approved Dixon® specifications.
- Replacement washers can be found on page J-99



reducer



same size

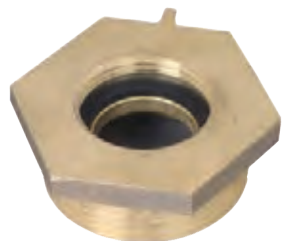

increaser

Female to Male Hex Nipples

Table continued from previous page

Female Thread	Male Thread	Cast Brass	
		Part #	Price/E
2½" NST (NH)	2½" NST (NH)	FM25F25F	\$62.15
	2½" NPT	FM25F25T	53.80
	3" NST (NH)	FM25F30F	89.80
	3" NPT	FM25F30T	89.80
	2½" NPSH	FM25F25S	144.55
2½" NPT	2½" NPT	FM2525T	102.80
2½" NPSH	2½" NST (NH)	FM25S25F	62.15
	2½" NPT	FM25S25T	62.15
3" NPT	2½" NST (NH)	FM3025F	86.05
	2½" NPT	FM3025T	98.85
	3" NST (NH)	FM3030F	144.65
3" NST (NH)	2½" NST (NH)	FM30F25F	98.85
	2½" NPT	FM30F25T	98.85
	3" NPT	FM30F30T	144.65
3" NPSH	2½" NST (NH)	FM30S25F	201.20
4" NPT	2½" NST (NH)	FM4025F	387.30
	4" NST (NH)	FM4040F	366.40
	4½" NST (NH)	FM4045F	273.55
4" NST (NH)	4" NPT	FM40F40T	287.40
4½" NST (NH)	4" NPT	FM45F40T	454.25
6" NPT	6" NST (NH)	FM6060F	618.00
6" NST (NH)	6" NPT	FM60F60T	618.00



reducer



same size



increaser

Pipe, Welding & Tube Fittings

Female to Male Hex Nipples
(New York Threads)

Features:

- NYFD thread = 3.031 x 8 TPI
- NYC thread = 3.00 x 8 TPI
- other configurations are available, consult Dixon® for information

Female Thread	Male Thread	Cast Brass	
		Part #	Price/E
1½" NPT	1½" NYFD	FM1515NYFD	\$32.00
1½" NST (NH)	1½" NYFD	FM15F15NYFD	32.00
1½" NYFD	1½" NST (NH)	FM15NYFD15F	32.00
	1½" NPT	FM15NYFD15T	32.00



reducer



same size



increaser

Female Thread	Male Thread	Cast Brass	
		Part #	Price/E
2½" NPT	2½" NYC	FM2525NYC	\$136.00
	2½" NYFD	FM2525NYFD	65.00
2½" NST (NH)	2½" NYC	FM25F25NYC	136.00
	2½" NYFD	FM25F25NYFD	136.00
2½" NYC	2½" NST (NH)	FM25NYC25F	142.05
	2½" NPT	FM25NYC25T	153.15
2½" NYFD	2½" NST (NH)	FM25NYFD25F	67.30
	2½" NPT	FM25NYFD25T	67.30

Female NYFD Thread	Male Thread	Cast Brass	
		Part #	Price/E
2½"	1½" NPT	FM25NYFD15T	\$120.00
	2" NPT	FM25NYFD20T	83.40
	3" NPT	FM25NYFD30T	142.00

- All adapters are made to approved Dixon® specifications.
- Replacement washers can be found on page J-99

Female x Male Adapters - Rocker Lug
Style N37

Pipe, Welding
& Tube Fittings



reducer



same size



increaser



Female Thread	Male Thread	Aluminum Extrusion - Anodized		
		Part #	Price/E	
3/4" GHT	1" NST (NH)	N37-07G10F	\$75.00	
	1" NPSH	N37-07G10S	86.45	
	1" NPT	N37-07G10T	75.00	
	1 1/2" NST (NH)	N37-07G15F	80.00	
	1 1/2" NPSH	N37-07G15S	80.00	
	1" NST	3/4" GHT	N37-10F07G	75.00
1" NST	1" NPSH	N37-10F10S	75.00	
	1" NPT	N37-10F10T	75.00	
	1 1/2" NST (NH)	N37-10F15F	75.00	
	1 1/2" NPSH	N37-10F15S	75.00	
	2 1/2" NST (NH)	N37-10F25F	80.00	
	1" NPSH	3/4" GHT	N37-10S07G	75.00
1" NPSH	3/4" NPSH	N37-10S07S	75.00	
	1" NST (NH)	N37-10S10F	75.00	
	1" NPT	N37-10S10T	75.00	
	1 1/2" NST (NH)	N37-10S15F	75.00	
	1 1/2" NPSH	N37-10S15S	75.00	
	1" NPT	1" NST	N37-10T10F	75.00
1 1/2" NST (NH)	3/4" GHT	N37-15F07G	80.00	
	3/4" NPT	N37-15F07T	80.00	
	1" NST (NH)	N37-15F10F	80.00	
	1" NPSH	N37-15F10S	80.00	
	1" NPT	N37-15F10T	80.00	
	1 1/2" NST (NH)	N37-15F15F	80.00	
	1 1/2" NPSH	N37-15F15S	80.00	
	1 1/2" NPT	N37-15F15T	80.00	
	2" NPT	N37-15F20T	80.00	
	2 1/2" NST (NH)	N37-15F25F	80.00	
	1 1/2" NPSH	3/4" GHT	N37-15S07G	80.00
		1" NST (NH)	N37-15S10F	127.00
1 1/2" NST (NH)		N37-15S15F	80.00	
1 1/2" NPT		N37-15S15T	80.00	
2" NPT		N37-15S20T	80.00	
1 1/2" NPT		1 1/2" NST (NH)	N37-15T15F	80.00
1 1/2" NPT	1 1/2" NPSH	N37-15T15S	80.00	
	2 1/2" NST (NH)	N37-15T25F	80.00	
	2" NPSH	3/4" GHT	N37-20S07G	90.00
		1 1/2" NST (NH)	N37-20S15F	90.00
		1 1/2" NPSH	N37-20S15S	90.00
		2" NPT	N37-20S20T	90.00
2 1/2" NST (NH)		N37-20S25F	127.00	
2" NPT		1 1/2" NST (NH)	N37-20T15F	90.00
2" NPT	1 1/2" NPSH	N37-20T15S	90.00	
	2 1/2" NST (NH)	N37-20T25F	90.00	

• table continued on next page

- All adapters are made to approved Dixon® specifications.
- Replacement washers can be found on page J-99

Female x Male Adapters - Rocker Lug (continued)
Style N37

Pipe, Welding
& Tube Fittings

Table continued from previous page

Female Thread	Male Thread	Aluminum Extrusion - Anodized	
		Part #	Price/E
2½" NST (NH)	¾" GHT	N37-25F07G	\$92.50
	¾" NPT	N37-25F07T	92.50
	1" NPT	N37-25F10T	92.50
	1½" NST (NH)	N37-25F15F	92.50
	1½" NPSH	N37-25F15S	92.50
	1½" NPT	N37-25F15T	92.50
	2" NPT	N37-25F20T	92.50
	2½" NST (NH)	N37-25F25F	92.50
	2½" NPSH	N37-25F25S	92.50
	2½" NPT	N37-25F25T	92.50
	3" NST (NH)	N37-25F30F	112.50
3" NPT	N37-25F30T	112.50	
2½" NPSH	1½" NPSH	N37-25S15S	92.50
	2½" NST (NH)	N37-25S25F	92.50
	2½" NPT	N37-25S25T	92.50
2½" NPT	1½" NPSH	N37-25T15S	92.50
	2½" NST (NH)	N37-25T25F	92.50
	3" NPT	N37-25T30T	112.50
3" NST (NH)	1½" NST (NH)	N37-30F15F	218.75
	2½" NST (NH)	N37-30F25F	218.75
	3" NPT	N37-30F30T	218.75
	2½" NST (NH)	N37-30S25F	218.75
3" NPT	2½" NST (NH)	N37-30T25F	218.75
	2½" NPT	N37-30T25T	218.75
4" NST (NH)	2½" NST (NH)	N37-40F25F	212.40
	4" NST (NH)	N37-40F40F	212.40
	4" NPT	N37-40F40T	212.40
	6" NST (NH)	N37-40F60F	212.40
4" NPT	2½" NST (NH)	N37-40T25F	212.40
	4" NST (NH)	N37-40T40F	212.40
	4½" NST (NH)	N37-40T45F	212.40
4½" NST (NH)	2½" NST (NH)	N37-45F25F	254.85
	4" NST (NH)	N37-45F40F	236.70
	4" NPT	N37-45F40T	236.70
	5" NST (NH)	N37-45F50F	236.70
5" NST (NH)	4½" NST (NH)	N37-50F45F	285.50
	5" NPT	N37-50F50T	285.50
	6" NST (NH)	N37-50F60F	285.50
5" NPSH	6" NST (NH)	N37-50S60F	305.00
5" NPT	5" NST (NH)	N37-50T50F	285.50
6" NST (NH)	4" NPT	N37-60F40T	315.00
	5" NST (NH)	N37-60F50F	315.00
	6" NPT	N37-60F60T	290.20
6" NPT	4" NST (NH)	N37-60T40F	270.00
	6" NST (NH)	N37-60T60F	315.00



- All adapters are made to approved Dixon® specifications.
- Replacement washers can be found on page J-99

Brass Female Swivel to Male Adapters

Pin Lug



Female NST (NH) Thread	Male NPT Thread	Cast Brass	
		Part #	Price/E
1½"	1½"	SM150F	\$74.30
2½"	1½"	SM25F15T	159.40
	2"	SM25F20T	150.40
	2½"	SM250F	94.15
	3"	SM25F30T	179.55
4"	4"	SM400F	574.25

Female NPSH Thread	Male NPT Thread	Cast Brass	
		Part #	Price/E
1½"	1½"	SM150S	\$93.30
2"	2"	SM200S	141.60
2½"	2½"	SM250S	185.40

Female Thread	Male NST (NH) Thread	Cast Brass	
		Part #	Price/E
1½" NPSH	1½"	SM15S15F	\$166.10
2½" NST (NH)	3"	SM25F30F	271.10

Female Thread	Male NPT Thread	Cast Brass	
		Part #	Price/E
1½" NYFD	1½"	SM150NYFD	\$130.85
2½" NYFD	2½"	SM250NYFD	195.00

Rocker Lug



Female Thread	Male NPT Thread	Cast Brass	
		Part #	Price/E
1½" NST (NH)	1½"	RSM150F	\$93.30
1½" NPSH	1½"	RSM150S	90.70
2½" NST (NH)	2"	RSM25F20T	150.40
	2½"	RSM250F	108.15
	3"	RSM25F30T	179.55

Domestic Male Swivel Adapters - Pin Lug



Female NST (NH) Swivel Thread	Male NPT Thread	Cast Brass	
		Part #	Price/E
1½"	1½"	SM150F-D	\$108.35
2½"	2½"	SM250F-D	185.40
	2"	SM25F20T-D	195.75
	3"	SM25F30T-D	350.20

- All adapters are made to approved Dixon® specifications.
- Replacement washers can be found on page J-99

Male Rocker Lug - Suction with Poly Screen

Feature:

- suction intake with strainer screen

Female NST (NH) Thread	Male NPT Thread	Cast Brass	
		Part #	Price/E
2½"	2"	RSMSA25F20T	\$337.20
	2½"	RSMSA250F	340.80
	3"	RSMSA25F30T	382.60



Pipe, Welding & Tube Fittings

Male Rocker Lug - Suction with Zinc Screen

Feature:

- suction intake with zinc strainer screen - excellent to use before backflow preventers

Female NST (NH) Thread	Male NPT Thread	Cast Brass	
		Part #	Price/E
2½"	2"	RSMSA25F20T-Z	\$374.85
	2½"	RSMSA250F-Z	378.95
	3"	RSMSA25F30T-Z	425.35



Male Rocker Lug - Suction with Poly Screen

Feature:

- suction intake with strainer screen

Female NST (NH) Thread	Male NPT Thread	Aluminum	
		Part #	Price/E
2½"	2"	ARSMSA25F20T	\$222.95
	2½"	ARSMSA250F	218.00



- All adapters are made to approved Dixon® specifications.
- Replacement washers can be found on page J-99



Female Swivel to Male Adapters - Rocker Lug
Style N54

Pipe, Welding
& Tube Fittings



Female Swivel Thread	Male Rigid Thread	Aluminum Extrusion - Anodized	
		Part #	Price/E
1½" NST (NH)	1½" NST (NH)	N54-15F15F	\$112.45
	1½" NPT	N54-15F15T	145.20
	2½" NST (NH)	N54-15F25F	115.95
1½" NPSH	1½" NPSH	N54-15S15S	121.35
	1½" NPT	N54-15S15T	146.35
2½" NST (NH)	1½" NST (NH)	N54-25F15F	152.35
	1½" NPT	N54-25F15T	155.70
	2" NPT	N54-25F20T	163.40
	2½" NST (NH)	N54-25F25F	123.20
	2½" NPT	N54-25F25T	133.95
	3" NPT	N54-25F30T	137.30
2½" NPSH	2" NPT	N54-25S20T	178.15
3" NPSH	3" NPT	N54-30S30T	214.80
4" NST (NH)	4" NST (NH)	N54-40F40F	228.10
	4" NPT	N54-40F40T	308.85
	6" NST (NH)	N54-40F60F	394.00
4½" NST (NH)	4" NPT	N54-45F40T	321.25
	6" NPT	N54-45F60T	343.00
6" NST (NH)	6" NPT	N54-60F60T	454.60

Female Swivel to Male Adapters - Long Handle
Style N54L



Female NST Thread	Male Thread	Aluminum Extrusion - Anodized	
		Part #	Price/E
2½"	2½" NST (NH)	N54L-25F25F	\$156.45
4"	6" NST (NH)	N54L-40F60F	475.95
4½"	4" NPT	N54L-45F40T	349.00
6"	4" NPT	N54L-60F40T	443.00
	5" NST (NH)	N54L-60F50F	451.20
	6" NPT	N54L-60F60T	466.80

- All adapters are made to approved Dixon® specifications.
- Replacement washers can be found on page J-99

Double Male Hex Nipples

Feature:

- other configurations are available, consult Dixon® for information

Male Thread	Male Thread	Cast Brass	
		Part #	Price/E
3/4" NPT	1 1/2" NPSH	DMH7515	\$61.25
	1 1/2" NST (NH)	DMH7515F	66.55
1" NPT	3/4" GHT	DMH1076	13.15
	1" NPSH	DMH1010	12.50
	1" NST (NH)	DMH1010F	12.50
	1" NPT	DMH1010T	95.30
	1 1/2" NPSH	DMH1015	69.65
	1 1/2" NST (NH)	DMH1015F	69.65
	2 1/2" NST (NH)	DMH1025F	161.80
1 1/2" NPSH	1 1/2" NPSH	DMH15S15S	81.50
1 1/2" NPT	1" NPSH	DMH1510	75.25
	1" NST (NH)	DMH1510F	75.25
	1 1/2" NPSH	DMH1515	20.70
	1 1/2" NPT	DMH1515T	37.30
	1 1/2" NST (NH)	DMH1515F	18.95
	2" NPSH	DMH1520	61.15
	2 1/2" NST (NH)	DMH1525F	63.00
1 1/2" NST (NH)	1 1/2" NPSH	DMH15F15S	23.15
	1 1/2" NST (NH)	DMH15F15F	23.15
	2 1/2" NST (NH)	DMH15F25F	63.00
2" NPT	1 1/2" NPSH	DMH2015	46.00
	1 1/2" NST (NH)	DMH2015F	39.30
	2" NPSH	DMH2020	43.35
	2 1/2" NPSH	DMH2025	63.25
	2" NPT	DMH2020T	123.05
	2 1/2" NST (NH)	DMH2025F	50.60
2 1/2" NPT	1 1/2" NPSH	DMH2515	168.40
	1 1/2" NST (NH)	DMH2515F	85.25
	2" NPSH	DMH2520	113.00
	2 1/2" NPSH	DMH2525	54.15
	2 1/2" NST (NH)	DMH2525F	53.60
	2 1/2" NPT	DMH2525T	118.20
	3" NPSH	DMH2530	208.95
	3" NPT	DMH2530T	215.00
	3" NST (NH)	DMH2530F	208.95
2 1/2" NST (NH)	2 1/2" NST (NH)	DMH25F25F	52.40
	3" NST (NH)	DMH25F30F	215.00
3" NPT	2 1/2" NPSH	DMH3025	105.00
	2 1/2" NST (NH)	DMH3025F	99.00
	3" NPSH	DMH3030	144.00
	3" NST (NH)	DMH3030F	144.00
	3" NPT	DMH3030T	170.25
4" NPT	4" NPSH	DMH4040	231.00
4" NST (NH)	4" NST	DMH40F40F	313.90
4" NPT	4" NST (NH)	DMH4040F	219.00
	4 1/2" NST (NH)	DMH4045F	235.45
	4" NPT	DMH4040T	332.45
5" NPT	5" NST (NH)	DMH5050F	590.00
6" NPT	4 1/2" NST (NH)	DMH6045F	447.00
	6" NST (NH)	DMH6060F	482.00
	6" NPSH	DMH6060	994.00
	6" NPT	DMH6060T	589.25



reducer



same size



increaser

- All adapters are made to approved Dixon® specifications.

Double Male Hex Adapters (NYFD Threads)

Pipe, Welding
& Tube Fittings



reducer



same size



increaser

Feature:

- other configurations are available, consult Dixon® for information

Male Thread	Male NYFD Thread	Cast Brass	
		Part #	Price/E
1½" NPT	1½"	DMH1515NYFD	\$26.15
1½" NST (NH)	1½"	DMH15F15NYFD	57.30
1½" NPT	2½"	DMH1525NYFD	124.10
2" NPT	2½"	DMH2025NYFD	111.20
2½" NPT	1½"	DMH2515NYFD	137.50
2½" NPT	2½"	DMH2525NYFD	53.60

Male NYFD Thread	Male NPT Thread	Cast Brass	
		Part #	Price/E
2½"	2"	DMH2025NYFD	\$111.20

Male NST (NH) Thread	Male NYFD Thread	Cast Brass	
		Part #	Price/E
2½"	2½"	DMH25F25NYFD	\$118.00

Male NYFD Thread	Male NYFD Thread	Cast Brass	
		Part #	Price/E
1½"	1½"	DMH15NYFD15NYFD	\$81.50
2½"	2½"	DMH25NYFD25NYFD	118.00

- NYFD thread: 3.031 x 8 TPI

- All adapters are made to approved Dixon® specifications.

Domestic Double Male Hex Adapters

Feature:

- other configurations are available, consult Dixon® for information

Male Thread	Male Thread	Cast Brass	
		Part #	Price/E
1" NPT	1" NST (NH)	DMH1010F-D	\$54.30
	1½" NST (NH)	DMH1015F-D	69.65
1½" NPT	1½" NPSH	DMH1515-D	74.10
	1½" NST (NH)	DMH1515F-D	74.10
	2½" NST (NH)	DMH1525F-D	134.75
1½" NST (NH)	1½" NST (NH)	DMH15F15F-D	77.35
	1½" NPSH	DMH15F15S-D	78.95
	2½" NST (NH)	DMH15F25F-D	149.85
2" NPT	1½" NST (NH)	DMH2015F-D	59.85
	2" NPSH	DMH2020-D	85.00
	2½" NST (NH)	DMH2025F-D	110.75
2½" NPT	1½" NST (NH)	DMH2515F-D	145.85
	2½" NST (NH)	DMH2525F-D	145.85
2½" NST (NH)	2½" NST (NH)	DMH25F25F-D	145.85
3" NPT	2½" NST (NH)	DMH3025F-D	237.90
	3" NST (NH)	DMH3030F-D	243.20
4" NPT	4½" NST (NH)	DMH4045F-D	435.00
6" NPT	6" NST (NH)	DMH6060F-D	994.00

- All adapters are made to approved Dixon® specifications.



reducer



same size



increaser

Pipe, Welding
& Tube Fittings

Double Male Adapters

Feature:

- other configurations are available, consult Dixon® for information

Pin Lug

Male Thread	Male Thread	Cast Brass	
		Part #	Price/E
1½" NST (NH)	1½" NST (NH)	DMP1515F	\$88.05
	1½" NPT	DMP15F15T	88.05
1½" NPSH	1½" NPSH	DMP1515	88.05
	1½" NPT	DMP15S15T	88.05
1½" NST (NH)	1½" NPSH	DMP15F15S	88.05
2½" NST (NH)	2½" NST (NH)	DMP2525F	159.60
	2½" NPSH	DMP25F25S	159.60
	2½" NPT	DMP25F25T	159.60
2½" NPSH	2½" NPSH	DMP2525	159.60



Rocker Lug

Male Thread	Male Thread	Cast Brass	
		Part #	Price/E
1½" NST (NH)	1½" NST (NH)	DMR1515F	\$65.40
	1½" NPT	DMR15F15T	65.40
	1½" NPSH	DMR15F15S	65.40
1½" NPSH	1½" NPSH	DMR1515	65.40
	1½" NPT	DMR15S15T	65.40
2½" NST (NH)	2½" NST (NH)	DMR2525F	168.00
2½" NPSH	2½" NPSH	DMR2525	168.00



Double Male Adapters - Rocker Lug
Style N36

Pipe, Welding
& Tube Fittings



same size



increaser

Male NST (NH) Thread	Male Thread	Aluminum Extrusion - Anodized	
		Part #	Price/E
1"	1" NST (NH)	N36-10F10F	\$60.95
1½"	1½" NST (NH)	N36-15F15F	60.95
	2" NPT	N36-15F20T	73.35
	2½" NST (NH)	N36-15F25F	73.35
2½"	2½" NST (NH)	N36-25F25F	73.35
	3" NST (NH)	N36-25F30F	105.45
	3" NPT	N36-25F30T	105.45
	4" NST (NH)	N36-25F40F	189.95
	4" NPT	N36-25F40T	189.95
	4½" NST (NH)	N36-25F45F	189.95
3"	3" NST (NH)	N36-30F30F	129.85
4"	4" NST (NH)	N36-40F40F	189.95
4½"	4½" NST (NH)	N36-45F45F	189.95
6"	6" NST (NH)	N36-60F60F	234.55

Male NPT Thread	Male Thread	Aluminum Extrusion - Anodized	
		Part #	Price/E
1½"	1½" NST (NH)	N36-15T15F	\$60.95
	2½" NST (NH)	N36-15T25F	93.75
2"	2" NPT	N36-20T20T	70.15
	2½" NST (NH)	N36-20T25F	103.75
2½"	2½" NST (NH)	N36-25T25F	93.75
	3" NPT	N36-25T30T	93.75
	4" NPT	N36-25T40T	212.85
3"	3" NST (NH)	N36-30T30F	103.75
4"	4" NST (NH)	N36-40T40F	204.35
	4½" NST (NH)	N36-40T45F	204.35
5"	6" NPT	N36-50T60T	277.50
6"	6" NST (NH)	N36-60T60F	277.50

Male NPSH Thread	Male Thread	Aluminum Extrusion - Anodized	
		Part #	Price/E
1"	1" NPSH	N36-10S10S	\$66.20
1½"	1½" NST (NH)	N36-15S15F	66.20
	1½" NPSH	N36-15S15S	66.20
	1½" NPT	N36-15S15T	66.20
	2" NPSH	N36-15S20S	66.20
2½"	2½" NST (NH)	N36-25S25F	86.20
	2½" NPSH	N36-25S25S	86.20

• All adapters are made to approved Dixon® specifications.

Cam and Groove Hydrant Adapters

Features:

- pin lugs allow for easy connection using standard spanner and hydrant wrenches on pages J-113 to J-116
- supplied with a Buna-N washer in the threaded end



Pipe, Welding
& Tube Fittings

FemaleNST (NH) Thread	Male Adapter	Brass		Aluminum	
		Part #	Price/E	Part #	Price/E
1½"	1½"	HA1515ADP	\$75.50	AHA1515ADP	\$56.05
2½"	2½"	HA2525ADP	83.30	AHA2525ADP	52.50

Replacement Washers

ID	OD	Thickness	Buna-N	
			Part #	Price/E
1-9/16"	2-1/16"	1/8"	SW150	\$2.00
2-9/16"	3-3/16"	3/16"	SW250	3.25



- All adapters are made to approved Dixon® specifications.



Brass Caps

Pin Lug

Features:

- finishes: -P polished, -C polished chrome plated
- NOT intended for pressure applications - for debris and thread protection only 



NST (NH) Thread	Cast Brass	
	Part #	Price/E
1½"	<i>FC150F</i>	\$21.40
	<i>FC150F-P</i>	28.15
	<i>FC150F-C</i>	32.50
2"	<i>FC200F</i>	75.50
	<i>FC250F</i>	32.00
2½"	<i>FC250F-P</i>	38.40
	<i>FC250F-C</i>	40.70
	<i>FC300F</i>	153.50
4"	<i>FC400F</i>	201.35
	<i>FC450F</i>	201.35
6"	<i>FC600F</i>	308.25

NPSH Thread	Cast Brass	
	Part #	Price/E
1½"	<i>FC150</i>	\$24.45
2"	<i>FC200</i>	55.50
2½"	<i>FC250</i>	43.70
3"	<i>FC300</i>	153.50
4"	<i>FC400</i>	249.40
6"	<i>FC600</i>	308.25

Rocker Lug

Feature:

- finishes: -P polished, -C polished chrome plated



NST (NH) Thread	Cast Brass	
	Part #	Price/E
1"	<i>RFC100F</i>	\$55.20
1½"	<i>RFC150F</i>	25.15
2½"	<i>RFC250F</i>	33.40
	<i>RFC250F-C</i>	68.70

NPSH Thread	Cast Brass	
	Part #	Price/E
¾"	<i>RFC075</i>	\$46.15
1"	<i>RFC100</i>	57.10
1½"	<i>RFC150</i>	28.80
2"	<i>RFC200</i>	85.80
2½"	<i>RFC250</i>	112.30

Brass Test Caps

Features:

- pet cock port supplied with ⅛" NPT
- drain cock port supplied with ¼" NPT



NST (NH) Thread	Brass	
	Part #	Price/E
2½"	<i>NST250TC</i>	\$275.80

Aluminum Caps with Cable

Rocker Lug

Features:

- other configurations are available, consult Dixon® for information, not all configurations are stocked
- aircraft cable (coated) included

Size	Thread	Extruded Hardcoated Aluminum	
		Part #	Price/E
1"	NST (NH)	CAP100F-C	\$65.80
1½"		CAP150F-C	57.60
2"		CAP200F-C	66.70
2½"		CAP250F-C	84.00
3"		CAP300F-C	146.65
4"		CAP400F-C	262.85
4½"		CAP450F-C	269.70
5"		CAP500F-C	345.85
6"	CAP600F-C	365.85	
1"	NPSH	CAP100S-C	65.80
1½"		CAP150S-C	57.60
2"		CAP200S-C	66.70
2½"		CAP250S-C	84.00



Pipe, Welding & Tube Fittings

Long Handle

NST (NH) Thread	Extruded Hardcoated Aluminum	
	Part #	Price/E
4"	CAP400F-C-LH	\$313.10
4½"	CAP450F-C-LH	310.00
5"	CAP500F-C-LH	386.75
6"	CAP600F-C-LH	453.65



Aluminum Test Caps

Feature:

- supplied with ¼" NPT drill and tap

Size	Thread	Aluminum	
		Part #	Price/E
1½"	NST (NH)	CAP150FABS	\$64.75
2"		CAP200FABS	137.85
2½"		CAP250FABS	106.10
3"		CAP300FABS	112.25
4"		CAP400FABS	267.05
4½"		CAP450FABS	314.85
5"		CAP500FABS	320.30
6"		CAP600FABS	279.00
1½"	NPSH	CAP150SABS	64.75
2"		CAP200SABS	137.85
2½"		CAP250SABS	106.10
3"		CAP300SABS	112.25
4"		CAP400SABS	267.05
4½"		CAP450SABS	314.85
5"		CAP500SABS	169.05
6"		CAP600SABS	599.50



Thermoplastic Caps

Caps with Chain

Pipe, Welding & Tube Fittings



Application:

- prevents entry of foreign material and protects male outlet threads on valves and hydrants

Feature:

- NOT intended to be pressurized 

Size	Thread	Polycarbonate	
		Part #	Price/E
1½"	NPSH	PFCW150	\$15.10
	NST (NH)	PFCW150F	15.10
2"	NPSH	PFCW200	23.20
2½"	NST (NH)	PFCW250F	15.95
3"	NST	PFCW300F	30.30

Pressurizable Caps with Chains



Feature:

- can be pressurized to **300 PSI**

Size	Thread	Polycarbonate	
		Part #	Price/E
2½"	NST (NH) Thread	PFC250F	\$39.40

Hydrant Caps

Features:

- 1⅝" pentagonal nut with weep hole
- with chain
- gasket not included



NST (NH) Thread	Polycarbonate	
	Part #	Price/E
4½"	PFCW450F-Y	\$45.25

Features:

- 1⅝" pentagonal nut with weep hole
- gasket not included



NST (NH) Thread	Polycarbonate	
	Part #	Price/E
2½"	PFCW250F-Y	\$12.30
4"	PFCW400F-Y	16.70

Universal Hose Cap

Features:

- universal push on - pull off cap protects all threads by gripping the valve or outlet on the inside of the waterway
- NOT intended to be pressurized 



Size	Polycarbonate	
	Part #	Price/E
2½"	PFC250U	\$19.00

Breakable Caps

Polycarbonate

Application:

- prevents entry of foreign material and protects female threads on pin lug fire department inlet connections

Feature:

- used on pin lug females



Size	Polycarbonate	
	Part #	Price/E
2½"	PBC250	\$8.00

Aluminum

Features:

- for use on fire department inlet connections
- prevents entry of foreign matter and protects female threads
- breakable ears feature permits fast hose connection
- two eyebolts with nuts for attachment to female pin lug swivel
- painted red finish



Size	Aluminum	
	Part #	Price/E
2½"	ABC250	\$10.90

Specialty Caps

Domestic Caps - Pin Lug

Feature:

- other sizes, threads, and finishes available, call Dixon® for information

Size	Thread	Brass	
		Part #	Price/E
1½"	NST (NH)	FC150F-D	\$67.45
2½"		FC250F-D	88.65



Note: jack chains with S-hooks can be found on page D-52

Hydrant Caps

Features:

- pentagon fire hydrant cap
- supplied with chain and ring

Size	Thread	Iron	
		Part #	Price/E
2½"	NST (NH)	IHC250F	\$56.70
4½"	NST (NH)	IHC450F	84.20



Note: jack chains with S-hooks can be found on page D-52

Specialty Caps

Plugs with Cable - Rocker Lug

Feature:

- -NC: no cable option available

Pipe, Welding & Tube Fittings



Size	Extruded Hardcoated Aluminum			
	NST (NH) Part #	Price/E	NPSH Part #	Price/E
1½"	PLUG150F-C	\$67.85	PLUG150S-C	\$67.85
2½"	PLUG250F-C	104.80	PLUG250S-C	104.80
3"	PLUG300F-C	112.95	PLUG300S-C	112.95
4"	PLUG400F-C	148.50	---	---
4½"	PLUG450F-C	241.20	---	---
5"	PLUG500F-C	257.70	---	---
6"	PLUG600F-C	331.30	---	---

Cap Test Gauges

Application:

Used for testing hose or static pressure on hydrants or trucks



Features:

- rocker lug swivel
- petcock to release pressure
- supplied with a 0-300 PSI glycerine 3½" diameter gauge

NST (NH) Thread	Hardcoated Aluminum	
	Part #	Price/E
1½"	AFC150F-TGWP	\$385.15
2½"	AFC250F-TGWP	422.40

FDC Plug

Features:

- fits standard 2½" NST (NH) female swivel
- withstands wide range of temperatures from **-4°F to 200°F (-20°C to 93°C)**
- 1⅛" pentagonal nut with weep hole to allow for drainage
- removed from FDC with adjustable hydrant wrench



NST (NH) Thread	Polycarbonate	
	Part #	Price/E
2½"	PP250F	\$12.00

Adjust-A-Plug

Features:

- molded red polycarbonate protective plug for swivel connections up to 2½"
- two adjustable metal plates installed in the back of the plug can be mated with your local thread
- plug can be easily removed with a fire department spanner wrench



front



back

Polycarbonate	
Part #	Price/E
PAP250	\$8.00

Brass Plugs

Pin Lug

Features:

- finishes: -P polished, -C polished chrome plated
- NOT intended for pressure applications - for debris and thread protection only 

NST (NH) Thread	Cast Brass	
	Part #	Price/E
1½"	FP150F	\$40.10
	FP150F-P	50.75
	FP150F-C	53.30
2½"	FP250F	55.40
	FP250F-P	68.60
	FP250F-C	71.25
3"	FP300F	95.10
4"	FP400F	175.10
4½"	FP450F	420.25

NPSH Thread	Cast Brass	
	Part #	Price/E
1½"	FP150	\$40.10
2½"	FP250	55.40



Pipe, Welding
& Tube Fittings

Rocker Lug

Feature:

- finishes: -P polished, -C polished chrome plated

NST (NH) Thread	Cast Brass	
	Part #	Price/E
1½"	RFP150F	\$82.55
2½"	RFP250F	126.35



Domestic Plugs - Pin Lug

NST (NH) Thread	Brass	
	Part #	Price/E
1½"	FP150F-D	\$67.10
2½"	FP250F-D	122.00



Brass Replacement Swivels and Accessories

Pipe, Welding & Tube Fittings



Features:

- replacement brass swivels for Dixon® fire department connections
- swivel comes with gasket, set screw and ball bearings needed to install on FDC
- other configurations are available, contact Dixon® for information

Size	Female Thread	Brass	
		Part #	Price/E
2½"	NPSH (2.84x8)	PSNP250S	\$103.25
	NST (NH) (3.07x7.5)	PSNP250NST	103.25
	NYC/BA (3.00x8)	PSNP250NYC	103.25
	NYFD (3.03x8)	PSNP250NYFD	103.25
3"	NST (NH)	PSNP300NST	132.10
	NYFD	PSNP300NYFD	132.10

- 2½" requires 50 ball bearings, 3" requires 58 ball bearings

Replacement Parts

Description	Part #	Price/E
2½" gasket	SW250	\$3.25
3" gasket	SW300F	6.85
ball bearings	4600300001	0.35
set screw	4601100418	2.15

Features:

- for use wherever a non-valved, locking coupling is required
- anodized components per MIL-A-8625 Type III Class 1
- Buna-N gaskets
- working pressure: **150 PSI at 70°F (21°C)**
- cast aluminum lock lever assembly on 4", 5" and 6"

FSA-Storz x Rigid Female

Storz x NST (NH) Female

Storz Size	NST (NH) Female Thread	6061-T6 Forged Alumium	
		Part #	Price/E
1½"	1½"	FSA1515F	\$98.80
2"	1½"	FSA2015F	161.70
	2½"	FSA2025F	137.95
2½"	2½"	FSA2525F	148.50
3"	2½"	FSA3025F	168.75
	2½"	FSA4025F	283.75
	3"	FSA4030F	278.10
	4"	FSA4040F	316.00
	4½"	FSA4045F	336.65
	5"	FSA4050F	367.25
4"	6"	FSA4060F	389.90
	2½"	FSA5025F	412.40
	3"	FSA5030F	412.40
	4"	FSA5040F	412.40
	4½"	FSA5045F	430.95
5"	5"	FSA5050F	441.00
	6"	FSA5060F	452.50
	6"	FSA6060F	581.35



Storz x NPT Female

Storz Size	NPT Female Thread	6061-T6 Forged Alumium	
		Part #	Price/E
1½"	1"	FSA1510T	\$98.80
	1½"	FSA1515T	98.80
2"	1½"	FSA2015T	161.70
	2"	FSA2020T	161.70
2½"	1½"	FSA2515T	137.95
	2"	FSA2520T	156.45
	2½"	FSA2525T	148.50
	3"	FSA2530T	170.65
3"	3"	FSA3030T	269.85
	3"	FSA4030T	317.80
	4"	FSA4040T	344.95
4"	6"	FSA4060T	389.90
	3"	FSA5030T	412.40
	4"	FSA5040T	412.40
5"	5"	FSA5050T	441.00
	6"	FSA5060T	452.50
	6"	FSA6040T	554.40
6"	6"	FSA6060T	617.80



Storz x NPSH Female

Storz Size	NPSH Female Thread	6061-T6 Forged Alumium	
		Part #	Price/E
1½"	1½"	FSA1515S	\$98.80
2"	1½"	FSA2015S	161.70
2½"	2½"	FSA2525S	148.50
4"	4"	FSA4040S	344.95



- Replacement washers can be found on page J-112

SFSA - Storz x Swivel Female Adapter - Rocker Lug / Long Handle

Pipe, Welding & Tube Fittings

Features:

- anodized components per MIL-A-8625 Type III Class 1
- Buna-N gaskets
- working pressure: **150 PSI at 70°F (21°C)**
- cast aluminum lock lever assembly on 4", 5" and 6"

Storz x NST (NH) Female Swivel

Storz Size	NST (NH) Female Swivel Thread	6061-T6 Forged Alumium	
		Part #	Price/E
2½"	2½"	SFSA2525F	\$194.25
3"	2½"	SFSA3025F	211.95
4"	2½"	SFSA4025F	360.60
	3"	SFSA4030F	407.25
	4"	SFSA4040F	412.65
	4½"	SFSA4045F	458.20
5"	6"	SFSA4060F	573.35
	2½"	SFSA5025F	518.45
	4"	SFSA5040F	526.95
6"	4½"	SFSA5045F	531.70
	6"	SFSA5060F	620.95
6"	6"	SFSA6060F	664.40



Storz x NPSH Female

Storz Size	NPSH Female Swivel Thread	6061-T6 Forged Alumium	
		Part #	Price/E
2½"	2½"	SFSA2525S	\$199.20
3"	3"	SFSA3030S	231.95
4"	4"	SFSA4040S	412.65
5"	6"	SFSA5060S	620.95



Storz x NST (NH) Female Swivel - Long Handle

Storz Size	NST (NH) Female Swivel Thread	6061-T6 Forged Alumium	
		Part #	Price/E
4"	4½"	SFSA4045F-LH	\$486.85
5"	4"	SFSA5040F-LH	562.45
5"	4½"	SFSA5045F-LH	543.85
6"	6"	SFSA6060F-LH	681.55



- All adapters are made to approved Dixon® specifications.
- Replacement washers can be found on page J-112

MSA - Storz x Rigid Male

Storz x NST (NH) Male

Storz Size	NST (NH) Male Thread	6061-T6 Forged Alumium	
		Part #	Price/E
1½"	1½"	MSA1515F	\$95.10
2"	1½"	MSA2015F	115.85
2½"	2½"	MSA2525F	166.80
3"	2½"	MSA3025F	191.20
4"	2½"	MSA4025F	261.35
	4"	MSA4040F	287.30
	4½"	MSA4045F	355.80
5"	2½"	MSA5025F	355.80
	5"	MSA5050F	418.10



Pipe, Welding
& Tube Fittings

Storz x NPT Male

Storz Size	NPT Male Thread	6061-T6 Forged Alumium	
		Part #	Price/E
1½"	1½"	MSA1515T	\$109.50
2"	1½"	MSA2015T	115.85
2½"	2"	MSA2520T	142.25
	2½"	MSA2525T	166.80
	3"	MSA2530T	191.20
3"	3"	MSA3030T	191.20
4"	4½"	MSA4025T	261.35
	4"	MSA4040T	287.30
5"	4"	MSA5040T	372.70
6"	6"	MSA6060T	500.65



Storz x NPSH Male

Storz Size	NPSH Male Thread	6061-T6 Forged Alumium	
		Part #	Price/E
1½"	1½"	MSA1515S	\$100.60
2"	1½"	MSA2015S	115.85



1½" x 1½"



SFSA30 - Storz x Female Swivel 30° Elbow - Rocker Lug

Pipe, Welding & Tube Fittings



Features:

- anodized components per MIL-A-8625 Type III Class 1
- Buna-N gaskets
- working pressure: **150 PSI at 70°F (21°C)**
- cast aluminum lock lever assembly on 4", 5" and 6"
- screens available for 4" and 5" heads, consult Dixon® for information

Storz Size	NST (NH) Female Swivel Thread	6061-T6 Forged Alumium	
		Part #	Price/E
4"	4"	SFSA30-4040F	\$412.40
	5"	SFSA30-4050F	704.50
	6"	SFSA30-4060F	725.25
5"	3"	SFSA30-5030F	725.40
	4"	SFSA30-5040F	2617.40
	4½"	SFSA30-5045F	2699.00
	6"	SFSA30-5060F	3046.55

- Replacement washers can be found on page J-112

SFSA30 - Storz x Female Swivel 30° Elbow - Long Handle



Features:

- anodized components per MIL-A-8625 Type III Class 1
- Buna-N gaskets
- working pressure: **150 PSI at 70°F (21°C)**
- cast aluminum lock lever assembly on 4", 5" and 6"

Storz Size	NST (NH) Female Swivel Thread	6061-T6 Forged Alumium	
		Part #	Price/E
4"	4½"	SFSA30-4045F-LH	\$458.20
	5"	SFSA30-4050F-LH	738.85
	6"	SFSA30-4060F-LH	761.75

- Replacement washers can be found on page J-112

NCS-CSF - 150 lbs. Carbon Steel Flange x Storz



150# Flange	Storz	Carbon Steel	
		Part #	Price/E
4"	5"	NCS-CSF-STZ450	\$559.95
	6"	NCS-CSF-STZ460	735.55
5"	4"	NCS-CSF-STZ540	559.95
	5"	NCS-CSF-STZ550	605.75
	6"	NCS-CSF-STZ560	781.40
6"	4"	NCS-CSF-STZ640	389.95
	5"	NCS-CSF-STZ650	495.00
	6"	NCS-CSF-STZ660	588.90

- For flange dimensions, diagrams and additional information please reference dixonvalve.com.

NCS-CSF - 150 lbs. Carbon Steel Flange x Storz with Cap



150# Flange	Storz	Carbon Steel	
		Part #	Price/E
5"	6"	NCS-CSF-STZ650C	\$709.30
6"	6"	NCS-CSF-STZ660C	931.65

- For flange dimensions, diagrams and additional information please reference dixonvalve.com.

SSA - Storz x Storz Adapter

Features:

- anodized components per MIL-A-8625 Type III Class 1
- Buna-N gaskets
- working pressure: **150 PSI at 70°F (21°C)**
- cast aluminum lock lever assembly on 4", 5" and 6"

Storz Size	Storz Size	6061-T6 Forged Alumium	
		Part #	Price/E
1½"	2"	SSA1520	\$192.65
	2½"	SSA1525	281.10
2"	2½"	SSA2025	238.55
	3"	SSA2030	186.50
	4"	SSA2540	566.95
4"	5"	SSA4050	649.50
	6"	SSA4060	899.60
5"	6"	SSA5060	940.60



Pipe, Welding
& Tube Fittings

SSA30 - Storz x Storz 30° Elbow Adapters

Features:

- anodized components per MIL-A-8625 Type III Class 1
- Buna-N gaskets
- working pressure: **150 PSI at 70°F (21°C)**
- cast aluminum lock lever assembly on 4", 5" and 6"

Storz Size	Storz Size	6061-T6 Forged Alumium	
		Part #	Price/E
5"	5"	SSA30-550	\$812.75



Accessories

Pipe, Welding & Tube Fittings



Threaded Storz Mounting Plates (Bracket)

Storz Size	Anodized Aluminum	
	Part #	Price/E
1½" - 2½"	SMB1525	\$54.05
	SMB450	77.60

Storz Caps

Features:

- 4", 5", 6" supplied with cables
- 1½", 2", 2½", 3" supplied with chains



Storz Size	Aluminum	
	Part #	Price/E
1½"	SC150-NL	\$111.75
2"	SC200-NL	111.75
2½"	SC250-NL	115.75
3"	SC300-NL	158.85
4"	SC400-NL	178.80
4" ABS	SC400ABS¹	220.50
5"	SC500-NL	214.30
5" ABS	SC500ABS¹	300.00
6"	SC600-NL	342.75

¹ ABS includes airbleeder/petcock

Storz Gaskets

Features:

- gasket faces should be kept free of sand, grit, etc. and lubricated with O-ring grease or silicone 
- pressure seals have a flat face
- suction seals have a beaded face



Storz Size	Buna-N		Buna-N	
	Pressure Part #	Price/E	Suction Part #	Price/E
1½"	SGS150-NL¹	\$15.10	SGS150-NL	\$15.10
2"	SGP200	9.20	SGS200-NL	12.70
2½"	SGP250	9.20	SGS250-NL	19.70
3"	SGP300	9.20	SGS300-NL	20.50
4"	SGP400	13.80	SGS400-NL	47.25
5"	SGP500	21.25	SGS500-NL	53.40
6"	SGS600-NL¹	51.25	SGS600-NL	51.25

¹ gasket can be used for both pressure and suction service

Storz Locking Device



Description	Part #	Price/E
metal locking device used on 4" and 5" Storz heads with spring, screw and washer	LOCKINGDEVICE	\$31.50
metal locking device used on 6" Storz heads with spring, screw and washer	LOCKINGDEVICE6	60.00

Universal Spanner Wrench

Features:

- for ¾" to 3" pin lug and rocker lug couplings
- includes gas cock shutoff, pry bar and belt hook eye
- overall length 11 1/8"

Part #	Aluminum	Price/E	Pkg Qty
USW		\$24.70	25



Universal Wrench

Features:

- for pin lug or rocker lug couplings 1" - 4 1/2"
- a gas cock shutoff is provided in the handle
- red epoxy painted
- overall length 11 3/4"

Part #	Iron	Price/E
233		\$43.20



Hole Type Spanner Wrench

Features:

- designed for use on ¾" and 1" booster hose couplings
- overall length is 7 1/2"

Part #	AL-MAG 35	Price/E
HTSW		\$15.00



Storz Hydrant Wrench

Features:

- fits 4" and 5" Storz
- ductile iron head
- knurled chrome plated handle
- manganese bronze adjustable jaw
- includes adjustable hydrant nut wrench

Part #	Price/E
SAHW	\$100.00



Folding Pocket Spanner Wrenches

Features:

- for pentagon nuts up to 1 3/4"
- built-in spanner for pin or rocker lug couplings
- overall length 16 1/4"

Material	Part #	Price/E
aluminum	PSW	\$43.00
brass	PSW-B	171.10
die cast zinc	PSW-Z	41.35
yellow plastic	PSW-Y	86.65

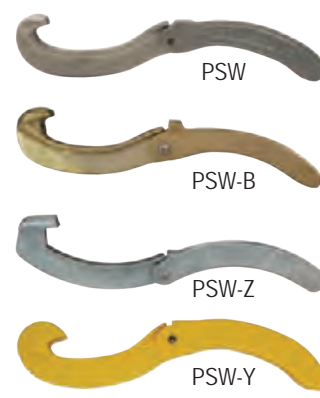

Adjustable Hydrant Wrench

Features:

- fits ¾" to 3" rocker lug and pin lug couplings
- a compact wrench easily carried in your jacket pocket

Part #	Aluminum	Price/E	Pkg Qty
AHW		\$40.20	20



Pigtail Adjustable Hydrant Wrench

Feature:

- double spanner head fits pin lug or rocker (sensible) lug couplings, pentagon nuts up to 1½" from point to flat, 1½" - 6" rocker lug caps, 2" - 4½" pin lug caps, and square nuts up to 1⅝"



Part #	Price/E
AHWPT	\$69.25

Heavy Duty Adjustable Hydrant Wrench

Features:

- for pentagon hydrant nuts up to 1¼" from point to flat
- notched to fit 1¼" square hydrant nut
- spanner for pin lug and sensible (rocker) lug couplings, 1½" thru 6"
- plated iron head, ⅞" plated steel handle
- overall length 18"



Part #	Price/E	Pkg Qty
189	\$38.70	15

Double Head Adjustable Hydrant Wrench

Features:

- for pentagon hydrant nuts up to 1⅞" and square heads up to 1½"
- fits ¾" - 6" rocker lug or pin lug couplings, can also be used for long handle couplings
- ductile iron head with a deeply knurled chrome plated steel handle
- replaceable adjustable jaw is made of manganese bronze
- overall length 19½"



Part #	Price/E
189DH	\$86.25

5 Hole Hydrant Wrench

Features:

- 5 pentagon holes designed to fit common hydrant nut sizes
- built-in spanner for pin or rocker lug couplings
- overall length: 14¼"



Part #	<i>Plated Iron</i>	Price/E	Pkg Qty
PHW		\$24.00	25

Grip-All Spanner Wrench

Features:

- fits ¾" - 6" split lug, rocker lug and pin lug couplings
- can be operated in tight quarters
- gas cock shutoff is provided in the handle, handle is shaped to fit your hand allowing a positive grip on the coupling



Part #	<i>Aluminum</i>	Price/E
GAW		\$23.25

Hydrant Wrenches

Application:

- used for hydrant work by water works companies and on construction sites

Features:

- overall length 15"
- fits up to 4" pin lug or rocker lug couplings
- complete with pry bar
- 1 1/4" square hydrant wrench



A356 Aluminum		
Part #		Price/E
DF16-180		\$38.00

Features:

- fits up to 2 1/2" pin lug or rocker lug couplings
- complete with pry bar and 1 1/4" nut wrench
- lug / drum wrench



A356 Aluminum		
Part #		Price/E
DF16-181		\$37.00

Long Handle Suction Spanner Wrench

Features:

- use on long handle, rocker lug, or pin lug couplings from 2 1/2" - 6"
- open end slips over long handles for additional leverage, the claw fits rocker lugs or pin lugs, the other end can be used as a pry or crowbar
- inverted "T" body construction for lighter weight and improved strength
- can be used on Dixon® cam and groove pin lug or trapezoidal lug tank car adapters or 8" pin lug couplings
- overall length 18 3/4"



Plated Iron		
Part #		Price/E
LHW		\$439.95

Forestry Hose Clamp and Spanner

Features:

- material: cast aluminum and brass
- off-set handle enables the user to easily operate the clamp while wearing gloves
- to be used with lightweight 1" and 1 1/2" hoses for pressures up to 200 PSI
- when clamped on the hose the brass locking device safely holds the clamp in position, a spanner is an integral part of the clamp
- overall length 10"



Cast Aluminum		
Part #		Price/E
FHCS150		\$199.55

Forestry Pocket Spanner Wrenches

Features:

- FSW1: for use on 1" hoses only
- FSW2: for 1" and 1 1/2" hose couplings
- overall length 5"
- meets USFDA specification 5100-101C



Aluminum		
Part #		Price/E
FSW1		\$47.25
FSW2		47.25

Storz Wrenches

Pipe, Welding & Tube Fittings

Pin Lug Spanner Wrenches - Single End



Size	Part #	Plated Iron	
		Price/E	
2"	SW20	\$10.15	
2½"	SW25	11.55	
3"	SW30	13.25	
4"	SW40	13.85	
6"	SW60	84.85	

Pin Lug Spanner Wrenches - Double End



Size	Part #	Plated Iron	
		Price/E	
1½", 2" x 2½", 3"	SW153	\$25.50	

Spanner Wrench - Single End



SZW2

- Features:**
- SW1530 fits 1½" - 3" Storz
 - SZW2 for use on 4" and 6" Storz



SW1530

Size	Part #	AL-MAG 35	
		Price/E	
1½" - 3"	SW1530	\$66.00	
4" - 6"	SZW2	23.23	

Spanner Wrenches - Double End



SZW2-NL



SW-S400

Used On	Material	Part #	Price/E
2" - 5"	<i>aluminum</i>	SZW2-NL	\$61.20
2" - 5"	<i>steel</i>	SW-S400	50.00

Holder with (2) Wrenches - Double Ended



Description	Material	Part #	Price/E
2 Storz wrenches (2½" - 5") with bracket	<i>aluminum</i>	SWB-2	\$181.30
2 Storz wrenches (2½" - 5") with bracket	<i>steel</i>	SWB-S-2	175.70
4 Storz wrenches (2½" - 5") with bracket	<i>steel</i>	SWB-S-4	261.60

Long Handle Short Shank Suction Hose Females

Features:

- powder coated aluminum swivel nut
- for suction and low pressure discharge only

Female Swivel NST (NH)	Hose Size	Powder Coated Aluminum	
		Part #	Price/E
4"	4"	LHFS400F	\$140.00
4½"	4"	LHFS4045F	297.25



Pipe, Welding & Tube Fittings

Angle and Suction Elbows

Features:

- for use on pump discharge valves, or suction inlets to minimize hose kinking
- rocker lug swivel
- satin brass finish
- -C polished chrome plated

Male NST (NH) Thread	Female NST (NH) Thread	Angle	Brass	
			Part #	Price/E
2½"	2½"	30°	RSE30250F-C	\$358.10
		45°	RSE45250F	209.10
		45°	RSE45250F-C	298.00
		90°	RSE90250F	216.00
		90°	RSE90250F-C	242.00



30° elbow



45° elbow

Continuous Swivel Elbows

Features:

- allows hose to swing when connected
- full waterway reduces friction loss
- short style radius is 2½" measured from the center of the waterway to the end of the discharge thread

Female NPT Thread	Male Thread	Length	Cast Brass	
			Part #	Price/E
1½"	1½" NST (NH)	2½"	CSES150F	\$180.00
2"	1½" NST (NH)	2½"	CSES2015F	180.00
1½"	1½" NPT	2½"	CSES150T	180.00



Dixon® Angle and Suction Elbows N54

Features:

- ideal for fire apparatus with front suction connections
- anodized, powder coated aluminum, extruded
- anodized female swivel connections

Male NST (NH) Thread	Female NST (NH) Swivel Thread	Angle	Aluminum	
			Part #	Price/E
2½"	2½"	30°	N5430-25F25F	\$318.70
		45°	N5445-25F25F	262.50
		60°	N5460-25F25F	330.90
		90°	N5490-25F25F	332.80



90° elbow

• Replacement washers can be found on page J-99

Pump Test Headers

Pipe, Welding & Tube Fittings



flanged



Features:

- available connections: grooved, flanged and threaded
- certified D1, G1, G6
- other sizes, configurations available, consult Dixon® for information

End Connection	End Size	# of Outlets	Pump Size Max. GPM	Part #	Price/E
150# flanged	3"	1	300	<i>HVF0301-25</i>	\$454.35
	4"	2	500	<i>HVF0402-25</i>	749.15
	6"	3	750	<i>HVF0603-25</i>	1126.80
	6"	4	1000	<i>HVF0604-25</i>	1263.50
	6"	6	1000	<i>HVF0606-25</i>	1537.05
	8"	6	2000	<i>HVF0806-25</i>	1966.25
grooved	6"	3	750	<i>HVG0603-25</i>	808.15
	6"	4	1000	<i>HVG0604-25</i>	945.00
	8"	3	750	<i>HVG0803-25</i>	1008.30
	8"	6	2000	<i>HVG0806-25</i>	1453.80

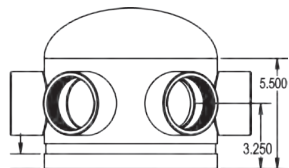

grooved

Manifolds



Model Number Breakdown

T98060-30

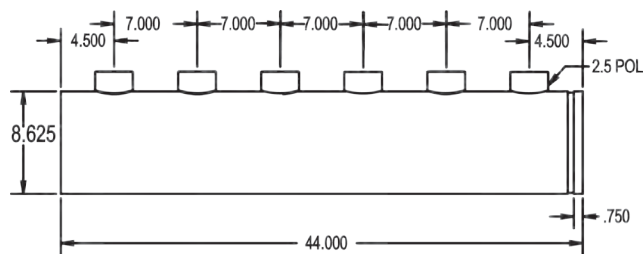
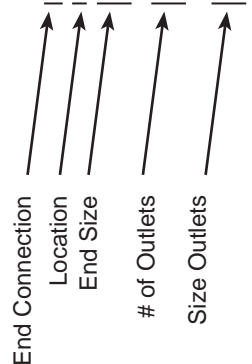

End Connection		Location		End Size		# of Outlets		Outlet Size	
T	threaded	E	End	40	4"	20	2	25	2½" FNPT
G	grooved	B	Back	60	6"	30	3	30	3" FNPT
F	flanged	9	90°	80	8"	40	4	---	---
---	---	---	---	---	---	60	6	---	---

Two Way Male Outlet - Roof Connections



Features:

- Used to create roof connections, fire pump test connections, wall hydrants or sidewalk (free standing) hydrants
- provides 250 GPM minimum per outlet
- UL listed
- maximum operating pressure: **175 PSI at 70°F (21°C)**
- other configurations are available, contact Dixon® for additional information

back outlet

Pipe Size	(2) Outlets Male	Cast Brass	
		Part #	Price/E
4"	2½" NPT	IRC4025	\$229.40
	2½" NPT	FRC4025	443.85
	2½" NST (NH)	IRC4025F	229.40
	2½" NST (NH)	FRC4025F	443.85
6"	2½" NPT	FRC6025	657.10
	2½" NST (NH)	FRC6025F	657.10



Groove Size	(2) Outlets Male	Cast Brass	
		Part #	Price/E
4"	2½" NST (NH)	IRC4025GF	\$229.40



Dimensions

Size	A	B	C
4" x 2½" x 2½"	7-7/8"	5-3/16"	5-1/4"
6" x 2½" x 2½"	8-3/16"	6-3/8"	7-5/8"

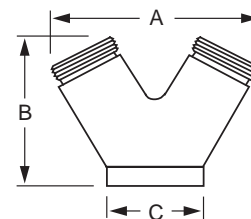



Two Way Male Outlet - Roof Connections

Features:

- Used to create roof connections, fire pump test connections, wall hydrants or sidewalk (free standing) hydrants
- provides 250 GPM minimum per outlet
- UL listed
- maximum operating pressure: **175 PSI at 70°F (21°C)**

90° bottom outlet



Pipe Size	(2) Outlets Male	Cast Brass	
		Part #	Price/E
4"	2½" NPT	90IRC4025	\$269.95
	2½" NPT	90FRC4025	474.35
	2½" NST (NH)	90IRC4025F	269.95
	2½" NST (NH)	90FRC4025F	474.35
6"	2½" NPT	90FRC6025	656.30
	2½" NST (NH)	90FRC6025F	656.30



Groove Size	(2) Outlets Male	Cast Brass	
		Part #	Price/E
4"	2½" NPT	90IRC4025G	\$274.20
	2½" NST(NH)	90IRC4025GF	274.20

Dimensions

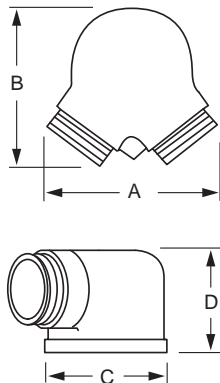

Size	A	B	C	D
4" x 2½" x 2½"	7½"	6¾"	5⅙"	4½"
6" x 2½" x 2½"	9"	8½"	7½"	5"

Three Way Male Outlet - Roof Connections

Features:

- used to create roof connections, or fire pump test connections
- provides 250 GPM minimum per outlet

Pipe, Welding & Tube Fittings

back outlet

Pipe Size	(3) Outlets Male	Cast Brass	
		Part #	Price/E
4"	2½" NPT	FR3C4025	\$925.95
6"	2½" NPT	FR3C6025	2072.55
	2½" NST (NH)	FR3C6025F	2197.40



Dimensions

Size	A	B	C
4" x 2½" x 2½" x 2½"	12¾"	8¾"	5¼"
6" x 2½" x 2½" x 2½"	15⅝"	9¾"	7⅝"

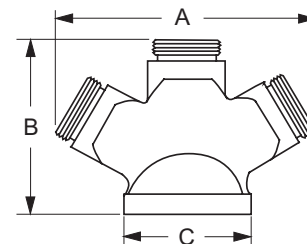

bottom outlet

Pipe Size	(3) Outlets Male	Cast Brass	
		Part #	Price/E
4"	2½" NPT	90FR3C4025	\$2071.70
	2½" NST (NH)	90FR3C4025F	2071.70
6"	2½" NPT	90FR3C6025	1404.10
	2½" NST (NH)	90FR3C6025F	1404.10



Dimensions

Size	A	B	C	D
4" x 2½" x 2½" x 2½"	7¾"	11¾"	4-7/16"	6¼"
6" x 2½" x 2½" x 2½"	7¾"	11¾"	4-7/16"	6¼"

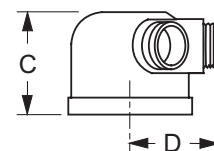
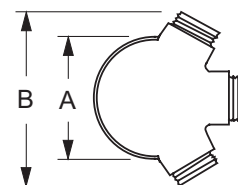

Sleeve for Sidewalk (free standing) Connections

Features:

- used in conjunction with a sidewalk escutcheon and a 90° double clapper Siamese to create a sidewalk (free standing) fire department connection
- finishes: -P polished, -C polished chrome plated

Pipe Size	Length	Brass	
		Part #	Price/E
4"	18"	SS418-P	\$589.95
	18"	SS418-C	652.95
	24"	SS424-P	538.40
	24"	SS424-C	630.00
6"	18"	SS618-P	589.95
	18"	SS618-C	813.30
	24"	SS624-P	893.50
	24"	SS624-C	1071.00



Round **Identification Plates**

Pipe, Welding
& Tube Fittings



REP250AS-C



REP250AS-P



REP400AS



Features:

- used to trim out and identify exposed fire department connections
- for Siamese, made in 9 1/4" diameter for 4" pipe and 11 1/4" diameter for 6" pipe
- finishes: -P polished, -C polished chrome plated

Pipe Size	Branding	Cast Brass	
		Part #	Price/E
2 1/2"	Auto-Sprinkler	REP250AS	\$90.45
	Auto-Sprinkler	REP250AS-P	132.95
	Auto-Sprinkler	REP250AS-C	162.70
	Wall Hydrant	REP250HY	90.45
	Pump Test	REP250PT	90.45
	Standpipe	REP250SP	90.45
	Standpipe	REP250SP-P	132.95
	Standpipe	REP250SP-C	162.70
	4"	Auto-Sprinkler	AREP400AS ¹
Auto-Sprinkler		REP400AS	181.80
Auto-Sprinkler		REP400AS-P	209.30
Auto-Sprinkler		REP400AS-C	268.55
Wall Hydrant		REP400HY	181.80
Standpipe		REP400SP	181.80
Standpipe		REP400SP-P	209.30
Standpipe		REP400SP-C	268.55
Auto-Sprinkler & Standpipe		REP400AS/SP	209.30
6"	Auto-Sprinkler	REP600AS	231.40
	Auto-Sprinkler	REP600AS-P	246.85
	Auto-Sprinkler	REP600AS-C	320.75
	Standpipe	REP600SP	231.40
	Standpipe	REP600SP-P	246.85
	Standpipe	REP600SP-C	320.75

¹ aluminum

Dimensions

Size	OD	Hole Size
2 1/2"	7 5/8"	3 1/4"
4"	9 1/4"	4 5/8"
6"	11 1/4"	6 3/4"

British Instantaneous Fittings

Features:

- polished finish
- meets BS336 specifications

British Instantaneous female x female threads

Female BRIT Thread	Female Thread	Part #	Brass	
				Price/E
2½"	2½" NST (NH)	BID250F		\$139.00
	2½" NPT	BID250T		139.00
	2½" BSP	BID250B		139.00



British Instantaneous female x male threads

Female BRIT Thread	Male Thread	Part #	Brass	
				Price/E
2½"	2½" NST (NH)	BIB250F		\$129.00
	2½" NPT	BIB250T		129.00



British Instantaneous male x female threads

Male BRIT Thread	Female Thread	Part #	Brass	
				Price/E
2½"	2½" NST (NH)	BIA250F		\$102.00
	2½" NPT	BIA250T		102.00



British Instantaneous male x male threads

Male BRIT Thread	Male Thread	Part #	Brass	
				Price/E
2½"	2½" NST (NH)	BIF250F		\$97.95
	2½" NPT	BIF250T		97.95



British Instantaneous Fittings

British Instantaneous Plug



Size	Part #	Brass	Price/E
2½"	BIDP250		\$61.65

British Instantaneous Cap



Size	Part #	Brass	Price/E
2½"	BIDC250		\$126.00

British Instantaneous Hose Shanks



BIE150

Size	Part #	Brass	Price/E
2½" male BRIT x 1½" hose shank	BIE150		\$118.00
2½" male BRIT x 2½" hose shank	BIE250		125.00
2½" female BRIT x 1½" hose shank	BIC150		130.00
2½" female BRIT x 2½" hose shank	BIC250		143.00



BIC150

International Shore Connections

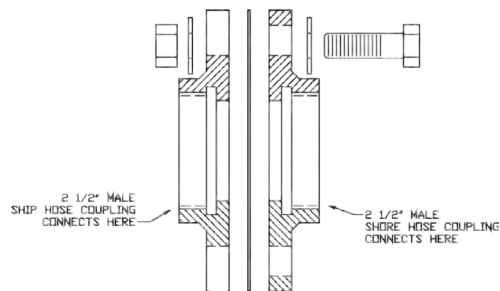
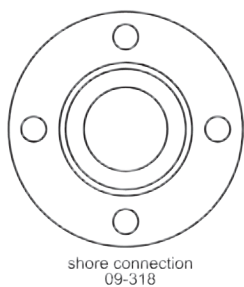
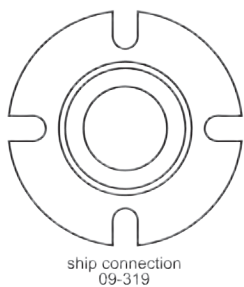

Features:

- meets US Coast Guard specifications for vessels 1000 gross tons or more
- makes possible the connection of two different threads between ship and shore or between ships
- 7" OD brass flange with 4 3/4" holes
- includes 8 washers, 4 hexagon brass nuts, 4 hex head bolts, 1 washer, 1 fiber gasket
- working pressure: **300 PSI**
- NST (NH) threads standard, also available in NPT and NYFD threads



shore side



ship side

Description	Part #	Brass	
			Price/E
shore side	09-318-00001		\$594.95
ship side	09-319-00001		628.25



Dry Hydrants

Typical Dry Hydrant Installations

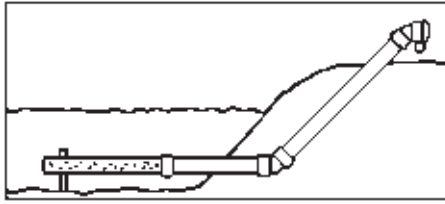

45°
(preferred)

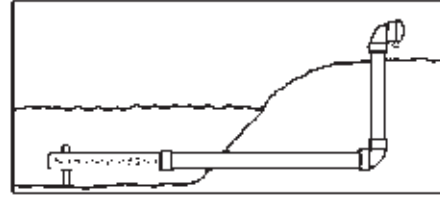

90°

Note: all dry hydrant products on this page will be discontinued once stock is depleted.

Underwater Strainer Support



Part #	Price/E
DHSSC6	\$154.40

Back Flushing Strainers



Size	Length	Schedule 40 PVC	
		Part #	Price/E
6"	37"	DHS6BF	\$397.85
8"		DHS8BF¹	767.25

¹ includes 8" x 6" reducer

Male Adapters and Caps



cap is included

90° Male Adapters

45° Male Adapters

Male NST (NH) Thread	Schedule 40 PVC			
	Part #	Price/E	Part #	Price/E
4½"	ADH90M45F	\$553.45	ADH45M45F	\$553.45
6"	ADH90M60F	746.70	ADH45M60F	746.70

Rocker Lug Caps with Cable

Female NST (NH) Thread	Hardcoated	
	Part #	Price/E
4½"	ADHC450F	\$306.60
6"	ADHC600F	365.80

Female Adapters and Plugs



plug is included

90° Female Adapters

45° Female Adapters

Female NST (NH) Thread	Hardcoated			
	Part #	Price/E	Part #	Price/E
4½"	ADH90F45F	\$746.70	ADH45F45F	\$553.45
6"	ADH90F60F	746.70	ADH45F60F	746.70

Rocker Lug Plugs with Cable

Male NST (NH) Thread	Hardcoated	
	Part #	Price/E
4½"	ADHP450F	\$306.60
6"	ADHP600F	365.80

Dixon® Low Level Strainer

Application:

- can be used as a low level strainer and as a water transfer device

Features:

- pivoting elbow enables the base to sit flat on the bottom of a portable tank
- base: 1/8" thick 5052 H32 marine grade aluminum, powder coated red with 45° angled edges, carrying handle mounted to base
- allows the user to draft within 2" of the bottom of the tank without whirlpooling
- jet is constructed from 3/4" pipe
- supplied with 304 stainless steel mesh strainer for fast fill flowing
- shipped with 1 1/2" male NPSH plug with wire cable attached to base
- elbow: 6" aluminum tube 6061-T6, powder coated red
- posts: welded between upper and lower base, 6061-T6 aluminum
- siphon jet: 3/4" ID 6061-T6 aluminum pipe, powder coated red
- elbow pivot rod: 1/4" thick, 304 stainless steel
- washers: polypropylene used for ease of elbow pivot and longer wear
- pivot bracket: 3/16" thick x 1 1/2" x 1 1/2", angle 6061-T6 aluminum
- 6" swivel: long handle, black anodized, 6061-T6 aluminum

Threaded Female Swivel with Jet Siphon

Thread	1 1/2" NPSH Part #	Price/E	1 1/2" NST (NH) Part #	Price/E
5" NST (NH)	NCS-LLSJ-50FS	\$1101.25	NCS-LLSJ-50FF	\$1431.85
6" NST (NH)	NCS-LLSJ-60FS	856.25	NCS-LLSJ-60FF	1129.90



with siphon jet

Threaded Female Swivel without Jet Siphon

Thread	Part #	Price/E
5" NST (NH)	NCS-LL-50F	\$891.35
6" NST (NH)	NCS-LL-60F	774.00

Barrel and Basket Strainers

Features:

- lightweight
- full-flow design
- rocker lugs
- tie off hook for drafting placement

Barrel Strainers - Female Threaded



Size	Hardcoat, Anodized Aluminum	
	NST (NH) Part #	Price/E
2½"	FST250F	\$321.90
3"	FST300F	340.30
4"	FST400F	507.35
6"	FST600F	634.30

Barrel Strainers - Storz



Size	Hardcoat, Anodized Aluminum	
	Part #	Price/E
4"	ST400	\$434.45
5"	ST500	960.65
6"	ST600	787.50

Basket Strainers - Female Threaded



Size	Hardcoat, Anodized Aluminum	
	NST (NH) Part #	Price/E
2½"	BSKTST250F	\$372.30
3"	BSKTST300F	389.50
4"	BSKTST400F	515.50
5"	BSKTST500F	630.00
6"	BSKTST600F	601.40

Floating Strainers

Feature:

- steel screen

Female Swivel

Female Inlet	Aluminum			
	NST (NH) Part #	Price/E	NPSH Part #	Price/E
5"	NCS-FDFS-50F	\$1548.95	NCS-FDFS-50S	\$1548.95
6"	NCS-FDFS-60F	1548.95	NCS-FDFS-60S	1548.95



Storz

Storz Inlet	Aluminum	
	Part #	Price/E
5"	NCS-FDSTZ-50	\$1689.55
6"	NCS-FDSTZ-60	1522.15



Tank Round Hole Strainers

Female NPT	Cast Brass	
	Part #	Price/E
5"	BS500	\$621.05
6"	BS600	1726.85
8"	BS800	2459.70



Clamps

Service pressure ratings are based on the following parameters: matching elastomer gaskets and weld ferrules properly aligned and assembled with the clamps tightened to the required torque (25 in. lbs.). Tests are done hydrostatically with no water hammer or shock loads. Please note the pressure ratings of the described unions are above the recommended pipe line operating pressures. 

Dimensions are approximate. Engineering dimensions are available upon request. Specifications are subject to change without notice.

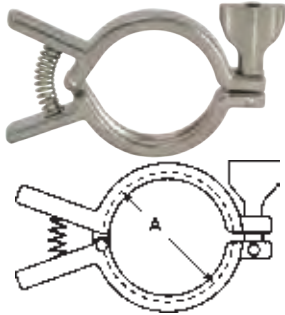

Single Pin Squeeze Clamps - 13MHHM-Q

Tube OD	Service Pressure PSI Rating @ 70°F (21°C) ¹	Service Pressure PSI Rating @ 250°F (121°C) ¹	Dimension A	Stainless Steel	
				Part #	Price/E
½" - ¾"	1500	1200	1.062"	13MHHM-Q75	\$32.36
1" - 1½"	500	300	2.122"	13MHHM-Q100150	39.32
2"	450	250	2.654"	13MHHM-Q200	45.88
2½"	400	200	3.185"	13MHHM-Q250	59.07
3"	350	175	3.717"	13MHHM-Q300	66.39
4"	300	150	4.820"	13MHHM-Q400	76.96

Single Pin Heavy Duty Clamps - 13MHHM
with cross hole wing nut

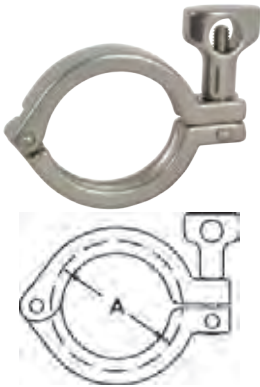

Tube OD	Service Pressure PSI Rating @ 70°F (21°C) ¹	Service Pressure PSI Rating @ 250°F (121°C) ¹	Dimension A	Stainless Steel	
				Part #	Price/E
½" - ¾"	1500	1200	1.062"	13MHHM50-75	\$9.19
1" - 1½"	500	300	2.122"	13MHHM100-150	13.93
2"	450	250	2.654"	13MHHM200	16.89
2½"	400	200	3.185"	13MHHM250	19.66
3"	350	175	3.717"	13MHHM300	21.81
4"	300	150	4.820"	13MHHM400	26.12
5"	225	100	5.820"	13MHHM500	57.84
6"	150	75	6.695"	13MHHM600	57.51
8"	100	50	8.695"	13MHHM800	82.87

Single Pin Heavy Duty Clamps - 13MHHM***SN
with serrated wing nut

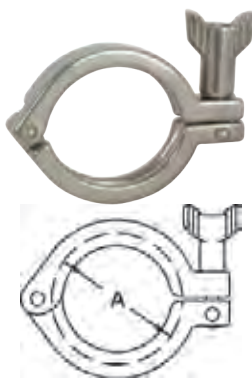

Tube OD	Service Pressure PSI Rating @ 70°F (21°C) ¹	Service Pressure PSI Rating @ 250°F (121°C) ¹	Dimension A	Stainless Steel	
				Part #	Price/E
½" - ¾"	1500	1200	1.062"	13MHHM50-75SN	\$9.19
1" - 1½"	500	300	2.122"	13MHHM100-150SN	13.93
2"	450	250	2.654"	13MHHM200SN	16.89
2½"	400	200	3.185"	13MHHM250SN	19.66
3"	350	175	3.717"	13MHHM300SN	21.81
4"	300	150	4.820"	13MHHM400SN	26.12
5"	225	100	5.820"	13MHHM500SN	57.84
6"	150	75	6.695"	13MHHM600SN	57.51
8"	100	50	8.695"	13MHHM800SN	82.58

Double Pin Heavy Duty Clamps - 13MHHM-DP

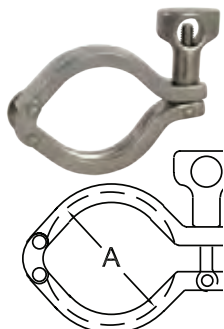

Tube OD	Service Pressure PSI Rating @ 70°F (21°C) ¹	Service Pressure PSI Rating @ 250°F (121°C) ¹	Dimension A	Stainless Steel	
				Part #	Price/E
1" - 1½"	500	300	2.122"	13MHHM-DP100150	\$18.84
2"	450	250	2.654"	13MHHM-DP200	21.22
2½"	400	200	3.185"	13MHHM-DP250	27.00
3"	350	175	3.717"	13MHHM-DP300	30.46
4"	300	150	4.820"	13MHHM-DP400	32.77
10"	100	50	10.740"	13MHHM-DP1000	280.05

¹ wing nut tightened to 25 in. lb. of torque

Clamps

Three Segment Clamps - 13MHHM-3P

Tube OD	Service Pressure PSI Rating @ 70°F (21°C) ¹	Service Pressure PSI Rating @ 250°F (121°C) ¹	Dimension A	Stainless Steel	
				Part #	Price/E
1" - 1½"	600	300	2.122"	13MHHM-3P100150	\$28.43
2"	550	275	2.654"	13MHHM-3P200	31.88
2½"	450	225	3.185"	13MHHM-3P250	38.27
3"	350	175	3.717"	13MHHM-3P300	44.58
4"	300	150	4.820"	13MHHM-3P400	54.32
12"	75	50	12.740"	13MHHM-3P1200	642.41

¹ wing nut should be tightened to 25 in. lb. of torque



Pipe, Welding
& Tube Fittings

Bolted Clamps - 13MHP

Tube OD	Service Pressure PSI Rating @ 70°F (21°C) ¹	Service Pressure PSI Rating @ 250°F (121°C) ¹	Dimension A	Stainless Steel	
				Part #	Price/E
½" - ¾"	1500	1200	1.062"	13MHP75	\$28.92
1" - 1½"	1500	1200	2.046"	13MHP100-150	28.80
2"	1000	800	2.578"	13MHP200	35.88
2½"	1000	800	3.110"	13MHP250	39.50
3"	1000	800	3.640"	13MHP300	49.17
4"	800	600	4.744"	13MHP400	51.64
6"	300	200	6.632"	13MHP600	92.39
8"	250	150	8.638"	13MHP800	192.73
10"	200	125	10.740"	13MHP1000	220.98
12"	150	100	12.740"	13MHP1200	260.02

¹ nuts should be tightened to 20 ft. lbs. of torque

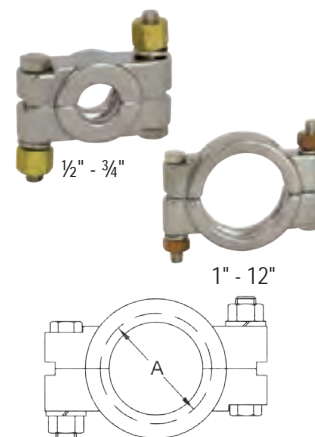

Toggle Clamps - 13MHLA

Tube OD	Service Pressure PSI Rating @ 70°F (21°C) ¹	Service Pressure PSI Rating @ 250°F (121°C) ¹	Dimension A	304 Stainless Steel	
				Part #	Price/E
1" - 1½"	150	125	2.122"	13MHLA100-150	\$34.83
2"	150	125	2.654"	13MHLA200	36.69
2½"	150	125	3.185"	13MHLA250	40.76
3"	150	125	3.717"	13MHLA300	58.89
4"	100	75	4.820"	13MHLA400	67.68

¹ screw tightened to maximum



T-bolt Clamps - 13MO

Tube OD	Service Pressure PSI Rating @ 70°F (21°C) ¹	Service Pressure PSI Rating @ 250°F (121°C) ¹	Dimension A	304 Stainless Steel	
				Part #	Price/E
1" - 1½"	500	250	2.080"	13MO100-150	\$30.46
2"	350	200	2.610"	13MO200	34.67
2½"	300	150	3.140"	13MO250	42.49
3"	200	100	3.670"	13MO300	43.73
4"	100	75	4.780"	13MO400	57.61
6"	75	50	6.690"	13MO600	84.17
8" ¹	50	40	8.690"	13MO800	125.52
10" ¹	40	30	10.690"	13MO1000	164.71
12" ¹	30	25	12.690"	13MO1200	222.22

¹ 2 bolt configuration

² 1" - 3" nuts tightened to 20 in. lb., 4" nut tightened to 30 in. lb., 6" nut tightened to 40 in. lb. and 8" - 12" nuts tightened to 50 in. lb. of torque



Clamps

Dairy Clamps - 13WGC



Tube OD	Service Pressure PSI Rating @ 70°F (21°C) ¹	Dimension A	304 Stainless Steel	
			Part #	Price/E
1" - 1½"	80	2.080"	13WGC100-150	\$13.19
2"	80	2.610"	13WGC200	13.76
2½"	60	3.140"	13WGC250	16.96
3"	40	3.670"	13WGC300	18.19
4"	40	4.780"	13WGC400	21.55

¹ finger tight

Accessories

Spring Loaded Nut - 13SLN



Features:

- Beneficial for lines using PTFE gaskets that are subject to large temperature swings, as the PTFE is compressed through the cycling of the lines, the spring load will help keep the connection from leaking.
- If the lines suffer from vibration and bolted clamps are not an option, refitting single pin clamps with this nut will keep the connections from leaking for a longer time than with standard wing nuts.
- Spring loaded nuts can add a level of insurance to shipments, of transported material in tanks via truck, where vibrations can loosen the standard single pin clamps.
- can be used on all wing nut style clamps
- torque to 50 in. lb.

Thread	Dimension A	Dimension B	304 Stainless Steel	
			Part #	Price/E
5/16" - 18	1.73"	.875"	13SLN	\$90.18

Nuts and Bolts



Description	Part #	Price/E
cross hole wing nut 5/16"-18	13WNX	\$11.39
mini cross hole wing nut 5/16"-18, for 1/2" - 3/4" clamps	13WNXM	11.88
serrated wing nut 5/16"-18	13WNS	11.22
hex wing nut 5/16"-18	13WNH	7.41
bronze hex nut 3/8"-16, for bolted clamps	13BN	3.25
bolt 3/8"-16 x 2-1/4", for 1-1/2" bolted clamps	13CB-2.25	8.24
bolt 3/8"-16 x 2-3/4", for 2" and 2-1/2" bolted clamps	13CB-2.75	8.24
bolt 3/8"-16 x 3¼", for 3" - 12" bolted clamps	13CB-3.25	8.24
rivet pin, for 1/2" - 5" single pin clamps 5/16" x 1"	13RP	2.87
rivet pin, for 6" and 8" single pin clamps 5/16" x 1-1/8"	13RP6	2.05
5/16"-18 x 2" threaded eye bolt, for 1/2" - 5" clamps	13IB	2.82
5/16"-18 x 2-1/2" threaded eye bolt, for 6" - 12" clamps	13IB6	3.08
brass 3/8"-16 nuts, for 10" and 12" bolted clamps	13BNH	3.98
stainless steel hex nut, for bolted clamps	13SN	1.00
3/8" lockwasher 304 stainless steel, for bolted clamps	13LW	0.19

Clamp Fittings - Ferrules

Short Weld Ferrules - 14WMP

Tube OD	Dimensions			304 Stainless Steel		316L Stainless Steel	
	A	B	C	Part #	Price/E	Part #	Price/E
½"	.500"	.370"	.500"	14WMP-G50	\$6.36	14WMP-R50	\$9.21
¾"	.500"	.620"	.750"	14WMP-G75	6.88	14WMP-R75	9.21
1"	.500"	.870"	1.000"	14WMP-G100	6.88	14WMP-R100	8.77
1½"	.500"	1.370"	1.500"	14WMP-G150	6.88	14WMP-R150	8.77
2"	.500"	1.870"	2.000"	14WMP-G200	7.42	14WMP-R200	10.24
2½"	.500"	2.370"	2.500"	14WMP-G250	11.32	14WMP-R250	16.16
3"	.500"	2.870"	3.000"	14WMP-G300	14.21	14WMP-R300	20.12
4"	.625"	3.834"	4.000"	14WMP-G400	22.37	14WMP-R400	29.02
5"	.750"	4.782"	5.000"	14WMP-G500	368.59	14WMP-R500	553.85
6"	.875"	5.782"	6.000"	14WMP-G600	78.27	14WMP-R600	122.88
8"	.875"	7.760"	8.000"	14WMP-G800	107.12	14WMP-R800	235.94
10"	.875"	9.782"	10.000"	14WMP-G1000	247.83	14WMP-R1000	314.68
12"	.875"	11.760"	12.000"	14WMP-G1200	400.15	14WMP-R1200	488.74



Pipe, Welding & Tube Fittings

Long Weld Ferrules - L14AM7

Tube OD	Dimensions			304 Stainless Steel		316L Stainless Steel	
	A	B	C	Part #	Price/E	Part #	Price/E
½"	1.125"	.370"	.500"	L14AM7-G50	\$8.44	L14AM7-R50	\$10.76
¾"	1.125"	.620"	.750"	L14AM7-G75	8.44	L14AM7-R75	10.76
1"	1.125"	.870"	1.000"	L14AM7-G100	9.67	L14AM7-R100	13.11
1½"	1.125"	1.370"	1.500"	L14AM7-G150	9.67	L14AM7-R150	13.11
2"	1.125"	1.870"	2.000"	L14AM7-G200	11.93	L14AM7-R200	15.09
2½"	1.125"	2.370"	2.500"	L14AM7-G250	15.78	L14AM7-R250	22.89
3"	1.125"	2.870"	3.000"	L14AM7-G300	20.30	L14AM7-R300	26.41
4"	1.125"	3.834"	4.000"	L14AM7-G400	27.77	L14AM7-R400	37.86
6"	1.500"	5.782"	6.000"	L14AM7-G600	120.33	L14AM7-R600	151.61
8"	1.500"	7.760"	8.000"	L14AM7-G800	156.54	L14AM7-R800	206.02
10"	1.750"	9.782"	10.000"	L14AM7-G1000	222.50	L14AM7-R1000	280.19
12"	1.750"	11.760"	12.000"	L14AM7-G1200	288.47	L14AM7-R1200	362.62

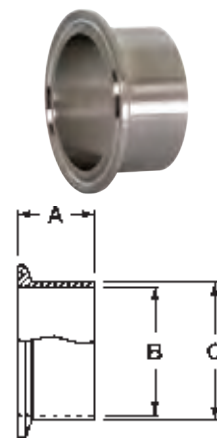

Automatic Weld Ferrules - TL14AM7

Specification:

- meets ASME BPE-2012 specifications

Tube OD	Dimensions			316L Stainless Steel	
	A	B	C	Part #	Price/E
½"	1.750"	.370"	.500"	TL14AM7-050PL	\$17.50
¾"	1.750"	.620"	.750"	TL14AM7-075PL	18.47
1"	1.750"	.870"	1.000"	TL14AM7-100PL	24.50
1½"	1.750"	1.370"	1.500"	TL14AM7-150PL	24.87
2"	2.250"	1.870"	2.000"	TL14AM7-200PL	31.47
3"	2.250"	2.870"	3.000"	TL14AM7-300PL	47.17
4"	2.250"	3.834"	4.000"	TL14AM7-400PL	80.45

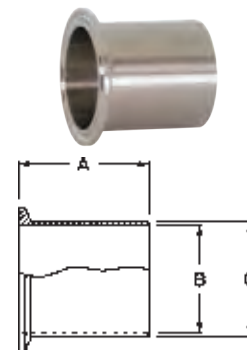

Tank Weld Ferrules (light duty) - 14WLMP

Tube OD	Dimensions			304 Stainless Steel		316L Stainless Steel	
	A	B	C	Part #	Price/E	Part #	Price/E
1"	3.000"	.870"	1.000"	14WLMP-G100	\$25.99	14WLMP-R100	\$45.27
1½"	3.000"	1.370"	1.500"	14WLMP-G150	31.44	14WLMP-R150	55.97
2"	3.000"	1.870"	2.000"	14WLMP-G200	34.82	14WLMP-R200	40.36
2½"	3.000"	2.370"	2.500"	14WLMP-G250	49.20	14WLMP-R250	78.43
3"	4.000"	2.870"	3.000"	14WLMP-G300	65.93	14WLMP-R300	102.65
4"	4.000"	3.834"	4.000"	14WLMP-G400	95.47	14WLMP-R400	104.68
6"	6.000"	5.782"	6.000"	14WLMP-G600	338.92	14WLMP-R600	423.46

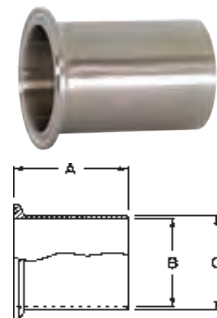

Clamp Fittings - Ferrules

Tank Weld Ferrules (heavy duty) - 14MPW

Specification:

- certified ASME materials

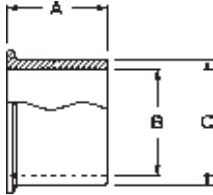

Tube OD	Dimensions			316L Stainless Steel	
	A	B	C	Part #	Price/E
½"	1.625"	.321"	.502"	14MPW-R50	\$35.31
¾"	1.625"	.574"	.750"	14MPW-R75	35.31
1"	1.625"	.870"	1.160"	14MPW-R100	32.69
1½"	1.625"	1.370"	1.676"	14MPW-R150	32.69
2"	1.750"	1.870"	2.192"	14MPW-R200	42.52
2½"	1.750"	2.370"	2.708"	14MPW-R250	61.18
3"	1.813"	2.870"	3.224"	14MPW-R300	80.94
4"	2.125"	3.834"	4.256"	14MPW-R400	133.78
6"	2.500"	5.758"	6.192"	14MPW-R600	373.16

Roll-on Ferrules for Expanding - 14RMP

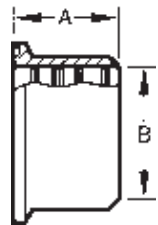

Tube OD	Dimensions		304 Stainless Steel		316L Stainless Steel	
	A	B	Part #	Price/E	Part #	Price/E
1"	.750"	1.005"	14RMP-G100	\$12.39	14RMP-R100	\$19.30
1½"	1.125"	1.505"	14RMP-G150	12.76	14RMP-R150	19.71
2"	1.312"	2.005"	14RMP-G200	14.75	14RMP-R200	21.15
2½"	1.375"	2.505"	14RMP-G250	21.05	14RMP-R250	32.69
3"	1.437"	3.005"	14RMP-G300	26.30	14RMP-R300	49.07
4"	1.500"	4.005"	14RMP-G400	33.18	14RMP-R400	53.07

¹ Meets 3-A Standard Number 63-03 when used to modify or repair existing on-site farm milk handling systems.

Reducing Ferrules - B31WMP

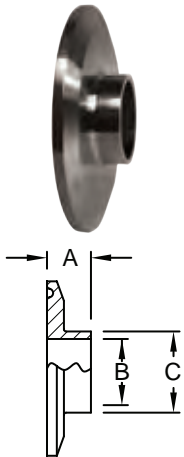

Tube OD	Dimensions			304 Stainless Steel	
	A	B	C	Part #	Price/E
2" x 1"	.500"	.870"	1.000"	B31WMP-G200100	\$145.20
2½" x 1½"	.500"	1.370"	1.500"	B31WMP-G250150	30.74
2½" x 2"	.500"	1.870"	2.000"	B31WMP-G250200	199.71
3" x 2"	.500"	1.870"	2.000"	B31WMP-G300200	242.61
4" x 3"	.625"	2.870"	3.000"	B31WMP-G400300	384.61

Clamp Fittings - Caps

Solid End Caps - 16AMP

- Specify if you are using a piping system or a tubing system when ordering.

Tube OD	Dimensions		304 Stainless Steel		316L Stainless Steel	
	A	B	Part #	Price/E	Part #	Price/E
½" - ¾"	.187"	.992"	16AMP-G50-75	\$6.32	16AMP-R50-75	\$7.75
1" - 1½"	.250"	1.984"	16AMP-G100-150	6.73	16AMP-R100-150	8.34
2"	.250"	2.516"	16AMP-G200	8.55	16AMP-R200	12.11
2½"	.250"	3.047"	16AMP-G250	13.06	16AMP-R250	18.30
3"	.250"	3.579"	16AMP-G300	17.63	16AMP-R300	24.23
4"	.312"	4.682"	16AMP-G400	33.46	16AMP-R400	44.48
5"	.376"	5.687"	16AMP-G500	480.77	16AMP-R500	86.73
6"	.437"	6.570"	16AMP-G600	112.05	16AMP-R600	154.67
8"	.437"	8.570"	16AMP-G800	246.87	16AMP-R800	271.79
10"	.437"	10.570"	16AMP-G1000	440.19	16AMP-R1000	783.69
12"	.437"	12.750"	16AMP-G1200	617.24	16AMP-R1200	1051.38



Thermometer Caps - B23BMP

Tube OD	Dimensions			304 Stainless Steel		316L Stainless Steel	
	A	B	C ¹	Part #	Price/E	Part #	Price/E
½"	.500"	.993"	¼" NPT	---	---	B23BMP-R5014	\$207.69
¾"	.500"	.993"	¼" NPT	---	---	B23BMP-R7514	230.78
1"	.625"	1.984"	½" NPT	B23BMP-G100	\$33.46	B23BMP-R100	49.96
1½"	.625"	1.984"	¾" NPT	B23BMP-G150	33.46	B23BMP-R150	49.96
2"	.625"	2.516"	¾" NPT	B23BMP-G200	44.07	B23BMP-R200	66.34
2½"	.625"	3.047"	¾" NPT	B23BMP-G250	60.57	B23BMP-R250	91.15
3"	.625"	3.579"	¾" NPT	B23BMP-G300	78.12	B23BMP-R300	116.54
4"	.625"	4.682"	¾" NPT	B23BMP-G400	114.58	B23BMP-R400	169.84

¹ other NPT tap sizes available, contact Dixon®

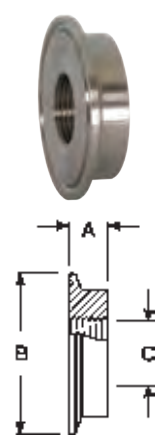

Clamp Fittings - Adapters

Tygon® Hose Adapters - 14MPHT

Tube OD	Dimensions			316L Stainless Steel	
	A	B	C	Part #	Price/E
¾"	4.000"	.620"	.750"	14MPHT-R75	\$96.00
1"	4.500"	.870"	1.000"	14MPHT-R100	58.38
1½"	4.500"	1.370"	1.500"	14MPHT-R150	49.71
2"	4.500"	1.870"	2.000"	14MPHT-R200	50.20
2½"	4.500"	2.370"	2.500"	14MPHT-R250	85.97
3"	4.500"	2.870"	3.000"	14MPHT-R300	72.52
4"	4.625"	3.834"	4.000"	14MPHT-R400	157.62

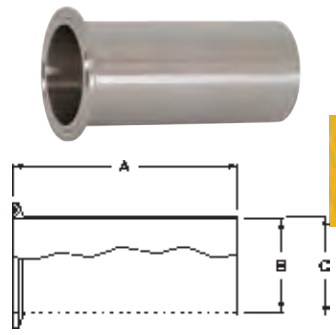

Clamp Fittings - Adapters

Pipe, Welding & Tube Fittings

Rubber Hose Adapters - 14MPHR

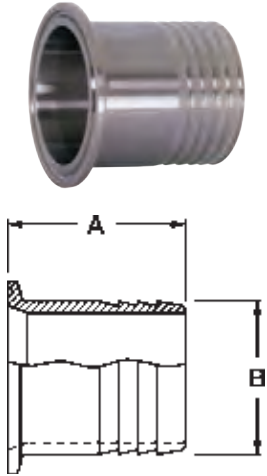

Tube OD	Hose Size	Dimensions		304 Stainless Steel		316L Stainless Steel	
		A	B	Part #	Price/E	Part #	Price/E
1/2"	1/4"	1.500"	.250"	---	---	14MPHR-R5025	\$93.21
	1/2"	1.500"	.500"	---	---	14MPHR-R50	83.35
	3/4"	1.500"	.750"	---	---	14MPHR-R5075	123.29
3/4"	1/4"	1.500"	.250"	---	---	14MPHR-R7525	99.29
	3/8"	1.500"	.375"	---	---	14MPHR-R75375	99.29
	1/2"	1.500"	.500"	---	---	14MPHR-R7550	93.21
	3/4"	1.500"	.750"	---	---	14MPHR-R75	83.35
1"	3/8"	1.500"	.375"	---	---	14MPHR-R100375	188.42
	1/2"	1.500"	.500"	---	---	14MPHR-R10050	146.51
	3/4"	1.688"	.750"	14MPHR-G10075	\$161.63	14MPHR-R10075	236.68
	1"	1.688"	1.000"	14MPHR-G100	36.42	14MPHR-R100	104.65
1 1/2"	1/2"	1.500"	.500"	14MPHR-G15050	71.08	14MPHR-R15050	139.84
	5/8"	1.500"	.625"	---	---	14MPHR-R150625	208.17
	3/4"	1.500"	.750"	14MPHR-G15075	71.08	14MPHR-R15075	139.84
	1"	1.687"	1.000"	14MPHR-G150100	76.25	14MPHR-R150100	141.01
	1 1/2"	1.689"	1.500"	14MPHR-G150	42.57	14MPHR-R150	110.66
2"	1 1/2"	2.312"	1.500"	14MPHR-G200150	141.83	14MPHR-R200150	223.90
	2"	2.312"	2.000"	14MPHR-G200	62.44	14MPHR-R200	149.69
2 1/2"	2 1/2"	2.344"	2.500"	14MPHR-G250	81.50	14MPHR-R250	69.26
3"	3"	3.094"	3.000"	14MPHR-G300	96.44	14MPHR-R300	268.61
4"	4"	3.406"	4.000"	14MPHR-G400	152.41	14MPHR-R400	120.71
6"	6"	3.406"	6.000"	14MPHR-G600	573.53	14MPHR-R600	168.65

Brewery Hose Barb Adapters - 14MPHRL

Feature:

- suitable for use with band clamps

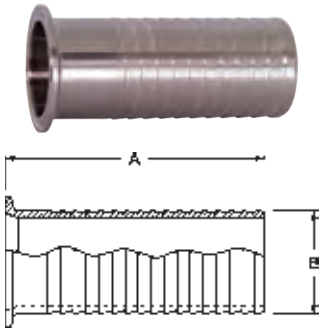

Tube OD	Dimensions		304 Stainless Steel	
	A	B	Part #	Price/E
1"	3.500"	1.045"	14MPHRL100	\$54.12
1 1/2"	5.000"	1.545"	14MPHRL150	66.60
2"	5.000"	2.045"	14MPHRL200	68.65
2 1/2"	5.500"	2.545"	14MPHRL250	79.81
3"	5.500"	3.045"	14MPHRL300	95.51
4"	5.500"	4.045"	14MPHRL400	152.54

Use of PVC tubing requires special installation techniques to prevent leakage. All assembly work must be done with heated tube. Cold durometer is 90 as opposed to rubber hose at 65 to 70 durometer. Banding buckles must be at 180° from one another. 

Clamp Fittings - Adapters

Male NPT Clamp Adapters - 21MP

Tube OD	NPT Size	Dimensions		304 Stainless Steel		316L Stainless Steel	
		A	B	Part #	Price/E	Part #	Price/E
1/2"	1/4"	2.000"	.595"	---	---	21MP-R5025	\$79.96
	3/8"	2.000"	.600"	---	---	21MP-R50375	80.69
	1/2"	1.625"	.782"	---	---	21MP-R50	65.08
	3/4"	2.000"	.794"	---	---	21MP-R5075	81.04
3/4"	1/4"	2.000"	.595"	---	---	21MP-R7525	90.21
	3/8"	2.000"	.600"	---	---	21MP-R75375	46.99
	1/2"	2.000"	.782"	---	---	21MP-R7550	94.29
	3/4"	1.787"	.794"	---	---	21MP-R75	60.79
1"	1/2"	2.187"	.782"	21MP-G10050	\$125.80	21MP-R10050	135.50
	3/4"	2.187"	.794"	21MP-G10075	91.38	21MP-R10075	135.50
	1"	2.250"	.985"	21MP-G100	73.04	21MP-R100	97.28
	1 1/4"	2.438"	1.009"	21MP-G100125	67.98	21MP-R100125	196.20
	1 1/2"	2.438"	1.025"	21MP-G100150	73.67	21MP-R100150	115.00
	2"	2.625"	1.058"	21MP-G100200	122.48	21MP-R100200	136.66
1 1/2"	3/8"	2.187"	.600"	21MP-G150375	57.67	21MP-R150375	79.88
	1/2"	2.187"	.782"	21MP-G15050	127.59	21MP-R15050	137.07
	3/4"	2.187"	.794"	21MP-G15075	127.59	21MP-R15075	137.07
	1"	2.437"	.985"	21MP-G150100	91.03	21MP-R150100	101.01
	1 1/4"	2.438"	1.009"	21MP-G150125	130.04	21MP-R150125	172.50
	1 1/2"	2.250"	1.025"	21MP-G150	77.07	21MP-R150	96.52
	2"	2.625"	1.058"	21MP-G150200	183.43	21MP-R150200	133.14
	2 1/2"	2.625"	1.058"	21MP-G150200	183.43	21MP-R150200	133.14
2"	1/2"	2.188"	.782"	21MP-G20050	102.94	21MP-R20050	118.90
	3/4"	2.188"	.794"	21MP-G20075	102.94	21MP-R20075	118.90
	1"	2.469"	.985"	21MP-G200100	161.91	21MP-R200100	239.17
	1 1/2"	2.625"	1.009"	21MP-G200150	104.76	21MP-R200150	132.44
	2"	2.638"	1.058"	21MP-G200	96.03	21MP-R200	139.17
2 1/2"	1/2"	2.781"	.782"	21MP-G25050	675.15	---	---
	1"	2.781"	.782"	21MP-G250100	143.40	21MP-R250100	225.14
	1 1/2"	2.781"	1.025"	21MP-G250150	143.40	21MP-R250150	455.55
	2"	2.781"	1.058"	21MP-G250200	309.64	21MP-R250200	173.73
	2 1/2"	2.875"	1.571"	21MP-G250	154.82	21MP-R250	190.06
3"	1 1/2"	3.000"	1.009"	21MP-G300150	236.09	21MP-R300150	694.55
	2"	3.000"	1.058"	21MP-G300200	236.09	21MP-R300200	278.28
	3"	3.070"	1.634"	21MP-G300	184.82	21MP-R300	246.18
4"	4"	3.155"	1.734"	21MP-G400	244.87	21MP-R400	675.29

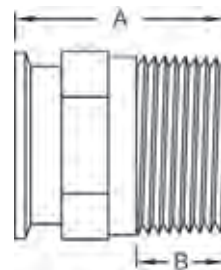

Clamp Fittings - Adapters

Female NPT Clamp Adapters - 22MP

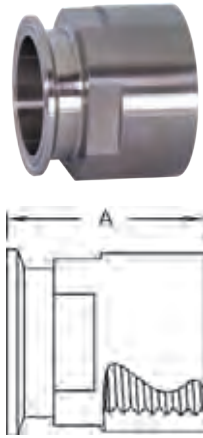

Tube OD	NPT Size	Dimension A	304 Stainless Steel		316L Stainless Steel	
			Part #	Price/E	Part #	Price/E
1/2"	1/4"	1.500"	---	---	22MP-R5025	\$66.49
	3/8"	1.500"	---	---	22MP-R50375	49.68
	1/2"	1.500"	---	---	22MP-R50	66.49
	3/4"	1.500"	---	---	22MP-R5075	56.85
3/4"	1/4"	1.500"	---	---	22MP-R7525	46.16
	1/2"	1.625"	---	---	22MP-R7550	74.80
	3/4"	1.625"	---	---	22MP-R75	60.31
1"	1/4"	1.625"	---	---	22MP-R10025	79.88
	1/2"	1.625"	22MP-G10050	\$62.11	22MP-R10050	215.98
	3/4"	1.625"	22MP-G10075	62.11	22MP-R10075	79.88
	1"	1.625"	22MP-G100	75.11	22MP-R100	97.28
	1 1/4"	1.625"	---	---	22MP-R100125	376.65
1 1/2"	1/2"	1.625"	22MP-G15050	62.11	22MP-R15050	215.98
	3/4"	1.625"	22MP-G15075	126.52	22MP-R15075	79.88
	1"	2.250"	22MP-G150100	76.47	22MP-R150100	88.30
	1 1/2"	2.250"	22MP-G150	82.30	22MP-R150	101.76
	2"	2.500"	22MP-G150200	97.64	22MP-R150200	217.95
2"	1"	1.687"	22MP-G200100	83.40	22MP-R200100	104.75
	1 1/2"	2.344"	22MP-G200150	100.32	22MP-R200150	85.20
	2"	2.406"	22MP-G200	94.28	22MP-R200	139.92
	2 1/2"	2.406"	22MP-G200250	333.93	---	---
2 1/2"	2"	2.093"	22MP-G250200	92.75	22MP-R250200	135.50
	2 1/2"	2.187"	22MP-G250	109.35	22MP-R250	240.00
3"	2"	2.187"	22MP-G300200	163.58	22MP-R300200	201.74
	2 1/2"	2.187"	22MP-G300250	136.60	---	---
	3"	2.187"	22MP-G300	168.43	22MP-R300	240.00
4"	4"	3.652"	22MP-G400	260.61	22MP-R400	254.93

Visit dixonvalve.com for pipe thread data

Clamp Fittings - Elbows

90° Clamp Elbows - B2CMP

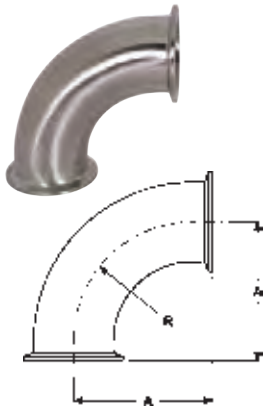

Tube OD	Dimensions		304 Stainless Steel		316L Stainless Steel	
	A	R	Part #	Price/E	Part #	Price/E
1/2"	1.625"	1.125"	---	---	B2CMP-R50	\$78.06
3/4"	1.625"	1.125"	---	---	B2CMP-R75	81.84
1"	2.000"	1.500"	B2CMP-G100	\$40.76	B2CMP-R100	53.84
1 1/2"	2.750"	2.250"	B2CMP-G150	42.12	B2CMP-R150	56.33
2"	3.500"	3.000"	B2CMP-G200	56.40	B2CMP-R200	79.09
2 1/2"	4.250"	3.750"	B2CMP-G250	76.11	B2CMP-R250	107.48
3"	5.000"	4.500"	B2CMP-G300	97.16	B2CMP-R300	142.69
4"	6.625"	6.000"	B2CMP-G400	180.87	B2CMP-R400	222.37
6"	9.875"	9.000"	B2CMP-G600	480.56	B2CMP-R600	567.24

Clamp Fittings - Elbows

3

45° Clamp Elbows - B2KMP

Tube OD	Dimensions		304 Stainless Steel		316L Stainless Steel	
	A	R	Part #	Price/E	Part #	Price/E
1/2"	.996"	1.125"	---	---	B2KMP-R50	\$89.66
3/4"	.966"	1.125"	---	---	B2KMP-R75	90.46
1"	1.125"	1.500"	B2KMP-G100	\$37.06	B2KMP-R100	50.74
1 1/2"	1.437"	2.250"	B2KMP-G150	40.76	B2KMP-R150	56.17
2"	1.750"	3.000"	B2KMP-G200	55.59	B2KMP-R200	70.13
2 1/2"	2.062"	3.750"	B2KMP-G250	74.12	B2KMP-R250	107.63
3"	2.375"	4.500"	B2KMP-G300	101.11	B2KMP-R300	133.17
4"	3.125"	6.000"	B2KMP-G400	160.83	B2KMP-R400	195.70
6"	4.625"	9.000"	B2KMP-G600	486.21	B2KMP-R600	1037.65

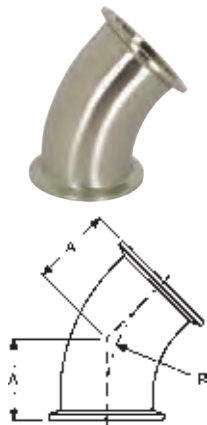

Pipe, Welding & Tube Fittings

90° Clamp x Plain Bevel Seat with Hex Nut Elbows - B2FMP-14

Tube OD	Dimensions		304 Stainless Steel	
	A	B	Part #	Price/E
2"	3.750"	3.500"	B2FMP-14-G200	\$238.27
2 1/2"	4.625"	4.250"	B2FMP-14-G250	285.09
3"	5.406"	5.000"	B2FMP-14-G300	388.84



Clamp Fittings - Tees

Short Outlet Clamp Tees - B7MPS

Pipe, Welding & Tube Fittings

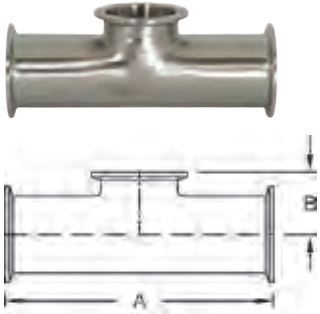

Tube OD	Dimensions		316L Stainless Steel	
	A	B	Part #	Price/E
1½"	5.500"	1.375"	B7MPS-R150	\$284.29
2"	7.000"	1.625"	B7MPS-R200	311.96
2½"	7.000"	1.875"	B7MPS-R250	340.13

Clamp Tees - B7MP

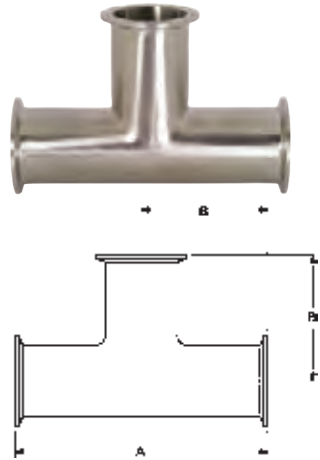

Tube OD	Dimensions		304 Stainless Steel		316L Stainless Steel	
	A	B	Part #	Price/E	Part #	Price/E
½"	4.750"	2.375"	---	---	B7MP-R50	\$135.07
¾"	5.000"	2.500"	---	---	B7MP-R75	133.71
1"	4.750"	2.375"	B7MP-G100	\$75.01	B7MP-R100	84.76
1½"	5.500"	2.750"	B7MP-G150	79.91	B7MP-R150	104.19
2"	7.000"	3.500"	B7MP-G200	88.33	B7MP-R200	122.31
2½"	7.000"	3.500"	B7MP-G250	120.08	B7MP-R250	169.88
3"	7.500"	3.750"	B7MP-G300	166.04	B7MP-R300	235.56
4"	9.000"	4.500"	B7MP-G400	248.01	B7MP-R400	307.69
6"	13.000"	6.500"	B7MP-G600	1223.08	B7MP-R600	1528.85
8"	15.750"	7.875"	B7MP-G800	1993.16	B7MP-R800	2747.26

Clamp Reducing Tees - B7RMP

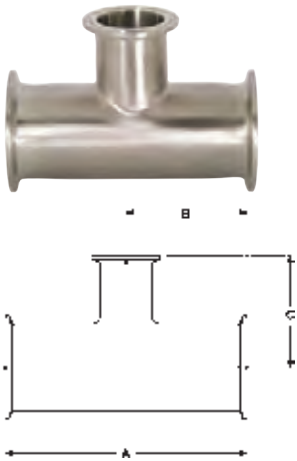

Tube OD	Dimensions			304 Stainless Steel		316L Stainless Steel	
	A	B	C	Part #	Price/E	Part #	Price/E
1" x ¾"	5.250"	2.625"	2.625"	---	---	B7RMP-R10075	\$119.74
1½" x ½"	5.750"	2.875"	2.875"	---	---	B7RMP-R15050	128.36
1½" x 1"	4.312"	2.156"	1.875"	---	---	B7RMP-R150100	185.90
2" x ½"	6.750"	3.375"	3.125"	---	---	B7RMP-R20050	670.44
2" x ¾"	6.750"	3.375"	3.125"	---	---	B7RMP-R20075	723.99
2" x 1"	5.125"	2.562"	2.125"	B7RMP-G200100	\$158.42	B7RMP-R200100	173.56
2" x 1½"	5.125"	2.562"	2.406"	B7RMP-G200150	158.42	B7RMP-R200150	173.56
2½" x 1½"	5.688"	2.844"	2.812"	B7RMP-G250150	195.70	B7RMP-R250150	241.12
2½" x 2"	5.688"	2.844"	2.812"	B7RMP-G250200	195.70	B7RMP-R250200	241.12
3" x 1½"	6.188"	3.093"	2.906"	B7RMP-G300150	271.41	B7RMP-R300150	422.36
3" x 2"	6.188"	3.093"	3.063"	B7RMP-G300200	212.00	B7RMP-R300200	301.69
4" x 1½"	8.125"	4.063"	3.406"	B7RMP-G400150	343.37	---	---
4" x 2"	8.125"	4.063"	3.563"	B7RMP-G400200	387.32	---	---

Clamp Fittings - Reducers

3

Clamp Concentric Reducers - B3114MP

Tube OD	Dimension A	304 Stainless Steel		316L Stainless Steel	
		Part #	Price/E	Part #	Price/E
1" x 1/2"	3.000"	---	---	B3114MP-R10050	\$172.86
1" x 3/4"	2.000"	---	---	B3114MP-R10075	146.77
1 1/2" x 1/2"	5.000"	---	---	B3114MP-R15050	220.16
1 1/2" x 3/4"	4.000"	---	---	B3114MP-R15075	171.24
1 1/2" x 1"	3.000"	B3114MP-G150100	\$69.31	B3114MP-R150100	77.47
2" x 3/4"	6.000"	---	---	B3114MP-R20075	228.30
2" x 1"	5.000"	B3114MP-G200100	88.95	B3114MP-R200100	98.67
2" x 1 1/2"	3.000"	B3114MP-G200150	73.39	B3114MP-R200150	81.55
2 1/2" x 1 1/2"	5.000"	B3114MP-G250150	100.00	B3114MP-R250150	111.19
2 1/2" x 2"	3.000"	B3114MP-G250200	91.33	B3114MP-R250200	101.93
3" x 1 1/2"	7.000"	B3114MP-G300150	163.08	B3114MP-R300150	194.78
3" x 2"	5.000"	B3114MP-G300200	116.38	B3114MP-R300200	138.61
3" x 2 1/2"	3.000"	B3114MP-G300250	110.07	B3114MP-R300250	122.31
4" x 1 1/2"	11.125"	B3114MP-G400150	320.34	B3114MP-R400150	497.39
4" x 2"	9.125"	B3114MP-G400200	217.44	B3114MP-R400200	275.20
4" x 2 1/2"	7.125"	B3114MP-G400250	262.09	B3114MP-R400250	265.00
4" x 3"	5.125"	B3114MP-G400300	144.55	B3114MP-R400300	163.08
6" x 4"	7.000"	B3114MP-G600400	623.07	---	---

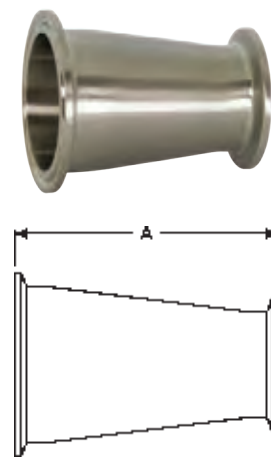

Pipe, Welding & Tube Fittings

Clamp Eccentric Reducers - B3214MP

Tube OD	Dimension A	304 Stainless Steel		316L Stainless Steel	
		Part #	Price/E	Part #	Price/E
1 1/2" x 1"	3.000"	B3214MP-G150100	\$78.27	B3214MP-R150100	\$71.96
2" x 1"	5.000"	B3214MP-G200100	159.59	B3214MP-R200100	231.56
2" x 1 1/2"	3.000"	B3214MP-G200150	83.33	B3214MP-R200150	99.65
2 1/2" x 1 1/2"	5.000"	B3214MP-G250150	122.31	B3214MP-R250150	140.43
2 1/2" x 2"	3.000"	B3214MP-G250200	98.59	B3214MP-R250200	100.14
3" x 1 1/2"	7.000"	B3214MP-G300150	199.32	B3214MP-R300150	203.84
3" x 2"	5.000"	B3214MP-G300200	141.02	B3214MP-R300200	163.08
3" x 2 1/2"	3.000"	B3214MP-G300250	166.14	B3214MP-R300250	168.17
4" x 2"	9.125"	B3214MP-G400200	305.77	B3214MP-R400200	280.85
4" x 2 1/2"	7.125"	B3214MP-G400250	253.68	B3214MP-R400250	258.21
4" x 3"	5.125"	B3214MP-G400300	187.54	B3214MP-R400300	244.62
6" x 3"	6.875"	B3214MP-G600300	931.88	---	---
6" x 4"	7.000"	B3214MP-G600400	1076.49	---	---

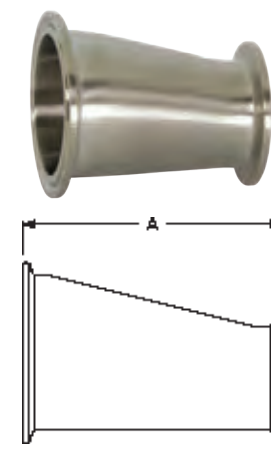

Clamp Crosses

3

Clamp Crosses - B9MP

Tube OD	Dimensions		304 Stainless Steel		316L Stainless Steel	
	A	B	Part #	Price/E	Part #	Price/E
1"	4.750"	2.375"	B9MP-G100	\$220.16	B9MP-R100	\$252.77
1 1/2"	5.500"	2.750"	B9MP-G150	224.55	B9MP-R150	265.81
2"	7.000"	3.500"	B9MP-G200	227.14	B9MP-R200	362.03
3"	7.500"	3.750"	B9MP-G300	396.05	B9MP-R300	652.30
4"	9.000"	4.500"	B9MP-G400	936.54	B9MP-R400	1147.96



Miscellaneous Configurations

Clamp Laterals - B28AMP

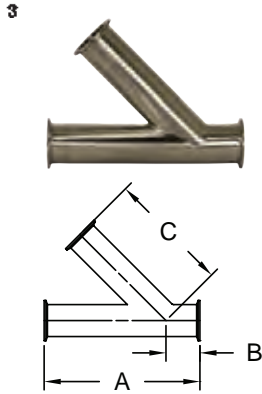

Tube OD	Dimensions			316L Stainless Steel	
	A	B	C	Part #	Price/E
1"	7.000"	1.500"	5.500"	B28AMP-R100	\$472.93
1½"	8.375"	1.688"	6.688"	B28AMP-R150	521.85
2"	9.750"	2.125"	7.625"	B28AMP-R200	524.18
3"	11.750"	2.375"	9.375"	B28AMP-R300	792.08
4"	14.062"	2.640"	11.312"	B28AMP-R400	1728.61

Clamp True Wyes - B28BMP

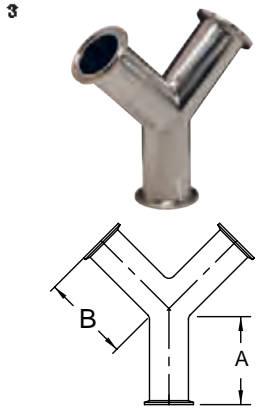

Tube OD	Dimensions		316L Stainless Steel	
	A	B	Part #	Price/E
1"	2.500"	2.938"	B28BMP-R100	\$489.23
1½"	2.500"	2.938"	B28BMP-R150	538.15
2"	3.125"	3.750"	B28BMP-R200	524.18
3"	4.500"	5.375"	B28BMP-R300	886.74
4"	6.000"	6.000"	B28BMP-R400	1281.33

Clamp 180° Return Bends - B2WUMP

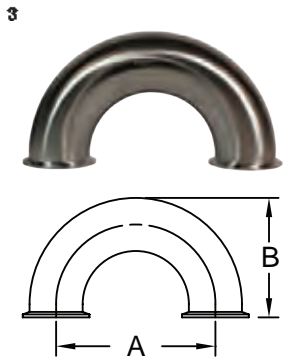

Feature:

- bends are the standard 1.5 x tube diameter

Tube OD	Dimensions		316L Stainless Steel	
	A	B	Part #	Price/E
1"	3.000"	2.500"	B2WUMP-R100	\$206.77
1½"	4.500"	3.500"	B2WUMP-R150	277.23
2"	6.000"	4.500"	B2WUMP-R200	363.46
3"	9.000"	6.500"	B2WUMP-R300	646.16
4"	12.000"	8.625"	B2WUMP-R400	738.45

Clamp End Protection Covers - BCC

Feature:

- Use these covers to protect all clamp ends on fittings, valves, filters and pumps.



Size	Vinyl Plastic	
	Part #	Price/E
½"	BCC-050	\$0.95
¾"	BCC-075	0.95
1"	BCC-100	1.43
1½"	BCC-150	1.43
2"	BCC-200	2.13
2½"	BCC-250	2.49
3"	BCC-300	3.33
4"	BCC-400	4.75
6"	BCC-600	16.61
8"	BCC-800	28.25

Quick Weld Ferrules

Features:

- just slip onto sanitary OD tube and weld
- butt weld is not needed

Tube OD	Dimensions			304 Stainless Steel	
	A	B	C	Part #	Price/E
1"	.290"	1.005"	.870"	14QMP-G100	\$9.85
1½"	.199"	1.505"	1.370"	14QMP-G150	9.85
2"	.205"	2.005"	1.870"	14QMP-G200	12.53
2½"	.210"	2.505"	2.370"	14QMP-G250	15.07
3"	.257"	3.005"	2.870"	14QMP-G300	18.92
4"	.235"	4.005"	3.834"	14QMP-G400	28.85
6"	.321"	6.005"	5.782"	14QMP-G600	74.16

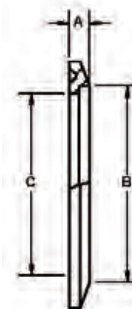

Pipe, Welding & Tube Fittings

Breakaway Coupling - Clamp

Applications:

- Minimizes spillage and damage associated with pull away and drive away incidents

Features:

- designed to be installed between a fixed point and a hose
- coupling breaks away with an excessive load
- EPDM standard clamp gasket
- working pressure: **350 PSI @ 70°F (21°C)**
- 3kN break load bolts standard, other break loads available
- 316 stainless steel polished to standard <math><32R_a</math>, 3A finish
- other sizes, gaskets and connections available, contact Dixon®



Size	316 Stainless Steel	
	Part #	Price/E
3"	SBC-E300CC13	\$718.60



Clamp Gaskets

Features:

- materials approved by 3 (3A), and USDA and comply with FDA's 21CFR177.2600 and 1550
- PSI service ratings for the sanitary clamps DO NOT APPLY to connections (1" and above) using any PTFE gaskets, due to the potential for cold flow under normal operating conditions
- PTFE gaskets, when used with any clamp, are likely to leak at pressures far below the published service ratings. This restriction does not apply to the fractionally sized 1/2" and 3/4" connections, due to their recessed, fully contained design.

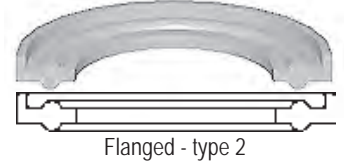
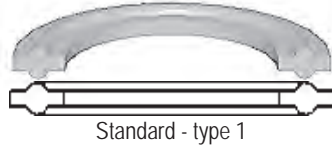

Buna-N Clamp Gaskets - Black

Features:

- color code: red dot
- meets 21CFR 177.2600

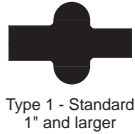
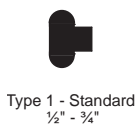

Size	Buna-N	
	Part #	Price/E
1/2"	42MP-U50	\$1.85
3/4"	42MP-U75	2.47
1"	40MP-U100	0.77
1 1/2"	40MP-U150	0.57
2"	40MP-U200	0.64
2 1/2"	40MP-U250	0.97
3"	40MP-U300	1.10
4"	40MP-U400	1.74
5"	40MP-U500	7.44
6"	40MP-U600	9.22
8"	40MP-U800	9.75

Buna-N Clamp Gaskets - White

Features:

- color code: red dot
- meets 21CFR 177.2600

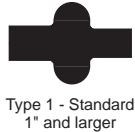
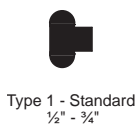

Size	Buna-N	
	Part #	Price/E
1/2"	42MP-UW50	\$2.41
3/4"	42MP-UW75	2.69
1"	40MP-UW100	1.28
1 1/2"	40MP-UW150	1.15
2"	40MP-UW200	1.03
2 1/2"	40MP-UW250	1.41
3"	40MP-UW300	1.54
4"	40MP-UW400	2.51
6"	40MP-UW600	17.43

EPDM Clamp Gaskets - Black

Features:

- color code: three green dots
- peroxide cured
- meets 21CFR 177.2600
- passed USP Class VI Cytotoxicity testing

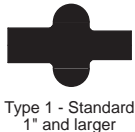
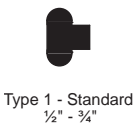

Size	EPDM	
	Part #	Price/E
1/2"	42MP-E50	\$1.74
3/4"	42MP-E75	1.74
1"	40MP-E100	1.03
1 1/2"	40MP-E150	1.15
2"	40MP-E200	1.15
2 1/2"	40MP-E250	1.47
3"	40MP-E300	1.61
4"	40MP-E400	2.11
6"	40MP-E600	10.45

Visit dixonvalve.com for sizing charts

Clamp Gaskets

FKM Clamp Gaskets - Black

Features:

- color code: one white dot, one yellow dot
- peroxide cured
- meets 21CFR 177.2600
- passed USP Class VI Cytotoxicity testing

Size	FKM	
	Part #	Price/E
1/2"	42MP-SFY50	\$5.47
3/4"	42MP-SFY75	6.24
1"	40MP-SFY100	6.29
1 1/2"	40MP-SFY150	4.36
2"	40MP-SFY200	4.54
2 1/2"	40MP-SFY250	8.45
3"	40MP-SFY300	11.16
4"	40MP-SFY400	15.39
6"	40MP-SFY600	53.84

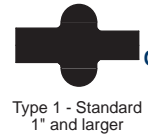
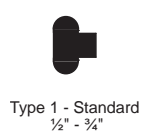

Silicone Clamp Gaskets - White

Features:

- color code: pink dot
- peroxide cured
- meets 21CFR 177.2600
- passed USP Class VI Cytotoxicity testing

Size	Silicone	
	Part #	Price/E
1/2"	42MP-XW50	\$2.87
3/4"	42MP-XW75	3.23
1"	40MP-XW100	3.08
1 1/2"	40MP-XW150	2.56
2"	40MP-XW200	3.00
2 1/2"	40MP-XW250	4.31
3"	40MP-XW300	4.62
4"	40MP-XW400	5.31
6"	40MP-XW600	38.14

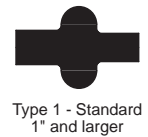
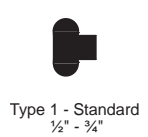

Silicone Clamp Gaskets - Clear

Features:

- color code: no dot
- peroxide cured
- meets 21CFR 177.2600

Size	Silicone	
	Part #	Price/E
1/2"	42MP-XC50	\$2.82
3/4"	42MP-XC75	3.39
1"	40MP-XC100	3.64
1 1/2"	40MP-XC150	4.28
2"	40MP-XC200	3.64
2 1/2"	40MP-XC250	5.06
3"	40MP-XC300	5.41
4"	40MP-XC400	6.47

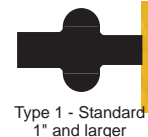
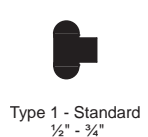

Visit dixonvalve.com for sizing charts

Clamp Gaskets

PTFE Clamp Gaskets - White

Features:

- color code: no dot
- meets 21CFR 177.1550
- passed USP Class VI Cytotoxicity testing
- not recommended for use with bolted clamps

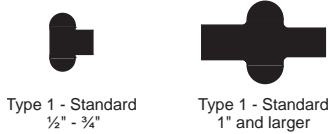

Size	PTFE	
	Part #	Price/E
1/2"	42MP-G50	\$1.77
3/4"	42MP-G75	1.80
1"	40MP-G100	2.23
1 1/2"	40MP-G150	1.97
2"	40MP-G200	2.38
2 1/2"	40MP-G250	3.08
3"	40MP-G300	3.15
4"	40MP-G400	6.39
5"	40MP-G500	65.39
6"	40MP-G600	40.63
8"	40MP-G800	42.94
10"	40MP-G1000	60.62
12"	40MP-G1200	255.19

PTFE is a material subject to plastic flow. When cycled through heat and then cooled down in process lines, PTFE gaskets will not return to the original configuration and it will continue to compress as the cycling continues. This plastic flow will allow leakage if clamp torques are not maintained.



Buna-N Flanged Clamp Gaskets - Black

Features:

- color code: red dot
- meets 21CFR 177.2600
- not recommended for use with bolted clamps

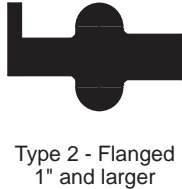

Size	Buna-N	
	Part #	Price/E
1"	40MPF-U100	\$2.03
1 1/2"	40MPF-U150	1.67
2"	40MPF-U200	2.03
2 1/2"	40MPF-U250	2.44
3"	40MPF-U300	3.36
4"	40MPF-U400	4.54
6"	40MPF-U600	25.56
8"	40MPF-U800	22.22
10"	40MPF-U1000	36.83
12"	40MPF-U1200	59.49

Buna-N Flanged Clamp Gaskets - White

Features:

- color code: red dot
- meets 21CFR 177.2600
- not recommended for use with bolted clamps

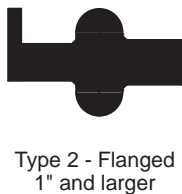

Size	Buna-N	
	Part #	Price/E
1"	40MPF-UW100	\$3.01
1 1/2"	40MPF-UW150	2.31
2"	40MPF-UW200	2.65
2 1/2"	40MPF-UW250	4.75
3"	40MPF-UW300	4.75
4"	40MPF-UW400	6.78
6"	40MPF-UW600	58.74

Visit dixonvalve.com for sizing charts

Clamp Gaskets

EPDM Flanged Clamp Gaskets - Black

Features:

- color code: three green dots
- peroxide cured
- meets 21CFR 177.2600
- passed USP Class VI Cytotoxicity testing
- not recommended for use with bolted clamps

Size	EPDM	
	Part #	Price/E
1"	40MPF-E100	\$3.28
1½"	40MPF-E150	3.28
2"	40MPF-E200	3.85
2½"	40MPF-E250	5.33
3"	40MPF-E300	6.28
4"	40MPF-E400	6.80
6"	40MPF-E600	42.31
8"	40MPF-E800	62.51
10"	40MPF-E1000	76.99
12"	40MPF-E1200	86.28

Type 2 - Flanged
1" and larger

FKM Flanged Clamp Gaskets - Black

Features:

- color code: one white dot, one yellow dot
- peroxide cured
- meets 21CFR 177.2600
- passed USP Class VI Cytotoxicity testing
- not recommended for use with bolted clamps

Size	FKM	
	Part #	Price/E
1"	40MPF-SFY100	\$11.40
1½"	40MPF-SFY150	8.21
2"	40MPF-SFY200	9.81
2½"	40MPF-SFY250	16.42
3"	40MPF-SFY300	18.60
4"	40MPF-SFY400	20.01
6"	40MPF-SFY600	64.80
8"	40MPF-SFY800	100.00
10"	40MPF-SFY1000	130.57
12"	40MPF-SFY1200	168.65

Type 2 - Flanged
1" and larger

Silicone Flanged Clamp Gaskets - White

Features:

- color code: pink dot
- peroxide cured
- meets 21CFR 177.2600
- passed USP Class VI Cytotoxicity testing
- not recommended for use with bolted clamps

Size	Silicone	
	Part #	Price/E
1"	40MPF-XW100	\$5.06
1½"	40MPF-XW150	4.75
2"	40MPF-XW200	4.62
2½"	40MPF-XW250	6.23
3"	40MPF-XW300	7.24
4"	40MPF-XW400	9.88
6"	40MPF-XW600	51.28
8"	40MPF-XW800	60.90
10"	40MPF-XW1000	65.70
12"	40MPF-XW1200	70.52

Type 2 - Flanged
1" and largerVisit dixonvalve.com for sizing charts

Clamp Gaskets

Buna-N Mesh Screen Clamp Gasket, 316

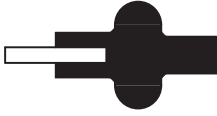

Type 3 - Mesh

Features:

- color code: red dot
- meets 21CFR 177.2600
- 10 mesh standard, other mesh available-call for details

Size	Buna-N	
	Part #	Price/E
1"	40MPS-U100	\$52.30
1½"	40MPS-U150	41.96
2"	40MPS-U200	42.67
2½"	40MPS-U250	57.69
3"	40MPS-U300	65.39
4"	40MPS-U400	100.96

PTFE Envelope Clamp Gaskets with EPDM Filler

Features:

- color code: usually not marked
- peroxide cured EPDM
- meets 21CFR 177.1550
- PTFE passed USP Class VI Cytotoxicity testing

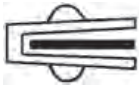

Size	PTFE with EPDM Filler	
	Part #	Price/E
½"	42MP-GRE50	\$17.06
1"	40MP-GRE100	9.42
1½"	40MP-GRE150	8.01
2"	40MP-GRE200	7.11
2½"	40MP-GRE250	10.83
3"	40MP-GRE300	10.67
4"	40MP-GRE400	22.56
6"	40MP-GRE600	71.22

PTFE Envelope Clamp Gaskets with FKM Filler

Features:

- color code: FKM usually not marked
- peroxide cured FKM
- meets 21CFR 177.1550
- PTFE passed USP Class VI Cytotoxicity testing

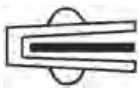

Size	PTFE with FKM Filler	
	Part #	Price/E
1"	40MP-GR100	\$9.16
1½"	40MP-GR150	8.01
2"	40MP-GR200	9.68
2½"	40MP-GR250	10.26
3"	40MP-GR300	11.73
4"	40MP-GR400	21.99
6"	40MP-GR600	74.75

PTFE is a material subject to plastic flow. When cycled through heat and then cooled down in process lines, PTFE gaskets will not return to the original configuration and it will continue to compress as the cycling continues. This plastic flow will allow leakage if clamp torques are not maintained.



Visit dixonvalve.com for sizing charts

Metal Detectable Clamp Gaskets

Feature:

- impregnated with stainless steel particles allowing a gasket or gasket pieces to be found with metal detection equipment

Buna-N Metal Detectable Clamp Gaskets

Features:

- good general use where temperature extremes do not exist
- minimum temperature: **-20°F (-29°C)**
- maximum temperature: **212°F (100°C)**

Size	Buna-N	
	Part #	Price/E
1"	40MP-UZ100	\$3.64
1½"	40MP-UZ150	3.52
2"	40MP-UZ200	3.59
2½"	40MP-UZ250	5.85
3"	40MP-UZ300	6.46
4"	40MP-UZ400	7.05

Type 1 - Standard
1" and larger

EPDM Metal Detectable Clamp Gaskets

Features:

- resistant to steam, water and base solutions
- minimum temperature: **-70°F (-57°C)**
- maximum temperature: **310°F (154°C)**

Size	EPDM	
	Part #	Price/E
1"	40MP-EZ100	\$5.08
1½"	40MP-EZ150	4.92
2"	40MP-EZ200	5.16
2½"	40MP-EZ250	6.77
3"	40MP-EZ300	7.13
4"	40MP-EZ400	9.93

Type 1 - Standard
1" and larger

FKM Metal Detectable Clamp Gaskets

Features:

- resistant to steam, heat and high acid solutions
- minimum temperature: **-20°F (-29°C)**
- maximum temperature: **410°F (410°C)**

Size	FKM	
	Part #	Price/E
1"	40MP-SFYZ100	\$11.40
1½"	40MP-SFYZ150	11.53
2"	40MP-SFYZ200	9.85
2½"	40MP-SFYZ250	19.37
3"	40MP-SFYZ300	20.38
4"	40MP-SFYZ400	31.28

Type 1 - Standard
1" and largerVisit dixonvalve.com for sizing charts

Cam and Groove Transition Fittings ¹

Cam and Groove Adapter x Clamp End



Size	316 Stainless Steel	
	Part #	Price/E
1½"	RE150SE	\$162.75
2"	RE200SE	180.00
3"	RE300SE	378.00

Cam and Groove Coupler x Clamp End



Size	316 Stainless Steel	
	Part #	Price/E
1½"	RC150SE	\$270.00
2"	RC200SE	310.50
3"	RC300SE	490.00

Dixon® Weld to Tube Cam and Groove ¹

Features:

- designed to be welded to standard sanitary tubing
- 316 stainless steel investment casting

Cam and Groove Adapter x Weld to Tube End



Size	316 Stainless Steel	
	Part #	Price/E
1"	RE100BT	\$130.00
1½"	RE150BT	147.30
2"	RE200BT	169.15
3"	RE300BT	357.00

Boss-Lock™ Coupler x Weld to Tube End



Size	316 Stainless Steel	
	Part #	Price/E
1"	RC100BT	\$195.00
1½"	RC150BT	240.00
2"	RC200BT	260.00
3"	RC300BT	425.00

¹ for all other cam and groove options see section D

European Fittings

DIN 11851 Round Nuts - 13R

Tube OD	DN Size	Dimensions			304 Stainless Steel	
		A	B	C	Part #	Price/E
1"	25	.83"	2.48"	2.05"	13R-G100DIN	\$34.56
1½"	40	.83"	3.07"	2.43"	13R-G150DIN	43.08
2"	50	.87"	3.62"	3.07"	13R-G200DIN	55.10
2½"	65	.98"	4.41"	3.74"	13R-G250DIN	74.66
3"	80	1.14"	5.00"	4.33"	13R-G300DIN	114.69
4"	100	1.22"	5.83"	5.12"	13R-G400DIN	133.81

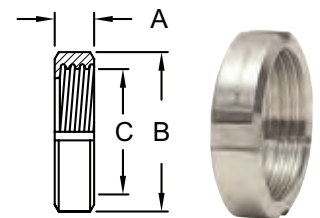

Pipe, Welding & Tube Fittings

DIN Blank Caps - 16AMP

Tube OD	DN Size	Dimensions				316 Stainless Steel	
		A	B	C	D	Part #	Price/E
1"	25	.51"	1.73"	.39"	1.38"	16AMP-R100DIN	\$28.17
1½"	40	.51"	2.20"	.39"	1.89"	16AMP-R150DIN	44.70
2"	50	.55"	2.68"	.43"	2.40"	16AMP-R200DIN	63.72
2½"	65	.63"	3.39"	.47"	3.11"	16AMP-R250DIN	112.99
3"	80	.63"	3.94"	.47"	3.66"	16AMP-R300DIN	139.37
4"	100	.79"	4.76"	.59"	4.49"	16AMP-R400DIN	231.99

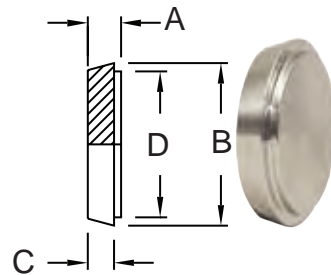

DIN Welding Males - 15A

Tube OD	DN Size	Dimensions		316 Stainless Steel	
		A	B	Part #	Price/E
1"	25	1.14"	2.04"	15A-R100DIN	\$32.67
1½"	40	1.30"	2.55"	15A-R150DIN	45.50
2"	50	1.38"	3.07"	15A-R200DIN	55.53
2½"	65	1.57"	3.74"	15A-R250DIN	88.31
3"	80	1.77"	4.31"	15A-R300DIN	135.09
4"	100	2.13"	5.12"	15A-R400DIN	155.08

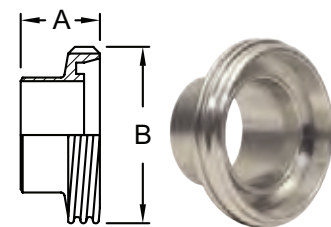

DIN Welding Liners - 14A

Tube OD	DN Size	Dimensions		316 Stainless Steel	
		A	B	Part #	Price/E
1"	25	.87"	1.73"	14A-R100DIN	\$22.71
1½"	40	1.02"	2.20"	14A-R150DIN	31.95
2"	50	1.10"	2.68"	14A-R200DIN	40.83
2½"	65	1.26"	3.39"	14A-R250DIN	70.18
3"	80	1.46"	3.94"	14A-R300DIN	97.55
4"	100	1.73"	4.76"	14A-R400DIN	124.29

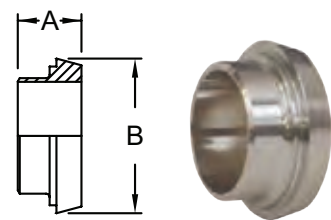

DIN Buna-N European Gaskets - Black

Features:

- color code: red dot
- meets 21CFR 177.2600

Tube OD	DN Size	ID	OD	Height	DIN 11851 Buna-N	
					Part #	Price/E
1"	25	1.18"	1.57"	.20"	40MP-U100DIN	\$1.82
1½"	40	1.65"	2.05"	.20"	40MP-U150DIN	2.31
2"	50	2.13"	2.52"	.20"	40MP-U200DIN	2.80
2½"	65	2.80"	3.19"	.20"	40MP-U250DIN	3.62
3"	80	3.35"	3.74"	.20"	40MP-U300DIN	4.28
4"	100	4.09"	4.49"	.24"	40MP-U400DIN	5.93

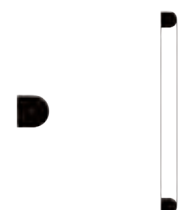

European Fittings SMS

SMS Round Nuts - 13R

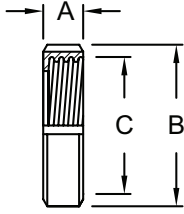

Tube OD	DN Size	Dimensions			304 Stainless Steel	
		A	B	C	Part #	Price/E
1"	25.0	.75"	2.01"	1.57"	13R-G100SMS	\$22.53
1½"	38.0	.91"	2.91"	2.36"	13R-G150SMS	33.92
2"	51.0	.94"	3.31"	2.76"	13R-G200SMS	40.45
2½"	63.5	1.10"	3.94"	3.35"	13R-G250SMS	56.84
3"	76.0	1.18"	4.49"	3.86"	13R-G300SMS	71.40
4"	101.6	1.22"	5.43"	4.92"	13R-G400SMS	80.33

SMS Blank Caps - 16AMP

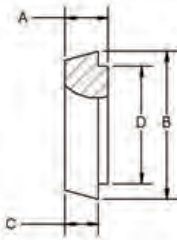

Tube OD	DN Size	Dimensions				316 Stainless Steel	
		A	B	C	D	Part #	Price/E
1"	25	.30"	1.40"	.14"	1.25"	16AMP-R100SMS	\$14.63
1½"	38	.31"	2.20"	.16"	1.89"	16AMP-R150SMS	24.97
2"	51	.35"	2.56"	.16"	2.38"	16AMP-R200SMS	36.34
2½"	63.5	.35"	3.15"	.16"	2.89"	16AMP-R250SMS	52.23
3"	76	.43"	3.66"	.20"	3.41"	16AMP-R300SMS	85.90
4"	101.6	.43"	4.65"	.23"	4.43"	16AMP-R400SMS	110.51

SMS Welding Males - 15A

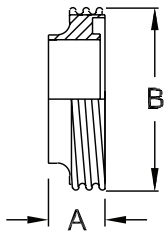

Tube OD	DN Size	Dimensions		316 Stainless Steel	
		A	B	Part #	Price/E
1"	25.0	.75"	1.57"	15A-R100SMS	\$16.63
1½"	38.0	.91"	2.36"	15A-R150SMS	33.28
2"	51.0	.91"	2.76"	15A-R200SMS	45.06
2½"	63.5	1.06"	3.35"	15A-R250SMS	62.02
3"	76.0	1.06"	3.86"	15A-R300SMS	71.62
4"	101.6	1.18"	4.92"	15A-R400SMS	104.11

SMS Welding Liners - 14A

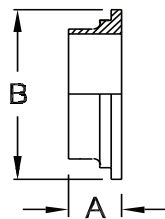

Tube OD	DN Size	Dimensions		316 Stainless Steel	
		A	B	Part #	Price/E
1"	25	.61"	1.40"	14A-R100SMS	\$10.94
1½"	38	.63"	2.17"	14A-R150SMS	15.43
2"	51	.67"	2.56"	14A-R200SMS	19.22
2½"	63.5	.67"	3.16"	14A-R250SMS	25.04
3"	76	.75"	3.66"	14A-R300SMS	34.36
4"	101.6	.75"	4.65"	14A-R400SMS	45.06

SMS Buna-N European Gaskets - Black

Features:

- color code: red dot
- meets 21CFR 177.2600

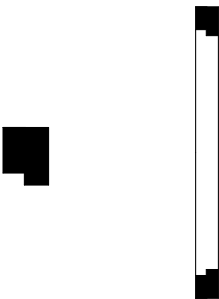

Tube OD	DN Size	ID	OD	L Style Buna-N	
				Part #	Price/E
1"	25	.98"	1.26"	40MP-U100SMS	\$1.23
1½"	38	1.49"	1.89"	40MP-U150SMS	2.31
2"	51	2.00"	2.40"	40MP-U200SMS	2.41
2½"	63.5	2.50"	2.89"	40MP-U250SMS	2.69
3"	76	2.99"	3.39"	40MP-U300SMS	4.75
4"	101.6	4.09"	4.49"	40MP-U400SMS	7.59

European Fittings

RJT BS: 4825

RJT Hex Nuts - 13H

Tube OD	Dimensions		304 Stainless Steel	
	A	B	Part #	Price/E
1"	.87"	2.00"	13H-G100RJT	\$24.68
1½"	.87"	2.56"	13H-G150RJT	33.11
2"	.87"	3.12"	13H-G200RJT	43.08
2½"	.87"	3.62"	13H-G250RJT	53.84
3"	.87"	4.12"	13H-G300RJT	62.11
4"	.87"	5.12"	13H-G400RJT	81.30

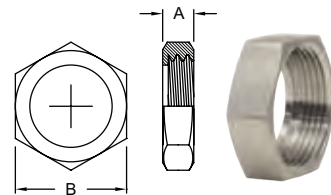

Pipe, Welding & Tube Fittings

RJT Blank Caps - 13RBN

Tube OD	Dimensions		304 Stainless Steel	
	A	B	Part #	Price/E
1"	.32"	1.63"	13RBN-G100RJT	\$14.03
1½"	.32"	2.12"	13RBN-G150RJT	20.04
2"	.32"	2.62"	13RBN-G200RJT	32.85
2½"	.32"	3.12"	13RBN-G250RJT	38.13
3"	.32"	3.63"	13RBN-G300RJT	64.62
4"	.32"	4.63"	13RBN-G400RJT	56.38

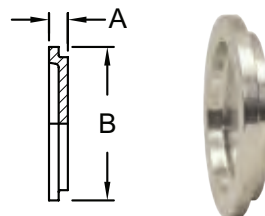

RJT Welding Males - 15A

Tube OD	Dimension		316 Stainless Steel	
	A	B	Part #	Price/E
1"	1.06"	1.80"	15A-R100RJT	\$31.05
1½"	1.06"	2.30"	15A-R150RJT	40.39
2"	1.06"	2.86"	15A-R200RJT	52.68
2½"	1.06"	3.36"	15A-R250RJT	61.66
3"	1.06"	3.86"	15A-R300RJT	62.59
4"	1.06"	4.86"	15A-R400RJT	105.99

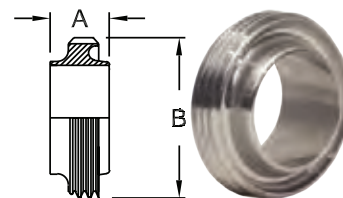

RJT Welding Liners - 14A

Tube OD	Dimensions		316 Stainless Steel	
	A	B	Part #	Price/E
1"	.77"	1.63"	14A-R100RJT	\$19.87
1½"	.77"	2.13"	14A-R150RJT	22.53
2"	.77"	2.63"	14A-R200RJT	28.54
2½"	.77"	3.13"	14A-R250RJT	38.95
3"	.77"	3.63"	14A-R300RJT	37.00
4"	.77"	4.63"	14A-R400RJT	66.72

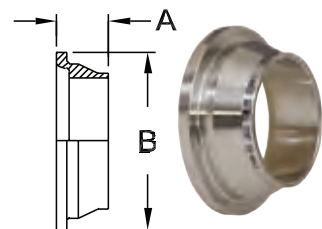

RJT Spanner Wrenches - SP

Tube OD	Dimensions		Aluminum	
	A	B	Part #	Price/E
1"	10.00"	2.00"	RJT-100SP	\$99.34
1½"	11.50"	2.56"	RJT-150SP	102.90
2"	12.00"	3.12"	RJT-200SP	126.16
2½"	13.50"	3.62"	RJT-250SP	169.61
3"	14.50"	4.12"	RJT-300SP	235.37
4"	17.50"	5.12"	RJT-400SP	214.03

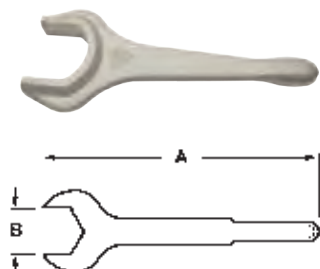

European Fittings

RJT Buna-N European Gaskets - Black

Pipe, Welding
& Tube Fittings



Features:

- color code: red dot
- meets 21CFR 177.2600

Tube OD	ID	Diameter	Buna-N	
			Part #	Price/E
1"	1.06"	.25"	40MP-U100RJT	\$2.15
1½"	1.56"	.25"	40MP-U150RJT	2.64
2"	2.06"	.25"	40MP-U200RJT	3.62
2½"	2.56"	.25"	40MP-U250RJT	4.28
3"	3.06"	.25"	40MP-U300RJT	4.60
4"	4.06"	.25"	40MP-U400RJT	6.91

DIN and SMS Spanner Wrenches - SP

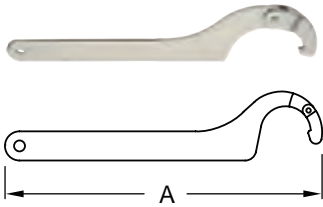

Used On	DN Size	Dimension A	Nickel Plated Steel	
			Part #	Price/E
1" - 1½"	25-40	9.75"	DIN-SMS-60/90SP	\$223.29
2" - 4"	50-101.6	13.00"	DIN-SMS90/155SP	591.67



Bevel Seat Union Hex Nuts - 13H

Feature:

- maximum operating pressure: **400 PSI**

Tube OD	Dimensions		304 Stainless Steel (CF8)	Price/E
	A	B	Part #	
1"	.906"	1.812"	13H-G100	\$17.17
1½"	.968"	2.406"	13H-G150	26.17
2"	1.062"	3.000"	13H-G200	29.89
2½"	1.187"	3.594"	13H-G250	47.50
3"	1.281"	4.188"	13H-G300	51.61
4"	1.500"	5.438"	13H-G400	101.19

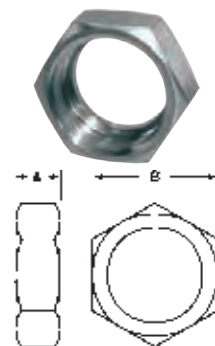

Pipe, Welding & Tube Fittings

Bevel Seat Hex Wrenches

Single Sided Hex Wrenches - 25H

Tube OD	Dimensions		Aluminum	Price/E
	A	B	Part #	
1"	10.500"	1.812"	25H-100	\$49.68
1½"	12.000"	2.406"	25H-150	51.45
2"	14.000"	3.000"	25H-200	63.08
2½"	16.250"	3.594"	25H-250	94.23
3"	18.500"	4.188"	25H-300	130.75
4"	19.500"	5.438"	25H-400	166.47

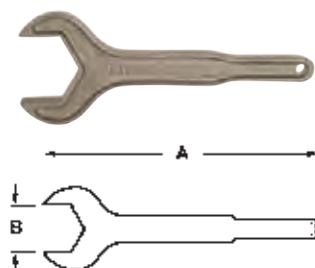

Two Sided Hex Wrenches - 25H

Tube OD	Dimensions			Aluminum	Price/E
	A	B	C	Part #	
1½" x 1"	12.000"	2.406"	1.812"	25H-150100	\$93.13
2" x 1½"	14.000"	3.000"	2.406"	25H-200150	103.86
2½" x 2"	16.500"	3.594"	3.000"	25H-250200	125.44
3" x 2"	18.000"	4.188"	3.000"	25H-300200	154.62
3" x 2½"	18.000"	4.188"	3.594"	25H-300250	167.02

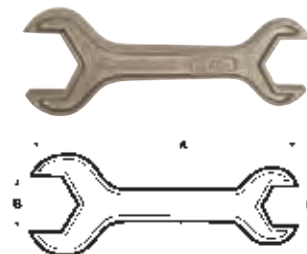

Bevel Seat Ferrules

Short Plain Bevel Seat Weld Ferrules - 14PRF

3

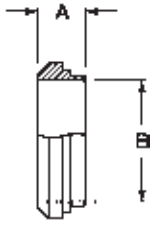

Tube OD	Dimensions		304 Stainless Steel	
	A	B	Part #	Price/E
1"	.718"	.870"	14PRF-G100	\$8.96
1½"	.718"	1.370"	14PRF-G150	11.21
2"	.750"	1.870"	14PRF-G200	13.04
2½"	.875"	2.370"	14PRF-G250	22.82
3"	.906"	2.870"	14PRF-G300	27.05
4"	1.031"	3.834"	14PRF-G400	47.37

Long Plain Bevel Seat Weld Ferrules - 14A

3

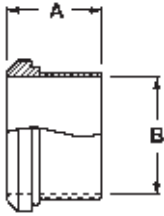

Tube OD	Dimensions		304 Stainless Steel	
	A	B	Part #	Price/E
1"	1.375"	.870"	14A-G100	\$13.22
1½"	1.500"	1.370"	14A-G150	15.34
2"	1.500"	1.870"	14A-G200	17.53
2½"	1.750"	2.370"	14A-G250	28.35
3"	1.750"	2.870"	14A-G300	38.19
4"	1.750"	3.834"	14A-G400	60.85

Recessless Plain Bevel Seat Ferrules for Expanding - 14R

3¹

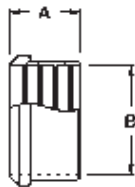

Tube OD	Dimensions		304 Stainless Steel	
	A	B	Part #	Price/E
1½"	1.125"	1.505"	14R-G150	\$17.17
2"	1.312"	2.005"	14R-G200	22.37
2½"	1.375"	2.505"	14R-G250	29.84
3"	1.437"	3.005"	14R-G300	37.80
4"	1.500"	4.005"	14R-G400	61.33

¹ Meets 3-A Standard Number 63-03 when used to modify or repair existing on-site farm milk handling systems.

Short Threaded Bevel Seat Weld Ferrules - 15TRF

3

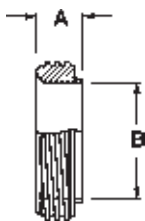

Tube OD	Dimensions		304 Stainless Steel	
	A	B	Part #	Price/E
1"	.718"	.870"	15TRF-G100	\$12.16
1½"	.718"	1.370"	15TRF-G150	12.70
2"	.750"	1.870"	15TRF-G200	17.61
2½"	.875"	2.370"	15TRF-G250	25.66
3"	.906"	2.870"	15TRF-G300	34.00
4"	1.031"	3.834"	15TRF-G400	54.97

Bevel Seat Ferrules

Long Threaded Bevel Seat Weld Ferrules - 15A

Tube OD	Dimensions		304 Stainless Steel	
	A	B	Part #	Price/E
1"	1.375"	.870"	15A-G100	\$18.43
1½"	1.500"	1.370"	15A-G150	24.99
2"	1.500"	1.870"	15A-G200	30.57
2½"	1.750"	2.370"	15A-G250	44.47
3"	1.750"	2.870"	15A-G300	58.41
4"	1.750"	3.834"	15A-G400	87.74

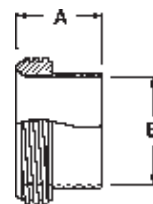

Pipe, Welding & Tube Fittings

Recessless Threaded Bevel Seat Ferrules for Expanding - 15R

Tube OD	Dimensions		304 Stainless Steel	
	A	B	Part #	Price/E
1	.812"	1.005"	15R-G100	\$20.89
1½"	1.125"	1.505"	15R-G150	24.13
2"	1.375"	2.005"	15R-G200	31.51
2½"	1.500"	2.505"	15R-G250	55.66
3"	1.625"	3.005"	15R-G300	49.81
4"	1.675"	4.005"	15R-G400	79.24

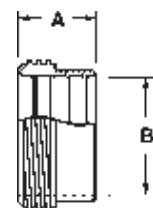

¹ Meets 3-A Standard Number 63-03 when used to modify or repair existing on-site farm milk handling systems.

Bevel Seat End Caps

Plain Bevel Seat Solid End Caps - 16A

Tube OD	Dimension A	304 Stainless Steel	
	A	Part #	Price/E
1"	1.312"	16A-G100	\$8.42
1½"	1.843"	16A-G150	13.60
2"	2.375"	16A-G200	20.07
2½"	2.906"	16A-G250	27.12
3"	3.437"	16A-G300	40.88
4"	4.500"	16A-G400	71.36



Bevel Seat Adapters

Plain Bevel Seat x Male NPT Adapters with Hex Nut - 14-19

Tube OD	Dimension A	304 Stainless Steel	
	A	Part #	Price/E
1½"	3.250"	14-19-G150	\$219.29
2"	3.312"	14-19-G200	207.12
3"	4.250"	14-19-G300	338.54

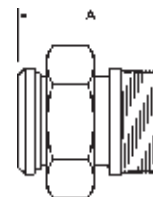

Bevel Seat Elbows

Threaded Bevel Seat x Plain Bevel Seat with Hex Nut 90° Elbows - B2F



Tube OD	Dimension A	304 Stainless Steel	
		Part #	Price/E
1½"	2.968"	B2F-G150	\$170.50
2"	3.750"	B2F-G200	194.73
2½"	4.625"	B2F-G250	244.95
3"	5.406"	B2F-G300	308.03

Plain Bevel Seat x Plain Bevel Seat with Hex Nut 90° Elbows - B2E

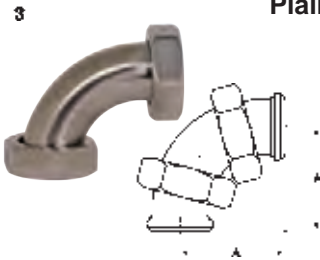

Tube OD	Dimension A	304 Stainless Steel	
		Part #	Price/E
1½"	2.968"	B2E-G150	\$241.67
2"	3.750"	B2E-G200	287.81
2½"	4.625"	B2E-G250	269.69
3"	5.406"	B2E-G300	354.56

Bevel Seat Reducers

Plain Bevel Seat x Threaded Bevel Seat Concentric Reducers - B3115F

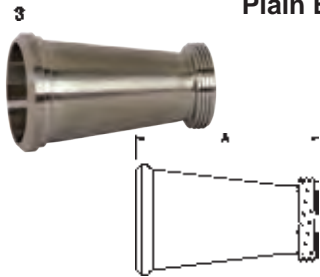

Tube OD	Dimension A	304 Stainless Steel	
		Part #	Price/E
2" x 1½"	3.468"	B3115F-G200150	\$169.20
2½" x 2"	3.625"	B3115F-G250200	168.93
3" x 2"	5.656"	B3115F-G300200	225.39
3" x 2½"	3.781"	B3115F-G300250	195.73
4" x 3"	5.937"	B3115F-G400300	303.53

Threaded Bevel Seat x Plain Bevel Seat with Hex Nut Concentric Reducers - B31TP

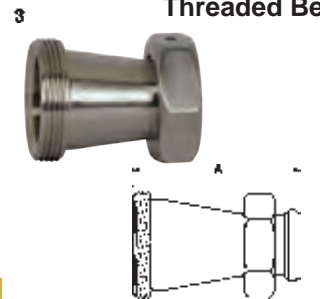

Tube OD	Dimension A	304 Stainless Steel	
		Part #	Price/E
2" x 1½"	3.468"	B31TP-G200150	\$194.65
2½" x 2"	3.625"	B31TP-G250200	219.16
3" x 2"	5.656"	B31TP-G300200	264.12
3" x 2½"	3.781"	B31TP-G300250	214.56
4" x 3"	5.937"	B31TP-G400300	381.09

Breakaway Coupling - Bevel Seat

Applications:

- minimizes spillage and damage associated with pull away and drive away incidents

Features:

- designed to be installed between a fixed point and a hose
- coupling breaks away with an excessive load
- bevel seat connection standard
- EPDM standard clamp gasket
- working pressure: **350 PSI @ 70°F (21°C)**
- 13kN break load bolts standard, other break loads available
- 316 stainless steel polished to standard <math><32R_a</math>, 3A finish
- other sizes, gaskets and connections available, contact Dixon®
- other connection styles available



Size	316 Stainless Steel	
	Part #	Price/E
3"	SBC-E300TP13	\$878.38

Bevel Seat Gaskets

Buna-N Bevel Seat Gaskets - Black

Features:

- color code: red dot
- meets 21CFR 177.2600

Size	Part #	Buna-N	Price/E
1"	40BS-O100		\$1.74
1½"	40BS-O150		1.28
2"	40BS-O200		1.28
2½"	40BS-O250		2.44
3"	40BS-O300		3.01
4"	40BS-O400		5.33

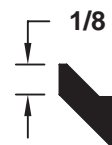

PTFE Bevel Seat Gaskets - White

Features:

- color code: no dot
- meets 21CFR 177.1550
- passed USP Class VI Cytotoxicity testing

Size	Part #	PTFE	Price/E
1"	40BS-S100		\$3.77
1½"	40BS-S150		3.00
2"	40BS-S200		3.59
2½"	40BS-S250		4.54
3"	40BS-S300		5.73
4"	40BS-S400		11.39

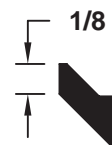

Heavy PTFE Bevel Seat Gaskets - White

Features:

- color code: no dot
- meets 21CFR 177.1550
- passed USP Class VI Cytotoxicity testing

Size	Part #	PTFE	Price/E
1"	40BS-H100		\$3.96
1½"	40BS-H150		5.26
2"	40BS-H200		5.39
2½"	40BS-H250		9.42
3"	40BS-H300		8.52
4"	40BS-H400		15.39

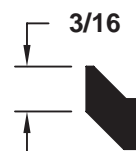

PTFE is a material subject to plastic flow. When cycled through heat and then cooled down in process lines, PTFE gaskets will not return to the original configuration and it will continue to compress as the cycling continues. This plastic flow will allow leakage if clamp torques are not maintained.



Visit dixonvalve.com for sizing charts

I-Line / Q-Line Clamps

Heavy Duty Clamps - 13ILH



Tube OD	Service Pressure PSI Rating @ 70°F (21°C) ¹	Service Pressure PSI Rating @ 250°F (121°C) ¹	Dimension A	304 Stainless Steel	
				Part #	Price/E
1" - 1½"	700	250	2.122"	13ILH100-150	\$27.54
2"	450	250	2.654"	13ILH200	33.83
2½"	450	200	3.185"	13ILH250	47.60
3"	350	150	3.717"	13ILH300	57.10
4"	200	125	4.820"	13ILH400	67.18
6"	150	100	7.689"	13ILH600	141.56
8"	125	75	9.689"	13ILH800	184.23

¹ wing nut tightened to 25 in. lbs. of torque

Bolted Clamps - 13ILB

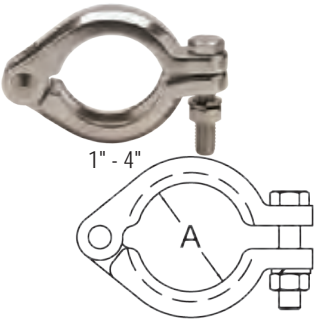

Tube OD	Service Pressure PSI Rating @ 70°F (21°C) ¹	Service Pressure PSI Rating @ 250°F (121°C) ¹	Dimension A	304 Stainless Steel	
				Part #	Price/E
1" - 1½"	1220	1100	2.122"	13ILB100-150	\$31.62
2"	900	830	2.654"	13ILB200	53.50
2½"	720	660	3.185"	13ILB250	75.04
3"	600	550	3.717"	13ILB300	105.99
4"	570	525	4.820"	13ILB400	128.05

¹ nut tightened to 20 ft. lbs. of torque

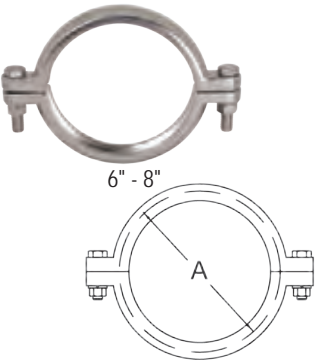

Tube OD	Service Pressure PSI Rating @ 70°F (21°C) ¹	Service Pressure PSI Rating @ 250°F (121°C) ¹	Dimension A	304 Stainless Steel	
				Part #	Price/E
6"	300	200	7.689"	13ILB600	\$197.84
8"	250	150	9.689"	13ILB800	397.20

¹ nut tightened to 20 ft. lbs. of torque

Q-Line Clamps

Heavy Duty Clamps - 13QLH¹

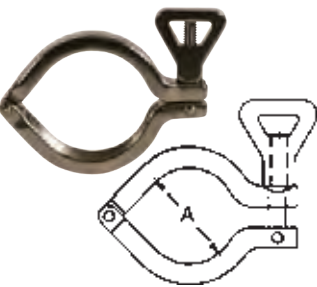

Tube OD	Dimension A	304 Stainless Steel	
		Part #	Price/E
1" - 1½"	2.122"	13QLH100-150	\$27.54
2"	2.654"	13QLH200	33.83
2½"	3.185"	13QLH250	47.60
3"	3.717"	13QLH300	57.10
4"	4.820"	13QLH400	67.18

¹ wing nut tightened to 25 in. lbs. of torque

Ferrules

Male I-Line Short Weld Ferrules - 14WI

Tube OD	Dimension A	304 Stainless Steel		316L Stainless Steel	
		Part #	Price/E	Part #	Price/E
1"	.600"	14WI-G100	\$14.35	14WI-R100	\$18.35
1½"	.765"	14WI-G150	14.35	14WI-R150	18.35
2"	.790"	14WI-G200	20.89	14WI-R200	25.97
2½"	.848"	14WI-G250	31.69	14WI-R250	41.54
3"	.906"	14WI-G300	45.89	14WI-R300	59.74
4"	1.031"	14WI-G400	71.94	14WI-R400	94.31
6"	.940"	---	---	14WI-R600	345.76
8"	.940"	---	---	14WI-R800	551.77

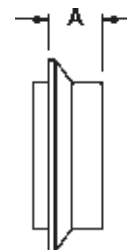

3
Pipe, Welding
& Tube Fittings

Male I-Line Long Weld Ferrules - 14WLI

Tube OD	Dimension A	304 Stainless Steel		316L Stainless Steel	
		Part #	Price/E	Part #	Price/E
1"	1.562"	14WLI-G100	\$42.21	14WLI-R100	\$52.63
1½"	1.843"	14WLI-G150	42.73	14WLI-R150	143.45
2"	2.062"	14WLI-G200	51.64	14WLI-R200	230.78
2½"	2.188"	14WLI-G250	77.60	14WLI-R250	210.13
3"	2.375"	14WLI-G300	102.81	14WLI-R300	345.47
4"	2.688"	14WLI-G400	140.20	14WLI-R400	168.75
6"	2.688"	---	---	14WLI-R600	1877.51

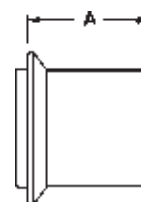

3

Female I-line Short Weld Ferrules - 15WI

Tube OD	Dimension A	304 Stainless Steel		316L Stainless Steel	
		Part #	Price/E	Part #	Price/E
1"	.785"	15WI-G100	\$14.84	15WI-R100	\$18.69
1½"	.950"	15WI-G150	14.84	15WI-R150	18.69
2"	1.040"	15WI-G200	23.51	15WI-R200	29.23
2½"	1.160"	15WI-G250	33.59	15WI-R250	49.19
3"	1.220"	15WI-G300	46.78	15WI-R300	60.71
4"	1.350"	15WI-G400	73.19	15WI-R400	95.54
6"	1.125"	---	---	15WI-R600	345.76
8"	1.125"	---	---	15WI-R800	505.78



3

Female I-Line Long Weld Ferrules - 15WLI

Tube OD	Dimension A	304 Stainless Steel		316L Stainless Steel	
		Part #	Price/E	Part #	Price/E
1"	1.750"	15WLI-G100	\$42.21	15WLI-R100	\$63.14
1½"	2.031"	15WLI-G150	42.73	15WLI-R150	74.19
2"	2.312"	15WLI-G200	52.14	15WLI-R200	226.03
2½"	2.500"	15WLI-G250	71.13	15WLI-R250	350.63
3"	2.688"	15WLI-G300	96.98	15WLI-R300	470.48
4"	3.000"	15WLI-G400	140.20	15WLI-R400	600.99
6"	3.000"	---	---	15WLI-R600	1692.29

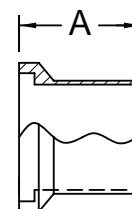

3



Ferrules

Q-line Weld Ferrules - 14WQ

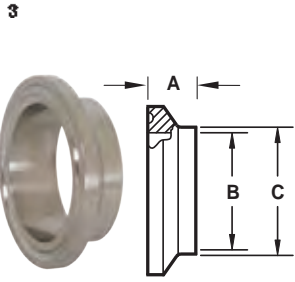

Tube OD	Dimensions			304 Stainless Steel	
	A	B	C	Part #	Price/E
1"	.531"	.870"	1.000"	14WQ-G100	\$50.48
1½"	.563"	1.370"	1.500"	14WQ-G150	43.08
2"	.813"	1.870"	2.000"	14WQ-G200	78.07
2½"	.938"	2.370"	2.500"	14WQ-G250	91.79
3"	.938"	2.870"	3.000"	14WQ-G300	168.24
4"	1.000"	3.834"	4.000"	14WQ-G400	264.23

End Caps

Male I-line Solid End Caps - 16AI-14I

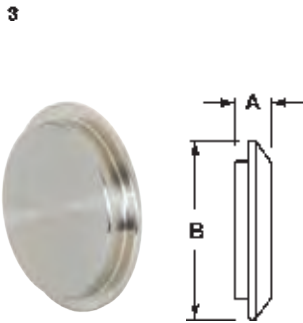

Tube OD	Dimensions		304 Stainless Steel		316L Stainless Steel	
	A	B	Part #	Price/E	Part #	Price/E
1"	.500"	1.985"	16AI-14I100	\$16.89	16AI-14I100R	\$57.26
1½"	.500"	1.985"	16AI-14I150	16.89	16AI-14I150R	57.26
2"	.562"	2.640"	16AI-14I200	25.84	16AI-14I200R	83.38
2½"	.750"	3.307"	16AI-14I250	43.27	16AI-14I250R	64.05
3"	.750"	3.870"	16AI-14I300	56.26	16AI-14I300R	186.62
4"	.750"	4.870"	16AI-14I400	96.33	16AI-14I400R	288.47
6"	.750"	7.495"	---	---	16AI-14I600R	1195.00
8"	.880"	9.495"	---	---	16AI-14I800R	1702.69

Female I-line Solid End Caps - 16AI-15I



Tube OD	Dimensions		304 Stainless Steel		316L Stainless Steel	
	A	B	Part #	Price/E	Part #	Price/E
1"	.500"	1.985"	16AI-15I100	\$16.89	16AI-15I100R	\$23.68
1½"	.500"	1.985"	16AI-15I150	16.89	16AI-15I150R	52.02
2"	.562"	2.640"	16AI-15I200	25.84	16AI-15I200R	84.87
2½"	.750"	3.307"	16AI-15I250	43.27	16AI-15I250R	191.62
3"	.750"	3.870"	16AI-15I300	56.26	16AI-15I300R	189.41
4"	.750"	4.870"	16AI-15I400	96.33	16AI-15I400R	140.23
6"	.750"	7.495"	---	---	16AI-15I600R	336.46
8"	.880"	9.495"	---	---	16AI-15I800R	551.38

Q-Line Solid End Caps - 16AQ

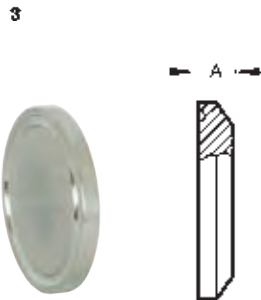

Tube OD	Dimension A	304 Stainless Steel	
	A	Part #	Price/E
1"	.313"	16AQ-G100	\$68.38
1½"	.313"	16AQ-G150	44.55
2"	.438"	16AQ-G200	64.10
2½"	.500"	16AQ-G250	176.92
3"	.500"	16AQ-G300	230.77
4"	.625"	16AQ-G400	292.30

I-Line Gaskets

Buna-N I-Line Gaskets - Black

Features:

- color code: red dot
- meets 21CFR 177.2600
- 3/32" thickness

Size	Buna-N	
	Part #	Price/E
1"	40IH100	\$1.74
1½"	40IH150	1.54
2"	40IH200	1.41
2½"	40IH250	2.62
3"	40IH300	3.28
4"	40IH400	4.23
6"	40IH600	19.42
8"	40IH800	38.14



PTFE I-Line Gaskets - White

Features:

- color code: no dot
- meets 21CFR 177.1550
- passed USP class VI cytotoxicity testing
- 1/16" thickness

Size	PTFE	
	Part #	Price/E
1"	40IT100	\$2.03
1½"	40IT150	3.26
2"	40IT200	3.08
2½"	40IT250	3.95
3"	40IT300	4.13
4"	40IT400	5.96
6"	40IT600	107.47
8"	40IT800	157.80



PTFE is a material subject to plastic flow. When cycled through heat and then cooled down in process lines, PTFE gaskets will not return to the original configuration and it will continue to compress as the cycling continues. This plastic flow will allow leakage if clamp torques are not maintained. 

EPDM I-Line Gaskets - White

Features:

- color code: three green dots
- meets 21CFR 177.2600
- passed USP class VI cytotoxicity testing
- peroxide cured
- 3/32" thickness

Size	EPDM	
	Part #	Price/E
1"	40IE100	\$3.02
1½"	40IE150	2.82
2"	40IE200	3.28
2½"	40IE250	4.23
3"	40IE300	6.37
4"	40IE400	8.91
6"	40IE600	POR
8"	40IE800	76.42



I-Line Gaskets

FKM I-Line Gaskets - Black

Features:

- color code: one white dot, one yellow dot
- meets 21CFR 177.1550
- passed USP Class VI Cytotoxicity testing
- peroxide cured
- 1/16" thickness



Size	FKM	
	Part #	Price/E
1"	40IV100	\$10.63
1½"	40IV150	8.52
2"	40IV200	10.13
2½"	40IV250	12.08
3"	40IV300	14.62
4"	40IV400	20.51
6"	40IV600	112.37
8"	40IV800	92.51

Q-line Gaskets

Buna-N Q-Line Gaskets - Black

Features:

- color code: red dot
- meets 21CFR 177.2600



Size	Buna-N	
	Part #	Price/E
1"	40QH100	\$3.46
1½"	40QH150	3.46
2"	40QH200	4.55
2½"	40QH250	5.64
3"	40QH300	7.88
4"	40QH400	11.47

PTFE Q-Line Gaskets - White

Features:

- color code: no dot
- meets 21CFR 177.1550
- passed USP Class VI Cytotoxicity testing



Size	PTFE	
	Part #	Price/E
1"	40QT100	\$10.45
1½"	40QT150	22.41
2"	40QT200	31.37
2½"	40QT250	36.19
3"	40QT300	22.56
4"	40QT400	34.69

PTFE is a material subject to plastic flow. When cycled through heat and then cooled down in process lines, PTFE gaskets will not return to the original configuration and it will continue to compress as the cycling continues. This plastic flow will allow leakage if clamp torques are not maintained.



Pipe Size Clamps

Schedule 5S and 10S Single Pin Heavy Duty Clamps - 13MHHV

Pipe Size	Service Pressure PSI Rating @ 70°F (21°C) ¹	Dimension A	304 Stainless Steel	
			Part #	Price/E
1"	500	2.122"	13MHHV100	\$13.93
1½"	450	2.654"	13MHHV150	16.89
2"	400	3.185"	13MHHV200	19.66
2½"	350	3.717"	13MHHV250	21.81
3"	250	4.263"	13MHHV300	43.94
4"	150	5.263"	13MHHV400	65.95
6"	100	7.500"	13MHHV600	219.98

¹ wing nut tightened to 25 in. lbs. of torque

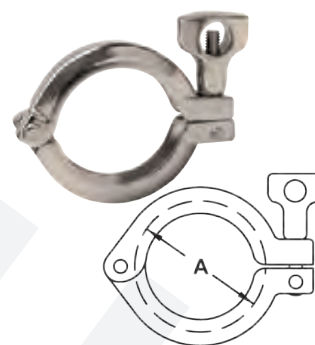

Pipe, Welding
& Tube Fittings

Bolted Clamp - 13MHPV400

Pipe Size	Service Pressure PSI Rating @ 70°F (21°C) ¹	Dimension A	304 Stainless Steel	
			Part #	Price/E
4"	400	5.187"	13MHPV400	\$100.32

¹ nut tightened to 20 ft. lbs. of torque

- For additional information on pipe dimensions please reference dixonvalve.com.

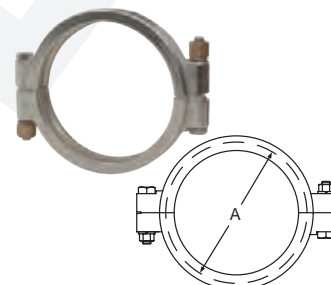

Pipe Size Ferrules

Schedule 5S Short Weld Ferrules - 14WMV

Pipe Size	Dimensions			316L Stainless Steel	
	A	B	C	Part #	Price/E
1"	.500"	1.185"	1.315"	14WMV-R100	\$26.20
1½"	.500"	1.770"	1.900"	14WMV-R150	35.54
2"	.500"	2.245"	2.375"	14WMV-R200	52.38
2½"	.500"	2.709"	2.875"	14WMV-R250	67.62
3"	.500"	3.334"	3.500"	14WMV-R300	101.88
4"	.625"	4.334"	4.500"	14WMV-R400	181.64
6"	.875"	6.407"	6.625"	14WMV-R600	217.64

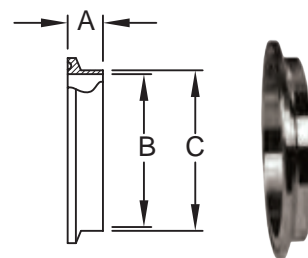

3

Schedule 10S Short Weld Ferrules - 14WMX

Pipe Size	Dimensions			316L Stainless Steel	
	A	B	C	Part #	Price/E
1"	.500"	1.097"	1.315"	14WMX-R100	\$26.20
1½"	.500"	1.682"	1.900"	14WMX-R150	35.54
2"	.500"	2.157"	2.375"	14WMX-R200	52.38
2½"	.500"	2.635"	2.875"	14WMX-R250	67.62
3"	.500"	3.260"	3.500"	14WMX-R300	101.88
4"	.625"	4.260"	4.500"	14WMX-R400	181.64

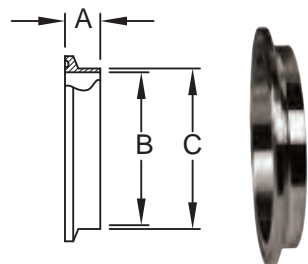

3

- For additional information on pipe dimensions please reference dixonvalve.com.

Pipe Size Ferrules

Pipe, Welding & Tube Fittings

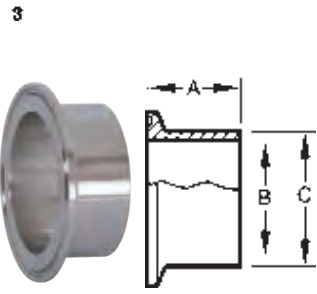

Schedule 5S Long Weld Ferrules - L14AM7V

Pipe Size	Dimensions			316L Stainless Steel	
	A	B	C	Part #	Price/E
1"	1.125"	1.185"	1.315"	L14AM7V-R100	\$51.37
1½"	1.125"	1.770"	1.900"	L14AM7V-R150	72.37
2"	1.125"	2.245"	2.375"	L14AM7V-R200	108.07
2½"	1.125"	2.709"	2.875"	L14AM7V-R250	126.33
3"	1.125"	3.334"	3.500"	L14AM7V-R300	195.78
4"	1.125"	4.334"	4.500"	L14AM7V-R400	283.96

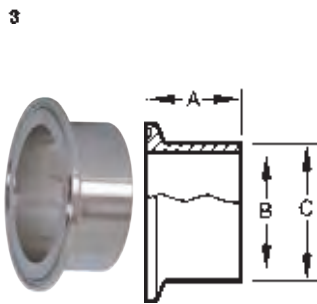

Schedule 10S Long Weld Ferrules - L14AM7X

Pipe Size	Dimensions			316L Stainless Steel	
	A	B	C	Part #	Price/E
1"	1.125"	1.097"	1.315"	L14AM7X-R100	\$51.37
1½"	1.125"	1.682"	1.900"	L14AM7X-R150	72.37
2"	1.125"	2.157"	2.375"	L14AM7X-R200	108.07
2½"	1.125"	2.635"	2.875"	L14AM7X-R250	126.33
3"	1.125"	3.260"	3.500"	L14AM7X-R300	195.78
4"	1.125"	4.260"	4.500"	L14AM7X-R400	283.96

- For additional information on pipe dimensions please reference dixonvalve.com.

Pipe Size End Caps

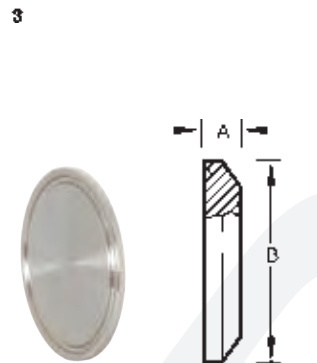

Schedule 5S and 10S Solid End Caps - 16AMV

Pipe Size	Dimensions		304 Stainless Steel		316L Stainless Steel	
	A	B	Part #	Price/E	Part #	Price/E
1"	.250"	1.984"	16AMV-G100	\$6.73	16AMV-R100	\$8.34
1½"	.250"	2.516"	16AMV-G150	8.55	16AMV-R150	12.11
2"	.250"	3.047"	16AMV-G200	13.06	16AMV-R200	18.30
2½"	.250"	3.579"	16AMV-G250	17.63	16AMV-R250	24.23
3"	.312"	4.125"	16AMV-G300	240.31	16AMV-R300	112.43
4"	.312"	5.125"	16AMV-G400	307.69	16AMV-R400	172.68

- Specify if you are using a piping system or a tubing system when ordering.
- For additional information on pipe dimensions please reference dixonvalve.com.

Pipe Size Adapters

Tube OD Weld x Schedule 5S Weld Adapters - B19WV

Pipe Size	Dimension A	Tube Wall Thickness	Pipe Wall Thickness	316L Stainless Steel	
				Part #	Price/E
1"	2.000"	.065"	.065"	B19WV-R100	\$33.28
1½"	2.500"	.065"	.065"	B19WV-R150	63.32
2"	2.500"	.065"	.065"	B19WV-R200	113.88
2½"	2.500"	.065"	.084"	B19WV-R250	119.80
3"	2.500"	.065"	.084"	B19WV-R300	210.00
4"	3.000"	.084"	.084"	B19WV-R400	258.47

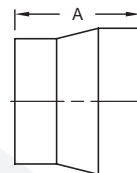

Pipe, Welding & Tube Fittings

Tube OD Weld x Schedule 10S Weld Adapters - B19WX

Pipe Size	Dimension A	Tube Wall Thickness	Pipe Wall Thickness	316L Stainless Steel	
				Part #	Price/E
1"	2.000"	.065"	.109"	B19WX-R100	\$79.48
1½"	2.500"	.065"	.109"	B19WX-R150	98.95
2"	2.500"	.065"	.109"	B19WX-R200	118.72
2½"	2.500"	.065"	.120"	B19WX-R250	132.47
3"	2.500"	.065"	.120"	B19WX-R300	164.42
4"	3.000"	.084"	.120"	B19WX-R400	280.90



Clamp x Schedule 10S Weld Adapters - B19MPX

Pipe Size	Dimensions			Pipe Wall Thickness	316L Stainless Steel	
	A	B	C		Part #	Price/E
1"	1.125"	1.097"	1.315"	.109"	B19MPX-R100	\$57.46
1½"	1.125"	1.682"	1.900"	.109"	B19MPX-R150	114.46
2"	1.125"	2.157"	2.375"	.109"	B19MPX-R200	172.38
2½"	1.125"	2.635"	2.875"	.120"	B19MPX-R250	189.23
3"	1.125"	3.260"	3.500"	.120"	B19MPX-R300	235.38
4"	1.125"	4.260"	4.500"	.120"	B19MPX-R400	282.70

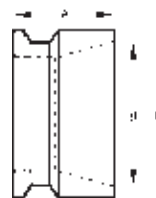

- For additional information on pipe dimensions please reference dixonvalve.com.



Pipe Size Hangers

Pipe, Welding & Tube Fittings

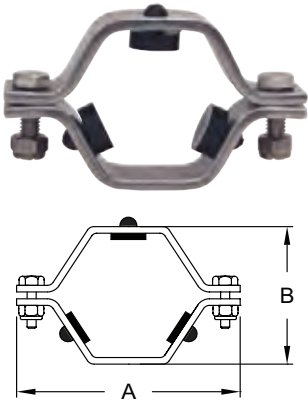

Pipe Size Hex Hanger with Rubber Grommets - B24RV¹

Pipe Size	Dimensions		304 Stainless Steel	
	A	B	Part #	Price/E
1"	3.625"	2.125"	B24RV-G100	\$24.68
1½"	3.625"	2.125"	B24RV-G150	26.85
2"	4.312"	2.625"	B24RV-G200	29.67
2½"	4.875"	3.125"	B24RV-G250	33.65
3"	5.375"	3.625"	B24RV-G300	39.55
4"	7.500"	4.750"	B24RV-G400	40.19
6"	9.000"	6.625"	B24RV-G600	113.91

¹ for coupler options call Dixon®

Pipe Size Hex Hanger with Polypropylene Sleeves - B24PV¹

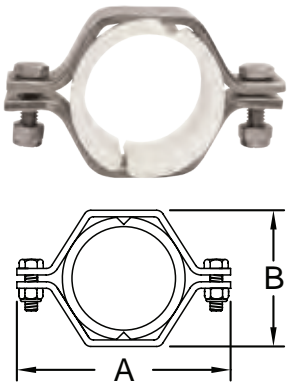

Pipe Size	Dimensions		304 Stainless Steel	
	A	B	Part #	Price/E
1"	3.750"	3.000"	B24PV-G100	\$39.42
1½"	4.312"	2.625"	B24PV-G150	40.06
2"	5.000"	3.125"	B24PV-G200	44.29
2½"	5.625"	3.500"	B24PV-G250	54.74
3"	6.000"	4.250"	B24PV-G300	54.94
4"	7.500"	2.000"	B24PV-G400	62.69
6"	9.750"	7.125"	B24PV-G600	221.67

¹ for coupler options call Dixon®

Pipe Size Sleeves - 13PV



Size	Polypropylene	
	Part #	Price/E
1"	13PV-100	\$19.02
1½"	13PV-150	19.02
2"	13PV-200	19.73
2½"	13PV-250	28.89
3"	13PV-300	20.14
4"	13PV-400	29.66
6"	13PV-600	127.90

• For additional information on pipe dimensions please reference dixonvalve.com.

Schedule 5S and 10S Pipe Gaskets

Buna-N Pipe Gaskets- 40MPV-U, Black

Features:

- color code: red dot
- meets 21CFR 177.2600

Size	Buna-N	
	Part #	Price/E
1"	40MPV-U100	\$10.66
1½"	40MPV-U150	7.11
2"	40MPV-U200	7.50
2½"	40MPV-U250	9.23
3"	40MPV-U300	7.88
4"	40MPV-U400	6.57



PTFE Pipe Gaskets - 40MPV-G, White

Features:

- color code: no dot
- meets 21CFR 177.1550
- passed USP Class VI Cytotoxicity testing
- not recommended for use with bolted clamps



Size	PTFE	
	Part #	Price/E
1"	40MPV-G100	\$33.21
1½"	40MPV-G150	25.46
2"	40MPV-G200	39.93
2½"	40MPV-G250	49.40
3"	40MPV-G300	68.37
4"	40MPV-G400	65.46



PTFE is a material subject to plastic flow. When cycled through heat and then cooled down in process lines, PTFE gaskets will not return to the original configuration and it will continue to compress as the cycling continues. This plastic flow will allow leakage if clamp torques are not maintained.



Weld Elbows

Pipe, Welding & Tube Fittings

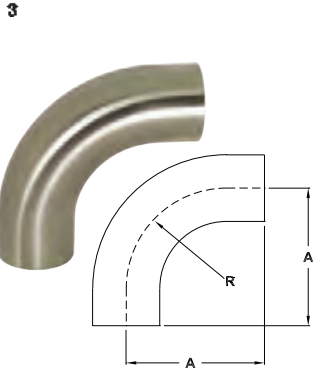

Polished 90° Weld Elbows with Tangents - B2S

Tube OD	Dimensions		Wall Thickness	polished ID/OD 304 Stainless Steel		polished ID/OD 316L Stainless Steel	
	A	R		Part #	Price/E	Part #	Price/E
1/2"	3.000"	1.125"	.065"	---	---	B2S-R50P	\$52.02
3/4"	3.000"	1.125"	.065"	---	---	B2S-R75P	49.20
1"	2.062"	1.500"	.065"	B2S-G100P	\$26.79	B2S-R100P	30.28
1 1/2"	2.937"	2.250"	.065"	B2S-G150P	28.54	B2S-R150P	34.62
2"	4.062"	3.000"	.065"	B2S-G200P	34.65	B2S-R200P	45.96
2 1/2"	5.187"	3.750"	.065"	B2S-G250P	49.60	B2S-R250P	69.68
3"	6.312"	4.500"	.065"	B2S-G300P	69.63	B2S-R300P	101.55
4"	8.312"	6.000"	.083"	B2S-G400P	139.30	B2S-R400P	174.63

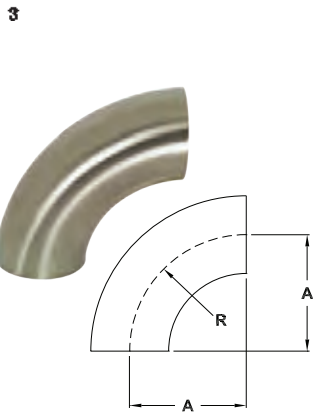

Polished 90° Weld Elbows - B2WCL

Tube OD	Dimensions		Wall Thickness	polished ID/OD 304 Stainless Steel		polished ID/OD 316L Stainless Steel	
	A	R		Part #	Price/E	Part #	Price/E
1/2"	1.125"	1.125"	.065"	---	---	B2WCL-R50P	\$31.15
3/4"	1.125"	1.125"	.065"	---	---	B2WCL-R75P	32.21
1"	1.500"	1.500"	.065"	B2WCL-G100P	\$15.29	B2WCL-R100P	19.22
1 1/2"	2.250"	2.250"	.065"	B2WCL-G150P	19.92	B2WCL-R150P	25.64
2"	3.000"	3.000"	.065"	B2WCL-G200P	27.72	B2WCL-R200P	33.42
2 1/2"	3.750"	3.750"	.065"	B2WCL-G250P	40.76	B2WCL-R250P	60.13
3"	4.500"	4.500"	.065"	B2WCL-G300P	49.30	B2WCL-R300P	74.29
4"	6.000"	6.000"	.083"	B2WCL-G400P	110.07	B2WCL-R400P	137.79
6"	9.000"	9.000"	.109"	B2WCL-G600P	407.88	B2WCL-R600P	480.00
8"	12.000"	12.000"	.120"	B2WCL-G800P	795.39	B2WCL-R800P	1035.90

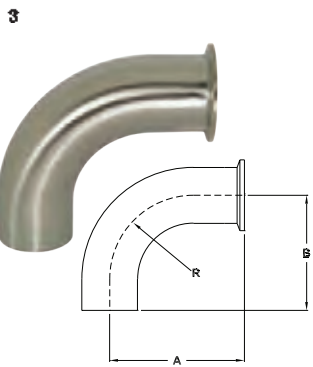

Polished 90° Clamp x Weld Elbows - B2CM

Tube OD	Dimensions			Wall Thickness	polished ID/OD 304 Stainless Steel		polished ID/OD 316L Stainless Steel	
	A	B	R		Part #	Price/E	Part #	Price/E
1"	2.562"	2.062"	1.500"	.065"	B2CM-G100	\$55.90	B2CM-R100	\$84.81
1 1/2"	3.438"	2.937"	2.250"	.065"	B2CM-G150	60.13	B2CM-R150	78.04
2"	4.562"	4.062"	3.000"	.065"	B2CM-G200	76.11	B2CM-R200	110.66
2 1/2"	5.688"	5.187"	3.750"	.065"	B2CM-G250	117.18	B2CM-R250	103.08
3"	6.812"	6.312"	4.500"	.065"	B2CM-G300	144.95	B2CM-R300	216.65
4"	8.937"	8.312"	6.000"	.083"	B2CM-G400	265.00	B2CM-R400	326.15

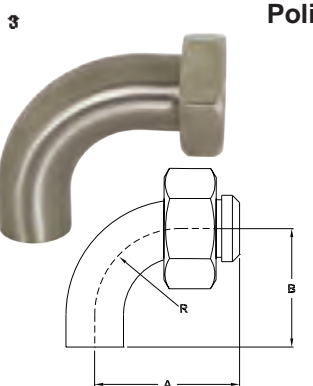

Polished 90° Plain Bevel Seat with Hex Nut x Weld Elbows - B2FP

Tube OD	Dimensions			Wall Thickness	polished ID/OD 304 Stainless Steel	
	A	B	R		Part #	Price/E
1 1/2"	3.656"	2.937"	2.250"	.065"	B2FP-G150	\$135.99
2"	4.812"	4.062"	3.000"	.065"	B2FP-G200	161.55
2 1/2"	6.062"	5.187"	3.750"	.065"	B2FP-G250	221.73
3"	7.218"	6.312"	4.500"	.065"	B2FP-G300	268.94

Weld Elbows

Polished 45° Weld Elbows with Tangents - B2KS

Tube OD	Dimensions		Wall Thickness	polished ID/OD 304 Stainless Steel		polished ID/OD 316L Stainless Steel	
	A	R		Part #	Price/E	Part #	Price/E
¾"	2.250"	2.250"	.065"	---	---	B2KS-R75P	\$46.99
1"	1.188"	1.188"	.065"	B2KS-G100P	\$24.46	B2KS-R100P	24.46
1½"	1.625"	1.625"	.065"	B2KS-G150P	25.28	B2KS-R150P	29.36
2"	2.312"	2.312"	.065"	B2KS-G200P	31.59	B2KS-R200P	38.05
2½"	3.000"	3.000"	.065"	B2KS-G250P	44.17	B2KS-R250P	59.30
3"	3.688"	3.688"	.065"	B2KS-G300P	61.84	B2KS-R300P	81.55
4"	4.812"	4.812"	.083"	B2KS-G400P	101.83	B2KS-R400P	139.30

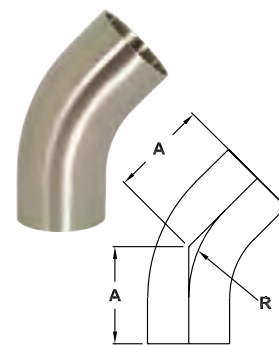

Pipe, Welding & Tube Fittings

Polished 45° Weld Elbows - B2WK

Tube OD	Dimensions		Wall Thickness	polished ID/OD 304 Stainless Steel		polished ID/OD 316L Stainless Steel	
	A	R		Part #	Price/E	Part #	Price/E
1"	.625"	1.500"	.065"	B2WK-G100P	\$14.57	B2WK-R100P	\$22.02
1½"	.937"	2.250"	.065"	B2WK-G150P	17.84	B2WK-R150P	20.38
2"	1.250"	3.000"	.065"	B2WK-G200P	23.56	B2WK-R200P	36.11
2½"	1.562"	3.750"	.065"	B2WK-G250P	35.33	B2WK-R250P	49.94
3"	1.875"	4.500"	.065"	B2WK-G300P	60.57	B2WK-R300P	72.22
4"	2.500"	6.000"	.083"	B2WK-G400P	101.93	B2WK-R400P	143.27
6"	3.750"	9.000"	.109"	B2WK-G600P	322.50	B2WK-R600P	444.61
8"	5.000"	12.000"	.120"	---	---	B2WK-R800P	706.73

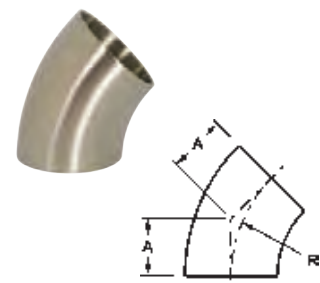

Polished 45° Clamp x Weld Elbows - B2KM

Tube OD	Dimensions			Wall Thickness	polished ID/OD 304 Stainless Steel		polished ID/OD 316L Stainless Steel	
	A	B	R		Part #	Price/E	Part #	Price/E
1"	1.188"	1.688"	1.500"	.065"	B2KM-G100	\$94.92	B2KM-R100	\$88.72
1½"	1.625"	2.125"	2.250"	.065"	B2KM-G150	95.49	B2KM-R150	93.77
2"	2.312"	2.812"	3.000"	.065"	B2KM-G200	106.91	B2KM-R200	107.91
2½"	3.000"	3.500"	3.750"	.065"	B2KM-G250	152.31	B2KM-R250	131.26
3"	3.688"	4.188"	4.500"	.065"	B2KM-G300	171.37	B2KM-R300	172.78
4"	4.812"	5.437"	6.000"	.083"	B2KM-G400	260.09	B2KM-R400	263.04

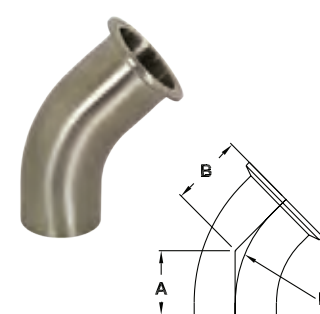

Weld Sweep Elbows

Feature:

- tangents, 45° and other radii elbows are available, call Dixon® for information

Polished 12" 90° Weld Sweep Elbows - B2SXL

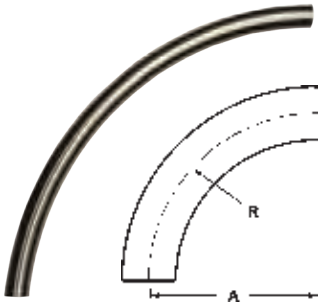

Tube OD	Dimensions		316L Stainless Steel	
	A	R	Part #	Price/E
1½"	12.00"	12.00"	B2SXL12-R150	\$910.77
2"	12.00"	12.00"	B2SXL12-R200	969.23
3"	12.00"	12.00"	B2SXL12-R300	1137.42
4"	12.00"	12.00"	B2SXL12-R400	1446.16

Polished 18" 90° Weld Sweep Elbows - B2SXL

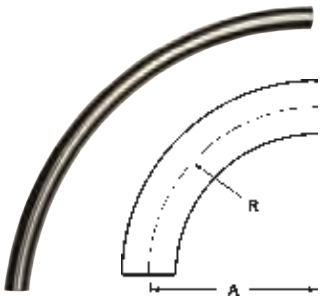

Tube OD	Dimensions		316L Stainless Steel	
	A	R	Part #	Price/E
1½"	18.00"	18.00"	B2SXL18-R150	\$1169.23
2"	18.00"	18.00"	B2SXL18-R200	1169.24
2½"	18.00"	18.00"	B2SXL18-R250	1193.85
3"	18.00"	18.00"	B2SXL18-R300	1516.56

Polished 24" 90° Weld Sweep Elbows - B2SXL

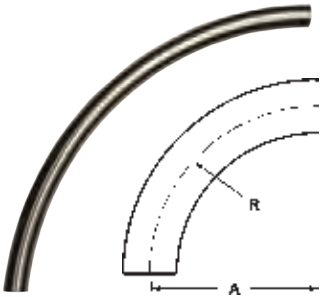

Tube OD	Dimensions		316L Stainless Steel	
	A	R	Part #	Price/E
1½"	24.00"	24.00"	B2SXL24-R150	\$1296.41
2"	24.00"	24.00"	B2SXL24-R200	1193.85
2½"	24.00"	24.00"	B2SXL24-R250	1292.30
3"	24.00"	24.00"	B2SXL24-R300	1681.39

Polished 36" 90° Weld Sweep Elbows - B2SXL

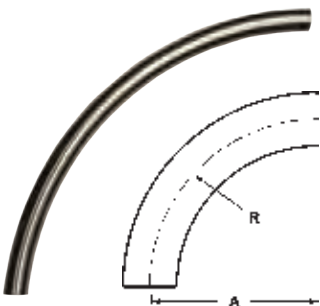

Tube OD	Dimensions		316L Stainless Steel	
	A	R	Part #	Price/E
3"	36.00"	36.00"	B2SXL36-R300	\$2785.80
4"	36.00"	36.00"	B2SXL36-R400	3307.69

Weld Tees

Polished Short Weld Tees - B7WWW

Tube OD	Dimensions		Wall Thickness	polished ID/OD 304 Stainless Steel		polished ID/OD 316L Stainless Steel	
	A	B		Part #	Price/E	Part #	Price/E
1"	2.250"	1.125"	.065"	B7WWW-G100P	\$27.95	B7WWW-R100P	\$42.40
1½"	3.312"	1.656"	.065"	B7WWW-G150P	37.28	B7WWW-R150P	41.93
2"	4.124"	2.062"	.065"	B7WWW-G200P	44.84	B7WWW-R200P	50.96
2½"	4.688"	2.344"	.065"	B7WWW-G250P	56.05	B7WWW-R250P	68.29
3"	5.188"	2.594"	.065"	B7WWW-G300P	78.48	B7WWW-R300P	102.50
4"	6.876"	3.438"	.083"	B7WWW-G400P	122.31	B7WWW-R400P	146.15

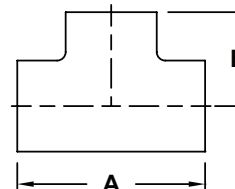

Pipe, Welding & Tube Fittings

Polished Long Weld Tees - B7W

Tube OD	Dimensions		Wall Thickness	polished ID/OD 304 Stainless Steel		polished ID/OD 316L Stainless Steel	
	A	B		Part #	Price/E	Part #	Price/E
¾"	4.000"	2.000"	.065"	---	---	B7W-R75P	\$73.22
1"	3.750"	1.875"	.065"	B7W-G100P	\$32.03	B7W-R100P	36.11
1½"	4.500"	2.250"	.065"	B7W-G150P	37.09	B7W-R150P	48.92
2"	6.000"	3.000"	.065"	B7W-G200P	44.03	B7W-R200P	66.24
2½"	6.000"	3.000"	.065"	B7W-G250P	44.16	B7W-R250P	53.73
3"	6.500"	3.250"	.065"	B7W-G300P	81.55	B7W-R300P	111.10
4"	7.750"	3.875"	.083"	B7W-G400P	152.88	B7W-R400P	209.67

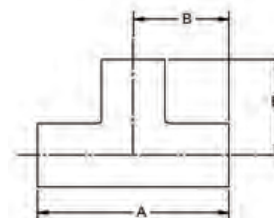

Polished Reducing Weld Tees - B7RWWW

Tube OD	Dimensions				Wall Thick.	polished ID/OD 304 Stainless Steel		polished ID/OD 316L Stainless Steel	
	A	B	C	D		Part #	Price/E	Part #	Price/E
1½" x 1"	3.312"	1.375"	1.500"	1.000"	.065"	B7RWWW-G150100P	\$57.08	B7RWWW-R150100P	\$65.23
2" x 1"	4.124"	1.625"	2.000"	1.000"	.065"	B7RWWW-G200100P	78.47	B7RWWW-R200100P	88.07
2" x 1½"	4.124"	1.906"	2.000"	1.500"	.065"	B7RWWW-G200150P	78.47	B7RWWW-R200150P	88.07
2½" x 1½"	4.688"	2.156"	2.500"	1.500"	.065"	B7RWWW-G250150P	69.90	B7RWWW-R250150P	82.71
2½" x 2"	4.688"	2.312"	2.500"	2.000"	.065"	B7RWWW-G250200P	71.06	B7RWWW-R250200P	82.71
3" x 1½"	5.188"	2.406"	3.000"	1.500"	.065"	B7RWWW-G300150P	97.85	B7RWWW-R300150P	111.83
3" x 2"	5.188"	2.562"	3.000"	2.000"	.065"	B7RWWW-G300200P	97.85	B7RWWW-R300200P	111.83
4" x 2"	6.876"	3.062"	4.000"	2.000"	.083"	B7RWWW-G400200P	170.07	B7RWWW-R400200P	201.51
4" x 3"	6.876"	3.094"	4.000"	3.000"	.083"	B7RWWW-G400300P	171.24	B7RWWW-R400300P	203.84

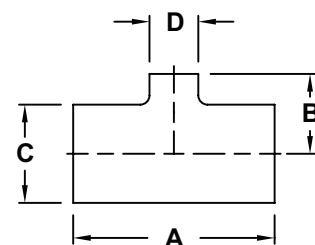

Weld Adapters

Long Weld Hose Adapters - 14WHRL

Pipe, Welding & Tube Fittings

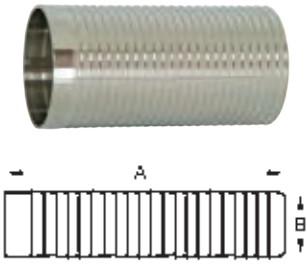

Feature:

- suitable for use with band clamps

Tube OD	Dimensions		Wall Thickness	316L Stainless Steel	
	A	B		Part #	Price/E
1"	3.000"	1.030"	.116"	14WHRL-R100	\$36.01
1½"	4.500"	1.030"	.116"	14WHRL-R150	63.03
2"	4.500"	2.030"	.116"	14WHRL-R200	80.43
2½"	5.000"	2.530"	.116"	14WHRL-R250	107.58
3"	5.000"	3.030"	.116"	14WHRL-R300	116.41
4"	4.875"	4.030"	.116"	14WHRL-R400	163.55

Use of PVC tubing requires special installation techniques to prevent leakage. All assembly work must be done with heated tube. Cold durometer is 90 as opposed to rubber hose at 65 to 70 durometer. Banding buckles must be at 180° from one another.

Weld Reducers

Polished Concentric Weld Reducers - B31W

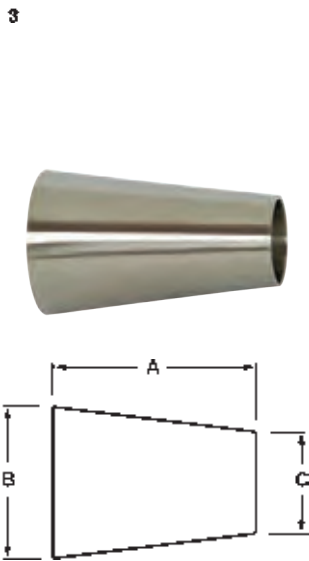

Tube OD	Dimensions			Wall Thickness	polished ID/OD 304 Stainless Steel		polished ID/OD 316L Stainless Steel	
	A	B	C		Part #	Price/E	Part #	Price/E
¾" x ½"	1.000"	.750"	.500"	.065"	---	---	B31W-R7550P	\$57.08
1" x ½"	2.000"	1.000"	.500"	.065"	---	---	B31W-R10050P	108.97
1" x ¾"	1.000"	1.000"	.750"	.065"	---	---	B31W-R10075P	57.08
1½" x ¾"	3.000"	1.500"	.750"	.065"	---	---	B31W-R15075P	81.55
1½" x 1"	2.000"	1.500"	1.000"	.065"	B31W-G150100P	\$33.79	B31W-R150100P	37.28
2" x 1"	4.000"	2.000"	1.000"	.065"	B31W-G200100P	67.31	B31W-R200100P	79.20
2" x 1½"	2.000"	2.000"	1.500"	.065"	B31W-G200150P	37.28	B31W-R200150P	49.45
2½" x 1½"	4.000"	2.500"	1.500"	.065"	B31W-G250150P	63.42	B31W-R250150P	85.04
2½" x 2"	2.000"	2.500"	2.000"	.065"	B31W-G250200P	40.76	B31W-R250200P	31.11
3" x 1½"	6.000"	3.000"	1.500"	.065"	B31W-G300150P	114.15	B31W-R300150P	154.92
3" x 2"	4.000"	3.000"	2.000"	.065"	B31W-G300200P	60.05	B31W-R300200P	76.93
3" x 2½"	2.000"	3.000"	2.500"	.065"	B31W-G300250P	58.25	B31W-R300250P	84.81
4" x 2"	8.000"	4.000"	2.000"	.083"	B31W-G400200P	152.88	B31W-R400200P	186.38
4" x 2½"	6.000"	4.000"	2.500"	.083"	B31W-G400250P	145.61	B31W-R400250P	174.73
4" x 3"	4.000"	4.000"	3.000"	.083"	B31W-G400300P	88.67	B31W-R400300P	110.66
6" x 3"	5.500"	6.000"	3.000"	.109"	B31W-G600300P	289.91	B31W-R600300P	392.41
6" x 4"	5.500"	6.000"	4.000"	.109"	B31W-G600400P	323.07	B31W-R600400P	336.65

Polished Eccentric Weld Reducers - B32W

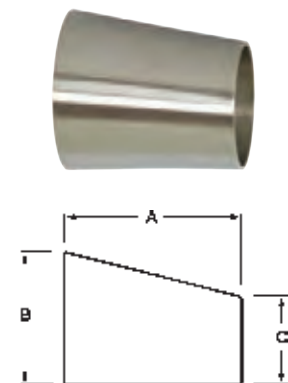

Tube OD	Dimensions			Wall Thickness	polished ID/OD 304 Stainless Steel		polished ID/OD 316L Stainless Steel	
	A	B	C		Part #	Price/E	Part #	Price/E
1" x ½"	2.000"	1.000"	.500"	.065"	---	---	B32W-R10050P	\$114.15
2" x 1"	4.000"	2.000"	1.000"	.065"	B32W-G200100P	\$122.31	B32W-R200100P	133.73
2" x 1½"	2.000"	2.000"	1.500"	.065"	B32W-G200150P	51.25	B32W-R200150P	57.08
2½" x 2"	2.000"	2.500"	2.000"	.065"	B32W-G250200P	60.57	B32W-R250200P	40.85
3" x 2"	4.000"	3.000"	2.000"	.065"	B32W-G300200P	97.85	B32W-R300200P	101.93
3" x 2½"	2.000"	3.000"	2.500"	.065"	B32W-G300250P	81.55	B32W-R300250P	117.41
4" x 2"	8.000"	4.000"	2.000"	.083"	B32W-G400200P	215.49	B32W-R400200P	232.97
4" x 3"	4.000"	4.000"	3.000"	.083"	B32W-G400300P	125.00	B32W-R400300P	128.13

Weld Crosses

Polished Weld Crosses - B9WWWW

Tube OD	Dimensions		Wall Thickness	polished ID/OD 304 Stainless Steel		polished ID/OD 316L Stainless Steel	
	A	B		Part #	Price/E	Part #	Price/E
1½"	3.312"	1.656"	.065"	B9WWWW-G150P	\$136.24	B9WWWW-R150P	\$105.99
2"	4.125"	2.062"	.065"	B9WWWW-G200P	122.31	B9WWWW-R200P	138.61
3"	5.187"	2.593"	.065"	B9WWWW-G300P	192.19	B9WWWW-R300P	285.39
4"	6.875"	3.437"	.083"	B9WWWW-G400P	414.69	B9WWWW-R400P	497.39

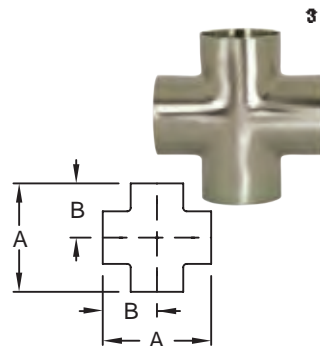

Pipe, Welding & Tube Fittings

Miscellaneous Weld Configurations

Polished Weld Laterals - B28WA

Tube OD	Dimensions			Wall Thickness	polished ID/OD 316L Stainless Steel	
	A	B	R		Part #	Price/E
1"	6.000"	1.000"	5.000"	.065"	B28WA-R100P	\$326.15
1½"	7.375"	1.188"	6.188"	.065"	B28WA-R150P	375.08
2"	8.750"	1.625"	7.125"	.065"	B28WA-R200P	538.15
2½"	10.000"	1.500"	8.500"	.065"	B28WA-R250P	684.93
3"	10.750"	1.875"	8.875"	.065"	B28WA-R300P	629.01
4"	12.812"	2.015"	10.750"	.083"	B28WA-R400P	955.16

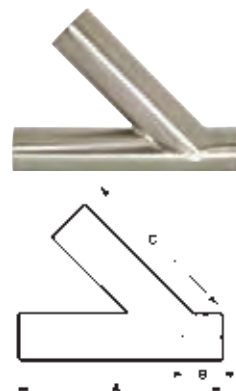

Polished Weld True Wyes - B28W

Tube OD	Dimensions		Wall Thickness	polished ID/OD 316L Stainless Steel	
	A	B		Part #	Price/E
1"	2.000"	2.438"	.065"	B28W-R100P	\$342.45
1½"	2.000"	2.438"	.065"	B28W-R150P	391.38
2"	2.625"	3.250"	.065"	B28W-R200P	407.70
2½"	3.370"	4.125"	.065"	B28W-R250P	512.53
3"	4.000"	4.875"	.065"	B28W-R300P	652.30
4"	5.375"	5.375"	.083"	B28W-R400P	1001.76

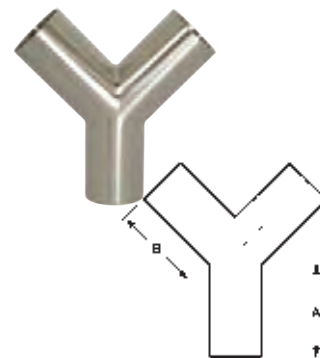

Polished Weld 180° Return Bends - B2WUL

Feature:

- bends are standard 1.5 x tube diameter

Tube OD	Dimensions		polished ID/OD 316L Stainless Steel	
	A	B	Part #	Price/E
1"	3.000"	2.000"	B2WUL-R100P	\$153.46
1½"	4.500"	3.000"	B2WUL-R150P	177.69
2"	6.000"	4.000"	B2WUL-R200P	292.30
2½"	7.500"	5.000"	B2WUL-R250P	339.23
3"	9.000"	6.000"	B2WUL-R300P	492.69
4"	12.000"	8.000"	B2WUL-R400P	686.53

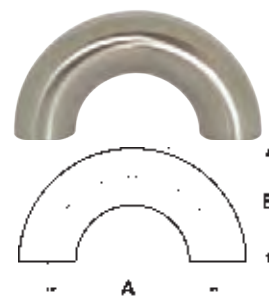

Weld End Blue Protection Covers - BCW

Feature:

- Use these covers to protect all weld ends on fittings and valves.



Size	Vinyl Plastic	
	Part #	Price/E
1/2"	BCW-050	\$0.41
3/4"	BCW-075	0.70
1"	BCW-100	0.95
1 1/2"	BCW-150	1.18
2"	BCW-200	1.43
2 1/2"	BCW-250	2.13
3"	BCW-300	2.49
4"	BCW-400	3.92
6"	BCW-600	12.96
8"	BCW-800	23.27

Unpolished Elbows

Unpolished 90° Weld Elbows with Tangents - B2S

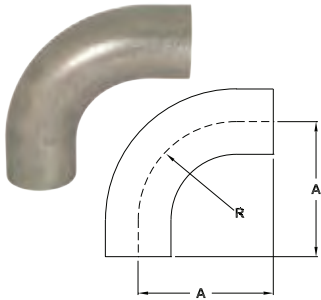

Tube OD	Dimensions		Wall Thickness	unpolished 304 Stainless Steel		unpolished 316L Stainless Steel	
	A	R		Part #	Price/E	Part #	Price/E
3/4"	3.000"	1.125"	.065"	---	---	B2S-R75U	\$40.96
1"	2.062"	1.500"	.065"	B2S-G100U	\$11.86	B2S-R100U	13.58
1 1/2"	2.937"	2.250"	.065"	B2S-G150U	19.02	B2S-R150U	23.40
2"	4.062"	3.000"	.065"	B2S-G200U	29.21	B2S-R200U	37.37
2 1/2"	5.187"	3.750"	.065"	B2S-G250U	41.45	B2S-R250U	55.71
3"	6.312"	4.500"	.065"	B2S-G300U	64.56	B2S-R300U	81.60
4"	8.312"	6.000"	.083"	B2S-G400U	118.90	B2S-R400U	108.03

Unpolished 90° Weld Elbows - B2WCL

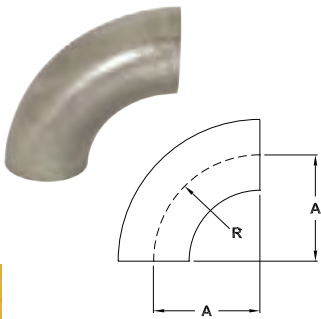

Tube OD	Dimensions		Wall Thickness	unpolished 304 Stainless Steel		unpolished 316L Stainless Steel	
	A	R		Part #	Price/E	Part #	Price/E
1/2"	1.125"	1.125"	.065"	---	---	B2WCL-R50U	\$16.60
3/4"	1.125"	1.125"	.065"	---	---	B2WCL-R75U	16.93
1"	1.500"	1.500"	.065"	B2WCL-G100U	\$7.42	B2WCL-R100U	8.47
1 1/2"	2.250"	2.250"	.065"	B2WCL-G150U	12.24	B2WCL-R150U	14.94
2"	3.000"	3.000"	.065"	B2WCL-G200U	19.02	B2WCL-R200U	23.77
2 1/2"	3.750"	3.750"	.065"	B2WCL-G250U	25.18	B2WCL-R250U	33.97
3"	4.500"	4.500"	.065"	B2WCL-G300U	37.37	B2WCL-R300U	47.56
4"	6.000"	6.000"	.083"	B2WCL-G400U	78.14	B2WCL-R400U	57.80
6"	9.000"	9.000"	.109"	B2WCL-G600U	320.50	B2WCL-R600U	441.66
8"	12.000"	12.000"	.120"	B2WCL-G800U	577.82	B2WCL-R800U	781.42

Unpolished 45° Long Weld Elbows with Tangents - B2KS

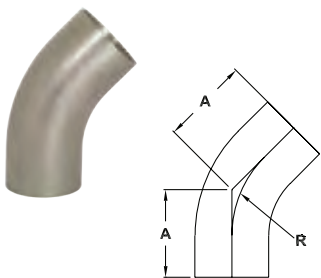

Tube OD	Dimensions		Wall Thickness	unpolished 304 Stainless Steel		unpolished 316L Stainless Steel	
	A	R		Part #	Price/E	Part #	Price/E
3/4"	2.250"	1.125"	.065"	---	---	B2KS-R75U	\$40.06
1"	1.188"	1.500"	.065"	B2KS-G100U	\$11.60	B2KS-R100U	13.60
1 1/2"	1.625"	2.250"	.065"	B2KS-G150U	16.29	B2KS-R150U	26.28
2"	2.312"	3.000"	.065"	B2KS-G200U	25.13	B2KS-R200U	31.93
2 1/2"	3.000"	3.750"	.065"	B2KS-G250U	34.65	B2KS-R250U	49.60
3"	3.688"	4.500"	.065"	B2KS-G300U	50.28	B2KS-R300U	68.19
4"	4.812"	6.000"	.083"	B2KS-G400U	47.03	B2KS-R400U	57.80

Unpolished Elbows

Unpolished 45° Weld Elbows - B2WK

Tube OD	Dimensions		Wall Thickness	unpolished 304 Stainless Steel		unpolished 316L Stainless Steel	
	A	R		Part #	Price/E	Part #	Price/E
¾"	.466"	1.125"	.065"	---	---	B2WK-R75U	\$18.33
1"	.625"	1.500"	.065"	B2WK-G100U	\$9.90	B2WK-R100U	6.80
1½"	.937"	2.250"	.065"	B2WK-G150U	8.85	B2WK-R150U	10.58
2"	1.250"	3.000"	.065"	B2WK-G200U	13.58	B2WK-R200U	17.70
2½"	1.562"	3.750"	.065"	B2WK-G250U	20.45	B2WK-R250U	27.18
3"	1.875"	4.500"	.065"	B2WK-G300U	25.84	B2WK-R300U	35.59
4"	2.500"	6.000"	.083"	B2WK-G400U	54.36	B2WK-R400U	46.12
6"	3.750"	9.000"	.109"	B2WK-G600U	279.72	B2WK-R600U	352.56
8"	5.000"	12.000"	.120"	B2WK-G800U	451.64	B2WK-R800U	577.56

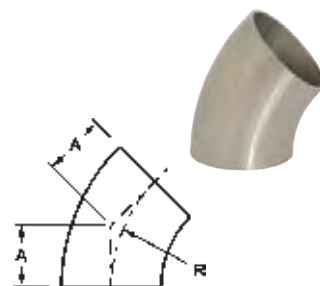

Pipe, Welding & Tube Fittings

Unpolished End Caps - B16W

Tube OD	Dimension A	unpolished 304 Stainless Steel	
		Part #	Price/E
1"	.375"	B16W-G100	\$10.29
1½"	.562"	B16W-G150	12.35
2"	.750"	B16W-G200	21.55
2½"	1.000"	B16W-G250	26.41
3"	1.250"	B16W-G300	33.82
4"	1.500"	B16W-G400	56.38

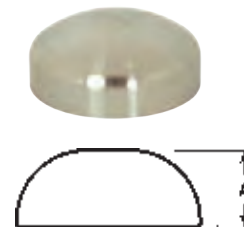

Unpolished Adapters

Male NPT x Weld End Adapters - B19WB

Tube OD	Dimension A	Wall Thickness	304 Stainless Steel	
			Part #	Price/E
1"	1.750"	.065"	B19WB-G100	\$22.02
1½"	1.750"	.065"	B19WB-G150	30.31
2"	1.812"	.065"	B19WB-G200	36.90
2½"	2.312"	.065"	B19WB-G250	58.13
3"	2.500"	.065"	B19WB-G300	77.50
4"	2.562"	.083"	B19WB-G400	142.02

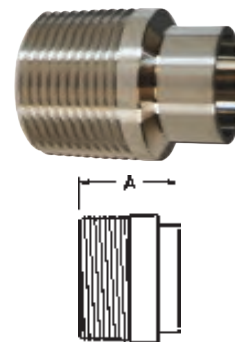

Female NPT x Weld End Adapters - B22WB

Tube OD	Dimension A	Wall Thickness	304 Stainless Steel	
			Part #	Price/E
1"	1.750"	.065"	B22WB-G100	\$45.42
1½"	1.750"	.065"	B22WB-G150	47.70
2"	1.812"	.065"	B22WB-G200	56.91
2½"	2.312"	.065"	B22WB-G250	76.15
3"	2.500"	.065"	B22WB-G300	115.41
4"	2.500"	.083"	B22WB-G400	157.60

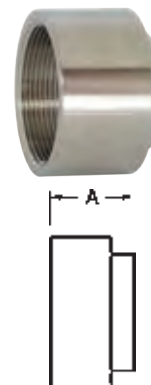

Unpolished Tees

Unpolished Short Weld Tees - B7WWW

Pipe, Welding & Tube Fittings

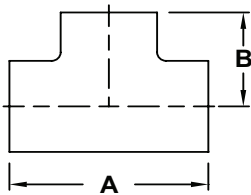

Tube OD	Dimensions		Wall Thickness	unpolished 304 Stainless Steel		unpolished 316L Stainless Steel	
	A	B		Part #	Price/E	Part #	Price/E
1"	2.250"	1.125"	.065"	B7WWW-G100U	\$10.90	B7WWW-R100U	\$12.79
1½"	3.312"	1.656"	.065"	B7WWW-G150U	15.62	B7WWW-R150U	20.07
2"	4.124"	2.062"	.065"	B7WWW-G200U	22.41	B7WWW-R200U	29.66
2½"	4.688"	2.344"	.065"	B7WWW-G250U	29.88	B7WWW-R250U	44.47
3"	5.188"	2.594"	.065"	B7WWW-G300U	40.79	B7WWW-R300U	52.66
4"	6.876"	3.438"	.083"	B7WWW-G400U	48.67	B7WWW-R400U	57.05

Unpolished Long Weld Tees - B7W

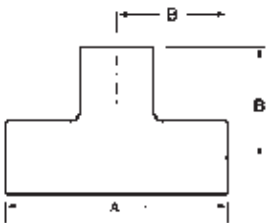

Tube OD	Dimensions		Wall Thickness	unpolished 304 Stainless Steel		unpolished 316L Stainless Steel	
	A	B		Part #	Price/E	Part #	Price/E
¾"	4.000"	2.000"	.065"	---	---	B7W-R75U	\$29.66
1"	3.750"	1.875"	.065"	B7W-G100U	\$14.83	B7W-R100U	17.76
1½"	4.500"	2.250"	.065"	B7W-G150U	20.78	B7W-R150U	24.48
2"	6.000"	3.000"	.065"	B7W-G200U	29.90	B7W-R200U	40.03
2½"	6.000"	3.000"	.065"	B7W-G250U	38.54	B7W-R250U	61.15
3"	6.500"	3.250"	.065"	B7W-G300U	51.91	B7W-R300U	62.25
4"	7.750"	3.875"	.083"	B7W-G400U	63.97	B7W-R400U	62.66

Unpolished Reducing Weld Tees - B7RWWW



Tube OD	Wall Thickness	unpolished 304 Stainless Steel		unpolished 316L Stainless Steel	
		Part #	Price/E	Part #	Price/E
1½" x 1"	.065"	B7RWWW-G150100U	\$18.60	B7RWWW-R150100U	\$26.02
2" x 1"	.065"	B7RWWW-G200100U	26.71	B7RWWW-R200100U	31.88
2" x 1½"	.065"	B7RWWW-G200150U	27.48	B7RWWW-R200150U	31.88
2½" x 1½"	.065"	B7RWWW-G250150U	34.13	B7RWWW-R250150U	48.25
2½" x 2"	.065"	B7RWWW-G250200U	34.13	B7RWWW-R250200U	42.31
3" x 1½"	.065"	B7RWWW-G300150U	48.96	B7RWWW-R300150U	57.13
3" x 2"	.065"	B7RWWW-G300200U	48.96	B7RWWW-R300200U	57.84
4" x 2"	.083"	B7RWWW-G400200U	63.97	B7RWWW-R400200U	75.19
4" x 3"	.083"	B7RWWW-G400300U	63.97	B7RWWW-R400300U	75.19

Dimensions

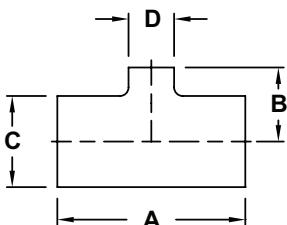

A	B	C	D
3.312"	1.375"	1.500"	1.000"
4.124"	1.625"	2.000"	1.000"
4.124"	1.906"	2.000"	1.500"
4.688"	2.156"	2.500"	1.500"
4.688"	2.312"	2.500"	2.000"
5.188"	2.406"	3.000"	1.500"
5.188"	2.562"	3.000"	2.000"
6.876"	3.062"	4.000"	2.000"
6.876"	3.094"	4.000"	3.000"

Unpolished Weld Reducers

Unpolished Concentric Weld Reducers - B31W

Tube OD	Dimension A	Wall Thickness	unpolished 304 Stainless Steel		unpolished 316L Stainless Steel	
			Part #	Price/E	Part #	Price/E
¾" x ½"	1.000"	.065"	---	---	B31W-R7550U	\$22.23
1" x ½"	2.000"	.065"	---	---	B31W-R10050U	34.77
1" x ¾"	1.000"	.065"	---	---	B31W-R10075U	22.23
1½" x ¾"	3.000"	.065"	---	---	B31W-R15075U	32.59
1½" x 1"	2.000"	.065"	B31W-G150100U	\$19.27	B31W-R150100U	20.76
2" x 1"	4.000"	.065"	B31W-G200100U	40.76	B31W-R200100U	48.96
2" x 1½"	2.000"	.065"	B31W-G200150U	21.50	B31W-R200150U	23.71
2½" x 1½"	4.000"	.065"	B31W-G250150U	48.19	B31W-R250150U	51.89
2½" x 2"	2.000"	.065"	B31W-G250200U	24.46	B31W-R250200U	28.90
3" x 1½"	6.000"	.065"	B31W-G300150U	82.89	B31W-R300150U	92.72
3" x 2"	4.000"	.065"	B31W-G300200U	39.81	B31W-R300200U	46.93
3" x 2½"	2.000"	.065"	B31W-G300250U	31.28	B31W-R300250U	35.59
4" x 2"	8.000"	.083"	B31W-G400200U	107.48	B31W-R400200U	114.20
4" x 2½"	6.000"	.083"	B31W-G400250U	89.02	B31W-R400250U	103.85
4" x 3"	4.000"	.083"	B31W-G400300U	41.37	B31W-R400300U	59.79
6" x 4"	5.500"	.109"	B31W-G600400U	203.99	B31W-R600400U	259.58

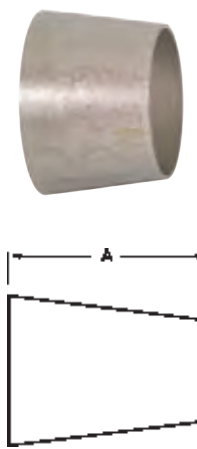

Unpolished Eccentric Weld Reducers - B32W

Tube OD	Dimension A	Wall Thickness	unpolished 304 Stainless Steel		unpolished 316L Stainless Steel	
			Part #	Price/E	Part #	Price/E
1" x ½"	2.000"	.065"	---	---	B32W-R10050U	\$46.71
2" x 1"	4.000"	.065"	B32W-G200100U	\$53.36	B32W-R200100U	57.84
2" x 1½"	2.000"	.065"	B32W-G200150U	30.39	B32W-R200150U	32.62
2½" x 2"	2.000"	.065"	B32W-G250200U	36.36	B32W-R250200U	37.06
3" x 2"	4.000"	.065"	B32W-G300200U	61.84	B32W-R300200U	66.72
3" x 2½"	2.000"	.065"	B32W-G300250U	48.96	B32W-R300250U	48.25
4" x 2"	8.000"	.083"	B32W-G400200U	133.42	B32W-R400200U	137.20
4" x 3"	4.000"	.083"	B32W-G400300U	63.20	B32W-R400300U	74.19

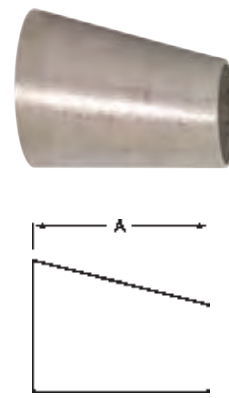

Unpolished Type A Stub Ends - 14VB

Application:

- typically used with B38SL flanges

Tube OD	Dimensions				316L Stainless Steel	
	A	B	C	D	Part #	Price/E
1"	1.625"	2.000"	1.000"	.065"	14VB-R100	\$48.25
1½"	1.750"	2.875"	1.500"	.065"	14VB-R150	74.75
2"	1.500"	3.625"	2.000"	.065"	14VB-R200	112.79
2½"	2.000"	4.125"	2.500"	.065"	14VB-R250	149.49
3"	2.250"	5.000"	3.000"	.065"	14VB-R300	183.46
4"	2.625"	6.187"	4.000"	.084"	14VB-R400	298.97
6"	3.000"	8.500"	6.000"	.109"	14VB-R600	787.85
8"	3.000"	10.625"	8.000"	.120"	14VB-R800	740.38

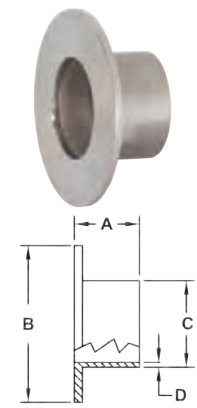

Unpolished Miscellaneous Configurations

Pipe, Welding & Tube Fittings

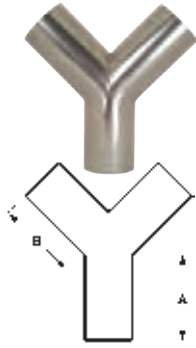

Unpolished Weld True Wyes - B28W

Tube OD	Dimensions		Wall Thickness	unpolished 316L Stainless Steel	
	A	B		Part #	Price/E
1"	2.000"	2.438"	.065"	B28W-R100U	\$351.12
1½"	2.000"	2.438"	.065"	B28W-R150U	155.00
2"	2.625"	3.250"	.065"	B28W-R200U	378.24
2½"	3.370"	4.125"	.065"	B28W-R250U	660.79
3"	4.000"	4.875"	.065"	B28W-R300U	489.08
4"	5.375"	5.375"	.083"	B28W-R400U	319.95

Unpolished Weld Laterals - B28WA

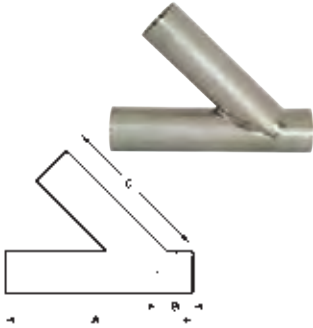

Tube OD	Dimensions			Wall Thickness	unpolished 316L Stainless Steel	
	A	B	R		Part #	Price/E
1"	6.000"	1.000"	5.000"	.065"	B28WA-R100U	\$397.82
1½"	7.375"	1.188"	6.188"	.065"	B28WA-R150U	460.24
2"	8.750"	1.625"	7.125"	.065"	B28WA-R200U	192.52
2½"	10.000"	1.500"	8.500"	.065"	B28WA-R250U	378.16
3"	10.750"	1.875"	8.875"	.065"	B28WA-R300U	387.69
4"	12.812"	2.015"	10.750"	.083"	B28WA-R400U	319.95

Unpolished Weld 180° Return Bends - B2WUL

Feature:

- bends are standard 1.5 x tube diameter

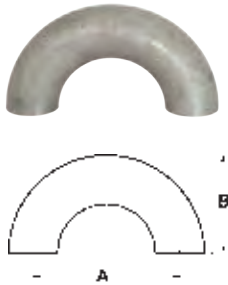

Tube OD	Dimensions		Wall Thickness	unpolished 316L Stainless Steel	
	A	B		Part #	Price/E
1"	3.000"	2.000"	.065"	B2WUL-R100U	\$43.91
1½"	4.500"	3.000"	.065"	B2WUL-R150U	60.12
2"	6.000"	4.000"	.065"	B2WUL-R200U	76.76
3"	9.000"	6.000"	.065"	B2WUL-R300U	174.25
4"	12.000"	8.000"	.083"	B2WUL-R400U	292.06

See page J-176 for weld end protection covers.

Flanges

Unpolished Slip-On 150# Flanges - B38SL

Tube OD	Dimensions			Number / Diameter Bolt Holes	Bolt Circle	304 Stainless Steel		316L Stainless Steel	
	A	B	C			Part #	Price/E	Part #	Price/E
1"	.375"	4.250"	1.063"	4/.625"	3.125"	B38SL-G100	\$53.86	B38SL-R100	\$62.03
1½"	.375"	5.000"	1.563"	4/.625"	3.875"	B38SL-G150	64.18	B38SL-R150	74.63
2"	.437"	6.000"	2.063"	4/.750"	4.750"	B38SL-G200	86.75	B38SL-R200	101.56
3"	.500"	7.500"	3.063"	4/.750"	6.000"	B38SL-G300	136.25	B38SL-R300	166.29
4"	.562"	9.000"	4.063"	8/.750"	7.500"	B38SL-G400	181.73	B38SL-R400	225.42
6"	.562"	11.000"	6.063"	8/.875"	9.500"	B38SL-G600	244.52	B38SL-R600	296.93
8"	.687"	13.500"	8.063"	8/.875"	11.750"	B38SL-G800	747.79	B38SL-R800	951.73

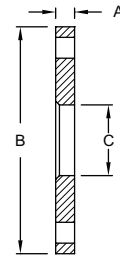
Pipe, Welding
& Tube Fittings

Unpolished Weld Neck Flanges - B38W

Tube OD	Dimensions				Number / Diameter Bolt Holes	Bolt Circle	316L Stainless Steel	
	A	B	C	D			Part #	Price/E
1"	.375"	4.250"	1.000"	.500"	4/.625"	3.125"	B38W-R100	\$224.36
1½"	.375"	5.000"	1.500"	.500"	4/.625"	3.875"	B38W-R150	263.27
2"	.500"	6.000"	2.000"	.625"	4/.750"	4.750"	B38W-R200	390.54
2½"	.500"	7.000"	2.500"	.625"	4/.750"	5.500"	B38W-R250	526.35
3"	.500"	7.500"	3.000"	.625"	4/.750"	6.000"	B38W-R300	623.93
4"	.500"	9.000"	4.000"	.625"	8/.750"	7.500"	B38W-R400	811.69
6"	.500"	11.000"	6.000"	.625"	8/.875"	9.500"	B38W-R600	2562.00
8"	.500"	13.500"	8.000"	.625"	8/.875"	11.750"	B38W-R800	3519.80

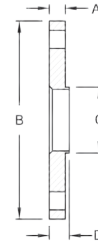

- For flange dimensions, diagrams and additional information please reference dixonvalve.com.

Spray Balls

Rotating Spray Balls - SRH

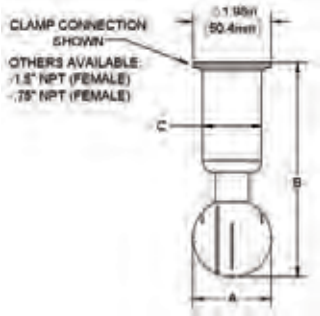

Application:

- ideal for cleaning all types of tanks and vessels

Features:

- stainless steel ball bearings eliminate rust
- cleaning solution lubricates unit
- mirror-like finish (OD)
- spray pattern: 360°
- available connections: clamp and NPT

Size	Type	304 Stainless Steel		316L Stainless Steel	
		Part #	Price/E	Part #	Price/E
3/4"	NPT	SRH360NPT-G075	\$144.04	---	---
1 1/2"	NPT	---	---	SRH360NPT-R150	\$315.52
1 1/2"	clamp	SRH360CMP-G150	153.64	SRH360CMP-R150	207.41

Stationary Spray Balls - STC

Application:

- typically used in food and beverage industries for cleaning storage tanks

Features:

- heavy duty 316L stainless steel construction provides longer life
- stationary - designed to be mounted to a tube or pipe
- 2 mm spray holes
- various spray patterns available (blanks available as special order)

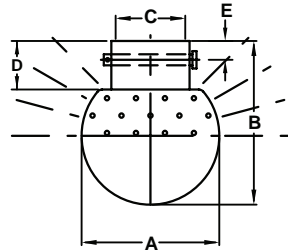

180° Top Pattern

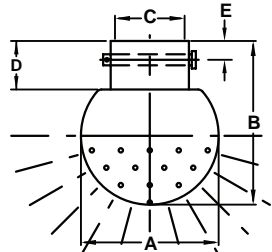

180° Bottom Pattern

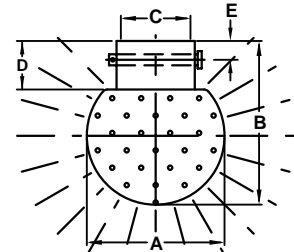

360° Pattern

Size	Pin Length	Spray Pattern	Dimensions					Pin Size	316L Stainless Steel	
			A	B	C	D	E		Part #	Price/E
1"	1.47"	360°	3.04"	2.95"	1.005"	.975"	.445"	.226"	STC-360-R100	\$123.92
1 1/2"	1.95"	360°	3.54"	2.95"	1.505"	.975"	.445"	.226"	STC-360-R150	191.14
1"	1.47"	180° bottom	3.54"	2.95"	1.005"	.975"	.445"	.226"	STC-180B-R100	126.11
1 1/2"	1.95"	180° bottom	3.54"	2.95"	1.505"	.975"	.445"	.226"	STC-180B-R150	180.17
1"	1.47"	180° top	3.54"	2.95"	1.005"	.975"	.445"	.226"	STC-180T-R100	126.11
1 1/2"	1.95"	180° top	3.54"	2.95"	1.505"	.975"	.445"	.226"	STC-180T-R150	180.17

Repair Kits

Repair kit contains:

- (1) pin
- (1) R clip

Size	Part #	Price/E
1"	STC-RK100	\$9.04
1 1/2"	STC-RK150	9.22

Sight Glasses

Features:

- size range: 1" - 6" OD tube
- finish: 32R_a sanitary finish, ID and OD

In-Line Sight Glasses - B54BMP

Features:

- clamp, weld, bevel seat, John Perry, I-Line and Q-Line configurations are available
- maximum temperature: **200°F (93°C)**

Tube OD	Dimensions		Working Pressure PSI	316L Stainless Steel	
	A	B		Part #	Price/E
1"	5.625"	3.250"	145	B54BMP-R100	\$573.46
1½"	5.625"	4.000"	145	B54BMP-R150	651.08
2"	5.625"	4.250"	145	B54BMP-R200	689.97
2½"	6.125"	4.750"	120	B54BMP-R250	884.15
3"	7.250"	5.500"	120	B54BMP-R300	1039.10
4"	7.375"	6.500"	95	B54BMP-R400	1243.51
6"	7.625"	9.500"	80	B54BMP-R600	6179.50

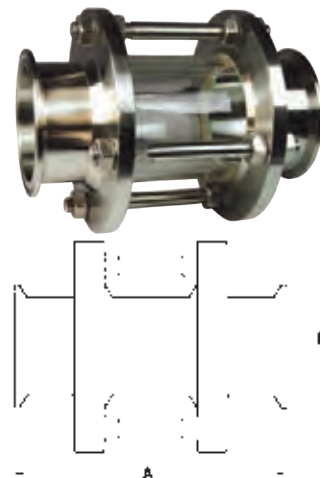

Pipe, Welding
& Tube Fittings

Seal Kit

Seal kit contains:
(2) black buna gaskets

Size	White Buna	
	Part #	Price/E
1"	B54BMP-SK100	\$10.26
1½"	B54BMP-SK150	10.26
2"	B54BMP-SK200	10.26
2½"	B54BMP-SK250	13.81
3"	B54BMP-SK300	13.81
4"	B54BMP-SK400	13.81
6"	B54BMP-SK600	POR



Replacement Glass

Size	Borosilicate glass	
	Part #	Price/E
1"	B54G-P100	\$284.22
1½"	B54G-P150	329.94
2"	B54G-P200	351.66
2½"	B54G-P250	451.49
3"	B54G-P300	534.29
4"	B54G-P400	635.08
6"	B54G-P600	POR



Sight Glass End Caps - B5416MP

Features:

- for use on any line with a clamp and gasket
- maximum temperature: **150°F (66°C)**
- maximum operating pressure: **100 PSI**

Tube OD	Dimensions		Acrylic	
	A	B	Part #	Price/E
1" - 1½"	.438"	1.984"	B5416MP-A100150	\$74.31
2"	.438"	2.516"	B5416MP-A200	131.80
2½"	.438"	3.047"	B5416MP-A250	123.85
3"	.438"	3.579"	B5416MP-A300	162.17
4"	.438"	4.682"	B5416MP-A400	326.92
6"	.438"	6.562"	B5416MP-A600	705.13

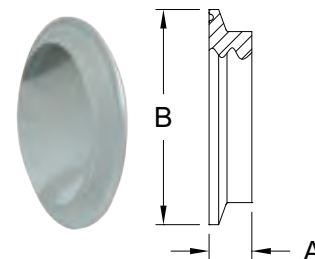

Compact Sight Glasses

Applications:

- Used widely in the food, dairy and beverage sanitary processes to view products and fluids.

Features:

- easier to clean than bolted styles
- less costly to repair than bolted styles
- clamp connections standard
- maximum temperature: **200°F (93°C)**
- maximum pressure: **100 PSI**

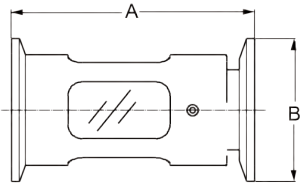

Tube OD	Dimensions		Borosilicate Glass	
	A	B	Part #	Price/E
1"	3.375"	1.980"	B54BMPS-R100	\$156.16
1½"	3.640"	1.980"	B54BMPS-R150	236.92
2"	3.830"	2.516"	B54BMPS-R200	258.47
3"	4.130"	3.800"	B54BMPS-R300	443.60
4"	4.340"	4.680"	B54BMPS-R400	647.44

Tube OD	Dimensions		Lexan™	
	A	B	Part #	Price/E
1"	3.375"	1.980"	B54BMPLX-R100	\$231.32
1½"	3.640"	1.980"	B54BMPLX-R150	285.99
2"	3.830"	2.516"	B54BMPLX-R200	298.95
3"	4.130"	3.800"	B54BMPLX-R300	591.76
4"	4.340"	4.680"	B54BMPLX-R400	820.98

Seal Kits



Size	Buna-N	
	Part #	Price/E
1"	B54BMPS-SK100	\$10.26
1½"	B54BMPS-SK150	8.52
2"	B54BMPS-SK200	8.52
3"	B54BMPS-SK300	12.11
4"	B54BMPS-SK400	25.44

Replacement Glass



Size	Borosilicate glass	
	Part #	Price/E
1"	B54BMPS-GL100	\$60.90
1½"	B54BMPS-GL150	95.06
2"	B54BMPS-GL200	129.31
3"	B54BMPS-GL300	154.80
4"	B54BMPS-GL400	325.10

Swivels

Features:

- available in clamp and weld configurations
- elastomers: silicone and PTFE standard, optional elastomers available
- finish: sanitary finish ID and OD

straight swivel clamp - style 20

Size	Dimensions			Pressure Rating PSI @ 70°F (21°C)	Pressure Rating PSI @ 250°F (121°C)	316L Stainless Steel	
	A	B	C			Part #	Price/E
1"	2.56"	3.00"	1.00"	500	300	<i>SJSS100CC-20</i>	\$1800.15
1½"	2.56"	3.00"	1.50"	500	300	<i>SJSS150CC-20</i>	1853.74
2"	3.09"	3.00"	2.00"	450	250	<i>SJSS200CC-20</i>	2156.87
2½"	3.44"	3.00"	2.50"	400	200	<i>SJSS250CC-20</i>	3824.20
3"	3.94"	3.00"	3.00"	350	175	<i>SJSS300CC-20</i>	4439.59
4"	5.08"	4.19"	4.00"	300	150	<i>SJSS400CC-20</i>	7974.76

straight weld connection - style 20

Size	Dimensions			Pressure Rating PSI @ 70°F (21°C)	Pressure Rating PSI @ 250°F (121°C)	316L Stainless Steel	
	A	B	C			Part #	Price/E
1"	2.56"	2.00"	1.00"	500	300	<i>SJSS100BB-20</i>	\$1764.92
1½"	2.56"	2.00"	1.50"	500	300	<i>SJSS150BB-20</i>	2953.97
2"	3.09"	2.00"	2.00"	450	250	<i>SJSS200BB-20</i>	2038.08
2½"	3.44"	2.00"	2.50"	400	200	<i>SJSS250BB-20</i>	3008.10
3"	3.94"	2.00"	3.00"	350	175	<i>SJSS300BB-20</i>	4236.64
4"	5.08"	2.94"	4.00"	300	150	<i>SJSS400BB-20</i>	8473.63

- dimensional information can be found at dixonvalve.com



Pipe, Welding
& Tube Fittings

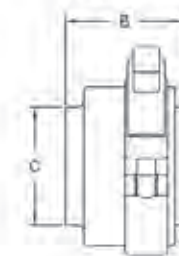
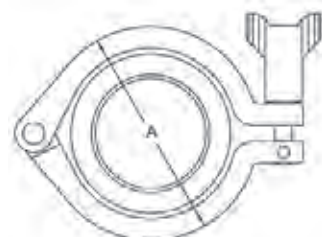

Sanitary 3½" Pressure Gauges

Features:

- accuracy: ± 1.5% of full scale
- over range capacity: 30%
- wetted surfaces: 316L stainless steel
- surface finishes (wetted parts): R_a max = 25 microinches
- case material: 304 stainless steel
- dial size: 3½"
- lens material: polycarbonate
- temperature range: 0°F (-18°C) to 250°F (121°C)
- standard fill: food grade glycerin
- rezero feature: standard on pointer
- shipping weight: approximately 3 lbs. (1.3 kg)

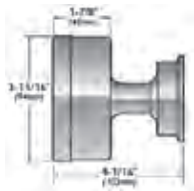
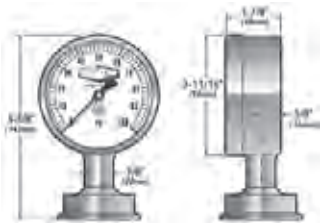

Dial Size	Clamp Size	Pressure Range (PSI)	Mount	316L Stainless Steel	
				Part #	Price/E
3½"	1½"	0-30	bottom	3S-B-15U-GFBTSS	\$1047.14
	1½"	0-60	bottom	3S-C-15U-GFBTSS	1047.14
	1½"	0-100	bottom	3S-D-15U-GFBTSS	1047.14
	1½"	0-160	bottom	3S-E-15U-GFBTSS	1047.14
	1½"	0-200	bottom	3S-F-15U-GFBTSS	1047.14
	1½"	0-300	bottom	3S-G-15U-GFBTSS	1047.14
	1½"	0-30	back	3S-B-15U-GFBKSS	1047.14
	1½"	0-60	back	3S-C-15U-GFBKSS	1047.14
	1½"	0-100	back	3S-D-15U-GFBKSS	1047.14
	1½"	0-160	back	3S-E-15U-GFBKSS	1047.14
	1½"	0-200	back	3S-F-15U-GFBKSS	1047.14
	1½"	0-300	back	3S-G-15U-GFBKSS	1047.14
	2"	0-30	bottom	3S-B-2U-GFBTSS	1047.14
	2"	0-60	bottom	3S-C-2U-GFBTSS	1047.14
	2"	0-100	bottom	3S-D-2U-GFBTSS	1047.14
	2"	0-160	bottom	3S-E-2U-GFBTSS	1047.14
	2"	0-200	bottom	3S-F-2U-GFBTSS	1047.14
	2"	0-300	bottom	3S-G-2U-GFBTSS	1047.14
	2"	0-30	back	3S-B-2U-GFBKSS	1047.14
	2"	0-60	back	3S-C-2U-GFBKSS	1047.14
	2"	0-100	back	3S-D-2U-GFBKSS	1047.14
	2"	0-160	back	3S-E-2U-GFBKSS	1047.14
	2"	0-200	back	3S-F-2U-GFBKSS	1047.14
	2"	0-300	back	3S-G-2U-GFBKSS	1047.14



Strainers

In-line Strainer - BSCCQ

Features:

- ships standard with: spring, distributor cap, clamp gasket, 1/4" perforated back-up tube, squeeze clamp, inlet and outlet bodies
- must be vertically mounted to be 3A compliant
- bevel seat, I-line and weld ends available, call Dixon® for information
- 1/8" perforated back-up tube available, must specify when ordering (not 3A)

short

Size	Dimensions		316L Stainless Steel	
	A	B	Part #	Price/E
1"	15.75"	4.00"	BSCCQ1-R100	\$1448.47
1½"	15.75"	4.00"	BSCCQ1-R150	1448.47
2"	15.75"	4.00"	BSCCQ1-R200	1448.47
2½"	15.75"	4.50"	BSCCS1-R250	1709.69
3"	15.75"	4.50"	BSCCS1-R300	1709.69

long

Size	Dimensions		316L Stainless Steel	
	A	B	Part #	Price/E
1½"	35.375"	4.00"	BSCCQ2-R150	\$2561.39
2"	35.375"	4.00"	BSCCQ2-R200	2561.39
3"	35.375"	4.50"	BSCCS2-R300	3129.94



short

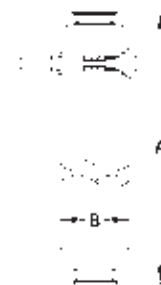

Side-Entry Strainer - BSCCQ

Features:

- ships standard with: spring, end cap with handle, distributor cap, clamp gasket, 1/4" perforated back-up tube, body and squeeze clamp
- serviceable without removing from the line
- must be a vertically mounted to be 3A compliant
- bevel seat, I-line and weld ends available, call Dixon® for information
- 1/8" perforated back-up tube available, must specify when ordering (not 3A certified)

Size	Dimensions				316L Stainless Steel	
	A	B	C	D	Part #	Price/E
1½"	41.90"	4.00"	35.00"	3.50"	BSCCQ3-R150	\$3322.92
2"	41.90"	4.00"	35.00"	3.50"	BSCCQ3-R200	3322.92
3"	41.90"	4.50"	35.00"	3.75"	BSCCQ3-R300	4092.37

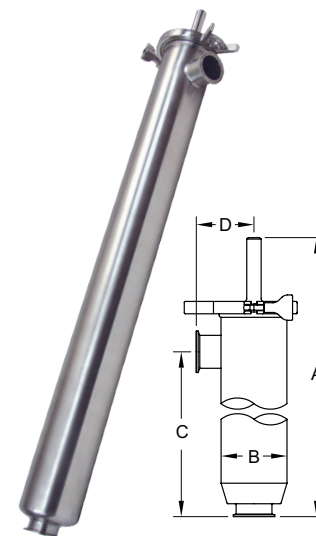

Side-Outlet Reverse Strainer - BSCCQ

Features:

- ships standard with: spring, end cap with handle, distributor cap, clamp gasket, 1/4" perforated back-up tube, body and squeeze clamp
- 1/8" perforated back-up tube available (not 3A certified)
- bevel seat, I-line and weld ends available, call Dixon® for information
- can be serviced in-line

Size	Dimensions				316L Stainless Steel	
	A	B	C	D	Part #	Price/E
1½"	41.90"	4.00"	35.00"	3.50"	BSCCQ4-R150	\$3209.12
2"	41.90"	4.00"	35.00"	3.50"	BSCCQ4-R200	3209.12
3"	41.90"	4.50"	35.00"	3.75"	BSCCQ4-R300	3938.74

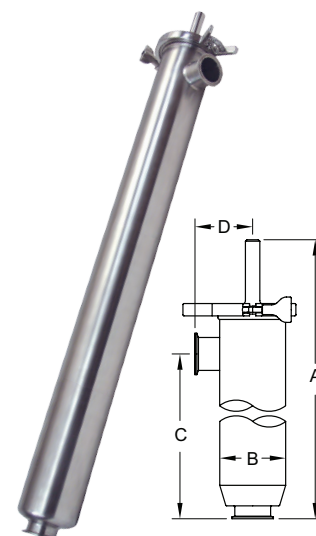

Strainers

Filters

Features:

- filter medium are special order and minimum quantities apply, not included with base unit
- filters require retaining ring

short

Size	Micron Rating	Description	Part #	Price/E
1" - 2"	38	nonwoven rayon (glued seam)	BF30A-100-200	\$238.84
2½" - 3"	38	nonwoven rayon (glued seam)	BF30A-250-300	173.92
1" - 2"	513	woven knapped cotton flannel	BF30B-100-200	472.38
2½" - 3"	513	woven knapped cotton flannel	BF30B-250-300	455.85
1" - 2"	300	cheese cloth, single thickness cotton	BF30C-100-200	188.85
2½" - 3"	300	cheese cloth, single thickness cotton	BF30C-250-300	239.38
1" - 2"	765	nylon, 26/29 mesh, rectangular opening, (.025 x .030)	BF30D-100-200	387.31
2½" - 3"	765	nylon, 26/29 mesh, rectangular opening, (.025 x .030)	BF30D-250-300	387.62
1" - 2"	40-42	nonwoven rayon	BF30E-100-200	337.15
2½" - 3"	40-42	nonwoven rayon	BF30E-250-300	192.69
1" - 2"	40	nonwoven rayon	BF30F-100-200	295.77
1" - 2"	420	woven nylon, 40 mesh	BF30G-100-200	317.69
2½" - 3"	420	woven nylon, 40 mesh	BF30G-250-300	257.99

long

Size	Micron Rating	Description	Part #	Price/E
1" - 2"	40-42	nonwoven rayon	BF302E-100-200	\$473.84
2½" - 3"	40-42	nonwoven rayon	BF302E-250-300	823.65
2½" - 3"	420	woven nylon, 40 mesh	BF302G-250-300	398.92

316 Stainless Wire Cloth Mesh Over Screens

Features:

- not all sizes are stocked, additional sizes are available (5 piece minimum), call Dixon®
- not 3A compatible, not included with base unit

Size	Micron Rating	Square Mesh	Space Between Wires	Percent of Open Area	Short Part #	Price/E	Long Part #	Price/E
1" - 2"	864	20	0.034"	46.2	BS20-100-200	\$106.53	BS202-100-200	\$190.39
2½" - 3"	864	20	0.034"	46.2	BS20-250-300	111.92	BS202-250-300	198.47
1" - 2"	381	40	0.015"	36.0	BS40-100-200	106.53	BS402-100-200	190.39
2½" - 3"	381	40	0.015"	36.0	BS40-250-300	111.92	BS402-250-300	198.47
1" - 2"	229	60	0.009"	30.3	BS60-100-200	106.53	BS602-100-200	190.39
2½" - 3"	229	60	0.009"	30.3	BS60-250-300	111.92	BS602-250-300	198.47
1" - 2"	178	80	0.007"	31.4	BS80-100-200	106.53	BS802-100-200	190.39
2½" - 3"	178	80	0.007"	31.4	BS80-250-300	111.92	BS802-250-300	198.47
1" - 2"	140	100	0.006"	30.3	BS100-100-200	106.53	BS1002-100-200	190.39
2½" - 3"	140	100	0.006"	30.3	BS100-250-300	101.75	BS1002-250-300	198.47

Pressure Drop Curves for Filter and Strainer

- water at ambient temperature
- maximum flow for short units is 125 GPM
- maximum flow for long units is 175 GPM

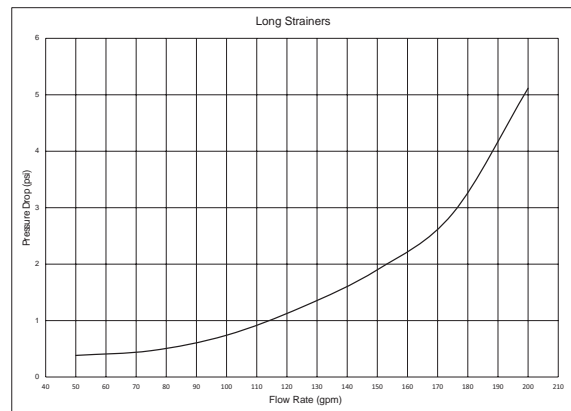
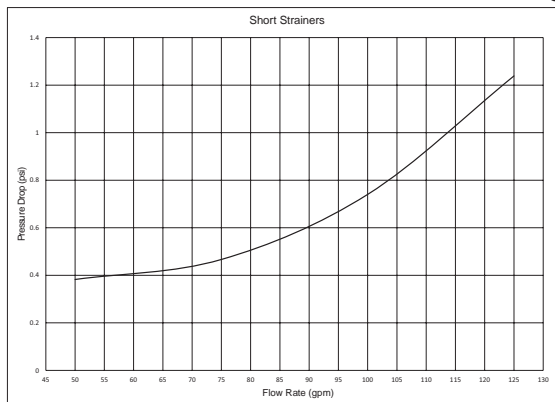

Tube Hangers

Hex Tube Hanger with ABS Sleeve - B24PS

Feature:

- maximum temperature: 230°F (110°C)

Tube OD	Dimensions		304 Stainless Steel	
	A	B	Part #	Price/E
1/2"	2.800"	1.150"	B24PS-G50	\$9.26
3/4"	2.800"	1.150"	B24PS-G75	9.26
1"	3.425"	1.450"	B24PS-G100	12.93
1 1/2"	4.000"	2.125"	B24PS-G150	14.07
2"	4.500"	2.500"	B24PS-G200	16.89
2 1/2"	4.950"	3.125"	B24PS-G250	19.66
3"	5.500"	3.750"	B24PS-G300	22.41
4"	6.950"	4.750"	B24PS-G400	29.21
5"	8.063"	5.625"	B24PS-G500	92.88
6"	9.250"	6.625"	B24PS-G600	60.90
8"	11.500"	8.625"	B24PS-G800	106.81

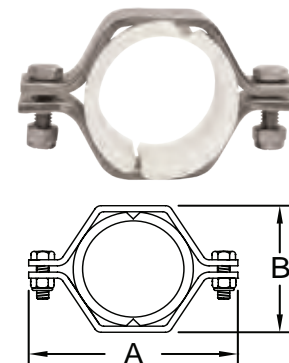

Pipe, Welding
& Tube Fittings

Sleeves - 13PS

Features:

- maximum temperature: 230°F (110°C)
- high temperature sleeves are also available, contact Dixon®

Size	ABS	
	Part #	Price/E
1/2"	13PS-50	\$4.19
3/4"	13PS-75	4.19
1"	13PS-100	4.69
1 1/2"	13PS-150	4.69
2"	13PS-200	4.69
2 1/2"	13PS-250	7.27
3"	13PS-300	7.75
4"	13PS-400	9.37
5"	13PS-500	60.90
6"	13PS-600	15.83
8"	13PS-800	22.94



Hex Tube Hanger with Nitrile Grommets - B24RG

Features:

- replacement grommets are available, contact Dixon®
- nitrile grommets; maximum temperature: 230°F (110°C)

Tube OD	Dimensions		304 Stainless Steel	
	A	B	Part #	Price/E
1/2" - 3/4"	3.425"	1.450"	B24RG-G75	\$11.58
1"	3.425"	1.450"	B24RG-G100	12.65
1 1/2"	4.000"	2.125"	B24RG-G150	13.60
2"	4.500"	2.500"	B24RG-G200	16.48
2 1/2"	4.950"	3.125"	B24RG-G250	18.58
3"	5.500"	3.750"	B24RG-G300	21.20
4"	6.950"	4.750"	B24RG-G400	27.46
5"	8.000"	5.625"	B24RG-G500	51.60
6"	9.250"	6.625"	B24RG-G600	47.38
8"	11.500"	8.625"	B24RG-G800	87.59

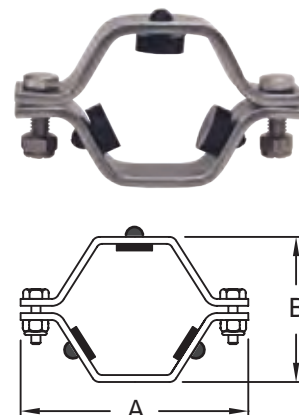

Tube Hangers

Round Tube Hangers with Nitrile Inserts - B24RPH

Feature:

- Nitrile inserts
- maximum temperature: 230°F (110°C)

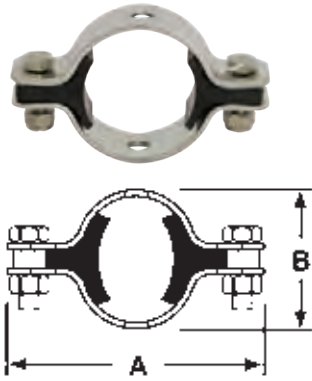

Tube OD	Dimensions		304 Stainless Steel	
	A	B	Part #	Price/E
1/2"	2.750"	1.125"	B24RPH-G50	\$12.63
3/4"	2.750"	1.125"	B24RPH-G75	12.63
1"	3.310"	1.500"	B24RPH-G100	20.19
1 1/2"	3.810"	2.000"	B24RPH-G150	21.51
2"	4.250"	2.562"	B24RPH-G200	24.89
2 1/2"	5.000"	3.000"	B24RPH-G250	27.61
3"	5.500"	3.562"	B24RPH-G300	31.07
4"	6.500"	4.688"	B24RPH-G400	39.21

Nuts and Bolts - 13NHN

Features:

- hex hangers with grommets and round hangers 1" to 4" use 13NHN-G100-600 fastener sets
- 1/2" and 3/4" round and sleeved hangers use 13NHN-G75 fastener sets
- 2 nuts and bolts supplied to a set

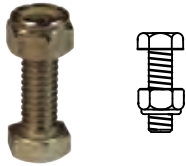

Size	Description	304 Stainless Steel	
		Part #	Price/E
1/2" - 3/4"	1/4"-20 x 3/4" bolt with nylock nut	13NHN-G75	\$2.36
1" - 12"	5/16"-18 x 1" bolt with nylock nut	13NHN-G100-600	1.54

Wall Flanges - B25

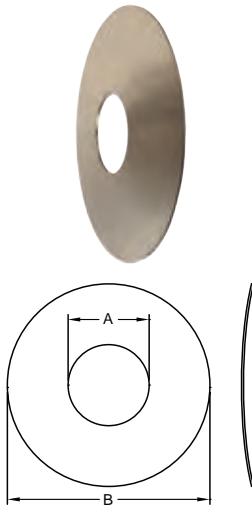

Tube OD	Dimensions		Wall Thickness	304 Stainless Steel	
	A	B		Part #	Price/E
1/2"	.50"	3.00"	.065"	B25-G050300	\$30.64
1/2"	.50"	5.00"	.065"	B25-G050500	32.05
3/4"	.75"	3.00"	.065"	B25-G075300	27.95
3/4"	.75"	5.00"	.065"	B25-G075500	33.65
1"	1.00"	3.00"	.065"	B25-G100300	25.38
1"	1.00"	5.00"	.065"	B25-G100500	28.43
1 1/2"	1.50"	5.00"	.065"	B25-G150500	29.16
2"	2.00"	5.00"	.065"	B25-G200500	29.80
2 1/2"	2.50"	5.00"	.065"	B25-G250500	30.44
3"	3.00"	6.00"	.065"	B25-G300600	30.84
4"	4.00"	7.00"	.065"	B25-G400700	37.75
6"	6.00"	10.00"	.065"	B25-G6001000	161.80
8"	8.00"	12.00"	.065"	B25-G8001200	212.89
10"	10.00"	14.00"	.065"	B25-G10001400	256.67
12"	12.00"	16.00"	.065"	B25-G12001600	270.31

High Purity BioPharm Fittings

63-03
621

Pipe, Welding
& Tube Fittings

90° Weld Elbows - T2S

Size	Dimension A	PL finish - SF1		PM finish - SF4	
		Part #	Price/E	Part #	Price/E
1/2"	3.00"	T2S-050PL	\$43.01	T2S-050PM	\$58.46
3/4"	3.00"	T2S-075PL	38.98	T2S-075PM	54.50
1"	3.00"	T2S-100PL	36.54	T2S-100PM	65.46
1 1/2"	3.75"	T2S-150PL	45.25	T2S-150PM	65.46
2"	4.75"	T2S-200PL	57.95	T2S-200PM	80.07
2 1/2"	5.50"	T2S-250PL	84.04	T2S-250PM	117.31
3"	6.25"	T2S-300PL	121.79	T2S-300PM	158.72
4"	8.00"	T2S-400PL	229.48	T2S-400PM	270.38



BPE Table DT-4.1.1-1

90° Clamp x Weld Elbows - T2CM

Size	Dimensions		PL finish - SF1		PM finish - SF4	
	A	B	Part #	Price/E	Part #	Price/E
1/2"	3.00"	1.625"	T2CM-050PL	\$63.21	T2CM-050PM	\$81.73
3/4"	3.00"	1.625"	T2CM-075PL	58.33	T2CM-075PM	76.99
1"	3.00"	2.000"	T2CM-100PL	56.28	T2CM-100PM	78.47
1 1/2"	3.75"	2.750"	T2CM-150PL	64.42	T2CM-150PM	88.85
2"	4.75"	3.500"	T2CM-200PL	86.08	T2CM-200PM	112.05
2 1/2"	5.50"	4.250"	T2CM-250PL	119.10	T2CM-250PM	156.21
3"	6.25"	5.000"	T2CM-300PL	155.20	T2CM-300PM	195.89
4"	8.00"	6.625"	T2CM-400PL	258.65	T2CM-400PM	258.65



BPE Table DT-4.1.1-2

90° Clamp x Clamp Elbows - T2CMP

Size	Dimension A	PL finish - SF1		PM finish - SF4	
		Part #	Price/E	Part #	Price/E
1/2"	1.625"	T2CMP-050PL	\$67.95	T2CMP-050PM	\$90.97
3/4"	1.625"	T2CMP-075PL	68.52	T2CMP-075PM	91.61
1"	2.000"	T2CMP-100PL	67.11	T2CMP-100PM	92.25
1 1/2"	2.750"	T2CMP-150PL	73.21	T2CMP-150PM	102.11
2"	3.500"	T2CMP-200PL	98.91	T2CMP-200PM	129.49
2 1/2"	4.250"	T2CMP-250PL	129.49	T2CMP-250PM	170.96
3"	5.000"	T2CMP-300PL	169.11	T2CMP-300PM	214.10
4"	6.625"	T2CMP-400PL	248.01	T2CMP-400PM	297.82

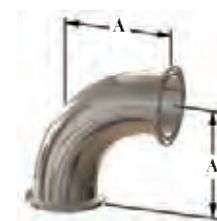

BPE Table DT-4.11.1-3

45° Weld Elbows - T2KS

Size	Dimension A	PL finish - SF1		PM finish - SF4	
		Part #	Price/E	Part #	Price/E
1/2"	2.250"	T2KS-050PL	\$41.60	T2KS-050PM	\$57.12
3/4"	2.250"	T2KS-075PL	37.50	T2KS-075PM	53.14
1"	2.250"	T2KS-100PL	34.03	T2KS-100PM	52.05
1 1/2"	2.500"	T2KS-150PL	39.75	T2KS-150PM	60.00
2"	3.000"	T2KS-200PL	50.78	T2KS-200PM	73.14
2 1/2"	3.375"	T2KS-250PL	75.06	T2KS-250PM	108.53
3"	3.625"	T2KS-300PL	103.01	T2KS-300PM	140.58
4"	4.500"	T2KS-400PL	186.03	T2KS-400PM	228.27

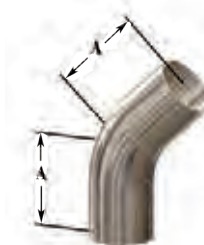

BPE Table DT-4.1.1-4

PL Finish – SF1
OD = 32R_a Mechanically Polished
ID = 20R_a Mechanically Polished

PM Finish – SF4
OD = 32R_a Mechanically Polished
ID = 15R_a Mechanically Polished and Electropolished

High Purity BioPharm Fittings

45° Clamp x Weld Elbows - T2KM

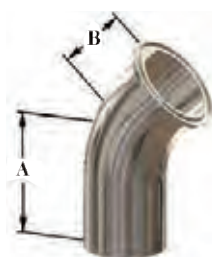

BPE Table DT-4.1.1-5

Size	Dimensions		PL finish - SF1		PM finish - SF4	
	A	B	Part #	Price/E	Part #	Price/E
½"	2.250"	1.000"	T2KM-050PL	\$57.95	T2KM-050PM	\$76.60
¾"	2.250"	1.000"	T2KM-075PL	57.12	T2KM-075PM	75.83
1"	2.250"	1.125"	T2KM-100PL	56.08	T2KM-100PM	78.27
1½"	2.500"	1.438"	T2KM-150PL	60.97	T2KM-150PM	85.45
2"	3.000"	1.750"	T2KM-200PL	79.55	T2KM-200PM	105.70
2½"	3.375"	2.063"	T2KM-250PL	110.12	T2KM-250PM	147.49
3"	3.625"	2.380"	T2KM-300PL	140.32	T2KM-300PM	181.48
4"	4.500"	3.125"	T2KM-400PL	221.73	T2KM-400PM	267.63

45° Clamp x Clamp Elbows - T2KMP



BPE Table DT-4.1.1-6

Size	Dimension A	PL finish - SF1		PM finish - SF4	
		Part #	Price/E	Part #	Price/E
½"	1.000"	T2KMP-050PL	\$61.80	T2KMP-050PM	\$80.38
¾"	1.000"	T2KMP-075PL	62.18	T2KMP-075PM	86.67
1"	1.125"	T2KMP-100PL	63.02	T2KMP-100PM	89.67
1½"	1.438"	T2KMP-150PL	66.93	T2KMP-150PM	95.96
2"	1.750"	T2KMP-200PL	91.80	T2KMP-200PM	122.56
2½"	2.063"	T2KMP-250PL	121.34	T2KMP-250PM	163.08
3"	2.380"	T2KMP-300PL	150.71	T2KMP-300PM	196.29
4"	3.125"	T2KMP-400PL	263.22	T2KMP-400PM	280.83

Weld x Weld x Weld Tees - T7WWW

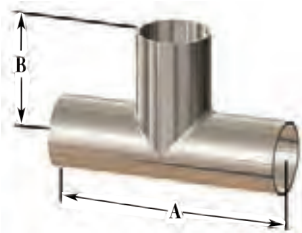

BPE Table DT-4.1.2-1

Size	Dimensions		PL finish - SF1		PM finish - SF4	
	A	B	Part #	Price/E	Part #	Price/E
½"	3.750"	1.875"	T7WWW-050PL	\$50.96	T7WWW-050PM	\$66.16
¾"	4.000"	2.000"	T7WWW-075PL	51.79	T7WWW-075PM	66.93
1"	4.250"	2.125"	T7WWW-100PL	44.48	T7WWW-100PM	62.18
1½"	4.750"	2.375"	T7WWW-150PL	54.50	T7WWW-150PM	74.35
2"	5.750"	2.875"	T7WWW-200PL	65.70	T7WWW-200PM	87.56
2½"	6.250"	3.125"	T7WWW-250PL	91.34	T7WWW-250PM	124.49
3"	6.750"	3.375"	T7WWW-300PL	113.40	T7WWW-300PM	150.57
4"	8.250"	4.125"	T7WWW-400PL	183.59	T7WWW-400PM	225.83

Weld x Weld x Weld Reducing Tees - T7RWWW



BPE Table DT-4.1.2-6

Size	Dimensions		PL finish - SF1		PM finish - SF4	
	A	B	Part #	Price/E	Part #	Price/E
¾" x ½"	4.000"	2.000"	T7RWWW-075050PL	\$77.89	T7RWWW-075050PM	\$99.49
1" x ½"	4.250"	2.125"	T7RWWW-100050PL	77.30	T7RWWW-100050PM	103.52
1" x ¾"	4.250"	2.125"	T7RWWW-100075PL	77.70	T7RWWW-100075PM	103.98
1½" x ½"	4.750"	2.375"	T7RWWW-150050PL	89.74	T7RWWW-150050PM	120.57
1½" x ¾"	4.750"	2.375"	T7RWWW-150075PL	78.14	T7RWWW-150075PM	109.30
1½" x 1"	4.750"	2.375"	T7RWWW-150100PL	68.34	T7RWWW-150100PM	99.82
2" x ½"	5.750"	2.625"	T7RWWW-200050PL	92.38	T7RWWW-200050PM	130.26
2" x ¾"	5.750"	2.625"	T7RWWW-200075PL	92.82	T7RWWW-200075PM	130.63
2" x 1"	5.750"	2.625"	T7RWWW-200100PL	79.55	T7RWWW-200100PM	117.76
2" x 1½"	5.750"	2.625"	T7RWWW-200150PL	80.96	T7RWWW-200150PM	119.17

PL Finish – SF1
 OD = 32R_a Mechanically Polished
 ID = 20R_a Mechanically Polished

PM Finish – SF4
 OD = 32R_a Mechanically Polished
 ID = 15R_a Mechanically Polished and Electropolished

High Purity BioPharm Fittings

3
621Pipe, Welding
& Tube Fittings

Weld x Weld x Clamp Short Outlet Tees - T7WWMS

Size	Dimensions		PL finish - SF1		PM finish - SF4	
	A	B	Part #	Price/E	Part #	Price/E
½"	3.750"	1.000"	T7WWMS-050PL	\$66.10	T7WWMS-050PM	\$85.58
¾"	4.000"	1.125"	T7WWMS-075PL	63.65	T7WWMS-075PM	83.20
1"	4.250"	1.125"	T7WWMS-100PL	61.80	T7WWMS-100PM	83.84
1½"	4.750"	1.375"	T7WWMS-150PL	69.36	T7WWMS-150PM	93.59
2"	5.750"	1.625"	T7WWMS-200PL	82.82	T7WWMS-200PM	108.91
2½"	6.250"	1.825"	T7WWMS-250PL	114.43	T7WWMS-250PM	151.67
3"	6.750"	2.125"	T7WWMS-300PL	197.42	T7WWMS-300PM	183.26
4"	8.250"	2.750"	T7WWMS-400PL	209.49	T7WWMS-400PM	255.76

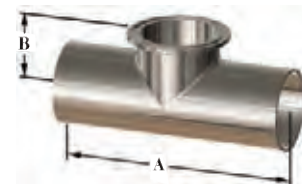

BPE Table DT-4.1.2-2

Weld x Weld x Clamp Tees - T7WWM

Size	Dimensions		PL finish - SF1		PM finish - SF4	
	A	B	Part #	Price/E	Part #	Price/E
½"	3.750"	2.250"	T7WWM-050PL	\$87.84	T7WWM-050PM	\$110.32
¾"	4.000"	2.375"	T7WWM-075PL	74.71	T7WWM-075PM	98.27
1"	4.250"	2.625"	T7WWM-100PL	73.22	T7WWM-100PM	110.73
1½"	4.750"	2.875"	T7WWM-150PL	83.12	T7WWM-150PM	128.23
2"	5.750"	3.375"	T7WWM-200PL	98.27	T7WWM-200PM	128.23
2½"	6.250"	3.625"	T7WWM-250PL	134.03	T7WWM-250PM	214.57
3"	6.750"	3.875"	T7WWM-300PL	167.06	T7WWM-300PM	301.54
4"	8.250"	4.750"	T7WWM-400PL	246.47	T7WWM-400PM	504.61

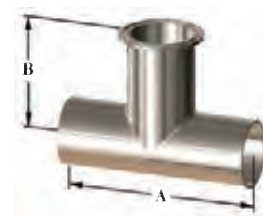

Clamp x Clamp x Clamp Tees - T7MP

Size	Dimensions		PL finish - SF1		PM finish - SF4	
	A	B	Part #	Price/E	Part #	Price/E
½"	4.500"	2.250"	T7MP-050PL	\$101.16	T7MP-050PM	\$124.49
¾"	4.750"	2.375"	T7MP-075PL	101.99	T7MP-075PM	125.26
1"	5.250"	2.625"	T7MP-100PL	111.35	T7MP-100PM	136.60
1½"	5.750"	2.875"	T7MP-150PL	118.90	T7MP-150PM	146.41
2"	6.750"	3.375"	T7MP-200PL	142.96	T7MP-200PM	172.25
2½"	7.250"	3.625"	T7MP-250PL	188.28	T7MP-250PM	227.94
3"	7.750"	3.875"	T7MP-300PL	241.28	T7MP-300PM	284.17
4"	9.500"	4.750"	T7MP-400PL	334.49	T7MP-400PM	381.79

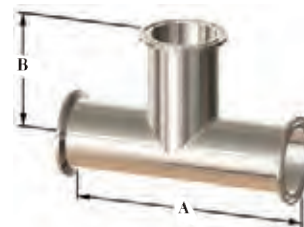

BPE Table DT-4.1.2-4

PL Finish – SF1
 OD = 32R_a Mechanically Polished
 ID = 20R_a Mechanically Polished

PM Finish – SF4
 OD = 32R_a Mechanically Polished
 ID = 15R_a Mechanically Polished and Electropolished

High Purity BioPharm Fittings

Weld x Weld Concentric Reducers - T31W



BPE Table DT-4.1.3-1(a)

Size	Dimension A	PL finish - SF1		PM finish - SF4	
		Part #	Price/E	Part #	Price/E
3/4" x 1/2"	4.00"	T31W-075050PL	\$67.77	T31W-075050PM	\$89.56
1" x 1/2"	4.50"	T31W-100050PL	92.62	T31W-100050PM	116.99
1" x 3/4"	4.00"	T31W-100075PL	54.68	T31W-100075PM	80.19
1 1/2" x 1/2"	5.50"	T31W-150050PL	97.11	T31W-150050PM	126.03
1 1/2" x 3/4"	5.00"	T31W-150075PL	71.16	T31W-150075PM	100.90
1 1/2" x 1"	5.00"	T31W-150100PL	58.33	T31W-150100PM	88.40
2" x 1/2"	7.75"	T31W-200050PL	131.73	T31W-200050PM	168.47
2" x 3/4"	7.25"	T31W-200075PL	117.49	T31W-200075PM	154.62
2" x 1"	7.25"	T31W-200100PL	95.26	T31W-200100PM	133.01
2" x 1 1/2"	5.25"	T31W-200150PL	70.39	T31W-200150PM	108.84

Clamp x Clamp Concentric Reducers - T3114MP

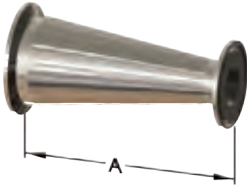

BPE Table DT-4.1.3-3(a)

Size	Dimension A	PL finish - SF1		PM finish - SF4	
		Part #	Price/E	Part #	Price/E
3/4" x 1/2"	2.000"	T3114MP075050PL	\$63.02	T3114MP075050PM	\$93.98
1" x 1/2"	2.500"	T3114MP100050PL	89.36	T3114MP100050PM	123.02
1" x 3/4"	2.000"	T3114MP100075PL	71.60	T3114MP100075PM	105.76
1 1/2" x 1/2"	3.500"	T3114MP150050PL	125.44	T3114MP150050PM	157.52
1 1/2" x 3/4"	3.000"	T3114MP150075PL	97.69	T3114MP150075PM	135.58
1 1/2" x 1"	3.000"	T3114MP150100PL	70.96	T3114MP150100PM	109.68
2" x 1/2"	5.500"	T3114MP200050PL	138.91	T3114MP200050PM	180.07
2" x 3/4"	5.000"	T3114MP200075PL	133.40	T3114MP200075PM	174.74
2" x 1"	5.000"	T3114MP200100PL	116.02	T3114MP200100PM	160.13
2" x 1 1/2"	3.000"	T3114MP200150PL	83.84	T3114MP200150PM	128.85

PL Finish – SF1
 OD = 32R_a Mechanically Polished
 ID = 20R_a Mechanically Polished

PM Finish – SF4
 OD = 32R_a Mechanically Polished
 ID = 15R_a Mechanically Polished and Electropolished

High Purity BioPharm Fittings

Weld x Weld Eccentric Reducers - T32W

3
621Pipe, Welding
& Tube Fittings

Size	Dimension A	PL finish - SF1		PM finish - SF4	
		Part #	Price/E	Part #	Price/E
¾" x ½"	4.00"	T32W-075050PL	\$92.62	T32W-075050PM	\$116.99
1" x ½"	4.50"	T32W-100050PL	100.96	T32W-100050PM	129.82
1" x ¾"	4.00"	T32W-100075PL	59.16	T32W-100075PM	89.23
1½" x ½"	5.50"	T32W-150050PL	124.23	T32W-150050PM	156.87
1½" x ¾"	5.00"	T32W-150075PL	79.37	T32W-150075PM	113.27
1½" x 1"	5.00"	T32W-150100PL	59.10	T32W-150100PM	90.90
2" x ½"	7.75"	T32W-200050PL	158.28	T32W-200050PM	196.60
2" x ¾"	7.25"	T32W-200075PL	149.94	T32W-200075PM	188.52
2" x 1"	7.25"	T32W-200100PL	114.23	T32W-200100PM	153.85
2" x 1½"	5.25"	T32W-200150PL	72.17	T32W-200150PM	113.07



BPE Table DT-4.1.3-1(a)

Clamp x Clamp Eccentric Reducers - T3214MP

Size	Dimension A	PL finish - SF1		PM finish - SF4	
		Part #	Price/E	Part #	Price/E
¾" x ½"	2.000"	T3214MP075050PL	\$67.68	T3214MP075050PM	\$101.99
1" x ½"	2.500"	T3214MP100050PL	99.93	T3214MP100050PM	137.76
1" x ¾"	2.000"	T3214MP100075PL	69.16	T3214MP100075PM	107.89
1½" x ½"	3.500"	T3214MP150050PL	115.25	T3214MP150050PM	157.11
1½" x ¾"	3.000"	T3214MP150075PL	94.23	T3214MP150075PM	136.73
1½" x 1"	3.000"	T3214MP150100PL	71.99	T3214MP150100PM	115.13
2" x ½"	5.500"	T3214MP200050PL	158.28	T3214MP200050PM	205.84
2" x ¾"	5.000"	T3214MP200075PL	149.67	T3214MP200075PM	197.57
2" x 1"	5.000"	T3214MP200100PL	119.74	T3214MP200100PM	168.47
2" x 1½"	3.000"	T3214MP200150PL	84.23	T3214MP200150PM	133.98



BPE Table DT-4.1.3-3(a)

PL Finish – SF1
 OD = 32R_a Mechanically Polished
 ID = 20R_a Mechanically Polished

PM Finish – SF4
 OD = 32R_a Mechanically Polished
 ID = 15R_a Mechanically Polished and Electropolished

High Purity BioPharm Fittings

Solid End Caps - T16AMP



BPE Table DT-4.1.5-2

Size	Dimensions		PL finish - SF1		PM finish - SF4	
	A	B	Part #	Price/E	Part #	Price/E
½" - ¾"	0.19"	1.00"	T16AMP-050075PL	\$12.22	T16AMP-050075PM	\$20.68
1" - 1½"	0.25"	1.99"	T16AMP-100150PL	14.07	T16AMP-100150PM	22.32
2"	0.25"	2.52"	T16AMP-200PL	17.70	T16AMP-200PM	32.61
2½"	0.25"	3.05"	T16AMP-250PL	24.25	T16AMP-250PM	42.91
3"	0.25"	3.58"	T16AMP-300PL	36.75	T16AMP-300PM	58.25
4"	0.31"	4.69"	T16AMP-400PL	94.77	T16AMP-400PM	112.78

Auto Weld Ferrules - TL14AM7



BPE Table DT-4.1.4-1

Size	Dimension A	PL finish - SF1		PM finish - SF4	
		Part #	Price/E	Part #	Price/E
½"	1.75"	TL14AM7-050PL	\$17.50	TL14AM7-050PM	\$31.97
¾"	1.75"	TL14AM7-075PL	18.47	TL14AM7-075PM	32.91
1"	1.75"	TL14AM7-100PL	24.50	TL14AM7-100PM	41.39
1½"	1.75"	TL14AM7-150PL	24.87	TL14AM7-150PM	43.01
2"	2.25"	TL14AM7-200PL	31.47	TL14AM7-200PM	52.10
2½"	2.25"	TL14AM7-250PL	38.27	TL14AM7-250PM	67.85
3"	2.25"	TL14AM7-300PL	47.17	TL14AM7-300PM	81.44
4"	2.25"	TL14AM7-400PL	80.45	TL14AM7-400PM	121.83

Weld Caps - T16W

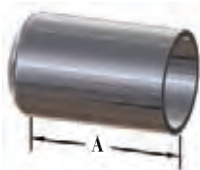

BPE Table DT-4.1.5-1

Size	Dimension A	PL finish - SF1		PM finish - SF4	
		Part #	Price/E	Part #	Price/E
½"	1.50"	T16W-050PL	\$20.78	T16W-050PM	\$58.79
¾"	1.50"	T16W-075PL	19.81	T16W-075PM	33.52
1"	1.50"	T16W-100PL	21.55	T16W-100PM	37.64
1½"	1.50"	T16W-150PL	27.18	T16W-150PM	45.39
2"	1.50"	T16W-200PL	31.28	T16W-200PM	51.79

PL Finish – SF1
 OD = 32R_a Mechanically Polished
 ID = 20R_a Mechanically Polished

PM Finish – SF4
 OD = 32R_a Mechanically Polished
 ID = 15R_a Mechanically Polished and Electropolished

Pressure - Temperature Ratings

- Ratings apply to all products covered by ANSI B16.5 valves conforming to the requirements of this standard must, in other respects, merit these ratings.
- All ratings are maximum allowable non-shock pressures (PSIG) at the tabulated temperatures (degree Fahrenheit). Temperatures are those on the inside of the pressure retaining structure.
- The use of these ratings requires gaskets conforming to the requirements of ANSI B16.5. The user is responsible for selecting gaskets of dimensions and materials to withstand the required bolt loading without injurious crushing, and suitable for the service conditions in all other respects.

Pressure Class	150	300
Test Pressure	425	1100
Service Temperature	Working Pressure	
-20°F to 100°F (-29°C to 38°C)	275	720
150°F (65°C)	255	710
200 (93°C)	240	700
250 (121°C)	225	690
300 (149°C)	210	680
350 (177°C)	195	675
400 (204°C)	180	665
450 (232°C)	165	650
500 (260°C)	150	625
550 (288°C)	140	590
600 (315°C)	130	555
650 (343°C)	120	515
700 (371°C)	110	470
750 (399°C)	100	425



Petroleum Fuel Nozzles K-2 to K-10

Ball.....	K-2
Gravity utility.....	K-3
Pressure.....	K-3
Overwing aircraft.....	K-4
Large capacity low pressure / gravity.....	K-4
Hose shank hose swivels.....	K-5
Heavy duty hose swivels.....	K-5
Mann Tek hose swivels.....	K-5
Dixon® diesel and gasoline nozzle accessories.....	K-6
Single plane hose swivels.....	K-6
Multi plane hose swivels.....	K-6
Breakaways.....	K-6
FuelMaster™ diesel.....	K-7
Big Mouth™ diesel.....	K-8
Farm and consumer.....	K-9
DEF automatic shutoff.....	K-10
High flow Fueeler 100™.....	K-10

Fire Nozzles K-11 to K-24

Industrial fog.....	K-11
Heavy duty industrial fog.....	K-11
High pressure industrial fog.....	K-11
Electrical fire all-fog.....	K-11
Domestic rack.....	K-12
Global rack.....	K-12
Polycarbonate fog nozzles.....	K-12
Factory Mutual approved fog.....	K-13
Polycarbonate electrical fire all-fog.....	K-13
Gaskets for fog.....	K-13
Constant flow fog.....	K-14
Blue refinery fog.....	K-14
Gaskets for constant flow and refinery fog.....	K-14
TriFlow fog.....	K-15
Garden hose.....	K-15
Heavy duty constant flow fog.....	K-16
Industrial pistol grip.....	K-16
Full flow industrial shut-off.....	K-16
Break apart attack.....	K-16
Ball shutoff - bolted style.....	K-17
Pistol grip adapters.....	K-17
Gallonage shut-off.....	K-18
Single.....	K-18
Dual.....	K-18

Fire Nozzles K-11 to K-24

Adjustable tri-flo selectable gallonage.....	K-18
Global forestry fog.....	K-18
Forestry fog.....	K-19
Forestry grade ball shut-off.....	K-19
Forestry grade ball shut-off with pistol grip.....	K-19
Tips for ball shut-off.....	K-19
Penetrator.....	K-20
Twin tip straight stream forestry.....	K-20
Ball shutoff.....	K-20
Polycarbonate ball shut-off.....	K-20
U.S. Coast Guard approved AFFF / water fog.....	K-21
U.S. Coast Guard approved fog.....	K-21
Brass ball shut-off.....	K-22
Nozzle tips.....	K-22
Plain hose.....	K-22
Omega™ monitor.....	K-23
Monitor.....	K-23
FirePro™ monitor.....	K-23
Master Stream.....	K-23
Red plain hose.....	K-24
UL play pipes with tip.....	K-24
Tips for UL play pipe.....	K-24

Washdown Nozzles K-25 to K-30

Swivel connectors for washdown spray guns.....	K-25
Ball type swivel x hose shank.....	K-25
Straight swivel x hose shank.....	K-25
Straight swivel x GHT thread.....	K-25
Hot water washdown spray.....	K-25
Mini spray.....	K-26
Spray.....	K-26
Washdown wand.....	K-26
Temperature indicating spray.....	K-27
Stainless steel industrial grade spray.....	K-27
Brass industrial grade front lever spray.....	K-27
Thermal-Gard™ elevated temperature spray.....	K-28
Spray valve and hose assembly.....	K-28
Industrial washdown.....	K-28
Sweeper.....	K-29
Water.....	K-29
Flexible.....	K-29
Brass / rubber power flow.....	K-29
Insulated.....	K-29
Pistol-grip.....	K-29
Twist.....	K-29
Adjust-A-Power.....	K-30
Constant flow nozzle displays.....	K-30
Constant flow nozzle with bumper.....	K-30



Washdown / Mixing Stations..... K-31

Water-steam washdown station	K-31
Hot and cold water mixing station.....	K-31
Rack for mixing station	K-31

Pressure Washing J32 to K-40

Spray guns	K-32
Anti-fatigue.....	K-32
Pressure.....	K-32
Heavy duty anti-fatigue	K-32
Pressure with extension.....	K-32
Pressure with hose, nozzle & lance	K-32
Spray lances and extensions for pressure gun	K-33
Spray lances	K-33
Dual spray lances	K-33
Molded grip extensions	K-33
Vented grip lances	K-33
Telescoping lance and belt for pressure gun	K-34
Swiveling quick couplings.....	K-34
Fixed plugs	K-35
Injector nozzles.....	K-35
Line strainer.....	K-35
High pressure spray soap nozzles	K-36
High pressure spray nozzles	K-36
Quick connect soap nozzle.....	K-36
Quick connect spray nozzle.....	K-36
Multi-pack quick connect nozzles	K-36
Multi-pack high pressure spray nozzles	K-36
Spray nozzle selection guidelines	K-37
Turbo nozzles	K-38
Nozzle holders.....	K-38
Inlet filter for turbo nozzles	K-38
Unloader valves.....	K-39
Thermal relief valve	K-39
Safety release valve	K-39
Balance release valve	K-40
Water broom.....	K-40



Ball Nozzles for Bulk Delivery

Features:

- rugged construction, high flow provides rapid fuel oil transfer/delivery
- heavy duty roller ball swivel with low temperature seals freely rotates without leaking at **-40°F (-40°C)** and **100 PSI**
- 3 PSI check valve is included to prevent back flow, 5 PSI is optional

nozzles

Female NPT Inlet	Outlet Type	Anodized Aluminum	
		Part #	Price/E
1¼"	swivel quick fill nut	BL062	\$729.25
1½"	swivel quick fill nut	BL064	729.25
1¼"	1¼" spout	BL066	729.25
1½"	1¼" spout	BL068	729.25
1½"	1½" spout	BL072	729.25
1¼"	1¼" female NPT	BL066NS	618.15
1½"	1¼" female NPT	BL068NS	619.20
1½"	1½" female NPT	BL072NS	618.15
2"	2" spout	BL920	840.05



BL062



BL072

replacement spouts

Size	Replacement For	Aluminum	
		Part #	Price/E
1¼"	BL066, BL068	1143A	\$55.50
1½"	BL072, BL919	1125A	60.40
2"	BL920	391137	84.45

repair kits

Repair Kits for Ball Nozzles (BL066, BL068, BL072, BL919)

Description	Part #	Price/E
inlet swivel seal and wear kit	SWMF-RK2	\$54.25
complete inlet swivel rebuild kit	SWMF-RK3	118.80
1½" FNPT replacement inlet swivel	SWMF-RK4	208.95
1¼" FNPT replacement inlet swivel	SWMF-RK5	208.95
1½" BSPP replacement inlet swivel	SWMF-RK6	208.95
replacement swivel outlet (BL062, BL064)	BL005	100.95
ball valve shaft seal kit	BL-RK4	48.90
complete ball nozzle seal kit	BL-RK10	47.65
optional check valve 5 PSI spring kit	BL-RK11	20.60
standard check valve 3 PSI cartridge kit	BL-RK12	77.00

Repair Kits for Super Ball Nozzle (BL920)

inlet swivel grease nipple kit (optional)	SWMF-RK1	\$16.25
inlet swivel seal and wear kit	SWMF-RK22	32.05
complete inlet swivel rebuild kit	SWMF-RK32	117.25
2" FNPT replacement inlet swivel	SWMF-RK42	240.25
1½" FNPT replacement inlet swivel	SWMF-RK52	240.25
complete ball nozzle seal kit	BL-RK102	35.45
optional check valve 5 PSI spring kit	BL-RK112	9.50
standard check valve 3 PSI cartridge kit	BL-RK122	45.50
replacement trigger kit	BL-RK13	70.00



BL072NS



BL920





Gravity Utility Nozzles

Application:

- for use with 12 volt pumps and gravity flow fittings in economy fuel dispensing applications

Features:

- manual operation (non-automatic)
- Underwriters Listed
- working pressure: **25 PSI**

Female NPT Inlet	Outlet Type	Die Cast Zinc Aluminum	
		Part #	Price/E
1"	1" female UNS	900 ¹	\$69.50
	1" straight spout	900S	78.45
	1" bent spout	900B	78.45
	¾" straight spout	900W34S	78.43
	¾" bent spout	900W34B	78.43
¾"	¾" straight spout	900S34 ²	81.75
	¾" bent spout	900B34 ²	81.75

¹ nozzle body only (no spout)

² ¾" nozzle inlet uses 1" x ¾" reducer bushing, supplied



900



900W34S



900B

replacement parts

Description	Part #	Price/E
¾" replacement straight spout	234-80-4	\$12.00
¾" replacement bent spout	234-80-5	18.20
1" replacement straight spout	875-4	12.25
1" replacement bent spout	875-5	13.00
trigger	900TK	5.05
plunger & valve assemblies, cap, O-ring	900SK	20.50

Pressure Nozzle for Bulk Delivery

Features:

- manual operation (non-automatic) for high pressures and fuel flow up to **100 GPM**
- easy opening dash pot design with shockless closing
- detachable trigger ratchet, packing gland and seal
- bronze trigger

Female NPT Inlet	Outlet Type	GPM @ 10 PSI	Aluminum	
			Part #	Price/E
1¼"	1¼" female NPT	80	114DNS	\$406.10
	1¼" spout	80	114D	451.45
1½"	1½" female NPT	100	112DNS	367.50
	1½" spout	100	112D	394.75



114DNS

replacement parts

Description	Part #	Price/E
aluminum replacement spout for 114D	1143A	\$55.50
aluminum replacement spout for 112D	1125A	60.40
main poppet, 2nd poppet, cap O-ring, valve stem	112DSK	99.50
blank plate to replace ratchet plate if ratchet not required	114DAL-AV-19	24.75
main and secondary poppets, cap O-ring, valve stem assembly and packing, sleeve stem packing and nut	114DSK	124.40



114D



Overwing Aircraft Nozzles

Features:

- manual operation (non-automatic) for high pressures and fuel flow up to **60 GPM at 20 PSI**
- easy opening dash pot design with shock-less closing
- detachable trigger ratchet, packing gland and seal
- bronze trigger and plastic guard pad to protect wing
- spout comes with cap, spring cord, fine mesh stainless steel screen filter and screw attachment for grounding cable (cable not supplied)



114D-AV-06ASM

Female NPT Inlet	Outlet Type	Aluminum	
		Part #	Price/E
1 1/4"	1" spout	114DAVR	\$766.65
	1 1/4" spout	114D-AV	766.65
1 1/2"	1 1/4" spout	114D-AV-06ASM	813.45

replacement parts

Description	Part #	Price/E
trigger, bushing, pin and cotter pin	114/2D-TK	\$38.05
main & secondary poppet assemblies, cap	114DAV-SK	133.55
O-ring, valve stem assembly	114DAL-AV-25	154.80
1" spout assembly	114DAL-AV-16	109.70

Large Capacity Low Pressure / Gravity Nozzle

Application:

- for low pressure/gravity applications

Features:

- rapid flow due to 1 1/4" oversize design
- maximum operating pressure: **25 PSI**



Female NPT Inlet	Outlet Type	Aluminum	
		Part #	Price/E
1 1/4"	1 1/4" spout	1250-94	\$259.30

repair kits

Description	Part #	Price/E
plunger, O-rings, valve seal, valve base, valve plate	1250SK	\$32.00



Hose Shank Hose Swivels

Application:

- for use with petroleum and home heating oil hose

Feature:

- prevents hose twisting or kinking

Male NPT	Shank Size	Part #	Price/E
1½"	1½"	1565U	\$153.20

repair kit

Description	Part #	Price/E
replacement seal kit and retaining ring	1500SK	\$20.10



Heavy Duty Hose Swivels

Features:

- male NPT x female NPT threaded connections
- heavy duty internal thrust bearing and anti-friction seal design ensures swiveling at **-40°F (-40°C)**
- can be lubricated without disassembly by using the optional grease nipple kit

Male NPT	Female NPT	Part #	Price/E
1¼"	1¼"	SWMF125	\$204.70
1½"	1½"	SWMF150	204.70
2"	2"	SWMF200	228.75

repair kits

Description	Part #	Price/E
inlet swivel grease nipple kit (optional)	SWMF-RK1	\$16.25
inlet swivel seal and wear kit	SWMF-RK22	32.05
complete inlet swivel rebuild kit	SWMF-RK32	117.25
2" FNPT replacement inlet swivel	SWMF-RK42	240.25
1½" FNPT replacement inlet swivel	SWMF-RK52	240.25



Mann Tek Hose Swivels

Features:

- allows the hose to relax to it's natural rest position while allowing freedom of movement without adding torque stress at the point of connection
- simple design, low maintenance - consists of 2 body halves, ball bearings and a washer
- male NPT x female NPT threaded connections
- FKM seals standard, Chemraz® and Kalrez® optional contact Dixon®
- working pressure: **150 PSI**
- maximum temperature: **300°F (149°C)**

Size	316 Stainless Steel		Aluminum	
	Part #	Price/E	Part #	Price/E
¾"	HS075SS	\$568.25	HS075AL	\$248.45
1"	HS100SS	568.25	HS100AL	248.45
1½"	HS150SS	593.95	HS150AL	271.30
2"	HS200SS	593.95	HS200AL	271.30
3"	HS300SS	1202.15	HS300AL	691.05
4"	HS400SS	2452.75	HS400AL	1182.15



Dixon® Diesel and Gasoline Nozzles Accessories

Single Plane Hose Swivels



Features:

- body: aluminum
- brass hex nut prevents galling in the nozzle
- seals: F-7036 Viton™
- nylon cord retainer

Size	Part #	Price/E
¾" x ¾"	DAWS34	\$51.30
1" x 1"	DAWS10	75.50

Multi-Plane Hose Swivels



Features:

- brass male end will not gall in nozzle castings
- dual O-rings seal with all fuels
- machined brass sleeve gives smooth seal surface - no leaks
- internal nylon retainer cord secures firmly but allows free rotation

Materials:

- body: machined aluminum casting; male end: machined brass bar stock; sleeve: machined brass bar stock

Size	Part #	Price/E
¾" male NPT x ¾" female NPT	DAC3434	\$77.45
1" male NPT x ¾" female NPT	DAC1034	77.45

Breakaways



Features:

- body: aluminum
- break rings (2): brass
- seals: F-7036 Viton™
- unique ball valves seal both ends when separated
- design provides consistent and reliable performance
- lightweight
- easy to repair
- ¾" Underwriter's Listed

Size	Separation Force (Lbs)	Part #	Price/E
¾"	325	DAB34	\$75.25
1"	325	DAB1	152.40

Applications:

- Provides breakaway protection for high capacity fueling operations such as truck and bus terminals, mining, off-road fueling and fuel oil delivery.

Features:

- body: nickel plated aluminum
- brass break rings: 4 in 1¼" and 1½"; 6 in the 2"
- seals: F-7036 Viton™
- check valve - PTFE ball seals both ends when separated

Size	Separation Force in Lbs.	Part #	Price/E
1¼"	600	DAB14	\$928.90
1½"	600	DAB15	928.90
2"	800	DAB2	1872.30



FuelMaster™ Diesel Nozzles

Application:

- truck stops and terminal operations (not designed for use with gravity flow tanks, small 12 volt or AC utility pumps, farm or consumer pumps) 

Features:

- high flow capacity
- Micro-touch valve provides smooth operation and exceptional flow control
- Roto-matic latch pin provides positive auto shut-off
- pure PTFE packing eliminates stem leaks
- super tough nylon hand guard
- easy to change 'locknut style' spout assembly
- green scuff guard

Optional Features:

- Underwriters Listed versions 
- UL listed for use with Gas 10% Ethanol blend and diesel
- super tough nylon trigger hold-open clip
- 'no pressure, no flow' (NPNF) safety valve prevents the trigger from being held open if pressure is not present

Materials:

- body and spout: aluminum
- body caps: zinc
- seals: FKM
- poppet disk: FKM
- stem packing: PTFE
- hand-guard and trigger hold open clip: super tough nylon
- trigger: steel
- snap-on cover: plastic
- scuff guard: vinyl

Features:

- with trigger hold-open clip
- non Underwriters Listed nozzle

NPT Inlet	Spout Outlet	Approximate Flow Rate at 20 PSI (GPM)	Part #	Price/E
1"	1-3/16"	35	<i>DFN100HF</i>	\$230.80
	1-3/16"	45	<i>DFN100SF</i>	316.90

Features:

- with trigger hold-open clip with 'no pressure, no flow' safety valve
- Underwriters Listed nozzle 

NPT Inlet	Spout Outlet	Approximate Flow Rate at 20 PSI (GPM)	Part #	Price/E
1"	1-3/16"	35	<i>DFN100HF-NPNF</i>	\$269.50
	1-3/16"	45	<i>DFN100SF-NPNF</i>	353.20

Features:

- without trigger hold-open clip
- Underwriters Listed nozzle 

NPT Inlet	Spout Outlet	Approximate Flow Rate at 20 PSI (GPM)	Part #	Price/E
1"	1-3/16"	35	<i>DFN100HF-NC</i>	\$230.80
	1-3/16"	45	<i>DFN100SF-NC</i>	316.90



DFN100HF



DFN100SF

Big Mouth™ Diesel Nozzles

Application:

- truck stops (not designed for use with gravity flow tanks, small 12 volt or AC utility pumps, farm or consumer pumps) 

Features:

- lightweight but strong
- Micro-touch valve provides smooth operation and exceptional flow control
- Roto-matic latch pin provides positive auto shut-off
- pure PTFE packing eliminates stem leaks
- super tough nylon hand guard
- snap-on handle cover makes changing scuff guards easy
- yellow scuff guard

Optional Features:

- Underwriters Listed versions 
- UL listed for use with Gas 10% Ethanol blend and diesel
- super tough nylon trigger hold-open clip
- 'no pressure, no flow' (NPNF) safety valve prevents the trigger from being held open if pressure is not present

Materials:

- body and spout: aluminum
- body caps: zinc
- seals: FKM / nitrile
- poppet disk: FKM
- stem packing: PTFE
- trigger: steel
- snap-on cover: plastic
- scuff guard: vinyl

Features:

- with trigger hold-open clip
- non Underwriters Listed nozzle

NPT Inlet	Spout Outlet	Approximate Flow Rate at 20 PSI (GPM)	Part #	Price/E
1"	1 1/8"	27	DFN100	\$179.00



DFN100

Features:

- with trigger hold-open clip
- with 'no pressure, no flow' safety valve
- Underwriters Listed nozzle 

NPT Inlet	Spout Outlet	Approximate Flow Rate at 20 PSI (GPM)	Part #	Price/E
1"	1 1/8"	27	DFN100-NPNF	\$217.70



DFN100-NC

Features:

- without trigger hold-open clip
- Underwriters Listed nozzle 

NPT Inlet	Spout Outlet	Approximate Flow Rate at 20 PSI (GPM)	Part #	Price/E
1"	1 1/8"	27	DFN100-NC	\$179.00

Farm and Consumer Nozzles

Application:

- small 12 volt or AC utility pumps, farm or consumer pumps (not designed for use with gravity flow tanks)



Features:

- Micro-touch valve provides smooth operation and exceptional flow control
- pure PTFE stem packing eliminates leaks
- heavy duty, strong, secure hook makes it easy to hang the nozzle on the pump
- Roto-matic latch pin provides positive auto shut-off
- Smartguard snap-on scuff guard

Optional Features:

- Underwriters Listed versions
- super tough nylon trigger hold-open clip
- 'no pressure, no flow' (NPNF) safety valve prevents the trigger from being held open if pressure is not present

Materials:

- body and spout: aluminum
- body caps: zinc or nylon
- seals: FKM
- poppet disk: FKM
- stem packing: PTFE
- hand-guard and trigger hold open clip: super tough nylon
- trigger: steel
- snap-on cover: plastic
- scuff guard: vinyl

Features:

- with trigger hold-open clip
- non Underwriters Listed nozzle

NPT Inlet	Spout Outlet	Approximate Flow Rate at 20 PSI (GPM)	Scuff Guard Color	Service	Part #	Price/E
3/4"	13/16"	18	black	gasoline	DN7UOBF	\$134.50
	15/16"	23	green	diesel	DN7LOBF	134.50
1"	1-1/8"	27	yellow	diesel	DFN100F¹	193.55

¹ Hand-guard and rear back clip: super tough nylon



1" diesel nozzle

Features:

- with trigger hold-open clip
- with 'no pressure, no flow' safety valve
- Underwriters Listed nozzle

NPT Inlet	Spout Outlet	Approximate Flow Rate at 20 PSI (GPM)	Scuff Guard Color	Service	Part #	Price/E
3/4"	13/16"	18	black	gasoline	DN7UOBF-NPNF	\$173.20
	15/16"	23	green	diesel	DN7LOBF-NPNF	173.20
1"	1-1/8"	27	yellow	diesel	DFN100F-NPNF	232.25



3/4" gasoline nozzle

Features:

- without trigger hold-open clip
- Underwriters Listed nozzle

NPT Inlet	Spout Outlet	Approximate Flow Rate at 20 PSI (GPM)	Scuff Guard Color	Service	Part #	Price/E
3/4"	13/16"	18	black	gasoline	DN7UOBF-NC	\$134.50
	15/16"	23	green	diesel	DN7LOBF-NC	134.50
1"	1-1/8"	27	yellow	diesel	DFN100F-NC	193.55



3/4" diesel nozzle

Fuel Nozzle Part Number Cross Reference

Dixon™	M. Carder	OPW	Emco	Husky	Catlow
DN7UOBF	N7UOBF	1AF-40FS	A2501F	XSF-33704	NENLF
DN7LOBF	N7LOBF	11APF-40FS	A2501LF	---	NELF



DEF Automatic Shutoff Nozzle

Application:

- designed for diesel exhaust fluid applications

Features:

- maximum operating pressure: **50 PSI**
- aluminum body double coated inside and out with PTFE baked on at **500°F (260°C)**
- spout: stainless steel
- wetted parts: stainless, acetal, PTFE
- seal material: FKM-A



BSPP Inlet	Spout Outlet	Approximate Flow Rate at 20 PSI (GPM)	Part #	Price/E
3/4"	13/16"	18	DEFN075	\$484.85

High Flow Fueler 100™ Nozzles

Application:

- for fueling trucks, buses, off-road equipment and fuel oil delivery

Features:

- *These nozzles are not to be used with gravity flow tanks.* 
- machined grooves in the spout are designed to hold nozzle more securely in the fill pipe
- high flow, heavy duty automatic nozzle



NPT Inlet	Spout Outlet	Approximate Flow Rate at 30 PSI (GPM)	Part #	Price/E
1 1/4"	1 3/8"	75	DNOG5-NL ¹	\$1044.45
1 1/2"	1 3/8"	75	DNOG5	766.80
1 1/2"	1 3/8"	75	DNOG6	766.80

¹ is a 1 1/4" nozzle without the locking handle



Industrial Fog Nozzles



Features:

- maximum operating pressure: **175 PSI** (water only) at **70°F (21°C)**
- delivers 30° - 60° - 90° fog pattern - shut-off - straight stream - fog
- UL listed and Factory Mutual approved for class A and B fires (except noted ¹)
- supplied with bumper

Size	Thread	90° Spray GPM @ 100 PSI	Brass	
			Part #	Price/E
3/4"	GHT	---	BFN75GHT ¹	\$186.30
3/4"	NPSH	---	BFN75	186.30
1"	NPSH	32	BFN100	221.80
1 1/2"	NPSH	85	BFN150	144.75
2"	NPSH	108	BFN200 ¹	334.35
1"	NST (NH)	32	BFN100NST	221.80
1 1/2"	NST (NH)	85	BFN150NST	144.75
2 1/2"	NST (NH)	205	BFN250NST ¹	309.00

- ¹ not UL Listed or Factory Mutual approved
- replacement washers can be found on page E-71



Heavy Duty Industrial Fog Nozzles



Features:

- maximum operating pressure: **175 PSI** (water only) at **70°F (21°C)**
- delivers 30° - 60° - 90° fog pattern - shut-off - straight stream - fog
- UL listed and Factory Mutual approved
- supplied with bumper

Size	Thread	90° Spray GPM @ 100 PSI	Brass	
			Part #	Price/E
1"	NPSH	---	HFN100	\$212.40
1 1/2"	NPSH	88 (+/-12)	HFN150	179.00
1"	NST (NH)	---	HFN100NST	212.40
1 1/2"	NST (NH)	88 (+/-12)	HFN150NST	179.00
1 1/2"	NYFD	---	HFN150NYFD	189.00

- replacement washers can be found on page E-71



High Pressure Industrial Fog Nozzles



Features:

- working pressure: **25 to 300 PSI** (water only) at **70°F (21°C)**
- combination straight stream and fog - shut-off - straight stream - fog
- Factory Mutual approved
- large one-piece rubber bumper with molded teeth
- knurled base

Size	Thread	90° Spray GPM @ 100 PSI	Brass	
			Part #	Price/E
1 1/2"	NPSH	117	HPFN150	\$224.40
	NST (NH)	117	HPFN150NST	224.40

- replacement washers can be found on page E-71



Electrical Fire All-Fog Nozzles



Features:

- maximum operating pressure: **100 PSI** (water only) at **70°F (21°C)**
- delivers 30° - 60° - 90° fog pattern - shutoff to 30° fog, adjustable to 90° fog
- UL listed and Factory Mutual approved for class C fires
- supplied with bumper
- Use of this nozzle is not likely to prove hazardous when nozzle is held in excess of 10 feet from electrical apparatus and circuits not involving more than 250,000 volts. ⚠

Size	Thread	90° Spray GPM @ 100 PSI	Brass	
			Part #	Price/E
1 1/2"	NST (NH)	90	BFNE150NST	\$234.30
	NPSH	90	BFNE150	234.30

- for fog nozzle flow rates please see next page
- replacement washers can be found on page E-71



Fog Nozzle Flow Rate Chart

Part Number	Inlet Pressure		Straight Stream		30°		60°		90°	
	PSI	kPa	GPM	LPM	GPM	LPM	GPM	LPM	GPM	LPM
BFN100	50	(345)	18	(68)	21	(79)	24	(91)	27	(102)
	75	(517)	22	(83)	25	(95)	28	(106)	32	(121)
	100	(690)	24	(91)	28	(106)	32	(121)	36	(136)
BFN150	50	(345)	45	(170)	50	(189)	55	(208)	60	(227)
	75	(517)	50	(189)	55	(208)	65	(246)	75	(284)
	100	(690)	55	(208)	60	(227)	75	(284)	85	(322)
BFN250	50	(345)	90	(341)	120	(454)	130	(492)	145	(549)
	75	(517)	100	(379)	140	(530)	150	(568)	180	(681)
	100	(690)	110	(416)	165	(625)	180	(681)	205	(776)
BRN150	50	(345)	45	(170)	50	(189)	55	(208)	60	(227)
	75	(517)	50	(189)	55	(208)	65	(246)	75	(284)
	100	(690)	55	(208)	60	(227)	75	(284)	93	(352)
BFNE150	100	(690)	n/a	n/a	---	---	---	---	91	(345)
HFN100	100	(690)	25	(95)	---	---	---	---	---	---
HFN150	100	(690)	---	---	---	---	---	---	86	(326)
HPFN150	275	(1040)	---	---	---	---	---	---	130	(492)

• fire fog nozzles are listed on the previous page



Domestic Rack Nozzles

Features:

- maximum operating pressure: **100 PSI** (water only) at **70°F (21°C)**
- UL listed and Factory Mutual approved for class A and B fires
- delivers 30° - 60° - 90° fog pattern - shut-off - straight stream - fog
- supplied without bumper

Size	Thread	90° Spray GPM @ 100 PSI	Brass	
			Part #	Price/E
1½"	NST (NH)	80	BRN150NST	\$152.60
	NPSH	80	BRN150	208.70

• replacement washers can be found on page E-71



Global Rack Nozzles

Features:

- maximum operating pressure: **100 PSI** (water only) at **70°F (21°C)**
- UL listed and Factory Mutual approved for class A and B fires
- delivers 30° - 60° - 90° fog pattern - shut-off - straight stream - fog
- supplied without bumper

Size	Thread	90° Spray GPM @ 100 PSI	Brass	
			Part #	Price/E
1½"	NST (NH)	80	BRN150NST-I	\$86.40
	NPSH	93	BRN150S-I	86.40

• replacement washers can be found on page E-71

Fog Nozzles

Features:

- shutoff - straight stream - fog
- maximum operating pressure: **100 PSI** (water only) at **70°F (21°C)**
- brass stem



with bumper



without bumper

Size	Thread	90° Spray GPM @ 100 PSI	Polycarbonate ¹		Polycarbonate ²	
			Part #	Price/E	Part #	Price/E
¾"	GHT	8.0	FNB75GHT ^{3,4}	\$40.80	---	---
¾"	NPS	30.9	FNB75S ⁴	40.80	---	---
1"	NPS	11.4	FNB100S ⁴	48.50	FN100S	\$48.35
1"	NPS	30.9	HGB100S	63.25	---	---
1½"	NPS	83.6	FNB150S	45.35	FN150S	41.50
1"	NST (NH)	11.4	FNB100NST	48.50	FN100NST	48.35
1"	NST (NH)	30.9	HGB100NST	63.25	---	---
1½"	NST (NH)	83.6	FNB150NST	45.35	FN150NST	41.50

¹ with bumper

² without bumper

³ standard flow

⁴ 120° spray GPM @100 PSI

• replacement washers can be found on page K-13



Factory Mutual Approved Fog Nozzles

Features:

- brass stem with locking nut
- shutoff-straight-stream-fog
- wings on sleeve for ease of adjustment
- maximum operating pressure: **100 PSI** (water only) at **70°F (21°C)**
- Factory Mutual approved

Size	Thread	90° Spray GPM @ 100 PSI	Polycarbonate ¹		Polycarbonate ²	
			Part #	Price/E	Global Part #	Price/E
¾"	GHT	30.9	SL075GHT³	\$49.15	---	---
¾"	NPSH	30.9	SL075³	48.20	---	---
1"	NPSH	30.9	SL100³	51.25	PFNB100S	\$21.65
1½"	NPSH	75.0	SL150	70.45	PFNB150S	27.00
1"	NST (NH)	30.9	SL100NST	51.25	---	---
1½"	NST (NH)	75.0	SL150NST	70.45	PFNB150NST	27.00

¹ with bumper

² without bumper

³ 120° spray on ¾" and 1"



with bumper



without bumper

Polycarbonate Electrical Fire All-Fog Nozzles

Features:

- opens and closes in a 30° fog pattern up to 120°- no straight stream
- maximum operating pressure: **100 PSI** (water only) at **70°F (21°C)**
- brass stem

Size	Thread	75° Spray GPM @ 100 PSI	Polycarbonate	
			Part #	Price/E
1½"	NPS	92	FNBE150S	\$46.10
	NST (NH)	92	FNBE150NST	46.10



Gaskets for Fog Nozzles

Size	Thread	ID	OD	Thickness	Buna-N	
					Part #	Price/E
1"	NPSH	0.937"	1.234"	0.125"	FNG100S	\$4.25
1"	NPSH	1.000"	1.375"	0.125"	HGG100S	4.55
1½"	NPSH	1.500"	1.827"	0.125"	FNG150S	3.25
1"	NST (NH)	0.937"	1.281"	0.125"	FNG100NST	4.25
1"	NST (NH)	1.000"	1.375"	0.125"	HGG100NST	4.55
1½"	NST (NH)	1.510"	1.906"	0.125"	FNG150NST	3.25

- dimensions are nominal



Constant Flow Fog Nozzles

Features:

- red polycarbonate with bumper and black plastic and steel stem
- provides consistent volume at any spray angle
- adjusts from straight stream to fog
- 1" and 1½" are ULC listed
- maximum operating pressure: **100 PSI** (water only) at **70°F (21°C)**



2½" nozzle with handles



2" nozzle without handles

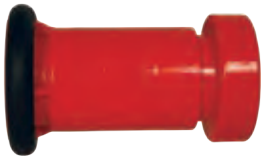

1½" nozzle

Size	Thread	90° Spray GPM @ 100 PSI	Polycarbonate	
			Part #	Price/E
¾"	GHT	8	CFB75GHT	\$30.00
1"	NPSH	22	CFB100S	32.70
1½"	NPSH	75	CFB150S ¹	28.05
1½"	NPSH	150	HGCFB150S ²	98.20
2"	NPSH	75	CFB2015S ¹	63.85
2"	NPSH	150	CFB200S ²	89.60
1"	NST (NH)	22	CFB100NST	32.70
1½"	NST (NH)	75	CFB150NST ¹	28.05
1½"	NST (NH)	150	HGCFB150NST ²	98.20
2½"	NST (NH)	150	CFB250NST ³	178.80
2½"	NST (NH)	215	HGCFB250NST ^{2,4}	229.10

- ¹ standard flow
- ² high flow
- ³ provided with handles

- gaskets located below
- NYF – New York Fire Dept. Thread 1½" (2.100 ODM X 8 TPI) — 2½" (3.030 ODM X 8 TPI)
- CF – Chicago Fire Dept. Thread 1½" (1.933 ODM X 11.5 TPI) — 2½" (2.990 ODM X 7.5 TPI)
- NYC – New York Corporation Thread 1½" (2.093 ODM X 11 TPI) — 2½" (3.000 ODM X 8 TPI)
- Also available CSA, BAT, NSS

Blue Refinery Fog Nozzles

Features:

- blue polycarbonate with bumper and black plastic and steel stem
- glass-filled
- provides consistent volume at any spray angle
- adjusts from Straight Stream to Fog
- resistant to petrochemicals
- maximum operating pressure: **100 PSI** (water only) at **70°F (21°C)**



Size	Thread	90° Spray GPM @ 100 PSI	Polycarbonate	
			Part #	Price/E
1½"	NPSH	75	RNB150S	\$34.50
	NST (NH)	75	RNB150NST	34.50

Gaskets

Application:

- used on constant flow and refinery fog nozzles



Size	Thread	ID	OD	Thickness	Buna-N	
					Part #	Price/E
1"	NPSH	0.900"	1.270"	0.125"	CFG100S	\$2.65
1½"	NPSH	1.510"	1.878"	0.125"	CFG150S	2.70
2"	NPSH	1.680"	2.340"	0.156"	CFG200S	2.80
1"	NST (NH)	0.900"	1.270"	0.125"	CFG100NST	2.65
1½"	NST (NH)	1.510"	1.906"	0.125"	CFG150NST	2.70
2½"	NST (NH)	2.250"	3.000"	0.187"	CFG250NST	2.95

- dimensions are nominal

TriFlow Fog Nozzles

Features:

- corrosion resistant plated aluminum
- combination 170° fog and straight stream
- Venturi flow improves straight stream and gallonage
- no nozzle teeth eliminates fingers and voids in the spray pattern thus producing a dense fog

Size	Thread	GPM @ 100 PSI Straight Stream		6061 T-6 Aluminum	
				Part #	Price/E
1½"	NST	60-100-140		TFN150NST-140	\$434.60
	NPSH	60-100-140		TFN150-140	434.60
1½"	NST	75-150-200		TFN150NST-200	434.60
	NPSH	75-150-200		TFN150-200	434.60



Garden Hose Nozzles

Features:

- offers two straight streams and one fog pattern ¹
- massive bumper specially formulated to resist damage and aging
- corrosion resistant hard coat

Size	Thread	GPM @ 40 PSI Straight Stream		6061-T6 Aluminum	
		1st	2nd	Part #	Price/E
¾"	GHT - without bumper	1-2	3-4	GHN75	\$186.20
	GHT - with bumper	1-2	3-4	GHN75-B	233.25

¹ fog pattern is **4-5 GPM @ 40 PSI**



GHN75



GHN75-B

Econo Fog Nozzles

Features:

- rugged, lightweight, corrosion resistant
- supplied without bumper
- for cabinet use, discourages theft
- for use up to 100 PSI (water only)

Size	Thread	Straight Stream @ 100 PSI	6061-T6 Aluminum	
			Part #	Price/E
1"	NPSH	56	AFN100	\$223.25
1"	NST	56	AFN100NST	223.25
1½"	NPSH	56	AFN150	283.35
1½"	NST	56	AFN150NST	283.35



Heavy Duty Constant Flow Fog Nozzles



Size	Thread	Length	GPM @ 100 PSI	Fiberglass Reinforced Composite	
				Part #	Price/E
1½"	NPSH	5"	95	CFFR150	\$117.00
	NST (NH)	5"	95	CFFR150NST	117.00

Full Flow Industrial Shut-Off / Nozzles



Features:

- metal bail and handle (no plastic)
- full 1½" waterway
- rubber pistol grip
- maximum operating pressure: **200 PSI** (water only) at **70°F (21°C)**

Note: product will be discontinued as stock is depleted

Size	Description	NPSH Aluminum		NST Aluminum	
		Part #	Price/E	Part #	Price/E
1½"	shut-off only	FFBSO150	\$334.55	FFBSO150NST	\$334.55
1½"	shut-off with integral fog nozzle	FFBSO150	480.00	FFBSO150NST	480.00

Break Apart Attack Nozzles



Application:

- low-cost, versatile, and easy-to-use nozzle for first responders in rural and suburban fire departments

Features:

- minimal training required to connect and operate the nozzle
- nozzle uses a 1½" coupler, provides **20-90 GPM** fog or straight stream flows at **100 PSI**
- nozzle can be separated from the shut off valve for extended hose lays and other uses
- meets or exceeds USDA Forestry Service standards

Size	Thread	Aluminum	
		Part #	Price/E
1"	NPSH	ABN100S	\$807.85
	NST (NH)	ABN100F	807.85
1½"	NPSH	ABN150S	897.85
	NST (NH)	ABN150F	897.85



Ball Shut-Off Nozzles - Bolted Style

Features:

- rugged and lightweight
- pistol grip
- hardcoated female swivel inlet and male outlet
- maximum operating pressure: **200 PSI** (water only) at **70°F (21°C)**



Size	Thread	Waterway	Cast Aluminum	
			Part #	Price/E
1½"	NST (NH)	1⅜"	ACPSO150F	\$170.00
	NPSH	1⅜"	ACPSO150	273.45

Pistol Grip Adapters

Features:

- converts any standard fog nozzle to a well-balanced, easy to hold pistol grip fog nozzle making the job of holding high pressure lines easier
- full-time ball bearing swivel base
- corrosion resistant
- hardcoated per MIL-A-8625-F TYPE 111, (Polylube 1)



Size	Thread	6061 T-6 Aluminum	
		Part #	Price/E
1"	NST	PGA100NST	\$463.95
1½"	NST	PGA150NST	463.95
	NPSH	PGA150NPSH	463.95
2½"	NST	PGA250NST	601.40



Single Gallonage Shut-off Nozzles



Features:

- PTFE hard-coated for greater corrosion resistance and durability
- lightweight and easily maneuvered
- full-time ball bearing swivel base
- metal ball with non-stick Delrin® seats
- 1-1/16" waterway

Size	Thread	Constant GPM @ 100 PSI	Aluminum	
			Part #	Price/E
1"	NST	95	BVSO100NST	\$1648.00
	NPSH	95	BVSO100	1648.00
1½"	NST	95	BVSO150NST	1648.00
	NPSH	95	BVSO150	1648.00
	NST	125	BVSO150NST-125	1648.00
	NPSH	125	BVSO150-125	1648.00

Dual Gallonage Shut-off Nozzles



Features:

- PTFE hard-coated for greater corrosion resistance and durability
- lightweight and easily maneuvered
- full-time ball bearing swivel base
- metal ball with non-stick Delrin® seats
- 1-1/16" waterway

Size	Thread	Constant GPM @ 100 PSI	Aluminum	
			Part #	Price/E
1"	NST	25 - 70	BVDSO100NST	\$1648.00
	NPSH	25 - 70	BVDSO100	1648.00
1½"	NST	25 - 70	BVDSO150NST	1648.00
	NPSH	25 - 70	BVDSO150	1648.00

Adjustable Tri-Flo Selectable Gallonage Nozzles



Features:

- corrosion resistant plated with Neoprene bumper
- full-time ball bearing swivel base
- dense fog delivery with no voids or fingers in pattern
- metal ball with non-stick Delrin® seats

Size	Thread	Constant GPM @ 100 PSI	Aluminum	
			Part #	Price/E
1½"	NST	60 - 100 - 140	BVTSO150NST	\$1648.00
	NPSH	60 - 100 - 140	BVTSO150	1648.00
	NST	75 - 150 - 200	BVTSO150NST-200	1846.00
	NPSH	75 - 150 - 200	BVTSO150-200	1846.00
2½"	NST	100 - 200 - 300	BVTSO250NST	1882.25

Global Forestry Fog Nozzles



Size	Thread	GPM @ 100 PSI Straight Stream		Anodized Aluminum	
		1st	2nd	Part #	Price/E
1½"	NPSH	23.8	73.9	GFN150	\$84.85
	NST (NH)	37.6	95.0	GFN150NST	84.85

Forestry Fog Nozzles

Features:

- maroon hard-coated barrel allows for easy identification
- corrosion resistant plated
- dual flow rate nozzles offer two straight stream and two fog patterns
- combination fog and straight stream
- maximum operating pressure: **600 PSI** (water only) at **70°F (21°C)**

Size	Thread	GPM @ 100 PSI Straight Stream		6061-T6 Aluminum	
		1st	2nd	Part #	Price/E
¾"	GHT	1-2	3-4 ¹	FFN75GHT¹	\$209.10
1"	NPSH	12	25	FFN100^{2,4}	219.65
1½"	NPSH	25	70	FFN150	294.60
1"	NST (NH)	12	25	FFN100NST	219.65
1½"	NST (NH)	25	70	FFN150NST^{3,4}	294.60



FFN75GHT



FFN100

¹ GPM @ 40 PSI

² FFN100 meets USFS 5100-239A and NSN 4210-01-165-6603

³ FFN150NST meets USFS 5100-107A and NSN 4210-01-167-1123

⁴ both nozzles conform to Forestry Service specification 5100-239C and 5100-107a

Forestry Grade Ball Shut-Off Nozzles

Features:

- NFPA1964 compliant
- hardcoated threads, acetal ball and rigid inlet
- maximum operating pressure: **600 PSI** at ambient temperature **70°F (21°C)**
- FSS specification 5100-238

Size	Thread	Waterway	Anodized Aluminum	
			Part #	Price/E
1"	NPSH	¾"	FBSO100S	\$384.00
1½"	NPSH	1"	FBSO150S	350.00
1"	NST (NH)	¾"	FBSO100F	384.00
1½"	NST (NH)	1"	FBSO150F	350.00



Forestry Grade Ball Shut-Off Nozzles with Pistol Grip

Features:

- NFPA1964 compliant
- hardcoated threads, acetal ball and full time live swivel inlet
- maximum operating pressure: **600 PSI** at ambient temperature **70°F (21°C)**
- FSS specification 5100-238

Size	Thread	Waterway	Anodized Aluminum	
			Part #	Price/E
1"	NPSH	¾"	FBSO100S-PG	\$520.70
1½"	NPSH	1"	FBSO150S-PG	596.50
1"	NST (NH)	¾"	FBSO100F-PG	520.70
1½"	NST (NH)	1"	FBSO150F-PG	596.50



Tips for Ball Shut-Off Nozzles

Features:

- lightweight
- maximum operating pressure: **200 PSI** (water only) at ambient temperature **70°F (21°C)**
- ½" orifice standard, other sizes available, contact Dixon®

Size	Thread	Length	Orifice	Anodized Aluminum	
				Part #	Price/E
1"	NPSH	4"	½"	ANT100	\$261.60
1½"	NPSH	4¾"	½"	ANT150	238.55
1"	NST (NH)	4"	½"	ANT100F	261.60
1½"	NST (NH)	4¾"	½"	ANT150F	238.55



NPSH



NST

- Gaskets are special order, please call 877.712.6179 for assistance.

Penetrator Nozzles



Features:

- designed with standard 1½" NPSH male hose threads that are converted to female thread for connection to the hose using a double female rigid connector
- ¼" discharge orifice generates a high velocity water jet that is effective against deep seated wildland fires
- maximum operating pressure: **200 PSI** (water only) at ambient temperature **70°F (21°C)**

Size	Thread	Length	Orifice	Polycarbonate	
				Part #	Price/E
1½"	NPSH	5½"	¼"	PFN4005S	\$51.55
	NST (NH)	5½"	¼"	PFN4005F	51.55

Twin Tip Straight Stream Forestry Nozzles



Features:

- molded high strength red polycarbonate
- solid, one-piece reversible twin tip has ¼" and ⅜" orifices
- maximum operating pressure: **100 PSI** (water only) at ambient temperature **70°F (21°C)**

Size	Thread	Length with tip	Length without tip	Orifice of base nozzle	Polycarbonate	
					Part #	Price/E
1½"	NPSH	9"	7½"	½"	PTTF150S	\$32.10
	NST (NH)	9"	7½"	½"	PTTF150F	32.10

Ball Shut-Off with Nozzle



FNPSO150F-30

FNPSO150S-30

Features:

- flexible design allows nozzle tip to be detached so a mating foam inductor can be inserted between the tip and shut-off valve
- lightweight
- black pistol grip shutoff with nozzle
- maximum operating pressure: **150 PSI** (water / AFFF only) at **70°F (21°C)**

Size	Body Color	Thread	GPM	Polycarbonate	
				Part #	Price/E
1½"	red	NPSH	30	FNPSO150S-30	\$403.10
	orange	NST (NH)	30	FNPSO150F-30	403.10
1½"	red	NPSH	70	FNPSO150S-70	403.10
	orange	NST (NH)	70	FNPSO150F-70	403.10

Ball Shut-Off



Features:

- lightweight
- maximum operating pressure: **150 PSI** (water or AFFF only) at ambient temperature **70°F (21°C)**

Size	Thread	Polycarbonate	
		Part #	Price/E
1½"	NPSH	PPSO150S	\$412.40
	NST (NH)	PPSO150F	412.40

U.S. Coast Guard Approved AFFF / Water Fog Nozzles

Application:

- designed for maximum efficiency with AFFF (Aqueous Film Forming Foams) or water on shipboard, offshore rigs and industrial applications

Features:

- corrosion resistant brass construction
- rubber-like bumper and handle for added protection
- Zytel (nylon) horseshoe handle
- double row of molded teeth for excellent fog pattern
- flush without shutting down
- constant gallonage in all fog and straight stream patterns
- combination fog and straight stream
- maximum operating pressure: **100 PSI** (water/AFFF only) at **70°F (21°C)**



CGSN150F



CGSN151F

Thread NST (NH)	Description	Fog Flow GPM @100 PSI	Approval #	Brass	
				Part #	Price/E
1½"	nozzle	95	162.027/13/0	CGSN150F	\$1789.20
	nozzle w/pistol grip	95	162.027/14/0	CGSN151F	1962.45

- Gaskets are special order, please call 877.712.6179 for assistance.

Thread NPSH	Description	Fog Flow GPM @100 PSI	Brass	
			Part #	Price/E
1½"	nozzle	95	CGSN150S	\$1789.20
	nozzle w/pistol grip	95	CGSN151S	1962.45

U.S. Coast Guard Approved Fog Nozzles

Application:

- designed to US Coast Guard specifications for fighting fires with drafted water, required equipment for all commercial vessels under US registry

Features:

- maximum operating pressure: **100 PSI** (water/AFFF only) at **70°F (21°C)**
- corrosion resistant brass construction
- combination fog and straight stream for shipboard fire fighting
- applicator tips are available, consult Dixon® for pricing and availability



Thread	Fog Flow GPM @100 PSI	Cast Brass	
		Part #	Price/E
1½" NST	55	CGN150NST	\$1854.30
2½" NST	108	CGN250NST	2190.30

- Gaskets and tips are special order, please call 877.712.6179 for assistance.



Fire Nozzles

Ball Shut-Offs



Features:

- full time swivel base ensures durable rubber-like handle can be positioned for easy operation
- maximum operating pressure: **100 PSI** (water only) at **70°F (21°C)**

Thread	Length	Waterway	Cast Brass	
			Part #	Price/E
1½" NST (NH)	4¾"	1⅜"	BSO150NST	\$1363.75
1½" NPSH	4¾"	1⅜"	BSO150S	1363.75

Replacement Part



Description	Composite	
	Part #	Price/E
replacement handle	BSO150-H	\$81.95

Nozzle Tips



Features:

- straight stream only
- maximum operating pressure: **100 PSI** (water only) at **70°F (21°C)**
- **74 GPM @ 100 PSI**

Thread	Length	Orifice	Satin Brass	
			Part #	Price/E
1" NST (NH)	4¾"	½"	BNT100F	\$154.15
1" NPSH	4¾"	½"	BNT100S	154.15
1½" NST (NH)	4⅜"	½"	BNT150F	181.15
1½" NPSH	4⅜"	½"	BNT150S	222.25

Plain Hose Nozzles

Features:

- finish: satin
- maximum operating pressure: **100 PSI** (water only) at **70°F (21°C)**



Size	Thread	Overall Length	Orifice	Replacement Gasket	Previous Part #	Brass	
						Part #	Price/E
¾"	GHT	6"	1/4"	KRW5	500SN6	BN6	\$41.75
¾"	NPSH	6"	1/4"	KRW5	---	BN7	41.75
1"	NPSH	8"	5/16"	KRW10	---	BN10	48.40
1¼"	NPSH	10"	3/8"	KRW15	---	BN12	73.00
1½"	NPSH	10"	1/2"	KRW20	---	BN15	59.40
2"	NPSH	12"	9/16"	SW200	---	BN20	106.40
2½"	NPSH	12"	1"	KRW35	---	BN25	153.10
1"	NST (NH)	8"	5/16"	SW100F	---	BN10F	48.40
1½"	NST (NH)	10"	1/2"	SW150	---	BN15F	59.40
2½"	NST (NH)	12"	1"	SW250	---	BN25F	153.10
1½"	NYFD	10"	1/2"	SW150	---	BN15NYFD	60.00
2½"	NYFD	12"	1"	SW250	---	BN25NYFD	175.00

Omega™ Monitor



Features:

- cast-in turning vanes for a more efficient flow
- 360° horizontal and 150° vertical travel
- friction loss: **10 PSI at 800 GPM** (.7 bar at 3030 LPM)
- 4 bolt hole pattern on flange
- Factory Mutual approved



Size	Inlet	Outlet	Waterway	Flow	Brass	
					Part #	Price/E
17" x 11½"	3" flange	2½" MNST	3"	1250 GPM	AK3526-300FL	\$7073.15

- For flange dimensions, diagrams and additional information please reference dixonvalve.com.

Monitor Nozzle

Features:

- fixed teeth
- combination Straight, Stream and Fog - no shutoff
- fixed gallonage master stream nozzle
- factory set at **500 GPM** (1900 lpm) field changeable to **300** or **700 GPM** (1140 or 2660 LPM)
- maximum operating pressure: **100 PSI** (water only)



Size	Thread	90° Spray GPM @ 100 PSI	Brass	
			Part #	Price/E
2½"	NST (NH)	500	AK4450NST	\$2428.95

- Gaskets are special order, please call 877.712.6179 for assistance.

FirePro™ Monitor



Features:

- seamless 2½" monitor - rated at 750 GPM
- carbon steel construction, stainless steel discharge tip and ball bearings
- 360° horizontal and 140° vertical travel
- red epoxy finish standard
- 150# ASA raised face 4" flange
- Factory Mutual approved



Size	Inlet	Outlet	Waterway	Flow GPM	Carbon Steel	
					Part #	Price/E
22" x 13"	4" flange	2½" MNST	2½"	750	FP475S	\$3780.00

- Gaskets are special order, please call 877.712.6179 for assistance.
- For flange dimensions, diagrams and additional information please reference dixonvalve.com.

Master Stream Nozzles

Features:

- factory set at **500 GPM**
- featuring a straight stream to fog 'quick throw' pattern change
- constant gallonage

Size	Thread	Material	Part #	Price/E
2½"	NST (NH)	brass	FP500B ¹	\$2749.10
	NST (NH)	aluminum	FP500A	2285.20



¹ Factory Mutual approved

- Gaskets are special order, please call 877.712.6179 for assistance.

Red Plain Hose Nozzles



Feature:

- maximum operating pressure: **100 PSI** (water only) at **70°F (21°C)**

Size	Thread	Length	Orifice	Polycarbonate	
				Part #	Price/E
1½"	NPSH	10"	½"	PN15	\$18.00
	NST (NH)	10"	½"	PN15F	18.00



UL Play Pipes with Tip

Application:

- often required in hydrant houses by Insurance Underwriters

Features:

- swivel handle, red marlin trim
- maximum operating pressure: **100 PSI** (water only) at **70°F (21°C)**
- UL listed and Factory Mutual approved
- ULT male thread specification: 2-3/16" ODM x 12 TPI
- comes standard with 1½" orifice tip



Size	Female Thread	Male Thread	Overall Length	Brass	
				Part #	Price/E
2½"	NST (NH)	ULT	30"	UPP250F	\$718.35
				UPP250F-SPEC	585.35

playpipe only

Tips for UL Play Pipe

Features:

- finish: satin
- maximum operating pressure: **100 PSI** (water only) at **70°F (21°C)**
- ULT male thread specification: 2-3/16" ODM x 12 TPI



Orifice	Part #	Cast Brass	
		Price/E	
1½"	UPPT	\$133.00	
1¼"	UPPT125	175.00	
1½"	UPPT150	175.00	
1¼"	UPPT175	175.00	

Street Cleaning Nozzles

Feature:

- welded fabrication



Size	Connection	Aluminum	
		Part #	Price/E
2"	female cam	200DBAL	\$264.05
3"	female cam	300DBAL	276.10

Swivel Connectors for Washdown Spray Guns

Ball Type Swivel x Hose Shank

Features:

- swivel connector for stainless spray nozzles
- 360° ball type swivel adapter helps prevent hose kinking

NPT	Hose ID	300 Stainless Steel	
		Part #	Price/E
1/2"	1/2"	SSA44	\$225.00
	5/8"	SSA54	225.00
	3/4"	SSA64	225.00



Straight Swivel x Hose Shank

Features:

- swivel body
- EPDM gasket

NPT	Hose ID	Brass		Stainless Steel	
		Part #	Price/E	Part #	Price/E
1/2"	1/2"	BNS44	\$61.90	BNS44SS	\$85.40
	3/4"	BNS64	61.90	BNS64SS	116.00



Straight Swivel x GHT Thread

NPT	Female GHT	Brass	
		Part #	Price/E
1/2"	3/4"	BMAS974	\$61.90



Hot Water Washdown Spray Nozzles

Applications:

- for low pressure cleaning, tank and drum cleaning and chemical manufacturing

Features:

- designed for operator comfort
- variable spray pattern from conical spray to solid stream
- hose connects at base of gun for easy maneuvering
- 1/2" female NPT inlet
- rubber coated handle protects hands from water temperatures to 150°F (66°C)
- **12.5 GPM** flow capacity at **150 PSI**
- *Do not use with steam lines.* 



Cover Color	Brass		Aluminum	
	Part #	Price/E	Part #	Price/E
black	BWSG	\$269.40	AWSG	\$288.75
white	BWSG-W	295.95	AWSG-W	309.05



Washdown Nozzles

Mini Spray Nozzle



Features:

- ½" female NPT inlet 
- not for use with steam
- designed as an industrial lightweight nozzle with heavyweight performance
- durable dark blue cover protects user from hot surfaces produced by high temperature wash down applications
- reduces hand fatigue and provides smooth lever action
- variable spray patterns from fan spray to solid stream
- drip-free automatic shutoff feature
- pressure rating **150 PSI at 200°F (93°C)**
- flow: **9.6 GPM at 100 PSIG**

Stainless Steel		Price/E
Part #		
DM150SDB		\$223.40

Spray Nozzle



Features:

- ½" female NPT inlet
- designed to prevent accidental spray
- durable dark blue cover prevents front-mounted lever from being accidentally activated if nozzle is dropped
- reduces hand fatigue and provides smooth lever action
- trigger locking mechanism provides safe and secure method of keeping the nozzle open during any spray pattern
- variable spray patterns from fan spray to solid stream
- drip-free automatic shut-off feature
- can be used with **D150S-WAND**
- rated to **150 PSI at 200°F (93°C)**
- **9.6 GPM** flow capacity at **100 PSIG**

Stainless Steel		Price/E
Part #		
D150SDB		\$423.85

Washdown Wand



Features:

- designed to provide user with a means of reaching desired washdown locations previously deemed unreachable by extending the nozzle by 3'
- adjustable spray tip can be changed from fan to solid spray by twisting the tip until the desired flow pattern is achieved
- quick disconnect feature allows user to quickly connect wand to the nozzles above
- designed to only fit the D150DSB nozzle
- minimum pressure is **75 PSI**
- wand is not for use with steam 

300 Series Stainless Steel		Price/E
Part #		
D150S-WAND		\$456.00

Temperature Indicating Spray Nozzle

Features:

- easy to read dial thermometer at rear of the nozzle provides accurate and continual monitoring of water temperature
- plastic sight window
- gauge assembly is recessed into the rubber cover for complete protection
- alerts the operator to shut-down the steam valve upon cold water failure, preventing scalding and steam burn injuries ensuring operator safety
- ensures a more accurate discharge water temperature reading
- recommended for water temperatures to **200°F (93°C)**
- maximum operating pressure: **150 PSI**
- **12.5 GPM** flow capacity
- ½" female NPT inlet
- black cover



Part #	Bronze	Price/E
BWSG-TI		\$427.75

Stainless Steel Industrial Grade Spray Nozzle

Application:

- recommended for use in corrosive applications where bronze and aluminum nozzles are not suitable

Features:

- heavy duty 300 series stainless steel body and barrel
- variable spray pattern adjusts from a soft spray to a solid stream
- Replaceable rubber cover is specially formulated to resist a wide range of oils and chemicals and protect surrounding equipment.
- maximum operating pressure: **150 PSI**
- maximum flow: **12.5 GPM** at **150 PSI**
- ½" female NPT inlet
- maximum temperature: **200°F (93°C)**



Part #	300 Stainless Steel	Price/E
300SSSG		\$661.30

Brass Industrial Grade Front Lever Spray Nozzle

Features:

- provides effortless one hand operation; by actuating the operating lever the valve is opened/closed and the jet power is regulated from spray to concentrated jet
- adjusting screw on back of gun allows you to fix the desired form of jet, fixing clamp for the operating lever allows lockable position for service
- maximum operating pressure: **350 PSI**
- suitable for hot water up to **122°F (50°C)**
- flow: **6.6 GPM** at **72 PSI**
- ½" female NPT inlet
- durable blue rubber cover



Part #	Brass	Price/E
DWG050		\$195.00

Thermal-Gard™ Elevated Temperature Spray Nozzle



Features:

- Thermal-Gard™ elevated temperature spray nozzle protects the operator from extreme hot water temperatures that exceed the comfort zone of standard hot water nozzles.
- Assembly includes required special rigid, stainless steel adapter, (3/8" male NPT x 1/2" female NPT).
- Thermal insulating sleeve reduces overall heat during elevated temperature conditions.
- Stainless steel lever handle is coated for additional thermal protection and operator comfort.
- Lightweight aluminum alloy body reduces overall weight
- Aluminum alloy body is electroless nickel plated for additional corrosion protection
- Recommended for water temperatures above **140°F (60°C)** to a maximum temperature of **200°F (93°C)**
- **12.5 GPM** flow capacity
- working pressure: **150 PSI**
- 3/8" female NPT inlet
- black cover

Part #	Aluminum	Price/E
AWSG-TG		\$355.80

Spray Valve and Hose Assembly

Spray Valves

Features:

- even spray valve mist provides proper moisture on paper roll ends
- helps eliminate wrinkles and folder delivery problems, increasing pressroom production and reducing waste
- a slight flex of the hose in any direction (360°) activates the spray
- quick action with no protruding levers, thumb depressors, triggers or other devices utilized
- positive water seal when hose is released causes the internal valve to close and immediately shut off spray
- sealed mechanism with no packing gland



83304



83306H

Female NPT Size	Description	Part #	Price/E
1/4"	valve only	83304	\$54.35
3/8"	valve only	83306	55.40
1/4"	valve with hook	83304H	56.84
3/8"	valve with hook	83306H	57.75

Spray Valve Hose Assembly

Features:

- 3/8" ID
- 5' hose



Male NPT Inlet	Part #	Price/E
3/8"	8320605	\$88.24

- Additional hose lengths are available - contact Dixon®

Industrial Washdown Nozzles

Features:

- maximum operating pressure: **100 PSI** (*water only*) at **70°F (21°C)**
- delivers 30° - 60° - 90° fog pattern
- shut off - straight stream - fog
- supplied with bumper



Size	Thread	90° Spray GPM @ 100 PSI	Brass	
			Part #	Price/E
1 1/2"	NPSH	88 (+/-12)	WDN150	\$74.25
	NST (NH)	88 (+/-12)	WDN150NST	74.25

Sweeper Nozzle

Thread Size	Discharge	Length	Previous Part #	Brass Part #	Price/E
3/4" GHT	3/16"	2"	500SN2	PSN76	\$7.75



Flexible Water Nozzle

Features:

- bends for water flow, shuts off when released
- 3/4" GHT

Part #	Price/E
8005	\$41.15



Brass / Rubber Power Flow Water Nozzle

Features:

- all metal body and handle
- curved design to fit the contour of your hand
- overmold for comfortable handling
- built in flow control to regulate the amount of water flow
- locking feature to make extended watering easy
- large easy-turn dial

Thread Size	Part #	Price/E
3/4" GHT	PNB75GHT	\$39.80



Insulated Water Nozzles

Features:

- clip locks to any spray pattern
- industrial strength nylon handle
- rubber handle guard
- GHT thread on head
- heavy duty brass valve and adjusting nut
- for use with hot water up to **140°F (60°C)**

Thread Size	Part #	Price/E
3/4" GHT	SN75	\$23.50



Pistol-Grip Water Nozzle

Features:

- clip locks to any spray pattern
- easy squeeze on/off lever
- brass valve and adjusting nut
- stainless steel spring with lifetime packing
- rubber handle guard

Thread Size	Part #	Price/E
3/4" GHT	CSN75	\$13.45



Twist Nozzles

Feature:

- maximum operating pressure **150 PSI** (water only)

Thread Size	Length	Previous Part #	Extruded Brass Part #	Price/E
3/4" GHT	4"	---	BTN75	\$21.80
	4"	---	500AN4 ¹	13.05
	6 3/4"	500-AN7	500AN7 ¹	37.98



¹ imported

Adjust-A-Power Nozzle



Features:

- ideal for patio, auto and boat, driveway and garden
- produces 50% more power than twist nozzles
- does not require a washer
- leave nozzle in the open position when not in use
- brass construction with stainless steel bearings
- maximum operating pressure: **100 PSI** (water only) at ambient temperature **70°F (21°C)**

Thread Size	Part #	Brass	Price/E
3/4" GHT	AAPN75GHT		\$24.00

Constant Flow Nozzle Displays



Features:

- shatterproof and UV resistant polycarbonate withstands tough environmental conditions
- seals used for true water shut off
- easy twist spray pattern adjustment
- sold in case quantity only (25 per case), with display

Thread	45° Spray GPM @ 100 PSI	Color	Global Part #	Price/E
3/4" GHT	25.1	green	FNB75GHT-GD	\$493.00
	25.1	clear	CNB75GHT-GD	493.00

Constant Flow Nozzles with Bumper



Feature:

- can be used as a replacement nozzle in the display case **FNB75GHT-GD**

Thread	45° Spray GPM @ 100 PSI	Color	Plastic Part #	Price/E
3/4" GHT	8.0	green	GNB75GHT (domestic)	\$26.20
	25.1	clear	CNB75GHT (global)	21.20



Water-Steam Washdown Station

Applications:

- Fail-safe mixing station safely blends steam and cold water for hot water on demand. Should cold water fail, the steam is instantly shut-off.

Features:

- control valves (globe style)
- dial thermometer
- in-line check valves
- ¾" inlet and outlet
- stainless steel hose rack
- mounting plate and hardware for wall mounting
- maximum operating pressure: **150 PSI**
- maximum temperature: **200°F (93°C)**

Part #	Bronze	Price/E
SWDS		\$3633.95

Pressure Requirements

Steam Pressure		Water Pressure	
Minimum 80 PSI	Maximum 90 PSI	Minimum 50 PSI	Maximum 80 PSI



station is not supplied with hose and nozzle

Hot and Cold Water Mixing Station

Features:

- control valves (globe style)
- in-line check valves
- ¾" inlet and outlet
- stainless steel hose rack
- mounting plate and hardware for wall mounting
- maximum operating pressure: **150 PSI**
- maximum temperature: **200°F (93°C)**

Part #	Bronze	Price/E
WDS1		\$1283.70



station is not supplied with hose and nozzle

Rack for Mixing Station

Features:

- stainless steel lag screws
- solid brass mounting crowns
- supplied with mounting hardware
- rack fits SWDS and WDS1 mixing stations
- holds 50' of ¾" heavy duty industrial grade hose

Part #	Stainless Steel	Price/E
WDSR		\$211.20



Pressure Washing

Spray Guns

Anti-Fatigue Spray Gun



Features:

- 3/8" female inlet
- 1/4" female outlet
- temperatures to **300°F (149°C)**
- anti-fatigue pressure compensating design

Maximum PSI	GPM	Part #	Price/E
5075	12.0	HPSG	\$81.40
5000	10.6	HPSGW¹	95.00

¹ W = weeping, for the car wash industry, allows a small stream of water / leak



Pressure Spray Gun

Features:

- 3/8" female inlet
- 1/4" female outlet
- working pressure: **4500 PSI**
- maximum temperature to **320°F (160°C)**

GPM	Part #	Price/E
8	HPSGL	\$67.60

Heavy Duty Anti-Fatigue Spray Gun



Features:

- 3/8" female inlet
- 1/4" female outlet
- working pressure: **5000 PSI**
- maximum temperature: **300°F (149°C)**
- heavy duty anti-fatigue design
- stainless inner tube
- Zytel® housing

GPM	Part #	Price/E
8	HPSGHD	\$103.75

Pressure Spray Gun with Extension



Features:

- 3/8" female inlet
- 22 mm x 14 mm female outlet
- working pressure: **3700 PSI**
- maximum temperature: **140°F (60°C)**
- extension length: 19"

GPM	Part #	Price/E
8	AL9	\$73.00

Pressure Spray Gun Kit with Hose, Nozzle & Lance



Features:

- gun: 22 mm male inlet, 22 mm x 14 mm female outlet end, working pressure **2500 PSI**
- lance: 18" with vari-spray nozzle 1.25 mm with 22 mm male inlet
- hose: 25', 1/4" ID with 22 mm x 14 mm female ends
- nozzle: 4.0 variable nozzle 0° to 80°

Part #	Price/E
BIT-KIT	\$188.00

Spray Lances and Extensions for Pressure Gun

Spray Lance

Features:

- for use with **AL9** spray gun *only*
- maximum operating pressure: **4000 PSI**
- maximum temperature: **300°F (149°C)**



Length	Description	Part #	Zinc	Price/E
24"	22 mm x 14 mm male inlet x 1/4" male outlet	AL248		\$26.00

Dual Spray Lances

Features:

- for use with **HPSG, HPSGC, HPSGHD** and **HPSGW**
- for soap and water
- maximum temperature: **300°F (149°C)**
- **10.5 GPM**
- requires 1 high pressure nozzle and 1 soap nozzle on page K-36
- Allows quick adjustment from high to low pressure with a twist of the handle; low pressure setting allows for use of soap.



AL333



AL344

Length	Description	Maximum Operating PSI	Part #	Price/E
40"	<i>zinc</i> , 1/4" male inlet 2 each 1/4" female outlets	3,650	AL333	\$136.50
	<i>stainless steel</i> , 1/4" male inlet, 2 each 1/4" female outlets	4,000	AL344	186.15

Molded Grip Extensions

Features:

- for use with **HPSG, HPSGC, HPSGHD** and **HPSGW**
- maximum operating pressure: **5000 PSI**
- temperature: **300°F (149°C)**
- **10.5 GPM** maximum

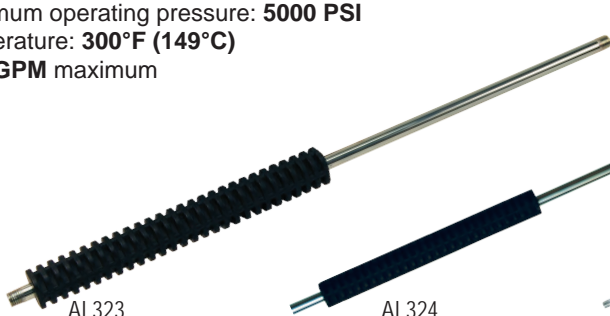

AL323

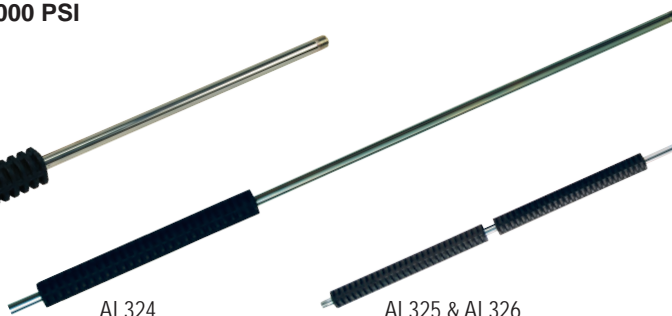

AL324



AL325 & AL326

Length	Description	Part #	Zinc	Price/E
24"	1/4" male inlet x 1/4" male outlet	AL323XX		\$21.55
36"	1/4" male inlet x 1/4" male outlet, 4" space from the end	AL324XX		25.05
48"	1/4" male inlet x 1/4" male outlet, 2 grips	AL325XX		43.75
59"	1/4" male inlet x 1/4" male outlet, 2 grips	AL326XX		48.70

Vented Grip Lances

Features:

- for use with **HPSG, HPSGC, HPSGHD** and **HPSGW**
- for hot water
- maximum operating pressure: **5000 PSI**
- maximum temperature: **300°F (149°C)**
- **10.5 GPM** maximum



AL361



AL362

Length	Description	Part #	Zinc	Price/E
36"	1/4" male inlet x 1/4" female outlet, straight	AL361		\$49.90
48"	1/4" male inlet x 1/4" female outlet, bent	AL362		75.00

Telescoping Lance and Belt for Pressure Gun



Features:

- 3/8" female (pipe thread) inlet
- 1/4" female (quick connect) outlet
- maximum operating pressure: **4000 PSI**
- 1/4" steel braided hose
- **7 GPM**
- length is in three sections
- maximum temperature: **300°F (149°C)**

Length	Aluminum	
	Part #	Price/E
6' - 18'	ARTEL18A	\$553.70

Telescoping Lance Belt



Feature:

- adjusts to fit a 33" to 58" waist

Part #	Nylon	
	Price/E	
ARTEL-BELT	\$56.60	

Swiveling Quick Couplings

Features:

- working pressure: **3650 PSI**
- **7.8 GPM**
- maximum temperature: **300°F (149°C)**

1/4" swiveling quick couplings



Description	Part #	Price/E
1/4" female x 22 mm x 1.5 mm swivel	AL450 ¹	\$16.40

¹ for use with **AL456** only



Description	Part #	Price/E
1/4" male x 22 mm x 1.5 mm swivel	AL451 ²	\$16.40

² for use with **AL464** only

3/8" swiveling quick couplings



Description	Part #	Price/E
3/8" female x 22 mm x 1.5 mm swivel	AL453 ¹	\$19.35

¹ for use with **AL456** only



Description	Part #	Price/E
3/8" female x female swivel	AL462 ²	\$31.60

² for use with **AL464** only

Fixed Plugs

Features:

- working pressure: **3650 PSI**
- **7.8 GPM**
- maximum temperature: **300°F (149°C)**

1/4" fixed quick coupling plugs

Description	Part #	Price/E
1/4" female x 22 mm x 1.5 mm male	AL454 ¹	\$11.75

¹ for use with **AL453** and **AL9**



Description	Part #	Price/E
1/4" male x 22 mm x 1.5 mm male	AL455F ²	\$11.75

² for use with **AL462** only



3/8" fixed quick coupling plugs

Description	Part #	Price/E
3/8" female x 22 mm x 1.5 mm male	AL456 ¹	\$15.10

¹ for use with **AL453** and **AL9**



Description	Part #	Price/E
3/8" female x male plug	AL464 ²	\$17.60

² for use with **AL462** only



Injector Nozzles

Features:

- designed to inject cleaning solutions into high pressure discharge lines
- 3/8" male inlet and outlet
- maximum working pressure: **4000 PSI**

Description	Orifice	Flow (GPM)	Part #	Price/E
adjustable, green	1.8 mm	2 - 3	AL472	\$52.85
adjustable, red	2.1 mm	3 - 4	AL477	53.25
adjustable, blue	2.3 mm	4 - 5.5	AL478	53.25



AL477

Line Strainer

Features:

- working pressure: **100 PSI**
- 1/2" female inlet, 1/2" male outlet
- .60 mesh cuffed filter
- 2 additional 1/4" side ports
- **8 GPM** maximum

Aluminum		Price/E
Part #		
AR3000-A2		\$48.90



High Pressure Spray Soap Nozzles



Description	Brass	
	Part #	Price/E
¼" male inlet, 40° spray angle, size #40	NZ4040S	\$10.80
¼" male inlet, 80° spray angle, size #40	NZ8040S	10.80

High Pressure Spray Nozzles



Description	Steel	
	Part #	Price/E
¼" male NPT inlet, 15° spray angle, size 4	NZ1504	\$16.20
¼" male NPT inlet, 25° spray angle, size 4	NZ2504	16.20
¼" male NPT inlet, 40° spray angle, size 4	NZ4004	16.20

Quick Connect Soap Nozzle



- use with ¼" couplers on page H-37

Description	Brass	
	Part #	Price/E
¼" straight through plug inlet, 65° spray angle, size #40	NZ6540QCS	\$15.20

Quick Connect Spray Nozzles



- use with ¼" couplers on page H-37

Description	Part #	Price/E
¼" straight through plug inlet, 0° spray angle, size #4, red	MSP400	\$18.80
¼" straight through plug inlet, 15° spray angle, size #4, yellow	MSP415	16.50
¼" straight through plug inlet, 25° spray angle, size #4, green	MSP425	16.50
¼" straight through plug inlet, 40° spray angle, size #4, white	MSP440	16.50

Multi-Pack Quick Connect Nozzles



Description	Nozzles Included	Part #	Price/E
¼", 65° spray angle, size #40	NZ6540QCS	MSP4PAK	\$65.25
¼", 15° spray angle, size #4, yellow	MSP415		
¼", 25° spray angle, size #4, green	MSP425		
¼", 40° spray angle, size #4, white	MSP440		

Multi-Pack High Pressure Spray Nozzles

- ¼" quick connect nozzle multi-packs include: 0° red, 15° yellow, 25° green, 40° white and 50° black soap nozzles
- ¼" MEG nozzle multi-packs include: 0°, 15°, 25°, 40° and 65° soap nozzles



Nozzle Size	GPM @ PSI									Part #	Price/E
	800	1000	1500	2000	2500	3000	3500	4000	5000		
3.0	1.34	1.50	1.84	2.12	2.37	2.60	2.81	3.00	3.35	NZMQC5P-030	\$50.30
3.5	1.57	1.75	2.14	2.47	2.77	3.03	3.27	3.50	3.91	NZMQC5P-035	50.30
4.0	1.79	2.00	2.45	2.83	3.16	3.46	3.74	4.00	4.47	NZMQC5P-040	50.30
4.5	2.01	2.25	2.76	3.18	3.56	3.90	4.21	4.50	5.03	NZMQC5P-045	50.30
5.0	2.24	2.50	3.06	3.54	3.95	4.33	4.68	5.00	5.59	NZMQC5P-050	50.30
5.5	2.46	2.75	3.37	3.89	4.35	4.76	5.14	5.50	6.15	NZMQC5P-055	50.30
6.5	2.91	3.25	3.98	4.60	5.14	5.63	6.08	6.50	7.27	NZMQC5P-065	50.30
8.0	3.58	4.00	4.90	5.66	6.32	6.93	7.48	8.00	8.94	NZMQC5P-080	50.30



Nozzle Size	GPM @ PSI									Part #	Price/E
	800	1000	1500	2000	2500	3000	3500	4000	5000		
3.5	1.57	1.75	2.14	2.47	2.77	3.03	3.27	3.50	3.91	NZMMEG5P-035	\$52.50
4.0	1.79	2.00	2.45	2.83	3.16	3.46	3.74	4.00	4.47	NZMMEG5P-040	52.50
4.5	2.01	2.25	2.76	3.18	3.56	3.90	4.21	4.50	5.03	NZMMEG5P-045	52.50
5.0	2.24	2.50	3.06	3.54	3.95	4.33	4.68	5.00	5.59	NZMMEG5P-050	52.50
5.5	2.46	2.75	3.37	3.89	4.35	4.76	5.14	5.50	6.15	NZMMEG5P-055	52.50

Spray Nozzle Selection Guidelines

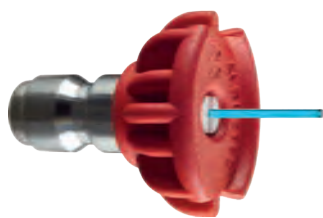

**0°
Blasting Nozzle**

- Removing caked on mud from heavy construction, farm or lawn equipment.
- Cleaning tar, glue or stubborn stains from concrete
- Cleaning overhead areas
- Removing rust from steel and oxidation from aluminum

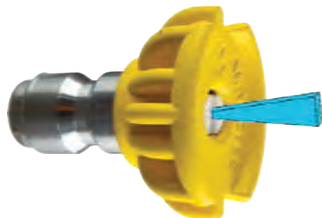

**15°
Stripping Nozzle**

- Removing paint from wood, masonry or metal
- Removing grease or dirt from equipment
- Removing heavy mildew stains
- Removing marine growth from boats and marine equipment
- Removing rust from steel and oxidation from aluminum



**25°
Cleaning Nozzle**

- General cleaning of dirt, mud and grime
- Cleaning roofs, gutters and downspouts
- Removing light mildew stains
- Removing algae and bacteria build-up from pools
- Rinsing surfaces in preparation for painting



**40°
Washing Nozzle**

- Light cleaning and washing
- Washing and rinsing of automobiles and boats
- Cleaning roofs, windows, patios and driveways



Caution: The spray force from these nozzles can cause injuries if pointed directly at yourself or others. Before observing directly always disconnect from spray wand. Make sure spray nozzle is properly locked in place with its quick coupler, if the collar is not in the locking position, the nozzle will become a dangerous projectile. The O-ring from your quick coupler socket will also be blown out of place.

Nozzle Spray Chart

Nozzle Orifice Size	→ Gallons per Minute →	1000	1200	1250	1300	1500	1800	2000	2100	2200	2300	2400	2500	3000	3200	3500	4000	5000
		PSI	PSI	PSI	PSI	PSI	PSI	PSI	PSI	PSI	PSI	PSI	PSI	PSI	PSI	PSI	PSI	PSI
3.0		1.50	1.64	1.68	1.71	1.84	2.01	2.12	2.17	2.22	2.27	2.32	2.37	2.60	2.68	2.81	3.00	3.35
3.5		1.75	1.92	1.96	2.00	2.14	2.35	2.47	2.54	2.60	2.65	2.71	2.77	3.03	3.13	3.27	3.50	3.91
4.0		2.00	2.19	2.24	2.28	2.45	2.68	2.83	2.90	2.97	3.03	3.10	3.16	3.46	3.58	3.74	4.00	4.47
4.5		2.25	2.46	2.52	2.57	2.76	3.02	3.18	3.26	3.34	3.41	3.49	3.56	3.90	4.02	4.21	4.50	5.03
5.0		2.50	2.74	2.80	2.85	3.06	3.35	3.54	3.62	3.71	3.79	3.87	3.95	4.33	4.47	4.68	5.00	5.59
5.5		2.75	3.01	3.07	3.14	3.37	3.69	3.89	3.99	4.08	4.17	4.26	4.35	4.76	4.92	5.14	5.50	6.15
6.5		3.25	3.56	3.63	3.71	3.98	4.36	4.60	4.71	4.82	4.93	5.03	5.14	5.63	5.81	6.08	6.50	7.27
8.0		4.00	4.38	4.47	4.56	4.90	5.37	5.66	5.80	5.93	6.07	6.20	6.32	6.93	7.16	7.48	8.00	8.94



Turbo Nozzles

Features:

- 15° spray angle
- maximum temperature: **195°F (91°C)**
- ceramic orifice



Nozzle Size	Description	Orifice	Maximum Working PSI	Part #	Price/E
4.0	¼" female inlet, dk. green	1.30 mm	3,625	AL-TPR25-30	\$186.00
5.5 - 6.0	¼" female inlet, purple	1.50 mm	3,625	AL-TPR25-50	186.00
7.0 - 7.5	¼" female inlet, grey	1.70 mm	3,625	AL-TPR25-70	186.00
4.0	¼" female inlet, dk. green	1.30 mm	5,075	AL-TPR35-30	282.00
5.5	¼" female inlet, purple	1.50 mm	5,075	AL-TPR35-50	282.00
6.5	¼" female inlet, grey	1.70 mm	5,075	AL-TPR35-70	282.00

Nozzle Holders



AL414



AL416

Feature:

- maximum temperature: **300°F (149°C)**

Description	Flow (GPM)	Working PSI	Part #	Price/E
adjustable hi/low nozzle holder with nozzle protector, ¼" female inlet and outlet	7.8	3,650	AL414	\$47.25
change over nozzle, ¼" female inlet, 2 each ¼" female outlets	8	2,900	AL416	64.50

Inlet Filter for Turbo Nozzles



Features:

- ¼" female inlet, ¼" male outlet
- maximum temperature: **212°F (100°C)**
- 100 mesh filter

Description	Flow (GPM)	Working PSI	Part #	Price/E
stainless steel, inlet water filter	8	5,000	AR3500	\$38.20



Unloader Valves

Features:

- automatically relieves pressure from the pump at shut-off
- maximum temperature: **190°F (88°C)**
- inlet: 2 each, 3/8" female NPT
- outlet: 3/8" female NPT
- bypass: 2 each, 3/8" female NPT

Description	Maximum Flow (GPM)	Working PSI	Part #	Price/E
yellow spring	8	2,320	AL605	\$172.50
blue spring	8	3,650	AL606	172.50
black spring	8	4,500	AL607	174.40



Features:

- maximum temperature: **190°F (88°C)**
- inlet: 3/8" female
- outlet: 3/8" male
- bypass: 3/8" female

Description	Flow (GPM)	Working PSI	Part #	Price/E
VR-35 unloader valve	9	5,100	AR20831	\$220.00



Thermal Relief Valve

Features:

- operating PSI: **200 PSI**
- maximum temperature: **140°F (60°C)**
- inlet: 1/2" male

Part #	Brass	Price/E
TPP140		\$22.70



Safety Release Valve

Features:

- pressure range: **1,000 to 4,000 PSI**
- maximum temperature: **200°F (93°C)**
- inlet: 3/8" male
- GPM: **6**

Part #	Price/E
AR5000-1	\$35.00



Balance Release Valve



Features:

- working PSI: **4,000 PSI**
- maximum temperature: **195°F (90.6°)**
- GPM: **6.6**
- inlet/outlet: **3/8" female NPT**
- bypass: **3/8" female NPT**

Part #	Brass	Price/E
AL702		\$107.80

Water Broom



Features:

- working PSI: **4,000 PSI**
- **1/4" quick connect plug**

Description	Length	Stainless Steel	
		Part #	Price/E
4 nozzle broom	16"	AR-BROOM16	\$139.50



Mill Hose L-2 to L-5

- Synthetic Single Jacket L-2 to L-4
- Synthetic Double Jacket L-5

Washdown Hose..... L-6 to L-8

- Nitrile L-6 to L-8
- Hot Water L-8
- Pressure Washer Braided L-8
- Hand Crank Hose Reel..... L-8

Fire Hose L-9 to L-17

- 300# Single Jacket All Polyester Fire L-9
- 500# Single Jacket All Polyester Fire L-10 to L-11
 - UL Labeled..... L-10
 - Color Impregnated L-11
- 800# Double Jacket All Polyester Fire..... L-11
 - Impregnated..... L-11
- MSHA Approved Single Jacket Mine Fire..... L-12
- Double Jacket Potable Water Hose - Blue L-12
- 500# All Polyester Rack..... L-13
 - UL Labeled..... L-13
 - non-UL Labeled L-13
- 500# Nitrile Covered Fire Hose - Light Duty Red L-13
- Forestry Non-Weeping L-14
- Forestry Mop Up..... L-14
- Forestry Mop Up Kit..... L-14
- Nitrile Covered Fire Hose - Heavy Duty - Yellow L-15
- Non-collapsible Chemical Booster Hose - Red L-16
- Non-collapsible Fire and Utility Hose - Red L-17

Racks & Reels..... L-18 to L-26

- Style V Swing Type Hose Storage Reels L-18
- Swing Type Hose Storage Reels L-19
- Heavy Duty Swing Type Hose Storage Reel L-19
- Global Continuous Flow Reels L-20
- Continuous Flow Reels L-21
- Hump Racks L-22
- Hose Racks L-22
- Hung Up On Dixon® Hose Racks L-22
- Pin Rack Hose Assembly L-23
- Semi Automatic Fire Hose Pin Racks L-23
- Steel Hose Cabinet L-24
- Reelcraft® 5000 Series Spring Driven Hose Reels L-25
- Reelcraft® 7000 Series L-25
- Reelcraft® 80000 Series L-26
- Adjustable Hose Bumper Stops..... L-26
- Reelcraft® 30,000 Manual Driven Hose Reels L-26

Garden Hose & Washdown..... L-27 to L-29

- Contractors EPDM Water Hose..... L-27
- Rubber Vinyl Garden Hose..... L-27
- Premium EPDM Hose L-27
- Flexogen® Hose L-27
- Perfect Water Hose L-28
- Premium Flexzilla® Garden Hose..... L-28
- Top Level PVC Hose L-28
- Hot Water Rubber Reinforced Hose..... L-28
- Marine, Camper, Patio & Pool Hose..... L-29
- Country Club® RT Hose L-29

Flexible Tubing..... L-30 to L-33

- PVC Tubing L-30
- PVC Braided Tubing..... L-31
- D.O.T. Air Brake Tubing Rolls L-31
- Polyurethane Tubing..... L-32
- Polyethylene Tubing L-32
- Nylon Tubing L-32
- Legris Nylon Tubing L-33
- Polyurethane - 95 Durometer Tubing L-33
- Fluoropolymer FEP 140 Tubing L-33

Air Hose..... L-34 to L-35

- Coil-Chief Self-Storing Air Hose L-34
- Polyurethane Self-Storing Air Hose..... L-35
- Polyurethane Air Hose..... L-35

Tubing & Hose Cutters L-36

PTFE Hose L-37 to L-38

- Nominal L-37
- True ID..... L-38

Hose Protection L-39 to L-42

- Spiral Hose and Cable Protection L-39
- Fiberglass Sleeving L-40
- Kevlar® Protective Sleeves L-40
- Nylon Protective Sleeves - MSHA Accepted L-40
- Fire Jacket for Hose L-41
- Fire Jacket Tape L-41
- Non Adhesive Fire Tape L-41
- Spring Guard L-42
- Continuous Spring Guard..... L-42



Synthetic Single Jacket Mill Hose

Hose & Tubing

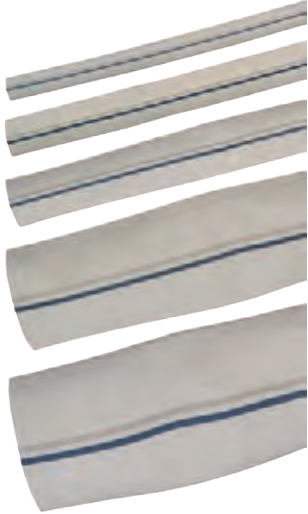

Application:

- Used in open end water discharge applications only. Not intended for fire fighting service.



Features:

- outer construction: single jacket, all polyester
- tube construction: black, PVC rubber
- rated pressure: **250 PSI** at ambient temperature **70°F (21°C)**
- working pressure: **112 PSI** at ambient temperature **70°F (21°C)**
- Consult Dixon® for pricing and availability on 75' lengths and other threads and configurations.

Uncoupled

Size	Bowl	Length	Part #	Price/E
1"	1-1/4"	50'	<i>M10-50UC</i>	\$91.55
	1-1/4"	100'	<i>M10-100UC</i>	183.00
	1-1/4"	300'	<i>M10-300UC</i>	480.10
1½"	1-11/16"	25'	<i>M15-25UC</i>	50.45
	1-11/16"	50'	<i>M15-50UC</i>	101.00
	1-11/16"	100'	<i>M15-100UC</i>	202.00
2"	2-3/8"	25'	<i>M20-25UC</i>	58.30
	2-3/8"	50'	<i>M20-50UC</i>	117.00
	2-3/8"	100'	<i>M20-100UC</i>	234.00
2½"	2-11/16"	25'	<i>M25-25UC</i>	80.75
	2-11/16"	50'	<i>M25-50UC</i>	161.00
	2-11/16"	100'	<i>M25-100UC</i>	323.00
3"	3-3/8"	25'	<i>M30-25UC</i>	96.60
	3-3/8"	50'	<i>M30-50UC</i>	193.00
	3-3/8"	100'	<i>M30-100UC</i>	387.00
4"	4-3/8"	25'	<i>M40-25UC</i>	147.00
	4-3/8"	50'	<i>M40-50UC</i>	294.00
	4-3/8"	100'	<i>M40-100UC</i>	588.00
6"	6-3/8"	25'	<i>M60-25UC</i>	259.00
	6-3/8"	50'	<i>M60-50UC</i>	518.00



Synthetic Single Jacket Mill Hose

Application:

- Used in open end water discharge applications only. Not intended for fire fighting service.



Features:

- outer construction: single jacket, all polyester
- tube construction: black, PVC rubber
- rated pressure: **250 PSI** at ambient temperature **70°F (21°C)**
- working pressure: **125 PSI** at ambient temperature **70°F (21°C)**
- Consult Dixon® for pricing and availability on 75' lengths and other threads and configurations.

Coupled with NPSH female and male expansion ring couplings

Size	Length	Part #	Price/E
1½"	50'	<i>M15-50RAS</i>	\$194.75
	100'	<i>M15100RAS</i>	284.40
2"	50'	<i>M20-50RAS</i>	284.40
	100'	<i>M20100RAS</i>	383.30
2½"	50'	<i>M25-50RAS</i>	315.30
	100'	<i>M25100RAS</i>	474.50



Coupled with NST (NH) female and male expansion ring couplings

Size	Length	Part #	Price/E
1½"	50'	<i>M15-50RAF</i>	\$194.75
	100'	<i>M15100RAF</i>	284.40
2½"	25'	<i>M25-25RAF</i>	225.25
	50'	<i>M25-50RAF</i>	315.30
	100'	<i>M25100RAF</i>	474.50



Coupled with MNPT x MNPT male expansion ring couplings

Size	Length	Part #	Price/E
1½"	50'	<i>M15-50RAT</i>	\$234.40
	100'	<i>M15100RAT</i>	329.90
2"	50'	<i>M20-50RAT</i>	284.40
	100'	<i>M20100RAT</i>	393.80



Synthetic Single Jacket Mill Hose

Application:

- used in open end water discharge applications only, not intended for fire fighting service



Features:

- outer construction: single jacket, all polyester
- tube construction: black, PVC rubber
- Consult Dixon® for pricing and availability of additional lengths and other configurations.

Coupled with NPSH female and male King™ short shank couplings, crimp sleeve, aluminum shank with brass pin lug swivel nut

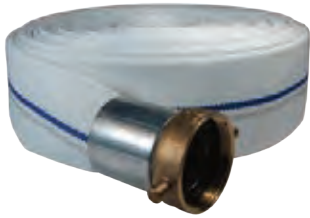

Size	Length	Working Pressure PSI at 70°F (21°C)	Part #	Price/E
1½"	25'	75	M15-25KAS	\$113.35
	50'	75	M15-50KAS	159.50
2"	25'	75	M20-25KAS	115.00
	50'	75	M20-50KAS	179.30
2½"	25'	50	M25-25KAS	177.90
	50'	50	M25-50KAS	230.30
3"	25'	50	M30-25KAS	203.75
	50'	50	M30-50KAS	291.10

Coupled with NST (NH) female and male King™ short shank couplings, crimp sleeve, aluminum shank with brass pin lug swivel nut

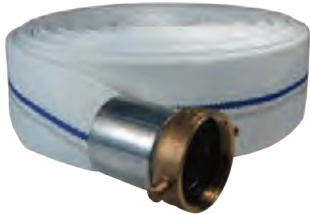

Size	Length	Working Pressure PSI at 70°F (21°C)	Part #	Price/E
1½"	25'	75	M15-25KAF	\$113.35
	50'	75	M15-50KAF	160.35
2½"	25'	50	M25-25KAF	177.90
	50'	50	M25-50KAF	254.70

Coupled with female and male (C & E) global aluminum cam and groove, crimp sleeve



Size	Length	Working Pressure PSI at 70°F (21°C)	Part #	Price/E
1½"	25'	112	M15-25GAX	\$124.75
	50'	112	M15-50GAX	185.25
2"	25'	112	M20-25GAX	142.35
	50'	112	M20-50GAX	199.40
2½"	25'	112	M25-25GAX	174.45
	50'	112	M25-50GAX	245.75
3"	25'	112	M30-25GAX	217.30
	50'	112	M30-50GAX	272.30
4"	25'	112	M40-25GAX	275.10
	50'	112	M40-50GAX	448.35

Synthetic Double Jacket Mill Hose

Application:

- ideal for open end discharge applications, not intended for fire fighting service 

Features:

- outer construction: double jacket, all polyester
- tube construction: black, PVC rubber
- rated pressure: **250 PSI at 70°F (21°C)**
- working pressure: **200 PSI at 70°F (21°C)**
- double jacket hoses are **not** recommended for use with field reattachable couplings 
- Consult Dixon® for pricing and availability of additional lengths and other configurations.

Uncoupled

Size	Bowl	Length	Part #	Price/E
1½"	1-13/16"	50'	DM15-50UC	\$181.00
	1-13/16"	100'	DM15-100UC	363.00
2"	2-5/16"	50'	DM20-50UC	223.00
	2-5/16"	100'	DM20-100UC	445.00
2½"	2-7/8"	50'	DM25-50UC	268.00
	2-7/8"	100'	DM25-100UC	537.00



Coupled with female and male NST (NH) thread, rocker lug, aluminum expansion ring couplings

Size	Bowl	Length	Part #	Price/E
1½"	1-13/16"	50'	DM15-50RAF	\$236.50
	1-13/16"	100'	DM15100RAF	435.85
2½"	2-7/8"	50'	DM25-50RAF	376.70
	2-7/8"	100'	DM25100RAF	647.55



Coupled with female and male NPSH thread, rocker lug, aluminum expansion ring couplings

Size	Bowl	Length	Part #	Price/E
1½"	1-13/16"	50'	DM15-50RAS	\$236.50
	1-13/16"	100'	DM15100RAS	435.85
2"	2-5/16"	50'	DM20-50RAS	314.40
	2-5/16"	100'	DM20100RAS	480.25
2½"	2-7/8"	50'	DM25-50RAS	371.55
	2-7/8"	100'	DM25100RAS	647.55



Coupled with female and male NPT thread, rocker lug, aluminum expansion ring couplings

Size	Bowl	Length	Part #	Price/E
1½"	1-13/16"	50'	DM15-50RAT	\$236.50
	1-13/16"	100'	DM15100RAT	435.85
2"	2-5/16"	50'	DM20-50RAT	314.40
	2-5/16"	100'	DM20100RAT	480.25
2½"	2-7/8"	50'	DM25-50RAT	371.55



Nitrile Washdown Hose

Hose & Tubing

Applications:

- ideal for industrial, agricultural and construction washdown and discharge applications, not for firefighting



Features:

- resistant to weather and abrasion
- working pressure: **200 PSI**

Coupled with NPSH female and male expansion ring couplings



Size	Length	Part #	Price/E
1½"	50'	WDH15BK50RAS	\$325.10
	100'	WDH15BK100RAS	548.45
2"	50'	WDH20BK50RAS	394.60
	100'	WDH20BK100RAS	646.60
2½"	50'	WDH25BK50RAS	503.45
	100'	WDH25BK100RAS	646.60

Coupled with NST female and male expansion ring couplings



Size	Length	Part #	Price/E
1½"	50'	WDH15BK50RAF	\$325.10
	100'	WDH15BK100RAF	548.45
2½"	25'	WDH25BK25RAF	327.30
	50'	WDH25BK50RAF	503.45
	100'	WDH25BK100RAF	646.60

Coupled with MNPT x MNPT male expansion ring couplings



Size	Length	Part #	Price/E
1½"	50'	WDH15BK50RAT	\$325.10
	100'	WDH15BK100RAT	548.45
2"	50'	WDH20BK50RAT	394.60
	100'	WDH20BK100RAT	670.10



Nitrile Washdown Hose

Applications:

- ideal for industrial, agricultural, chemical and construction washdown and discharge applications, not for firefighting



Feature:

- resistant to weather and abrasion

Coupled with NPSH female and male King™ short shank couplings, crimp sleeve, aluminum shank with brass pin lug swivel nut

Size	Length	Part #	Price/E
1½"	25'	<i>WDH15BK25KAS</i>	\$271.00
	50'	<i>WDH15BK50KAS</i>	325.10
2"	25'	<i>WDH20BK25KAS</i>	227.90
	50'	<i>WDH20BK50KAS</i>	353.90
2½"	25'	<i>WDH25BK25KAS</i>	310.70
	50'	<i>WDH25BK50KAS</i>	486.85
3"	25'	<i>WDH30BK25KAS</i>	408.95
	50'	<i>WDH30BK50KAS</i>	635.15



Coupled with NST (NH) female and male King™ short shank couplings, crimp sleeve, aluminum shank with brass pin lug swivel nut

Size	Length	Part #	Price/E
1½"	25'	<i>WDH15BK25KAF</i>	\$220.85
	50'	<i>WDH15BK50KAF</i>	332.50
2½"	25'	<i>WDH25BK25KAF</i>	328.50
	50'	<i>WDH25BK50KAF</i>	504.60



Coupled with female and male (C & E) global aluminum cam and groove, crimp sleeve

Size	Length	Part #	Price/E
1½"	25'	<i>WDH15BK25GAX</i>	\$187.60
	50'	<i>WDH15BK50GAX</i>	325.10
2"	25'	<i>WDH20BK25GAX</i>	255.55
	50'	<i>WDH20BK50GAX</i>	381.55
2½"	25'	<i>WDH25BK25GAX</i>	278.50
	50'	<i>WDH25BK50GAX</i>	454.65
3"	25'	<i>WDH30BK25GAX</i>	342.65
	50'	<i>WDH30BK50GAX</i>	568.90
4"	25'	<i>WDH40BK25GAX</i>	484.30
	50'	<i>WDH40BK50GAX</i>	777.85



Nitrile Washdown Hose

Hose & Tubing

Applications:

- ideal for industrial, agricultural and construction washdown and discharge applications, not for firefighting 

Feature:

- resistant to weather and abrasion

Uncoupled



Size	Color	Bowl	Length	Working Pressure	Part #	Price/E
1"	black	1 1/4"	50'	200 PSI	<i>WDH10BK50UC</i>	\$334.60
	black	1 1/4"	100'		<i>WDH10BK100UC</i>	669.20
	yellow	1 1/4"	100'		<i>WDH10Y100UC</i>	669.20
	blue	1 1/4"	100'		<i>WDH10BL100UC</i>	669.20
1 1/2"	black	1-13/16"	50'		<i>WDH15BK50UC</i>	225.95
	black	1-13/16"	100'		<i>WDH15BK100UC</i>	451.90
2"	black	2-5/16"	50'		<i>WDH20BK50UC</i>	251.40
	black	2-5/16"	100'		<i>WDH20BK100UC</i>	502.80
2 1/2"	black	2-13/16"	50'		<i>WDH25BK50UC</i>	352.15
	black	2-13/16"	100'		<i>WDH25BK100UC</i>	704.30
3"	black	3 3/8"	50'	150 PSI	<i>WDH30BK50UC</i>	601.80
	black	3 3/8"	100'		<i>WDH30BK100UC</i>	1203.60
4"	black	4 3/8"	50'		<i>WDH40BK50UC</i>	742.10
	black	4 3/8"	100'		<i>WDH40BK100UC</i>	1484.20
6"	black	6 3/8"	50'		<i>WDH60BK50UC</i>	977.45
	black	6 3/8"	100'		<i>WDH60BK100UC</i>	1954.90

Hot Water Washdown Hose

Features:

- smooth extruded Chlorobutyl tube
- white, wrapped Hypalon cover (.075" thick) with braided textile reinforcement
- furnished with internal stainless steel spring guards at both ends
- 3/4" male on one end and 1/2" male on the other
- working pressure: **250 PSI**
- maximum temperature: **200°F (93°C)**



Hose ID x Length	Part #	Price/E
5/8" x 25'	<i>SWDSHOSE25</i>	\$794.05
5/8" x 50'	<i>SWDSHOSE50</i>	1340.95

Pressure Washer Braided Hose



ID	Male Swivel Inlet	Male Swivel Outlet	Pressure Rating (PSI)	Length	Rubber	
					Part #	Price/E
3/8"	3/8"	3/8"	4,000	50'	<i>AR503830SSP</i>	\$242.65

Hand Crank Hose Reel

Features:

- working PSI: **3,000 PSI**
- maximum temperature: **160°F (71°C)**
- 3/8" outlet, 3/8" inlet
- includes jumper hose, mounting bracket and crank handle
- holds 100' of 3/8" pressure hose



Part #	Steel	Price/E
<i>AR-REEL100</i>		\$406.00

300# Single Jacket All Polyester Fire Hose

Features:

- outer construction: single jacket, all polyester
- tube construction: EPDM rubber lining
- proof pressure: **300 PSI**
- service test pressure: **150 PSI** at ambient temperature **70°F (21°C)**
- working pressure: **135 PSI** at ambient temperature **70°F (21°C)**
- 25' and 75' lengths, UL labeled hoses and other threads and configurations are available, contact Dixon®

Uncoupled

Size	Bowl	Length	Part #	Price/E
1½"	1-3/4"	50'	A315-50UC	\$174.80
	1-3/4"	100'	A315-100UC	349.60
2"	2-1/4"	50'	A320-50UC	296.80
	2-1/4"	100'	A320-100UC	593.55
2½"	2-13/16"	50'	A325-50UC	369.85
	2-13/16"	100'	A325-100UC	612.50
3"	3-3/8"	50'	A330-50UC	498.85
	3-3/8"	100'	A330-100UC	997.70



Coupled with female and male expansion ring couplings

Size	Length	Part #	Rocker Lug Aluminum	Rocker Lug Brass	Rocker Lug Aluminum
			<i>NST (NH)</i> RAF	<i>NST (NH)</i> RBF	<i>NPSH</i> RAS
1½"	50'	A315-50	\$266.25	\$336.80	\$266.25
	100'	A315100	460.95	530.35	460.95
2"	50'	A320-50	---	---	566.60
	100'	A320100	---	---	901.70
2½"	50'	A325-50	430.10	664.55	430.10
	100'	A325100	828.75	1001.30	828.75
3"	50'	A330-50	---	---	841.95
	100'	A330100	---	---	1365.85



500# Single Jacket All Polyester Fire Hose

Features:

- outer construction: single jacket, all polyester
- tube construction: EPDM rubber lining
- proof pressure: **500 PSI**
- service test pressure: **250 PSI** at ambient temperature **70°F (21°C)**
- working pressure: **225 PSI** at ambient temperature **70°F (21°C)**
- other threads and configurations are available, contact Dixon®

Uncoupled



Size	Bowl	Length	Part #	Price/E
1"	1-1/4"	50'	A510-50UC	\$173.65
	1-1/4"	100'	A510-100UC	330.80
1½"	1-3/4"	50'	A515-50UC	204.50
	1-3/4"	100'	A515-100UC	382.10
2½"	2-13/16"	50'	A525-50UC	369.85
	2-13/16"	100'	A525-100UC	644.80

Coupled with female and male expansion ring couplings



Size	Length	Part #	Rocker Lug Aluminum NST (NH) RAF	Rocker Lug Brass NST (NH) RBF	Rocker Lug Aluminum NPSH RAS
1"	50'	A510-50	---	---	\$287.35
	100'	A510100	---	---	484.00
1½"	25'	A515-25	\$213.80	---	213.80
	50'	A515-50	281.45	\$337.65	281.45
	75'	A515-75	382.35	---	---
	100'	A515100	462.10	525.15	462.10
2½"	25'	A525-25	353.10	---	353.10
	50'	A525-50	472.15	664.55	472.15
	75'	A525-75	542.65	---	---
	100'	A525100	828.75	1001.30	828.75



500# Single Jacket Fire Hose - UL labeled

Features:

- outer construction: single jacket, all polyester
- tube construction: EPDM rubber lining
- proof pressure: **500 PSI**
- service test pressure: **250 PSI** at ambient temperature **70°F (21°C)**
- working pressure: **225 PSI** at ambient temperature **70°F (21°C)**
- Underwriters Listed
- impregnated hose and other lengths threads and configurations are available, contact Dixon®

Coupled with female and male expansion ring couplings



Size	Coupling Type	Length	NST Thread Part #	Price/E
1½"	combo lug, brass	50'	A515U50CBF	\$378.60
2½"	combo lug, brass	50	A525U50CBF	610.00

500# Single Jacket Fire Hose - Color Impregnated

Features:

- outer construction: single jacket, all polyester
- tube construction: EPDM rubber lining
- proof pressure: **500 PSI**
- service test pressure: **250 PSI**
- working pressure: **225 PSI** at ambient temperature **70°F (21°C)**
- consult Dixon® for pricing and availability of other colors, lengths, threads and configurations

Coupled with female and male expansion ring couplings

Size	Coupling Type	Length	Color	Part #	Price/E
1½"	rocker lug, aluminum, NST (NH)	50'	yellow	A515Y50RAF	\$368.00
	rocker lug, aluminum, NPSH	50'	yellow	A515Y50RAS	368.00
	rocker lug, aluminum, NST (NH)	50'	red	A515R50RAF	368.00
	rocker lug, aluminum, NPSH	50'	red	A515R50RAS	368.00
	rocker lug, aluminum, NST (NH)	50'	orange	A515OR50RAF	368.00
	rocker lug, aluminum, NPSH	50'	orange	A515OR50RAS	368.00



orange



red

800# Double Jacket All Polyester Fire Hose

Features:

- outer construction: double jacket, all polyester
- tube construction: EPDM rubber lining
- proof pressure: **800 PSI**
- service test pressure: **400 PSI**
- working pressure: **360 PSI** at ambient temperature **70°F (21°C)**
- consult Dixon™ for pricing and availability of 75' lengths and other threads and configurations

Coupled with female and male expansion ring couplings

Size	Length	Part #	Rocker Lug Aluminum NST (NH) RAF	Rocker Lug Brass NST (NH) RBF	Rocker Lug Aluminum NPSH RAS
1½"	25'	D815-25	\$249.50	---	---
	50'	D815-50	349.90	\$390.95	\$349.90
	100'	D815100	656.70	633.35	656.70
2½"	25'	D825-25	419.95	---	---
	50'	D825-50	635.95	784.65	635.95
	100'	D825100	958.15	1232.80	958.15



800# Double Jacket Fire Hose - Impregnated

Features:

- outer construction: double jacket, all polyester
- tube construction: black, synthetic rubber liner
- proof pressure: **800 PSI** at **70°F (21°C)**
- service test pressure: **400 PSI** at **70°F (21°C)**
- working pressure: **360 PSI** at **70°F (21°C)**
- other lengths, threads and couplings and colors (yellow, red, blue, tan, orange, green, black) are available, contact Dixon®

Coupled with female & male expansion ring couplings

Size	Coupling Type	Length	Part #	Price/E
1½"	rocker lug, aluminum NST (NH)	50'	D815Y50RAF	\$413.00
	rocker lug, aluminum NST (NH)	100'	D815Y100RAF	722.70
	rocker lug, aluminum NPSH	50'	D815Y50RAS	413.00
	rocker lug, aluminum NPSH	100'	D815Y100RAS	722.70
2½"	rocker lug, aluminum NST (NH)	50'	D825Y50RAF	715.65
	rocker lug, aluminum NST (NH)	100'	D825Y100RAF	1298.95



MSHA Approved Single Jacket Mine Fire Hose



Specification:

- approved by MSHA: Mine Safety and Health Administration for all mine fire protection applications

Features:

- outer construction: single jacket, synthetic flame resistant
- tube construction: flame resistant lining
- proof pressure: **500 PSI at 70°F (21°C)**
- service test pressure: **250 PSI at 70°F (21°C)**
- working pressure: **225 PSI at 70°F (21°C)**

Coupled with female and male aluminum rocker lug expansion ring couplings

Size	Thread	Length	Part #	Price/E
1½"	NST (NH)	50'	SM515W50RAF	\$561.05
	NPSH	50'	SM515W50RAS	561.05

Double Jacket Potable Water Hose - Blue



Features:

- Liner is NSF approved for potable water, fittings are not, except for temporary / emergency drinking needs only.
- outer construction: double jacket, all polyester
- tube construction: thermoplastic
- proof pressure: **600 PSI at 70°F (21°C)**
- service test pressure: **300 PSI at 70°F (21°C)**
- working pressure: **270 PSI at 70°F (21°C)**

Coupled with female and male, brass or aluminum rocker lug, expansion ring couplings

Size	Thread	Length	Brass		Aluminum	
			Expansion Ring Part #	Price/E	Expansion Ring Part #	Price/E
1½"	NPSH	50'	PW615B50RBS	\$514.75	PW615B50RAS	\$484.00
		100'	PW615B100RBS	959.20	PW615B100RAS	859.10
	NST (NH)	50'	PW615B50RBF	514.75	PW615B50RAF	484.00
		100'	PW615B100RBF	959.20	PW615B100RAF	859.10
2½"	NPSH	50'	PW625B50RBS	1019.35	PW625B50RAS	761.75
		100'	PW625B100RBS	1647.75	PW625B100RAS	1363.10
	NST (NH)	50'	PW625B50RBF	1019.35	PW625B50RAF	761.75
		100'	PW625B100RBF	1647.75	PW625B100RAF	1363.10



500# All Polyester Rack Hose - UL Labeled



Application:

- for pin rack service / emergency fire fighting only, not to be used for washdown

Features:

- outer construction: single jacket, all polyester
- tube construction: clear thermoplastic
- proof pressure: **300 PSI at ambient temperature 70°F (21°C)**
- service test pressure: **150 PSI at ambient temperature 70°F (21°C)**
- working pressure: **135 PSI at ambient temperature 70°F (21°C)**
- Underwriters Listed

Coupled with female and male expansion ring couplings

Size	Coupling Type	Length	Folded		Coiled	
			Part #	Price/E	Part #	Price/E
1½"	combo lug, brass NST (NH)	50'	R515U50CBF/F	\$274.95	R515U50CBF	\$274.95
	combo lug, brass NST (NH)	100'	R515U100CBF/F	486.85	R515U100CBF	486.85
	combo lug, alum. NST (NH)	50'	R515U50RAF/F	258.60	R515U50RAF	258.60
	combo lug, alum. NST (NH)	100'	R515U100RAF/F	458.20	---	---

500# All Polyester Rack Hose - non-UL Labeled

Application:

- for pin rack service / emergency fire fighting only, not to be used for washdown

Features:

- outer construction: single jacket, all polyester
- tube construction: clear thermoplastic
- proof pressure: **500 PSI** at ambient temperature **70°F (21°C)**
- service test pressure: **250 PSI** at ambient temperature **70°F (21°C)**
- working pressure: **225 PSI** at ambient temperature **70°F (21°C)**

Coupled with female and male expansion ring couplings

Size	Coupling Type	Length	Folded		Coiled	
			Part #	Price/E	Part #	Price/E
1½"	combo lug, brass NST (NH)	50'	R515-50CBF/F	\$252.35	R515-50CBF	\$252.35
	combo lug, brass NST (NH)	100'	R515100CBF/F	402.35	R515100CBF	402.35
	combo lug, alum. NST (NH)	50'	R515-50RAF/F	227.90	R515-50RAF	239.30
	combo lug, alum. NST (NH)	100'	R515100RAF/F	378.00	R515100RAF	355.95



500# Nitrile Covered Fire Hose - Light Duty Red

Application:

- ideal for industrial and construction washdown and discharge applications

Features:

- outer construction: thin ribbed nitrile
- tube construction: nitrile
- proof pressure: **500 PSI** at ambient temperature **70°F (21°C)**
- service test pressure: **250 PSI** at ambient temperature **70°F (21°C)**
- working pressure: **225 PSI** at ambient temperature **70°F (21°C)**
- other colors, threads and configurations are available, consult Dixon®

Uncoupled

Size	Bowl	Length	Part #	Price/E
1½"	1-13/16"	50'	H515R50UC	\$429.70
2½"	2-13/16"	50'	H525R50UC	663.00
1½"	1-13/16"	100'	H515R100UC	781.20
2½"	2-13/16"	100'	H525R100UC	1147.25



Coupled with female and male expansion ring couplings

Size	Length	Part #	Rocker Lug	Rocker Lug	Rocker Lug
			Aluminum NST (NH) RAF	Brass NST (NH) RBF	Aluminum NPSH RAS
1½"	50'	H515R50	\$488.95	\$540.80	\$488.95
2½"	50'	H525R50	799.85	876.70	799.85
1½"	100'	H515R100	1016.65	---	1016.65
2½"	100'	H525R100	1386.00	---	---



Forestry Non Weeping Fire Hose



Features:

- outer construction: single jacket, all polyester
- tube construction: thermoplastic
- impregnation: yellow
- proof pressure: **600 PSI** at ambient temperature **70°F (21°C)**
- service test pressure: **300 PSI** at ambient temperature **70°F (21°C)**
- working pressure: **270 PSI** at ambient temperature **70°F (21°C)**
- consult Dixon® for pricing and availability of 25' lengths, other threads and configurations

Coupled with female and male expansion ring couplings

Size	Length	Part #	Rocker Lug Aluminum NST (NH)	Rocker Lug Aluminum NPSH
			RAF	RAS
1"	50'	NF610Y50	\$313.65	---
1"	100'	NF610Y100	517.20	---
1½"	50'	NF615Y50	---	\$372.85
1½"	100'	NF615Y100	---	625.00

Forestry Mop Up Hose

Application:

- used on mop-up and low volume hand lines to fill pump cans supplying sprinklers and remote fire line protection

Features:

- 50' coil diameter is 9"
- outer construction: single jacket, synthetic
- tube construction: thermoplastic
- impregnation: yellow
- proof pressure: **300 PSI** at ambient temperature **70°F (21°C)**
- service test pressure: **150 PSI** at ambient temperature **70°F (21°C)**
- working pressure: **135 PSI** at ambient temperature **70°F (21°C)**
- consult Dixon™ for pricing and availability of other threads and configurations



Coupled with female and male brass ferrule type garden hose couplings

Size	Length	Part #	Price
¾"	50'	NF307Y50GHT	\$221.25
1½"	50'	NF615-50RAQT¹	360.85
1½"	100'	NF615100RAQT¹	589.95

¹ coupled with quarter turn forestry couplings

Forestry Mop Up Hose Kit



Description	Part #	Price
kit contains: hose, pouch and nozzle	NF307Y50GHT-KIT	\$355.10

Nitrile Covered Fire Hose - Heavy Duty - Yellow

Applications:

- ideal for heavy-duty washdown in refineries and power plants

Features:

- extruded interlocking matrix fire hose with 100% synthetic circular woven polyester reinforcement
- heavy ribbed for severe service
- outer construction: thick ribbed nitrile
- tube construction: nitrile
- 25' lengths, other colors, threads and configurations are available, contact Dixon®
- Pressures supplied in the chart below are at ambient temperature **70°F (21°C)**.

Size	Proof Pressure PSI	Service Test Pressure PSI	Working Pressure PSI
1" - 3"	600	300	270
4"	450	225	200
5"	400	200	180
6"	300	150	135

Uncoupled

Size	Bowl	Length	Part #	Price/E
1"	1-1/4"	50'	H610Y50UC	\$332.20
1½"	1-13/16"	50'	H615Y50UC	499.15
2"	2-1/4"	50'	H620Y50UC	622.45
2½"	2-13/16"	50'	H625Y50UC	751.70
3"	3-3/8"	50'	H630Y50UC	844.95
4"	4-3/8"	50'	H440Y50UC	1108.85
5"	5-3/8"	50'	H450Y50UC	1111.10



Coupled with female and male expansion ring couplings

Size	Length	Part #	Rocker Lug <i>Aluminum</i> NST (NH) RAF	Rocker Lug <i>Brass</i> NST (NH) RBF	Pin Lug <i>Brass</i> NST (NH) PBF	Rocker Lug <i>Aluminum</i> NPSH RAS
1"	50'	H610Y50	\$498.30	---	---	\$498.30
1½"	50'	H615Y50	572.75	\$631.45	\$730.70	572.75
2½"	50'	H625Y50	920.10	982.20	1052.40	920.10



Coupled with female and male segmented Storz collar style couplings

Features:

- working pressures can be achieved using appropriate expansion ring couplings
- under no circumstance should the hose be used beyond the working pressure of the fittings to which it is coupled
- assembled hose should be hydrostatically proof tested before use, and thereafter in accordance with NFPA 1962



Size	Length	Storz Size	Part #	Price/E
4"	50'	4"	H440Y50SZ	\$1575.60
5"	50'	5"	H450Y50SZ	1858.25
5"	100'	5"	H450Y100SZ	3154.05



Non-collapsible Chemical Booster Hose - Red

**Features:**

- outer cover material: specially compounded red EPDM tough cover
- inner tube material: smooth black synthetic EPDM rubber
- reinforced with multiple plies of high tensile Aramid yarn providing flexible strength
- ¾" diameter hose is coupled with 1" threaded couplings
- meets and exceeds NFPA standard 1961
- working pressure: **800 PSI**

Coupled with female and male NST (NH) thread, chromed brass hole type couplings

Size	Length	Part #	Price/E
¾"	50'	80B07-50HCF	\$1191.30
	100'	80B07-100HCF	1901.50
1"	50'	80B10-50HCF	1431.85
	100'	80B10-100HCF	2348.20

Coupled with female and male NST (NH) thread, hole type coupling, aluminum expansion ring couplings

Size	Length	Part #	Price/E
¾"	50'	80B07-50HAF	\$896.25
	100'	80B07-100HAF	1701.00
1"	50'	80B10-50HAF	1096.80
	100'	80B10-100HAF	2147.75

Non-collapsible Fire and Utility Hose - Red

Features:

- outer construction is designed to withstand abrasion
- working pressure: **200 PSI** at ambient temperature **70°F (21°C)**
- burst pressure: **600 PSI** at ambient temperature **70°F (21°C)**
- consult Dixon® for pricing and availability of other lengths, threads and configurations
- also available with chrome brass fittings

Coupled with female and male NST (NH) thread, rocker lug, brass expansion ring couplings

Size	Length	Part #	Price/E
1½"	50'	15B15-50RBF	\$1173.10
	100'	15B15-100RBF	1953.70



Coupled with female and male NST (NH) thread, rocker lug, aluminum expansion ring couplings

Size	Length	Part #	Price/E
1½"	50'	15B15-50RAF	\$864.85
	100'	15B15-100RAF	1450.00



Coupled with female and male NPSH thread, rocker lug, aluminum expansion ring couplings

Size	Length	Part #	Price/E
1½"	50'	15B15-50RAS	\$864.85
	100'	15B15-100RAS	1450.00



Style V Swing Type Hose Storage Reels

Hose & Tubing

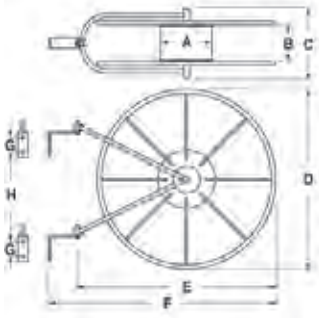

Features:

- drum storage of collapsible hose prevents damaging kinks allowing longer hose life
- pivot mounting permits reel to swing to the proper angle preventing twists and kinks
- open sides allow faster hose drying, to prevent mold and mildew
- red polyester powder coat finish
- wall mounting is standard, 2 wall mounting brackets included
- style V5 (when used with 1½" hose only), has a space between the reel sides to accommodate two widths of hose side by side, for maximum capacity in minimum space
- replacement brackets - **1212-0930-4**, 2 per set

Size	Hose Capacity			A	B	C	D	E	F	G	H	Steel	
	Rack	Single	Double									Part #	Price/E
1½" - 1¾"	100'	75'	50'	8"	3"	7½"	21"	23"	27"	2"	11⅞"	FHR-V1	\$250.00
1½" - 1¾"	150'	100'	75'	8"	3"	7½"	26"	29"	33"	2"	15"	FHR-V2	250.00
1½"	300'	200'	150'	8"	5½"	9½"	26"	30"	34"	2"	13"	FHR-V5	282.00
2" - 2½"	150'	100'	75'	8"	5½"	9½"	26"	30"	34"	2"	13"	FHR-V5	282.00

Covers for Style V Swing Type Hose Storage Reels

Features:

- Velcro™ closures
- printed on both sides



Cover for	Dimensions	Vinyl Coated Nylon	
		Part #	Price/E
FHR-V2	26"	FHR-C	\$69.60
FHR-V1	21"	FHR-C1	62.50
FHR-V5	26"	HSRC26	69.60

Swing Type Hose Storage Reels

Features:

- one piece wall bracket (14 gauge), for easier mounting
- 180° swing will also take pipe clamps to 3"
- compact size - smaller reel hub to allow more hose storage
- baked red enamel finish
- 14 gauge steel support arms
- welded construction - rim (18 gauge) hub cap, welded spokes form solid wheels, separated by a molded poly hub and bolted together to form a sturdy unit
- hose is double rolled from the center of length coupled to valve and nozzle
- hose is ready for action when completely removed and valve is open

Hose Size	Hose Capacity		Part #	Steel	Price/E
	Lightweight	Rubber Lined			
1½"	150'	50' - 75'	HSR18		\$276.95
	250'	100'	HSR24		332.50
2½"	100'	100'	HSR25-24		502.85

Dimensions

Cover for	A	B	C
HSR18	18"	23½"	6¼"
HSR24	24"	29"	6¼"
HSR25-24	24"	29"	8¼"

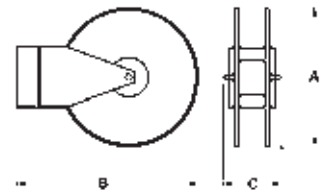

Covers for Swing Type Hose Reels

Features:

- to be used with hose storage reels, bright red fabric reinforced PVC with Velcro™ closures for quick release
- "Fire Hose / Keep Clear" printed on one side

Cover for	Dimensions	Part #	Vinyl	Price/E
HSR24	24"	HSRC24	62.75	
HSR25-24	24" - 25"	HSRC25-24	60.45	



Heavy Duty, High Capacity Swing Type Hose Storage Reel

Features:

- welded steel wall bracket swings 180°
- wall bracket adapts to pipes (1½" - 3") with an optional pipe bracket kit
- red baked enamel finish
- supplied with hook-and-loop back strap to keep hose securely wound

Size	Hose Capacity		Part #	16-gauge steel	Price/E
	Single Jacket	Double Jacket			
1½"	200'	150'	DXHDR25HC		\$1023.20
2½"	100'	75'			



Cover for Heavy Duty Swing Type Hose Storage Reel

Features:

- to be used with hose storage reels
- "Fire Hose / Keep Clear" printed on one side

Cover for	Dimensions	Part #	Vinyl	Price/E



Pipe Brackets for Heavy Duty Swing Type Hose Storage Reel

Description	Part #	Vinyl	Price/E



Global Continuous Flow Reels

Hose & Tubing

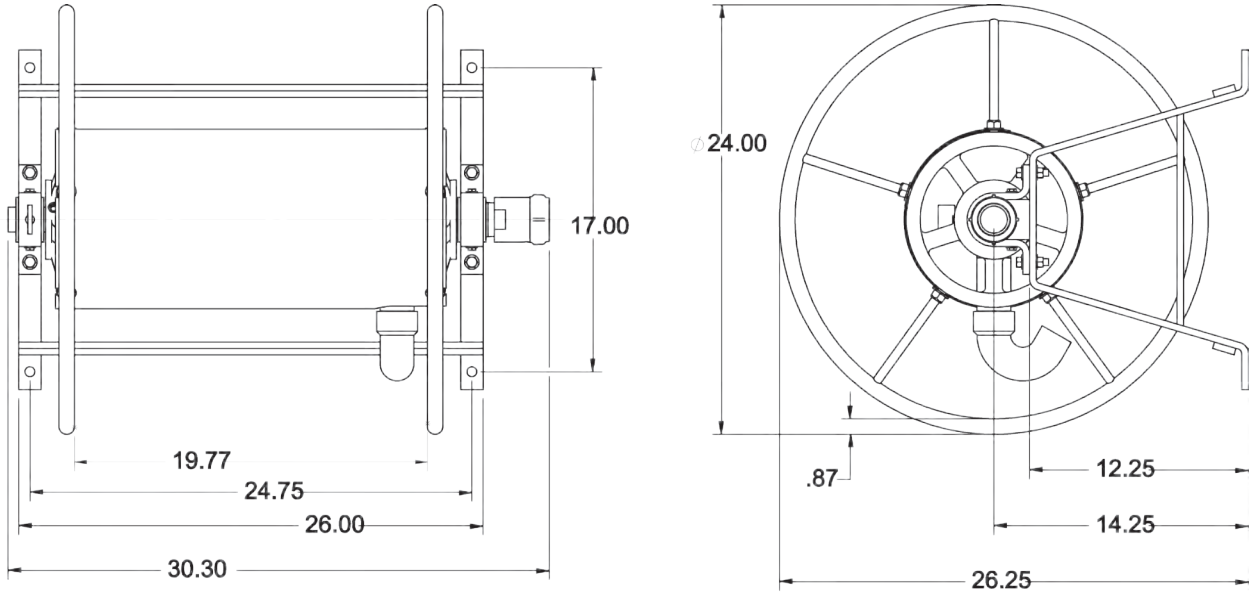

Features:

- greaseless swivel and reel bearings improve performance
- optional adapters (order separately):
 FM15S15F = 1½" FNPSH x 1½" MNST brass
 FM1515F = 1½" FNPT x 1½" MNST brass
- replacement inlet swivel joints at bottom of page



Hose Size and Capacity			Inlet Size	Outlet Size	Steel	
¾"	1"	1½"			Part #	Price/E
250'	150'	100'	1½" NPT	1½" NPT	FD47IR-150-100	\$1240.00

Cover for Global Continuous Flow Hose Reel



Cover for	Dimensions	Part #	Vinyl	Price/E
FD47IR-150-100	22" x 24" x 24"	FD47-C2		\$195.00

Replacement Inlet Swivel Joint for FD471-150-100

Features:

- ball-bearing swivel
- requires no lubrication
- **200 PSI**



Size	Cast Brass	
	Part #	Price/E
1½"	CSSF150T	\$185.40

Continuous Flow Reels

Features:

- allows immediate and continuous flow of water at all times during deployment of hose
- one-person operation
- use with non-collapsible hose shown on page K-17
- powder coated with an electrostatically-applied, thermally-fused, red polyester finish steel drum
- rims and universal mounting stand
- female NPT inlet with male NST (NH) hose thread outlet

A flexible connector assembly must be installed directly between the hose reel inlet hub and the water supply. **Failure to use the flexible connector assembly will void the warranty.** 

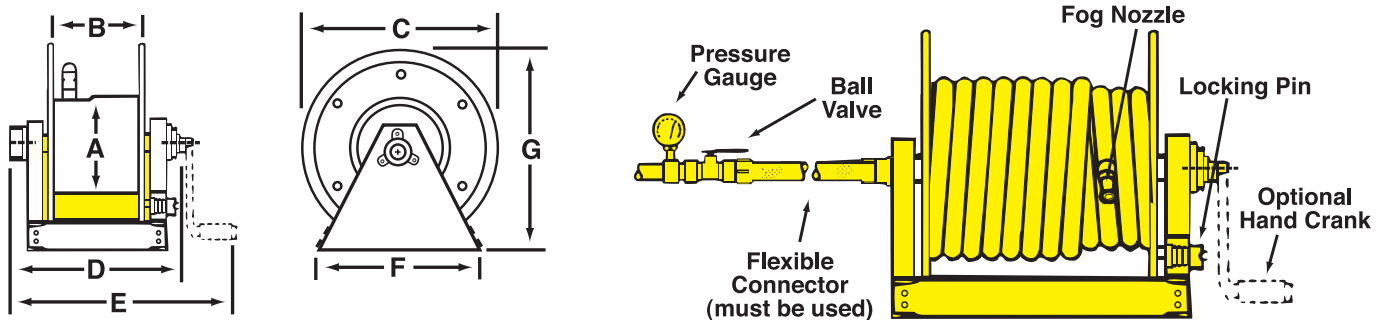

Hose Size and Capacity			A	B	C	D	E	F	G	Inlet Size	Outlet Size	Steel Part #	Price/E
3/4"	1"	1 1/2"											
150'	125'	---	10 1/2"	11 1/2"	24"	19 1/4"	24"	21 3/4"	26"	1"	1"	CFR47-1-100	\$2130.55
250'	150'	100'	10 1/2"	20 1/2"	24"	28 1/4"	33"	21 3/4"	26"	1 1/2"	1 1/2"	CFR47-150-100	2130.55
400'	300'	150'	10 1/2"	28"	24"	35 3/4"	40 1/2"	21 3/4"	26"	1 1/2"	1 1/2"	CFR47-1-200	2205.00
---	---	200'	10 1/2"	34"	24"	41 3/4"	46 1/2"	21 3/4"	26"	1 1/2"	1 1/2"	CFR47-150-200	2233.65

Optional Accessories

Description	Part #	Price/E
1" x 18" flexible connector (male NPT x male NPT)	DX2836	\$189.00
1 1/2" x 18" flexible connector (male NPT x male NPT)	DX2839	189.00
hand crank	CFR-HC	150.00
repair kit: contains O-ring, PTFE retaining ring for the inlet casting, spacer washer, and 2 steel retaining rings for the manifold	CFR-RK	128.00

Covers for Continuous Flow Hose Reels

Cover for	Dimensions H x W x D	Part #	Vinyl Price/E
CFR47-1-100	26" x 20" x 26"	CFR47-C1	\$136.90
CFR47-1-200	26" x 36" x 26"	CFR47-C2	186.45
CFR47-150-100	26" x 29" x 26"	CFR47-C3	182.00
CFR47-150-200	26" x 42" x 26"	CFR47-C4	202.80



Hump Racks

Hose & Tubing



Features:

- compact, neat and economical method of storing collapsible hose
- pivot mounting permits rack to swing, preventing kinks and twists
- rugged steel construction provides long, dependable service
- red enamel finish for protection
- open sides allow faster drying to prevent mold and mildew
- wall mounting brackets are standard

Hose Size	Hose Capacity			Steel	
	Synthetic	Single Jacket	Double Jacket	Part #	Price/E
1½" - 1¾"	100'	50'	---	FHHR-1	\$220.00
1½" - 1¾"	150'	100'	50'	FHHR-3	321.25
2" - 2½"	100'	50'	---	FHHR-2	220.00
2" - 2½"	150'	100'	50'	FHHR-4	327.30
1½" - 1¾"	200'	150'	100'	FHHR-5	340.65

Covers for Hump Racks



Cover for	Dimensions	Vinyl	
		Part #	Price/E
FHHR-1 or FHHR-2	16" x 25½" x 6"	FHHR-C	\$118.90
FHHR-3 or FHHR-4	24" x 29½" x 6"	FHHR-C4	139.30
FHHR-5	33½" x 35½" x 6"	FHHR-C5	148.15

Hose Racks

Features:

- can be used for fire or water hose
- constructed from 12 gauge sheet steel
- provides compact and economical hose storage
- curved saddle design avoids sharp bends in the hose prolonging hose life
- red enamel finish



Hose Size	Rack	Hose Capacity		Steel	
		Single Jacket	Double Jacket	Part #	Price/E
1½" - 1¾"	50'	---	---	HR1610-3	\$110.65
1½" - 1¾"	100'	---	---	HR1610-6	130.15
1½" - 2½"	200'	150'	100'	HR1610	162.80
2" - 2½"	50'	---	---	HR1610-4	119.45

Hung Up On Dixon® Hose Racks



single hose rack

Application:

- used to store fire or water hose

Features:

- 5 pre-drilled 5/16" mounting holes for easy mounting
- two racks can be bolted face to face to create extra hose capacity



double hose rack
(hose not included)

Description	Dimensions	Aluminum	
		Part #	Price/E
single hose rack	19-1/2" x 6" x 9-3/16"	DHR1	\$222.30
double hose rack	19-1/2" x 12" x 9-3/16"	DHR2	460.00

Pin Rack Hose Assembly



Features:

- components include: rack nipple, UL **300 PSI** angle valve, semi-automatic fire hose pin rack, brass rack nozzle, and a length of 1½" pin rack hose
- UL listed and Factory Mutual approved
- per NFPA 1962, Chap. 4, in-service hose shall be un-racked and physically inspected at least annually



Hose & Tubing

NST (NH) Thread	Hose	Part #	Price/E
1½"	50'	FHPR150-50CBF	\$973.65
	75'	FHPR150-75CBF	1071.00
	100'	FHPR150-100CBF	1088.20

Semi Automatic Fire Hose Pin Racks

Features:

- red steel enameled
- holds up to 100' of either 1½" or 2½" rack hose
- 1½" is UL listed and Factory Mutual approved



Hose Size	For use with:		Part #	Steel	Price/E
	Valve	Nipple			
1½"	AVF150	PRN150F	FHPR150		\$151.50
2½"	AVF250	PRN250F	FHPR2515		183.30

Covers for Pin Racks

Features:

- 10 oz. red vinyl with Velcro™ closures
- used on FHPR150, FHPR150-50CBF, FHPR150-75CBF, FHPR150-100CBF



Size	Part #	Vinyl	Price/E

Pin Rack Nipples

Feature:

- finish: -C polished chrome plated

Male NPT	Male NST (NH)	Part #	Brass	Price/E
2½"	2½"	PRN250F		120.55



Pin Rack Wall Bracket

Application:

- used to support hose rack independent of a stand pipe valve



Part #	Aluminum	Price/E
PRWB		\$107.25



Steel Hose Cabinet



Hose & Tubing



Features:

- red polyester coated finish on 18-gauge steel
- designed for wall installation, with or without legs, or free standing
- supplied with holes in the back for wall mounting and 1" pipe couplings on the bottom for adding legs
- Factory Mutual approved
- hose, accessories and mounting hardware not included
- furnished without legs, if legs required contact Dixon®

Steel Part #	Price/E
HC30143	\$2319.55

Dimensions

width	depth	height
60"	15"	48"

Basic Approved Equipment for Hose Cabinet

Examples				Quantity Required		
Part #	Price/E	Description	Page #	Factory Mutual	UL & FIA	ISO
A525-50RAF ¹	\$472.15	2½" x 50' single jacket hose	L-10	4	5	5
A515-50RAF ¹	281.45	1½" x 50' single jacket hose	L-10	2	0	0
UPP250F ¹	718.35	Underwriters play pipe	K-24	0	2	2
BFN250NST ¹	309.00	2½" adjustable fog nozzle	K-11	2	0	0
BFN150NST ¹	144.75	1½" adjustable fog nozzle	K-11	1	0	0
HA2515F ¹	29.70	2½" x 1½" pin lug adapter	J-84	1	0	0
233	43.20	universal spanner	J-113	4	5	5
189	38.70	adjustable hydrant wrench	J-114	2	2	2
PHFA6	220.00	6 lb. fire axe	M-11	0	1	1
FCB48	142.35	crowbar	---	0	1	1
SW150 ¹	2.00	1½" hose coupling gasket	E-71, J-99	4	5	5
SW250 ¹	3.25	2½" hose coupling gasket	E-71, J-106, J-99	2	0	0

¹ threads must be appropriate to the authority having jurisdiction



Reelcraft® 5000 Series Spring Driven Hose Reels

Features:

- reel inlet $\frac{3}{8}$ " NPTF
- all steel construction
- full shaft and swivel
- supplied standard with PVC hose
- maximum temperature: **150°F (66°C)**
- Compressed air hose should not be converted to oxygen service; they are often contaminated with an oil coating, which can react explosively when oxygen is introduced.



with hose

Hose ID	Hose Length	Service	Working Pressure PSI	Part #	Price/E
$\frac{1}{4}$ "	50'	air / water	300	5450LP	\$765.00
$\frac{3}{8}$ "	35'	air / water	300	5635LP	726.75
	50'	air / water	300	5650LP	878.00

without hose

Hose Capacity	Service	Working Pressure PSI	Part #	Price/E
50' of $\frac{1}{4}$ " or 35' of $\frac{3}{8}$ "	air / water	500	5600LP	\$625.00
50' of $\frac{3}{8}$ "	air / water	500	5605LP	730.00

Reelcraft® 7000 Series

Features:

- all steel construction
- LP Low Pressure reels:
 - maximum temperature **150°F (66°C)**
 - reel inlet $\frac{1}{2}$ " NPTF
 - PVC hose is standard
- MP Medium Pressure reels:
 - maximum temperature **210°F (99°C)**
 - reel inlet $\frac{1}{2}$ " NPTF
 - SAE 100 R1T 1-wire braid hose available
- HP High Pressure reels:
 - maximum temperature **210°F (99°C)**
 - reel inlet $\frac{1}{4}$ " NPTF
 - SAE 100 R2T 2-wire braid hose available

with hose

Hose ID	Hose Length	Service	Working Pressure PSI	Part #	Price/E
$\frac{3}{8}$ "	70'	air / water	300	7670LP	\$1158.80
$\frac{1}{2}$ "	50'	air / water	300	7850LP	1132.50

without hose

Hose Capacity	Service	Working Pressure PSI	Part #	Price/E
70' of $\frac{3}{8}$ ", 50' of $\frac{1}{2}$ "	air / water	500	7800LP	\$911.00
50' of $\frac{3}{8}$ " or 50' of $\frac{1}{2}$ "	oil	3000	7800MP	1060.00
50' of $\frac{1}{4}$ " or 50' of $\frac{3}{8}$ "	grease	5000	7600HP	1224.50



Reelcraft® 80000 Series

Hose & Tubing



see below for bumper stops, consult Dixon® for uses other than stated services

Features:

- reel inlet ¾" NPTF
- five-in-one heat treated aluminum casting incorporates main shaft, ratchet, spring arbor and inlet/outlet plumbing in one-piece casting
- furnished standard with PVC hose
- maximum temperature is **150°F (66°C) with hose**
- maximum temperature is **210°F (99°C) without hose**

with hose

Hose ID	Hose Length	Service	Working Pressure PSI	Part #	Price/E
½"	75'	air / water	300	82075LP	\$1738.00
	100'	air / water	300	82100LP	1804.50
¾"	50'	air / water	250	83050LP	1738.00

without hose

Hose Capacity	Service	PSI	Part #	Price/E
50' of ¾" or 100' of ½"	air / water	500	83000LP	\$1530.00

Adjustable Hose Bumper Stops

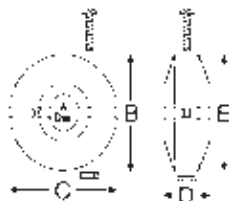

Hose ID	Hose OD		Dimensions		Reel Series Used On	Part #	Price/E
	From:	To:	B,C,E	D			
¼"	.438"	.625"	2½"	1¼"	5000 series	1-HR1004A	\$31.00
⅜"	.625"	.749"	2½"	1¼"	5000 series	1-HR1004	31.00
⅜"	.625"	.749"	3"	1¼"	7000 series	1-HR1004-3	31.00
½" or ⅜" 2-wire	.750"	1.050"	3"	1¼"	7000 series	2-HR1004-3	31.00
¾"	1.060"	1.300"	3"	1¼"	7000 series	3-HR1004-3	31.00
½"	.750"	1.050"	3½"	2⅞"	9000 series	2-HR1005	72.00
¾"	1.060"	1.380"	3½"	2⅞"	9000 series	3-HR1005	72.00
1"	1.390"	1.550"	3½"	2⅞"	9000 series	4-HR1005	72.00

- not included on hose reels ordered without hose, must order separately

Reelcraft® 30,000 Manual Driven Hose Reels



Features:

- reel frame, spool and drum are fabricated from heavy gauge steel
- all bolted construction - no welds
- manual driven standard
- motor drive available
- ½" inlet

without hose

Hose ID	Hose Capacity	Spool Width	Working Pressure PSI	Part #	Price/E
¾"	100'	12"	1000	C33112L	\$814.50
½"	200'	12"	3000	C32112M	701.00



Contractors EPDM Water Hose

Features:

- heavy duty, crush proof solid brass couplings with wrench grips
- spiral synthetic cord reinforcement
- black cover
- working pressure: **150 PSI**
- temperature range: **-20°F to 180°F (-29°C to 82°C)**



Hose & Tubing

Size	EPDM		Optional Qty
	Part #	Price/E	
¾" x 50'	CWH50	\$186.00	3

Rubber Vinyl Garden Hose

Features:

- extra tough, five-ply construction
- exclusive, soft textured, abrasion-resistant green cover
- dual reinforced, heavy-duty, flexibility, kink resistance
- combines durability of rubber, easy handling of vinyl
- SEAL-TITE® leakproof coupling
- working pressure: **150 PSI**
- temperature range: **0°F to 140°F (-18°C to 60°C)**



Size	Rubber Vinyl		Optional Qty
	Part #	Price/E	
⅝" x 25'	SGH25	\$51.50	5
⅝" x 50'	SGH50	89.00	5
⅝" x 75'	SGH75	121.00	3
⅝" x 100'	SGH100	168.00	3

Premium EPDM Hose

Features:

- professional grade reinforcement provides maximum strength
- heavy-duty flexibility
- ultimate kink resistance
- SEAL-TITE® leakproof coupling
- black cover
- working pressure: **125 PSI**
- temperature range: **-20°F to 160°F (-29°C to 71°C)**



Size	EPDM		Optional Qty
	Part #	Price/E	
⅝" x 50'	PGH50	\$121.00	5
⅝" x 100'	PGH100	244.00	3

Flexogen® Hose

Features:

- heavy-duty, crush resistant, full-flow brass couplings with a built-in washer for tight sealing
- coils and handles easily in all weather
- lightweight patented 8-ply construction
- maximum kink resistance
- flow guard plus protective collar resists kinks at faucet
- polished surface resists abrasions, stains and mildew
- grey cover



Size	Flexogen®		Price/E
	Part #		
⅝" x 25'	FGH25		\$55.70
⅝" x 50'	FGH50		94.30

Perfect Water Hose



Features

- for residential and industrial use
- lightweight, easy handling
- heavy duty male and female garden hose fittings
- blue cover
- polypropylene double helix construction with TPE cover
- flexible and kink-free
- working pressure: **100 PSI at 70°F (21°C)**
- burst pressure: **300 PSI at 70°F (21°C)**
- temperature range: **-20°F to 158°F (-29°C to 70°C)**

Size	Part #	Price/E
5/8" x 25'	PWH25	\$84.00
5/8" x 50'	PWH50	155.00
5/8" x 100'	PWH100	288.00

Premium Flexzilla® Garden Hose



Features:

- temperature range: **-40°F to 150°F (-40°C to 66°C)**
- anodized aircraft aluminum fittings 3/4" - 1 1/2" GHT fittings on both ends of hose
- kink resistant under pressure
- no memory - lays flat, coils easily
- abrasion resistant
- rugged bend restrictors
- lightweight
- lime green cover

Size	Part #	Hybrid Polymer	Price/E
5/8" x 50'	KRH50		\$133.00
5/8" x 75'	KRH75		196.00
5/8" x 100'	KRH100		252.00

Top Level PVC Hose



Features:

- heavy-duty 3/4" brass couplings
- kink resistant
- green cover
- working pressure: **100 PSI**
- temperature range: **15°F to 150°F (-9°C to 66°C)**

Size	Part #	PVC	Price/E
5/8" x 50'	GGH50		\$53.50
5/8" x 75'	GGH75		70.00

Hot Water Rubber Reinforced Hose



Features:

- industrial style reinforcing for flexibility, high burst strength
- extra heavy-duty, crush-proof, machined brass couplings
- maximum wear, abrasion-resistant red cover
- withstands extensive hot water up to **200°F (93°C)**
- working pressure: **130 PSI**

Size	Part #	Rubber	Price/E	Optional Qty
5/8" x 50'	HWH50		\$138.00	5
3/4" x 50'	HWH50-75		204.00	3



Marine, Camper, Patio & Pool Hose

Features:

- lightweight to handle, easy to store
- USFDA - approved tube materials for food contact use
- nickel plated couplings
- white cover
- working pressure: **80 PSI** at ambient temperature **70°F (21°C)**



Hose & Tubing

Size	Part #	Price/E	Optional Qty
5/8" x 50'	MCH50	\$77.00	5

Country Club® RT Hose

Features:

- for golf courses, parks, nurseries
- premium PVC for high strength, flexibility
- lightweight, easy handling
- industrial knit reinforcing for kink resistance
- heavy duty 1" NPSH brass couplings
- green cover
- working pressure: **150 PSI** at ambient temperature **70°F (21°C)**
- burst pressure: **450 PSI**



Size	Part #	Price/E	Optional Qty
1" x 50'	CCH50	\$316.70	2



PVC Tubing

Applications:

- for use with standard shank fittings in low pressure liquid and pneumatic applications

domestic**Features:**

- for non-critical hospital use such as suction and draining
- made from non-toxic ingredients conforming to FDA and 3A standards
- shipped in individually boxed bundles, *sold only in lengths shown below*
- maximum temperature: **175°F (79°C)**



Size		Working Pressure PSI @ 72°F (22°C)	Length	Clear PVC	
OD	ID			Part #	Price/Length
5/16"	3/16"	55	100'	CL0305	\$46.00
3/8"	1/4"	55	100'	CL0406	62.75
1/2"	1/4"	70	100'	CL0408	117.00
7/16"	5/16"	50	100'	CL0507	63.75
1/2"	3/8"	40	100'	CL0608	72.25
5/8"	3/8"	65	100'	CL0610	153.00
5/8"	1/2"	30	100'	CL0810	101.00
3/4"	1/2"	45	100'	CL0812	184.00
7/8"	5/8"	40	100'	CL1014	250.00
1"	3/4"	35	100'	CL1216	258.00
1-1/4"	1"	28	100'	CL1620	340.00
1-3/4"	1-1/4"	45	50'	CL2028-50	520.00
2"	1-1/2"	40	50'	CL2432-50	545.00

imported**Features:**

- temperature range: **14°F to 149°F (-10°C to 65°C)**
- shipped in bundles wrapped with PVC film, *sold only in lengths shown below*



Size		Working Pressure PSI @ 72°F (22°C)	Length	Clear PVC	
OD	ID			Part #	Price/Length
3/8"	1/4"	50	100'	ICL0406	\$25.50
1/2"	3/8"	35	100'	ICL0608	35.45
5/8"	1/2"	35	100'	ICL0810	46.30
3/4"	1/2"	50	100'	ICL0812	100.90
1"	3/4"	35	100'	ICL1216	143.50
1 1/4"	1"	30	100'	ICL1620	178.55
2"	1 1/2"	15	50'	ICL2432	290.55

PVC Braided Tubing

Applications:

- for use with standard shank fittings in low pressure liquid and pneumatic applications

domestic

Features:

- high grade tensile strength polyester yarn reinforcement
- temperature range: **27°F to 150°F (-3C to 66°C)**
- shipped in coils, *sold only in lengths shown below*

Size		Working Pressure PSI @ 72°F (22°C)	Length	Clear PVC	
OD	ID			Part #	Price/Length
.394	3/16"	315	300'	BR0306	\$300.00
.435	1/4"	315	300'	BR0446	360.00
.625	3/8"	265	300'	BR0609	651.50
.728	1/2"	215	300'	BR0812	560.00
.906	5/8"	200	300'	BR1014	830.00
1.024	3/4"	150	300'	BR1218	820.00
1.732	1-1/4"	110	100'	BR2027	890.00
1.950	1-1/2"	90	100'	BR2431	1775.00



imported

Features:

- for various machine tools and the transportation of chemicals
- temperature range: **14°F to 149°F (-10°C to 65°C)**
- shipped in bundles wrapped with PVC film, *sold only in lengths shown below*

Size		Working Pressure PSI @ 72°F (22°C)	Length	Clear PVC	
OD	ID			Part #	Price/Length
1/2"	1/4"	142	300'	IBR0446	\$191.00
5/8"	3/8"	114	300'	IBR0609	246.25
3/4"	1/2"	100	300'	IBR0812	310.00
1-1/16"	3/4"	71	300'	IBR1218	661.30
1-5/16"	1"	71	200'	IBR1621	513.10



D.O.T. Air Brake Tubing Rolls

Features:

- meets Department of Transportation FMVSS-106 nylon material conforming to SAE J844
- working pressure: **150 PSI**
- temperature range: **-40°F to 200°F (-40°C to 93°C)**
- tubing cutters sold on page K-36

Tube Size	Tubing Color	Length	Nylon	
			Part #	Price/E
3/16"	black	100'	J844-03-BL-100	\$78.00
1/4"	black	100'	J844-04-BL-100	99.00
	blue	100'	J844-04-B-100	99.00
	red	100'	J844-04-R-100	99.00
3/8"	black	100'	J844-06-BL-100	258.40
	blue	100'	J844-06-B-100	258.40
	red	100'	J844-06-R-100	258.40
1/2"	black	100'	J844-08-BL-100	352.00
5/8"	black	100'	J844-10-BL-100	596.40
3/4"	black	100'	J844-12-BL-100	885.00



Polyurethane Tubing

Features:

- naturally transparent
- temperature range: **-40°F to 165°F (-40°C to 74°C)**
- for use with the push-in fittings sold on pages F-143 to F-151
- excellent memory, flexibility and resistance to kinking
- good resistance to fuels and oils
- low gas and vapor permeability
- high compressive strength
- low compressive set and extractability levels
- outstanding abrasion resistance



Size		Wall Thickness	Working Pressure PSI @ 75°F (24°C)	Length	Polyurethane	
OD	ID				Part #	Price/Length
1/8"	.062"	.0295"	255	250'	04063	\$47.75
5/32"	.094"	.0315"	210	100'	05094	33.75
1/4"	.160"	.0450"	175	100'	08160	62.50
3/8"	.245"	.0650"	170	100'	12250	117.50
1/2"	.320"	.0900"	175	50'	16320	157.00

Polyethylene Tubing

Features:

- designed for FDA applications, complies with 21CFR 177.1520 (c) food contact
- temperature range: **-50°F to 140°F (-46° to 60°C)**
- for use with the push-in fittings sold on pages F-143 to F-151
- flexible, lightweight, low-density polyethylene (LLDPE) tubing
- for use with plastic or metal inserts with outer sleeve; ferrule or clamps
- formulated to resist stress cracking



Size		Wall Thickness	Working Pressure PSI @ 75°F (24°C)	Length	Tubing Color	Polyethylene	
OD	ID					Part #	Price/Length
1/4"	.125"	.062"	350	100'	natural	0804	\$14.80
1/4"	.170"	.040"	150	100'	natural	0817	13.40
1/4"	.170"	.040"	150	100'	blue	0817BL100	17.30
3/8"	.250"	.062"	150	100'	natural	1208	28.25
1/2"	.375"	.062"	125	100'	natural	1612	37.10

Size		Wall Thickness	Working Pressure PSI @ 75°F (24°C)	Length	Tubing Color	Polyethylene	
OD	ID					Part #	Price/Length
1/4"	.170"	.040"	150	500'	blue	0817BL	\$67.00
1/4"	.170"	.040"	150	500'	black	0817BR	67.00
1/4"	.170"	.040"	150	500'	natural	0817CR	67.00
3/8"	.250"	.062"	150	500'	black	1208BR	120.00
3/8"	.250"	.062"	150	500'	natural	1208CR	120.00

Nylon Tubing

Features:

- naturally transparent
- temperature range: **-40°F to 180°F (-40°C to 82°C)**
- for use with the push-in fittings sold on pages F-143 to F-151
- recommended for applications requiring low density, lightweight toughness, flexibility and chemical resistance
- packaged in plastic bags



Size		Wall Thickness	Working Pressure PSI @ 75°F (24°C)	Length	Nylon	
OD	ID				Part #	Price/Length
1/8"	.093"	.016"	270	100'	04093	\$31.50
5/32"	.106"	.025"	350	100'	05106	39.50
3/16"	.138"	.025"	260	100'	06138	50.00
1/4"	.170"	.040"	330	100'	08170	84.00
1/4"	.180"	.035"	290	100'	08180	80.00
3/8"	.275"	.050"	250	100'	12275	170.00
1/2"	.375"	.062"	240	100'	16375	256.75

Tubing cutters sold on page K-36

Legris Nylon Tubing

Application:

- ideal for many industrial applications

Features:

- chemical, humidity and abrasive resistant
- semi rigid
- temperature range: **-65°F to 200°F (-54°C to 93°C)**



Size		Wall Thickness	Working Pressure PSI @ 75°F (24°C)	Length	Natural Nylon		Black Nylon		Blue Nylon	
OD	ID				Part #	Price/Lgth	Part #	Price/Lgth	Part #	Price/Lgth
1/8"	.093"	.016"	250	50'	1091P5300	\$33.65	1091P5301	\$33.45	1091P5304	\$34.50
5/32"	.106"	.025"	300	50'	1091P0400	32.00	1091P0401	30.00	1091P0404	30.00
3/16"	.138"	.025"	250	50'	1091P5500	53.20	1091P5501	53.55	---	---
1/4"	.170"	.040"	300	50'	1091P5600	60.30	1091P5601	64.05	1091P5604	57.75
5/16"	.233"	.040"	250	50'	1091P0800	83.75	1091P0801	87.00	1091P0804	87.00
3/8"	.275"	.050"	250	50'	1091P6000	119.90	1091P6001	118.00	1091P6004	113.90
1/2"	.375"	.062"	250	50'	1091P6200	196.00	1091P6201	186.00	1091P6204	188.10

Size		Wall Thickness	Working Pressure PSI @ 75°F (24°C)	Length	Natural Nylon		Black Nylon		Blue Nylon	
OD	ID				Part #	Price/Lgth	Part #	Price/Lgth	Part #	Price/Lgth
1/8"	.093"	.016"	250	100'	1094P5300	\$59.25	1094P5301	\$59.25	1094P5304	\$59.25
5/32"	.106"	.025"	300	100'	1094P0400	60.75	1094P0401	55.80	1094P0404	66.15
3/16"	.138"	.025"	250	100'	1094P5500	98.85	1094P5501	98.85	---	---
1/4"	.170"	.040"	300	100'	1094P5600	113.15	1094P5601	114.90	1094P5604	103.60
5/16"	.233"	.040"	250	100'	1094P0800	151.85	1094P0801	154.55	1094P0804	153.00
3/8"	.275"	.050"	250	100'	1094P6000	215.70	1094P6001	218.25	1094P6004	209.20
1/2"	.375"	.062"	250	100'	1094P6200	352.25	1094P6201	358.15	1094P6204	350.45

Polyurethane - 95 Durometer Tubing

Application:

- good for applications where space is tight; for applications where tubing will be exposed, black tubing is recommended

Features:

- high flexibility and a small bend radius
- temperature range: **-40°F to 165°F (-40°C to 74°C)**



Size		Wall Thickness	Working Pressure PSI @ 75°F (24°C)	Length	Clear Polyurethane		Black Polyurethane		Blue Polyurethane	
OD	ID				Part #	Price/Lgth	Part #	Price/Lgth	Part #	Price/Lgth
1/8"	.062"	.031"	233	50'	1091U53R00	\$25.25	1091U5301	\$24.65	1091U5304	\$25.30
5/32"	.093"	.031"	176	50'	1091U04R00	34.70	1091U0401	30.55	1091U0404	31.35
1/4"	.160"	.045"	148	50'	1091U56R00	54.50	1091U5601	58.80	1091U5604	57.10
5/16"	.216"	.049"	148	50'	1091U08R00	83.50	1091U0801	77.05	1091U0804	81.35
3/8"	.250"	.066"	147	50'	1091U60R00	102.00	1091U6001	110.30	1091U6004	104.10
1/2"	.320"	.090"	140	50'	1091U62R00	198.45	1091U6201	200.10	1091U6204	206.00

Size		Wall Thickness	Working Pressure PSI @ 75°F (24°C)	Length	Clear Polyurethane		Black Polyurethane		Blue Polyurethane	
OD	ID				Part #	Price/Lgth	Part #	Price/Lgth	Part #	Price/Lgth
1/8"	.062"	.031"	233	100'	1094U53R00	\$45.10	1094U5301	\$44.40	1094U5304	\$47.40
5/32"	.093"	.031"	176	100'	1094U04R00	58.60	1094U0401	56.50	1094U0404	58.85
1/4"	.160"	.045"	148	100'	1094U56R00	98.15	1094U5601	103.50	1094U5604	96.40
5/16"	.216"	.049"	148	100'	1094U08R00	156.00	1094U0801	143.75	1094U0804	157.75
3/8"	.250"	.066"	147	100'	1094U60R00	190.20	1094U6001	197.85	1094U6004	194.60
1/2"	.320"	.090"	140	100'	1094U62R00	355.05	1094U6201	354.00	1094U6204	372.00

Fluoropolymer FEP 140 Tubing

Features:

- FDA compliant materials
- provides excellent resistance to aggressive and corrosive agents and high temperatures
- maximum temperature: **300°F (149°C)**

Size		Wall Thickness	Working Pressure PSI @ 72°F (22°C)	Length	Clear Fluoropolymer	
OD	ID				Part #	Price/Lgth
1/8"	.062"	.031"	500	25'	1092T5300	\$79.95
1/4"	.170"	.031"	165	25'	1092T5600	177.35
3/8"	.300"	.062"	249	25'	1092T6000	194.55
1/2"	.420"	.062"	165	25'	1092T6200	386.85



Coil-Chief Self-Storing Air Hose
fittings included

Hose & Tubing



Feature:

- supplied with swivel on one end

Hose ID	Length	Male NPT	Working Pressure @ 70°F (21°C)	Nylon	
				Part #	Price/E
1/4"	12'	1/4"	185	CC1412	\$35.80
	25'	1/4"	185	CC1425	52.50
	50'	1/4"	185	CC1450	88.40
3/8"	25'	3/8"	165	CC3825	89.00
	50'	3/8"	165	CC3850	153.00
1/2"	25'	1/2"	170	CC1225	176.00
	50'	1/2"	170	CC1250	268.00

bulk hose - no fittings

Feature:

- needs assembly kits for ends



Hose ID	Length	Nylon	
		Part #	Price/E
1/4"	100'	CC14100B	\$137.00
3/8"	100'	CC38100B	266.00
1/2"	100'	CC12100B	440.00

Assembly Kits

Feature:

- kits include fittings, nut, insert, ferrule and spring guard



RK110 assembly kit

Size	Fitting Type	Part #	Price/E
1/4"	rigid male	RK090	\$7.50
1/4"	swivel male	RK092	10.10
3/8"	rigid male	RK110	10.70
3/8"	swivel male	RK112	14.40
1/2"	rigid male	RK118	23.60
1/2"	swivel male	RK119	30.00



Polyurethane Self-Storing Air Hose
fittings included

Features:

- extremely flexible - resists kinking
- impervious to abrasions, heat and oil
- superior elasticity and coil memory
- both ends swivel

Hose ID	Length	Male NPT	Working Pressure (PSI)	Polyurethane	
				Part #	Price/E
1/4"	10'	1/4"	145	PU1410	\$51.00
	15'	1/4"	145	PU1415	56.50
	25'	1/4"	145	PU1425	63.50
3/8"	15'	3/8"	135	PU3815	90.00
	20'	3/8"	135	PU3820	101.00
	25'	3/8"	135	PU3825	113.00
	50'	3/8"	135	PU3850	214.00
1/2"	15'	1/2"	155	PU1215	154.00



Repair Kits

Size	Tubing Size		Type	Brass	
	ID	OD		Part #	Price/E
1/4"	1/4"	3/8"	swivel male	PSM0404	\$11.60
	3/8"	9/16"	swivel male	PSM0604	15.90



Polyurethane Air Hose
fittings included

Features:

- durable and lightweight
- nylon-reinforced braid allows for higher working pressure
- excellent flexibility
- oil resistant
- durometer: Shore A 85
- temperature range: -40°F to 155°F (-40°C to 68°C)
- working pressure: 210 PSI at 70°F (21°C)

Hose ID	Length	Male NPT	Polyurethane	
			Part #	Price/E
1/4"	50'	1/4"	450-4S	\$81.50
3/8"	50'	1/4"	650-4S	157.00
	50'	3/8"	650-6S	161.00



PVC Tubing and Hose Cutters

Hose & Tubing



Features:

- rugged construction cuts up to 3/4" tubing or hose
- corrosion resistant hardened steel blade ensures straight, crisp cuts for optimum fit

Part #	Price/E
TC97	\$17.00
TC97RB	5.85



Features:

- cuts low pressure fabric reinforced hose up to 1" OD
- reversible blade

Part #	Price/E
HC90	\$26.70
HC90RB (replacement blade)	11.15



Features:

- cuts hose and tubing up to 1 7/8" OD
- tough fiberglass reinforced handle
- stainless steel blade

Part #	Price/E
LHC95	\$47.70
LHC95RB (replacement blade)	19.00



Nominal

Application:

- suitable for conveying chemicals, foods, pharmaceuticals, oils, gas, fuels and steam

Features:

- nominal standard smooth bore PTFE hose meets SAE100R14
- size range: dash-3 to dash-20
- temperature range: **-100°F to 450°F (-73°C to 232°C)**
- 304 stainless braided
- extruded or heat shrink coverings are available upon request
- boxed coils (bulk, per ft. lengths and full reels available from Maryland and Texas call Dixon® at 888.226.4673)
- for use with PTFE fittings on pages H-77 through H-79

Nominal Smooth Bore PTFE Hose*(fittings not included)*

Nominal Size	Average ID	Length in Feet	Dash Size	Working Pressure	Burst Pressure	White, non-conductive		Black, conductive	
						Part #	Price/E	Part #	Price/E
3/16"	.125"	100'	dash-3	3000 PSI	12000	---	---	BSB-03-100	\$711.00
1/4"	.187"	100'	dash-4	3000 PSI	12000	WSB-04-100	\$576.00	BSB-04-100	634.50
5/16"	.250"	100'	dash-5	3000 PSI	12000	WSB-05-100	670.40	BSB-05-100	678.15
3/8"	.312"	100'	dash-6	2500 PSI	10000	WSB-06-100	753.05	BSB-06-100	814.50
3/8T"	.375"	100'	dash-6T	2250 PSI	9000	WSB-06T-100	958.50	BSB-06T-100	1057.50
1/2"	.405"	100'	dash-8	2000 PSI	8000	WSB-08-100	855.00	BSB-08-100	940.50
5/8"	.500"	100'	dash-10	1750 PSI	7000	WSB-10-100	1125.00	BSB-10-100	1237.50
3/4"	.625"	100'	dash-12	1500 PSI	6000	WSB-12-100	1424.75	BSB-12-100	1417.00
3/4T"	.750"	50'	dash-12T	1100 PSI	4400	WSB-12T-50	974.25	BSB-12T-50	1073.25
1"	.875"	50'	dash-16	1000 PSI	4000	WSB-16-50	1067.40	BSB-16-50	1511.25

Nominal Smooth Bore PTFE Hose Per Foot Length*(fittings not included)*

Nominal Size	Average ID	Dash Size	White, non-conductive		Black, conductive	
			Part #	Price/E	Part #	Price/E
3/16"	.125"	dash-3	WSB-03	\$6.10	BSB-03	\$7.15
1/4"	.187"	dash-4	WSB-04	5.80	BSB-04	6.35
5/16"	.250"	dash-5	WSB-05	6.55	BSB-05	6.50
3/8"	.312"	dash-6	WSB-06	7.45	BSB-06	8.15
3/8T"	.375"	dash-6T	WSB-06T	9.60	BSB-06T	10.60
1/2"	.405"	dash-8	WSB-08	8.55	BSB-08	9.45
5/8"	.500"	dash-10	WSB-10	11.25	BSB-10	12.40
3/4"	.625"	dash-12	WSB-12	14.10	BSB-12	13.95
3/4T"	.750"	dash-12T	WSB-12T	20.00	BSB-12T	21.50
1"	.875"	dash-16	WSB-16	21.35	BSB-16	29.45
1T"	1.000"	dash-16T	WSB-16T	29.55	BSB-16T	32.55
1-1/4"	1.125"	dash-20Z	WSB-20Z¹	63.00	BSB-20Z¹	75.80

¹ double braided

- per feet lengths are available from Maryland and Texas only, call Dixon® at 888.226.4673

True ID Hose

Hose & Tubing



(WOC)
PTFE convoluted
non-conductive



(BOC)
PTFE convoluted
conductive

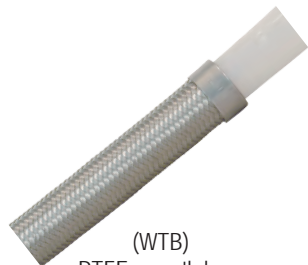

(WTB)
PTFE smooth bore
non-conductive

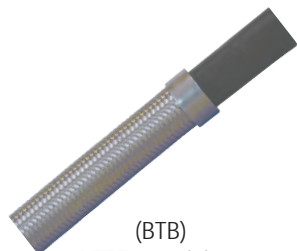

(BTB)
PTFE smooth bore
conductive

Applications:

- suitable for conveying acids, chemicals, foods and pharmaceuticals

Features:

- size range: ¼" to 2"
- temperature range: -100°F to 450°F (-73°C to 232°C)
- boxed coils (bulk, per ft. lengths and full reels available from Maryland and Texas, call Dixon® at 888.226.4673)
- 304 stainless braided
- other braids including synthetic, extruded and heat shrink coverings are available upon request
- for use with PTFE fittings on pages H-77 through H-79

True ID Open Pitch Convoluted Hose
(fittings not included)

Size	Working Pressure PSI	Burst Pressure PSI	White, non-conductive		Black, conductive	
			Part #	Price/Ft	Part #	Price/Ft
¼"	1740	6960	WOC-T04	\$21.45	BOC-T04	\$27.75
⅜"	1850	7400	WOC-T06	21.45	BOC-T06	27.75
½"	1500	6000	WOC-T08	24.10	BOC-T08	26.45
¾"	1300	5200	WOC-T12	28.20	BOC-T12	31.50
1"	1000	4000	WOC-T16	45.70	BOC-T16	49.85
1¼"	900	3600	WOC-T20	54.85	BOC-T20	71.00
1½"	700	2800	WOC-T24	71.10	BOC-T24	78.30
2"	500	2000	WOC-T32	90.65	BOC-T32	99.85

Heavy Wall True ID Smooth Bore Hose
(fittings not included)

Size	Working Pressure PSI	Burst Pressure PSI	White, non-conductive		Black, conductive	
			Part #	Price/Ft	Part #	Price/Ft
¼"	3000	12000	WTB-T04	\$10.40	BTB-T04	\$11.80
⅜"	2250	9000	WTB-T06	14.25	BTB-T06	15.75
½"	1500	6000	WTB-T08	17.75	BTB-T08	19.50
¾"	1100	4400	WTB-T12	29.50	BTB-T12	32.40
1"	900	3600	WTB-T16	39.60	BTB-T16	43.55
1"	1650	6600	WTB-T16Z	63.80	BTB-T16Z	75.65
1¼"	1000	4000	WTB-T20Z	79.95	BTB-T20Z	105.50
1½"	1100	4000	WTB-T24Z	185.50	BTB-T24Z	155.35



Spiral Hose and Cable Protection

Applications:

- used in mining, quarrying, forestry, offshore industries and most hydraulic hose applications

Features:

- crush and high abrasion resistance
- chemical and UV ray resistant
- self-lubricating to reduce hose wear
- easy to install on-site
- smooth radius on all edges
- can be used on single or multiple hose bundles
- spiral guard ID is equal to the guard at rest
- sold in coil lengths only

Flame Retardant Product

Features:

- approved by MSHA #1C-264/0
- tested to: AS 2600, AS1180.10B, AS 1180.13A
- flame retardant, self extinguishing, anti static
- temperature range: **-148°F to 262°F (-100°C to 100°C)**
- color: black

Nominal ID	Coil Length	OD Range (inches)	Part #	Price/E
0.45"	66'	.47" to .86"	<i>FRSGX16</i>	\$229.00
0.55"	66'	.62" to 1.06"	<i>FRSGX20</i>	296.00
0.80"	66'	.86" to 1.37"	<i>FRSGX25</i>	372.00
1.00"	66'	1.06" to 1.69"	<i>FRSGX32</i>	659.95
1.26"	66'	1.30" to 2.17"	<i>FRSGX40</i>	848.00
1.50"	66'	1.65" to 2.52"	<i>FRSGX50</i>	1184.75
2.00"	66'	2.05" to 2.95"	<i>FRSGX63</i>	1540.00
2.40"	66'	2.56" to 3.80"	<i>FRSGX75</i>	2012.00
2.83"	66'	3.15" to 4.30"	<i>FRSGX90</i>	2362.00
3.43"	33'	3.80" to 4.90"	<i>FRSGX110</i>	1563.00



Standard Product

Features:

- not flame retardant
- temperature range: **-40°F to 248°F (-50°C to 90°C)**

Nominal ID	Coil Length	OD Range (inches)	Part #	Price/E
0.45"	66'	.47" to .86"	<i>NFSGX16</i>	\$102.50
0.55"	66'	.62" to 1.06"	<i>NFSGX20</i>	142.90
0.80"	66'	.86" to 1.37"	<i>NFSGX25</i>	197.20
1.00"	66'	1.06" to 1.69"	<i>NFSGX32</i>	282.60
1.26"	66'	1.30" to 2.17"	<i>NFSGX40</i>	419.25
1.50"	66'	1.65" to 2.52"	<i>NFSGX50</i>	549.70
2.00"	66'	2.05" to 2.95"	<i>NFSGX63</i>	754.65
2.40"	66'	2.56" to 3.80"	<i>NFSGX75</i>	1080.70
2.83"	66'	3.15" to 4.30"	<i>NFSGX90</i>	1397.50
3.43"	33'	3.80" to 4.90"	<i>NFSGX110</i>	832.30



Fiberglass Sleeving

Hose & Tubing

Features:

- thermal insulation protection in applications with service temperatures up to **1000°F (538°C)**
- supplied in a continuous length of 100'
- 1/16" wall thickness
- braided from texturized E-glass filament yarns, untreated tubing is flexible and expands to cover changing diameters.



Nominal ID	Fiberglass	
	Part #	Price/E
¼"	LW04200	\$81.25
⅜"	LW06200	81.25
½"	LW08200	127.50
⅝"	LW10200	129.50
¾"	LW12200	139.00
⅞"	LW14200	156.40
1"	LW16200	214.50
1¼"	LW20200	220.25
1½"	LW24200	318.70
2"	LW32200	371.00
2½"	LW40200	399.75
3"	LW48200	434.60
3½"	LW56200	521.50
4"	LW64200	539.00



Kevlar® Protective Sleeves

Features:

- braided cut-resistant sleeve made of 100% genuine Kevlar® fibers provides excellent flexibility
- provides protection for hydraulic hoses full lines, wires, cables and many other systems
- working temperature: continuous **320°F (160°C)**, short term **570°F (300°C)**
- 3000 denier ballistic grade Kevlar®, nonirritating fiber



Sleeve ID	100' spool	
	Part #	Price/E
½" (13 mm)	KS08200	\$484.85
¾" (19 mm)	KS12200	552.75
1" (25 mm)	KS16200	761.25
1¼" (32 mm)	KS20200	877.60
1½" (38 mm)	KS24200	1042.45
1¾" (44 mm)	KS28200	1202.45
2" (51 mm)	KS32200	1391.55
2½" (64 mm)	KS40200	1604.85
3" (76 mm)	KS48200	1905.45
3½" (89 mm)	KS56200	2792.75
4" (102 mm)	KS64200	3219.40

Nylon Protective Sleeves - MSHA Accepted

Features:

- woven tubular sleeving, for use as a protective covering on hydraulic and industrial hose
- tight weave of seamless tubular sleeving helps dispense the flow of fluid in a ruptured hose
- MSHA accepted, withstands temperatures up to **275°F (135°C)**, passes flammability tests
- not continuous rolls/has splices

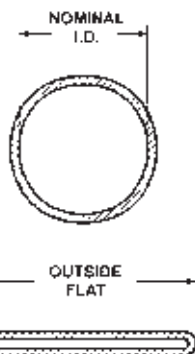

Nominal ID	Outside Flat	100' rolls		300' rolls	
		Part #	Price/E	Part #	Price/E
0.90"	1.50"	DHS90-100	\$142.35	DHS90-300	\$388.20
1.00"	1.66"	DHS100-100	152.90	DHS100-300	417.00
1.13"	1.88"	DHS106-100	164.10	DHS106-300	447.40
1.25"	2.13"	DHS122-100	186.95	DHS122-300	509.85
1.46"	2.25"	DHS138-100	212.95	DHS138-300	580.70
1.42"	2.50"	DHS142-100	218.35	DHS142-300	595.45
1.58"	2.75"	DHS159-1-100	226.10	DHS159-1-300	616.55
1.78"	2.88"	DHS175-100	248.25	DHS175-300	677.00
1.91"	3.00"	DHS181-100	262.00	DHS181-300	714.50
2.18"	3.63"	DHS219-100	330.60	DHS219-300	901.70
2.38"	3.88"	DHS238-100	392.55	DHS238-300	1070.45
2.65"	4.25"	DHS263-100	418.55	DHS263-300	1141.50
2.86"	4.75"	DHS288-100	461.15	DHS288-300	1257.65
3.65"	5.88"	DHS366-100	550.05	DHS366-300	1500.00

Fire Jacket for Hose

Application:

- used to protect hose and hose assemblies, tubing, piping, wiring and cables from high temperatures, direct flame or molten splash

Features:

- helps maintain line temperature and reduce environmental overheating and overcooling
- meets flammability requirements of UL 94 HB & UL 94 V-0
- sleeving slides easily over hose & expands to go over fittings
- resistant to hydraulic fluids and lubricating oil
- iron oxide red color
- compounded silicone rubber coating over fiberglass
- completely non-asbestos, REACH - ROHS compliant
- supplied in 50' lengths
- temperature range: **-65°F to 500°F (-54°C to 260°C)**

Nominal ID	Part #	Price/E
1/4"	0610-4	\$185.40
3/8"	1010-6	220.25
1/2"	1310-8	243.50
5/8"	1610-10	278.10
3/4"	1910-12	310.00
7/8"	2210-14	371.00
1"	2510-16	394.00
1 1/4"	3210-20	475.20
1 1/2"	3810-24	539.00
1 3/4"	4510-28	660.50
2"	5110-32	776.25
2 1/2"	6410-40	959.50
3"	7610-48	1393.60
4"	10210-64	1718.20



Fire Jacket Tape

Application:

- used to seal the ends of fire jackets to prevent fraying and fluid wicking

Features:

- completely non-asbestos
- iron oxide red color
- temperature range: **-45°F to 380°F (-45°C to 200°C)**

Size	Length	<i>Silicone Rubber</i> Part #	Price/E
1"	12 yards	FTH100	\$52.50



Non Adhesive Fire Tape

Features:

- fiberglass coated silicone rubber
- fluid resistant to hydraulic fluids and lubricating oils
- should be installed in a spiral wrap utilizing 30% to 50% overlap
- iron oxide red color
- temperature range: **-65°F to 500°F (-54°C to 260°C)**

Width	Length	<i>Fiberglass Coated Silicone Rubber</i> Part #	Price/E
3"	50'	4055-3	\$660.50



Spring Guard

Hose & Tubing

Features:

- protects hose against the effects of flexing at its most vulnerable point - immediately behind the coupling
- optional end tang allows end guard to be secured under a clamp or ferrule
- wire fits most hose OD's from ½" to 3¼", contact Dixon® for custom sizes or lengths

with tang

Guard ID	Wire Gauge	Overall Length	Tang Length	Approx. # of Coils/Ft.	Galvanized Steel		304 Stainless Steel	
					Part #	Price/E	Part #	Price/E
¾"	0.175	12"	1"	33	SEGC1-0.75-12	\$14.00	SEGS1-0.75-12	\$18.00
1"	0.175	12"	1"	33	SEGC1-1.00-12	16.00	SEGS1-1.00-12	24.00
1¼"	0.175	14"	2"	39	SEGC1-1.25-14	17.00	SEGS1-1.25-14	26.00
1½"	0.175	14"	2"	39	SEGC1-1.50-14	18.00	SEGS1-1.50-14	27.00
1¾"	0.175	16"	2"	44	SEGC1-1.75-16	21.00	SEGS1-1.75-16	31.00
2"	0.280	16"	2"	44	SEGC1-2.00-16	24.00	SEGS1-2.00-16	32.00
2½"	0.280	18"	2"	50	SEGC1-2.50-18	25.00	SEGS1-2.50-18	40.00
3"	0.280	18"	2"	50	SEGC1-3.00-18	30.00	SEGS1-3.00-18	42.00

without tang

Guard ID	Wire Gauge	Overall Length	Tang Length	Approx. # of Coils/Ft.	Galvanized Steel		304 Stainless Steel	
					Part #	Price/E	Part #	Price/E
¾"	0.175	12"	1"	33	SEGC0-0.75-12	\$11.00	SEGS0-0.75-12	\$17.00
1"	0.175	12"	1"	33	SEGC0-1.00-12	12.00	SEGS0-1.00-12	20.00
1¼"	0.175	14"	2"	39	SEGC0-1.25-14	13.00	SEGS0-1.25-14	21.00
1½"	0.175	14"	2"	39	SEGC0-1.50-14	14.00	SEGS0-1.50-14	23.00
1¾"	0.175	16"	2"	44	SEGC0-1.75-16	18.00	SEGS0-1.75-16	27.00
2"	0.280	16"	2"	44	SEGC0-2.00-16	21.00	SEGS0-2.00-16	28.00
2½"	0.280	18"	2"	50	SEGC0-2.50-18	22.00	SEGS0-2.50-18	36.00
3"	0.280	18"	2"	50	SEGC0-3.00-18	27.00	SEGS0-3.00-18	38.00

Continuous Spring Guard

Features:

- protects hose from external abrasion and helps resist over flexing
- fits tight to hose reducing the potential for snagging
- contact Dixon™ for custom lengths or sizes

Guard ID	Wire Gauge	Overall Length	Approx. # of Coils/Ft.	Galvanized Steel		304 Stainless Steel	
				Part #	Price/E	Part #	Price/E
¾"	0.175"	25'	33'	CWG-C-0.75-25	\$98.00	CWG-S-0.75-25	\$380.25
1"	0.175"	25'	33'	CWG-C-1.00-25	168.25	CWG-S-1.00-25	433.25
1¼"	0.175"	25'	33'	CWG-C-1.25-25	168.25	CWG-S-1.25-25	433.25
1½"	0.175"	25'	33'	CWG-C-1.50-25	230.50	CWG-S-1.50-25	526.00
1¾"	0.175"	25'	33'	CWG-C-1.75-25	230.50	CWG-S-1.75-25	526.00
2"	0.280"	25'	33'	CWG-C-2.00-25	327.25	CWG-S-2.00-25	628.00
2½"	0.280"	25'	33'	CWG-C-2.50-25	420.00	CWG-S-2.50-25	720.75
3"	0.280"	25'	33'	CWG-C-3.00-25	522.00	CWG-S-3.00-25	804.25



Thread Tape & Sealant.....	M-2 to M-3	Wrenches	M-15 to M-16
PTFE tape	M-2	Micrometer adjustable torque wrenches.....	M-15
American made (Purple).....	M-2	C series.....	M-15
Industrial (White).....	M-2	Heavy duty industrial.....	M-15
Stainless steel (Gray).....	M-2	Electronic torque wrench.....	M-15
Industrial heavy duty (Pink).....	M-2	Torque and angle meter pro	M-16
For LP gas (Yellow)	M-2	Torque and angle meters.....	M-16
Thread sealant paste.....	M-3	Torque meters.....	M-16
Joint sealant gasket material.....	M-3		
Leak detector.....	M-3		
Coupling Inserters	M-4		
Coupling inserter for large hose	M-4		
Coupling inserter for 5 ton ram.....	M-4		
Testing Equipment.....	M-5 to M-7		
Hand hydrotest pump	M-5		
Hydrostatic test pumps.....	M-6		
Hydrostatic test pump accessories.....	M-6		
Sprinkler system gauges (UM-393).....	M-7		
Line test gauges	M-7		
Three way gauge valve	M-7		
PITOT gauge	M-7		
Sprinkler line tester.....	M-7		
Accessories	M-8 to M-11		
Dixon® coupling lubricant	M-8		
WD-40 smart straw	M-8		
Spill kits	M-8		
Dixon® soft hose mallet.....	M-9		
Dixon® hose knife	M-9		
Diameter tape	M-9		
Screw pitch gauge	M-9		
Safety tag	M-10		
Safety tape	M-10		
Stretch straps	M-11		
Pick head fire axe	M-11		
Grease Whip Fittings	M-12 to M-13		
Grease whip hose assemblies.....	M-12		
Grease whip hose fittings.....	M-12		
Grease whip fittings - Zerk.....	M-13		
Oxy-Acetylene Fittings	M-14		
Oxy-acetylene hose couplings.....	M-14		
Oxy-acetylene connecting spuds.....	M-14		
Oxy-acetylene adapters.....	M-14		
Oxy-acetylene ferrules.....	M-14		



American Made PTFE Tape (Purple)

Features:

- thickness: 3.5 mil (0.0035 mm)
- temperature range: **-450°F to 500°F (-268°C to 260°C)**
- superior quality
- not for use in oxygen applications 



Size	Length	Part #	Price/E
1/2"	520"	TTPM50-520	\$5.20
	700"	TTPM50-700	5.80
	1429"	TTPM50-1429	10.30
3/4"	520"	TTPM75-520	7.00
	700"	TTPM75-700	7.60
	1429"	TTPM75-1429	13.70
1"	520"	TTPM100-520	8.50
	700"	TTPM100-700	9.70
	1429"	TTPM100-1429	17.60

Industrial PTFE Tape (White)

Features:

- thickness: 3.5 mil (0.0035 mm)
- temperature range: **-212°F to 500°F (-136°C to 260C)**



Size	Length	Part #	Price/E	Optional Qty
1/2"	260"	TTA50	\$0.90	500
	520"	TTB50	1.75	500
	1296"	TTC50	4.50	500
3/4"	260"	TTA75	1.45	350
	520"	TTB75	2.70	350
1"	520"	TTB100	2.85	250

Stainless Steel PTFE Tape (Gray)

Features:

- thickness: 4 mil
- temperature range: **-450°F to 550°F (-268°C to 288°C)**
- useful on stainless steel threaded joints or connections
- PTFE with nickel added, nickel acts like a ball bearing
- made in the US



Size	Length	Part #	Price/E	Optional Qty
1/2"	260"	TTA50SS	\$15.70	10

Industrial Heavy Duty PTFE Tape (Pink)

Features:

- thickness: 4 mil
- temperature range: **-400°F to 500°F (-240°C to 260°C)**



Size	Length	Part #	Price/E	Optional Qty
1/2"	540"	TTBP50	\$7.50	500

PTFE Tape for LP Gas (Yellow)

Features:

- thickness: 4 mil
- maximum temperature: **500°F (260°C)**
- Underwriters Listed 



Size	Length	Part #	Price/E	Optional Qty
1/2"	260"	TTA50LP	\$4.95	500

Thread Sealant Paste

Features:

- temperature range: **-300°F to 500°F (-184°C to 260°C)**
- do not use with oxygen

Size	Part #	Price/E	Optional Qty
¼ pint	LCTS14	\$14.75	24
½ pint	LCTS1	21.55	24
1 pint	LCTS2	33.75	12
1 quart	LCTS3	60.35	12



Maintenance & Repair

Joint Sealant Gasket Material

Features:

- GORE-TEX® interchangeable
- Form-In-Place expanded PTFE gasket material with adhesive backing
- manufactured from 100% virgin PTFE
- unaffected by all common chemicals (pH from 0-14)
- unlimited shelf life
- resilient with low cold flow
- requires less force than standard gasket materials
- pressure range: **vacuum to 3000 PSI**
- temperature range: **-450°F to 600°F (-268°C to 316°C)**
- made in the USA
- FDA compliant #21CFR177.1550
- larger spools are available, consult Dixon® for price and availability

Size	Length	Part #	Price/E
¼"	20'	LCJS4-20	\$69.45
¼"	50'	LCJS4-50	159.55
⅜"	25'	LCJS6-25	127.50
½"	15'	LCJS8-15	127.50
¾"	15'	LCJS12-15	291.85



Leak Detector

Features:

- detects leaks by forming bubbles which remain for up to ten minutes
- will not cause corrosion or deterioration
- color: fluorescent yellow
- non-toxic, non-freezing
- temperature range: **-7°F to 180°F (-20°C to 82°C)**
- meets Federal specification MIL-L-25567-C

Size	Part #	Price/E	Case Qty
8 oz.	LCLD	\$11.90	24



Coupling Inserter for Large Hose

Features:

- inserts 4", 5", 6", 8", 10" and 12" couplings
- includes CI96AH pump (shown below)
- portable
- coupling inserter pusher plates (not shown) must be purchased separately



Part #	Price/E
CI9	\$5820.00

Hose ID	Part #	Price/E
4" - 5"	45CIPUSH	\$300.00
6" - 8"	68CIPUSH	380.00
10" - 12"	1012CIPUSH	530.25

Coupling Inserters



CI96

Application:

- for insertion of hose shanks into hose with a 2¾" to 7¼" OD

Description	Part #	Price/E
inserter with 10,000 PSI hand pump and 5 ton ram	CI96	\$6580.00
inserter with 10,000 PSI air/hydraulic pump and 5 ton ram	CI96AH	7850.00
small jaws for 1" to 3" OD hose	CI9311SML	189.00



CI96AH



Hand Hydrotest Pump

Applications:

- designed for use in testing pipe lines, pressure tanks and pressure vessels

Features:

- uses check valves which are more efficient and longer lasting than poppet systems
- cylinder displacement: 1.37 cu. in.
- **0 -1000 PSI** pressure gauge, 10' high pressure hose and quick disconnect coupler included
- piston: 7/8" with 2" stroke
- stainless steel piston
- working pressure: **1000 PSI at 70°F (21°C)**

NPT Inlet	NPT Outlet	Aluminum	
		Part #	Price/E
1/2"	1/2"	HHTP	\$1805.75



Maintenance & Repair

Hydrostatic Test Pumps

Electric Test Pump

Features:

- 1.3 GPM hose fill rate (.28 GPM @ 2000 PSI)
- test pressure: **200 to 2000 PSI**
- suction strainer keeps dirt out of pump
- high pressure test gauge
- 115v motor
- 2' power cord
- easy to use, portable

Part #	Price/E
ETP	\$4600.00



Pneumatic Test Pump

Features:

- 5.5 GPM fill rate
- test pressure: **0 to 1500 PSI**
- stainless interior
- air gauge for quick, easy adjustment of maximum test pressure
- high pressure test gauge
- filter/regulator for clean, dry air to ensure long life of unit
- on - off valve for air input
- 15' of hose included
- easy to use, portable
- use of coalescing filter and water filter recommended for prolonged pump life

Part #	Price/E
PTP	\$6450.00



Hydrostatic Test Pump Accessories

Features:

- cost effective, pre-assembled caps or plugs allow quick set up for testing hoses
- caps and plugs equipped with ½" brass straight-through plug for quick attachment to the intermediate hose on the test pump (Pneumatic Test Pump) and bleed-off valve

cam & groove test caps for male adapters



Size	Iron / Steel		Price/E
	Part #		
1"	ID100TC		\$236.65
1½"	ID150TC		375.15
2"	ID200TC		196.50
3"	ID300TC		350.00
4"	ID400TC		536.00

cam & groove test plugs for female couplers



Size	Iron / Steel		Price/E
	Part #		
1"	IA100TP		\$150.00
1½"	IA150TP		175.00
2"	IA200TP		175.00
3"	IA300TP		380.00
4"	IA400TP		410.00

female NPT test caps



Size	Iron / Steel		Price/E
	Part #		
1"	NPT100TC		\$135.00
1½"	NPT150TC		170.00
2"	NPT200TC		200.00
3"	NPT300TC		350.00
4"	NPT400TC		410.00

male NPT test plugs



Size	Iron / Steel		Price/E
	Part #		
1"	100TP		\$220.00
1½"	150TP		250.00
2"	200TP		240.00
3"	300TP		300.25
4"	400TP		405.00

bleed-off valve



Part #	Price/E
IBV50BOV	\$89.80

FRL Attachment Accessories

Description	Part #	Price/E
⅜" Wilkerson modular coalescing filter (automatic drain)	M16-03A	\$305.35
⅜" Wilkerson modular coalescing filter (manual drain)	M16-03M	245.00
modular sleeve needed to connect M16-03A or M16-03M	GPA-95-292	17.55

Sprinkler System Gauge (UL-393)



Features:

- specifically designed for the fire sprinkler industry
- Bourdon tube pressure gauges with black polycarbonate case
- snap-in clear polycarbonate window, 4" face
- white aluminum dial with stop pin, black and red markings
- black aluminum non-adjustable pointer
- ¼" NPT lower mount
- ASME B40.1 Grade B (+ 3/2/3% accuracy)
- U/L Listed (U/L-393) and Factory Mutual Approved for fire sprinkler service
- temperature range: -40°F to 140°F (-40°C to 60°C)



Maintenance & Repair

Type	Part #	Price/E
water (0-300 PSI)	SWG300-4	\$38.40

Line Test Gauges

Features:

- rocker lug swivel
- used for testing static or flowing pressures in hoses or nozzles
- supplied with **0-300 PSI** glycerine filled 3½" diameter gauge
- freeze proof to -40°F (-40°C)
- other sizes and threads are also available, contact Dixon®



NST (NH) Thread	Hardcoated Aluminum	
	Part #	Price/E
1½"	ALTG150F	\$446.30
2½"	ALTG250F	330.00

Three Way Gauge Valve

Features:

- permits checking or replacing a gauge without shutting down the whole line
- disc: rubber



NPT Thread	Working Pressure (PSI)	Brass	
		Part #	Price/E
¼"	175	TWGV25	\$22.10

PITOT Gauge

Features:

- liquid filled gauge 0-160 PSI is standard, other pressures available, contact Dixon®
- supplied with handle grip, case and fire stream/friction loss data



Part #	Price/E
PG8083	\$536.80

Sprinkler Line Tester



Feature:

- installs on the last sprinkler head on system branch lines and controls water flow for flushing or testing the system



Inlet	Outlet	Brass	
		Part #	Price/E
1" female NPT	1" male NPSH	SLT10050	\$112.75

Dixon® Coupling Lubricant



Application:

- For use in assembly operations involving natural or synthetic rubber or plastic. Also an excellent lubricant when rubber or plastic needs to be cut, machined, pressed, turned, trimmed or ground.

Features:

- biodegradable lubricant for coupling shanks, O-rings, hoses, sleeves, rubber washers and grommets
- once coupling lubricant dries, slipping action goes away

Size	Part #	Price/E
1 liter	DCL20	\$36.50
4 liters	DCL80	94.50

WD-40 Smart Straw



Features:

- permanently attached straw
- flip up for a precision spray; flip down for regular spray action
- sold in case quantities only
- should not be used as a lubricant for coupling shanks 

Size	Part #	Price/E	Case Qty
11 oz.	WD40	\$21.00	12

Spill Kits



oil spill kit



universal spill kit

Features:

- easily stored behind a seat or in a storage compartment allowing drivers to act quickly when responding to a spill
- poly-zip bag and bucket kits feature:
 - 10 pads (15" x 19")
 - 3 socks (3" x 4')
 - 2 disposal bags with ties
 - 1 pair nitrile gloves

Description	Part #	Price/E
oil only, in 6½ gallon pail	DSK5-O	\$122.10
universal, in 6½ gallon pail	DSK5-U	118.40
oil only, in clear poly bag with zipper	DSKB-O	85.10
universal, in clear poly bag with zipper	DSKB-U	80.15



Dixon® Soft Hose Mallet

Features:

- soft mallet for pounding metal objects without damaging them
- The head material will not crack and is firmly attached to strong shaft-handle.
- length: 23"
- weight: 10 lbs.



Maintenance & Repair

Part #	Price/E
DCM1	\$375.00

Dixon® Hose Knife

Features:

- for fast cutting of rubber hose and belting
- guard protects hand while cutting



Part #	Price/E
DRK15	\$24.35

Diameter Tape

Features:

- 6' tape for quickly finding the outside diameter of any cylindrical object
- converts circumference to OD at the measured point
- ABS case



Part #	Price/E
DDT1	\$18.25

Screw Pitch Gauge

Features:

- used to determine threads per inch
- 30 leaves



Part #	<i>Stainless Steel</i>	Price/E
TPG		\$224.25



Safety Tag



Features:

- Dixon® strongly recommends the use of a safety tag or warning label on all hose assemblies.
- sold in quantities of 100 only



Length	Width	Part #	Price/E
5"	2 ³ / ₈ "	DWL100	\$0.40



WARNING!!

- worn-out hose fittings should be replaced
- loose clamps on hose can be dangerous
- bolt type clamps should be retensioned regularly
- for extra safety, retaining devices such as clips, chains or cables must be used

Safety Tape



Features:

- Dixon® strongly recommends the use of a safety tag or warning label on all hose assemblies.
- length of tape - 55 yards, approximately 255 warnings



Length	Part #	Price/E
1 ¹ / ₂ "	DSTW	\$22.00



WARNING!!

- worn-out hose fittings should be replaced
- loose clamps on hose can be dangerous
- bolt type clamps should be retensioned regularly
- for extra safety, retaining devices such as clips, chains or cables must be used



Stretch Straps

Features:

- durable tie down straps
- made of EPDM
- length does not include S-hooks
- S-hooks are steel

Length	Part #	Price/E
10"	SSE10	\$3.00
15"	SSE15	3.80
21"	SSE21	4.40
31"	SSE31	5.20
41"	SSE41	6.25

**WARNING!!**

Failure to comply with this warning may result in serious damage and/or personal injury.

Maximum end to end safe stretch = 150% of length

- do not exceed maximum safe stretch
- inspect before each use, do not use if strap is cut, cracked or abraded
- inspect hooks for damage and/or wear. Replace if needed.
- protect strap from sharp edges or heat.
- wear eye protection during use
- do not use this product as the primary tie down
- refer to federal or state regulations for proper tie down methods



Maintenance
& Repair

Pick Head Fire Axe

Features:

- red trim
- 36" hickory handle
- listed in the minimum requirements approval guides for outfitting hose houses and hose cabinets by insurance underwriters

Description	Part #	Price/E
6 lb. axe	PHFA6	\$220.00
axe brackets	PHFA-B-A	59.10



Grease Whip Hose Assemblies

Features:

- for use with hand grease guns only
- one piece crimp couplings
- 1/8"-27 male NPT thread, solid base
- US manufactured 3/16" ID hose - exceeds SAE 100R1-AT
- add "S" to order strain relief spring option
- working pressure: **3000 PSI**



Assembly Length	Previous Part #	Part #	Brass	
			Price/E	Price/E Strain Relief Spring Option
8"	GWH-0800	GWH0800	\$12.63	\$20.68
12"	---	GWH1200	14.66	20.05
		GWH1200R ¹	19.40	---
18"	---	GWH1800	17.91	23.32
		GWH1800R ¹	23.08	---
24"	GWH-2400	GWH2400	21.55	26.46
36"	GWH-3600	GWH3600	28.80	35.44
48"	GWH-4800	GWH4800	39.46	48.65
60"	GWH-6000	GWH6000	44.81	63.83

¹ retail packaging

Grease Whip Hose Fittings

Features:

- **001-0055**, **001-0260** and **001-0860** are designed to be crimped to 3/16" ID hose
- **GWH-C** and **GWHC-FF** mate with Zerk fittings on the coupler side

grease hose couplers



Description	Zinc Plated Steel				Optional Qty
	Previous Part #	Part	Price/E	Price/ Retail Pk	
1/8"-27 female NPT thread, grease hose coupler with ball check - valved shutoff	GWH-C	GWHC	\$8.15	\$10.31	25
1/8"-27 female NPT thread, full flow grease hose coupler	---	GWHC-FF	8.15	10.31	25

Add 'R' suffix to part number for retail pack option

male NPT thread - chamfered base

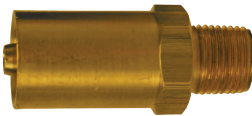

Description	Brass			Optional Qty
	Previous Part #	Part #	Price/E	
1/8"-27 male NPT thread, drilled and chamfered base	001-0055	0010055C	\$3.30	100

male NPT thread - solid base



Description	Brass			Optional Qty
	Previous Part #	Part #	Price/E	
1/8"-27 male NPT thread, solid base	001-0260	0010260C	\$2.70	100

female NPT thread



Description	Brass			Optional Qty
	Previous Part #	Part #	Price/E	
1/8"-27 female NPT thread	001-0860	0010860C	\$6.16	100

Grease Whip Fittings - Zerk

straight

Thread	Description	Overall Length	Thread Length	Hex	Zinc Plated Steel		Pkg Qty
					Part #	Price/E	
1/8"-27 NPT	straight	.660"	.260"	.430	GWHZ000	\$0.81	100
1/4"-28 tapered SAE-LT	straight	.530"	.200"	.312	GWHZ400	0.63	100



Maintenance & Repair

45°

Thread	Description	Overall Length	Thread Length	Hex	Zinc Plated Steel		Pkg Qty
					Part #	Price/E	
1/8"-27 NPT	45°	.860"	.280"	.430	GWHZ045	\$1.11	100
1/4"-28 tapered SAE-LT	45°	.800"	.200"	.375	GWHZ445	1.13	100



90°

Thread	Description	Overall Length	Thread Length	Hex	Zinc Plated Steel		Pkg Qty
					Part #	Price/E	
1/8"-27 NPT	90°	.830"	.310"	.430	GWHZ090	\$1.12	100
1/4"-28 tapered SAE-LT	90°	1.20"	.200"	.375	GWHZ490	1.13	100



Grease Whip Fittings - Zerk Retail Packaged

All items sold in retail packets of 10: Order 1 for 1 Retail Pack of 10 pieces.

straight

Thread	Description	Overall Length	Thread Length	Hex	Zinc Plated Steel	
					Part #	Price/ Retail Pk
1/8"-27 NPT	straight	.660"	.260"	.430	GWHZ000R	\$10.54
1/4"-28 tapered SAE-LT	straight	.530"	.200"	.312	GWHZ400R	8.72



45°

Thread	Description	Overall Length	Thread Length	Hex	Zinc Plated Steel	
					Part #	Price/ Retail Pk
1/8"-27 NPT	45°	.860"	.280"	.430	GWHZ045R	\$13.36
1/4"-28 tapered SAE-LT	45°	.800"	.200"	.375	GWHZ445R	13.52



90°

Thread	Description	Overall Length	Thread Length	Hex	Zinc Plated Steel	
					Part #	Price/ Retail Pk
1/8"-27 NPT	90°	.830"	.310"	.430	GWHZ090R	\$13.44
1/4"-28 tapered SAE-LT	90°	1.20"	.200"	.375	GWHZ490R	13.52



Oxy-Acetylene Hose Couplings

acetylene couplings

left-hand thread for acetylene line x hose shank



Hose Size	Left UNF Thread	Hex	Previous Part #	Brass	
				Part #	Price/E
3/16"	3/8"-24 9/16"-18	7/16" 11/16"	OA69	1540306K	\$5.93
			OA70	1540309K	4.15
1/4"	9/16"-18	11/16"	OA71	1540409K	3.61
5/16"	9/16"-18	11/16"	OA72	1540509K	4.60
3/8"	9/16"-18	11/16"	OA73	1540609K	4.32

oxygen couplings

right-hand thread for oxygen line x hose shank



Hose Size	Right UNF Thread	Hex	Previous Part #	Brass	
				Part #	Price/E
3/16"	3/8"-24 9/16"-18	7/16" 11/16"	OA59	1520306K	\$5.93
			OA60	1520309K	4.24
1/4"	9/16"-18	11/16"	OA61	1520409K	3.63
5/16"	9/16"-18	11/16"	OA62	1520509K	4.78
3/8"	9/16"-18	11/16"	OA63	1520609K	4.20

Oxy-Acetylene Connecting Spuds

left-hand thread x left-hand thread



Left UNF Thread	Hex	Previous Part #	Brass	
			Part #	Price/E
9/16"-18	11/16"	OA52	1580909C	\$4.53

right-hand thread x right-hand thread



Right UNF Thread	Hex	Previous Part #	Brass	
			Part #	Price/E
9/16"-18	11/16"	OA50	1560909C	\$4.28

Oxy-Acetylene Adapters

left-hand thread x NPTF



Left UNF Thread	NPTF Thread	Hex	Previous Part #	Brass	
				Part #	Price/E
9/16"-18	1/4"	5/8"	158-0904	1580904C	\$3.45
	3/8"	11/16"	158-0906	1580906C	4.67

right-hand thread x NPTF



Right UNF Thread	NPTF Thread	Hex	Previous Part #	Brass	
				Part #	Price/E
9/16"-18	1/4"	5/8"	156-0904	1560904C	\$3.42
	3/8"	11/16"	156-0906	1560906C	4.28

Oxy-Acetylene Ferrules

• sold in package quantities only



Inside Dimensions	Overall Length	Metal Gauge	Standard Ind. Part #	Brass		Qty
				Part #	Price/E	
.458" x 0.890"	15/32"	.019"	9116	BFO448	\$0.71	25
.474" x 0.943"	15/32"	.019"	9979	BFO474	0.52	25
.535" x 1.071"	3/4"	.024"	9940P	BFO535	0.85	25
.593" x 1.109"	3/4"	.024"	9593	BFO593	0.78	25
.700" x 1.325"	.719"	.025"	8337	BFO700	3.65	25

Micrometer Adjustable C Series Torque Wrenches

Features:

- 36 tooth quick release ratchet head
- certification readings and individual instrument serial number are included
- certified to meet the accuracy specified in ANSI B107.14M-1994, calibrated on a torque standard that is traceable to the National Institute of Standards Technology (NIST)
- accurate to $\pm 3\%$ and $\pm 5\%$ CCW of full scale

Drive	Range		Length	<i>Plated Steel</i>	
	In-Lb	Ft-Lb		Part #	Price/E
1/4"	20 - 100	---	11"	C1001	\$360.00
	40 - 200	---	16"	C2001	360.00
3/8"	---	15 - 100	17"	C1002	390.00
1/2"	---	20 - 150	24"	C1503	400.00
	---	30 - 250	24"	C2503	420.00



Maintenance
& Repair

Micrometer Adjustable Heavy Duty Industrial Torque Wrenches

Features:

- 24 tooth quick release ratchet head
- click type wrench
- equipped with 3/4" or 1" dual direction quick release, 24 tooth ratchet
- precision roll marked scale
- polished durable bright chrome finish
- fully repairable and easily calibrated
- calibrated to $\pm 3\%$ at any setting
- meets ASME B107.14B

Drive	Range Ft-Lb	Length	<i>Plated Steel</i>	
			Part #	Price/E
3/4"	50 - 450	41.9"	C4504	\$1100.00
	100 - 600	49.8"	C6004	1250.00
	150 - 750	49.8"	C7504	1400.00
1"	100 - 600	49.8"	C6005	1320.00
	150 - 750	49.8"	C7505	1600.00



Electronic Torque Wrenches

Features:

- 24 tooth quick release ratchet head
- 5 alphanumeric digit display, 4 keys: up, down, mode, unit
- 3 colored lights, vibration and audible alarm
- unit: ft-lb, in-lb and Nm.
- mode: Peak Hold
- torque setting from 5% to 100% of full scale
- accuracy torque $\pm 1\%$ both CW and CCW from 10%-100% of Indicate value
- 2 AA batteries provide up to 500 hours of continuous use
- ISO-6789-2003 and ASME B107-2005 Standard compliant
- Certificate of N.I.S.T. traceability for 10% to 100% of full scale

Drive	Range		Length	Part #	Price/E
	In-Lb	Ft-Lb			
1/4"	12.5 - 250	1 - 20.7	13"	DW2501	\$590.00
3/8"	60 - 1200	5 - 100	18"	DW1002	590.00
1/2"	150 - 3000	12.5 - 250	26.5"	DW2503	720.00



Torque and Angle Meter Pro

Features:

- 5 alphanumeric digit display, 4 keys: up, down, mode, unit
- 3 colored lights, vibration and audible alarm
- unit: ft-lb, in-lb and nM
- mode: Track, Peak Hold and Angle
- torque setting from 5% to 100% of full scale
- accuracy torque $\pm 1\%$ both CW and CCW from 10% - 100% of Indicate value
- accuracy angle: $\pm 1^\circ$ of reading $\pm 1^\circ$ from 1° to 360°
- angle setting: 5° to 360° , angular velocity $>4^\circ/\text{sec}$ and $<200^\circ/\text{sec}$
- Li-Ion rechargeable battery provides up to 200 hours use per charge
- ISO-6789-2003 and ASME B107-28-2005 Standard compliant
- Certificate of N.I.S.T. traceability for 10% to 100% of full scale



Drive	Range		Length x Width	Part #	Price/E
	In-Lb	Ft-Lb			
3/8"	30 - 600	2.5 - 50	3.5" x 2.1"	SPA502	\$630.00
	60 - 1200	5 - 100	3.5" x 2.1"	SPA1002	640.00
1/2"	90 - 1800	7.5 - 150	3.75" x 2.1"	SPA1503	650.00
	150 - 3000	12.5 - 250	3.75" x 2.1"	SPA2503	670.00
3/4"	240 - 4800	20 - 400	4.5" x 2"	SPA4004	830.00
	360 - 7200	30 - 600	4.5" x 2"	SPA6004	1100.00

Torque and Angle Meters

Features:

- 4 alphanumeric digit display, 4 keys: up, down, mode, unit
- 3 colored lights, vibration and audible alarm
- unit: ft-lb, in-lb and nM
- mode: Peak Hold and Angle
- torque setting from 5% to 100% of full scale
- accuracy torque $\pm 2\%$ both CW and CCW from 10% - 100% of Indicate value
- accuracy angle: $\pm 1^\circ$ of reading from 1° to 180°
- angle setting: 5° to 180° , angular velocity $>10^\circ/\text{sec}$ and $<200^\circ/\text{sec}$
- 3 AAA battery provides up to 200 hours of continuous use
- ISO-6789-2003 and ASME B107-28-2005 Standard compliant
- Certificate of N.I.S.T. traceability for 10% to 100% of full scale



Drive	Range		Length x Width	Part #	Price/E
	In-Lb	Ft-Lb			
3/8"	30 - 600	2.5 - 50	3.5" x 2.1"	TA502	\$470.00
	60 - 1200	5 - 100	3.5" x 2.1"	TA1002	470.00
1/2"	90 - 1800	7.5 - 150	3.75" x 2.1"	TA1503	530.00
	150 - 3000	12.5 - 250	3.75" x 2.1"	TA2503	530.00

Torque Meters

Features:

- 4 alphanumeric digit display, 4 keys: up, down, mode, unit
- 3 colored lights, vibration and audible alarm
- unit: ft-lb, in-lb and nM
- mode: Peak Hold and Angle
- torque setting from 5% to 100% of full scale
- accuracy torque $\pm 2\%$ both CW and CCW from 10% - 100% of Indicate value
- 3 AAA battery provides up to 400 hours of use per charge
- ISO-6789-2003 and ASME B107-28-2005 Standard compliant
- Certificate of N.I.S.T. traceability for 10% to 100% of full scale



Drive	Range		Length x Width	Part #	Price/E
	In-Lb	Ft-Lb			
3/8"	30 - 600	2.5 - 50	3.5" x 2.1"	TM502	\$375.00
	60 - 1200	5 - 100	3.5" x 2.1"	TM1002	375.00
1/2"	90 - 1800	7.5 - 150	3.75" x 2.1"	TM1503	430.00
	150 - 3000	12.5 - 250	3.75" x 2.1"	TM2503	430.00

Value Add Programs N-2
Hose Coupling Workshops N-2
Solutions on Site Vans..... N-2
Best Practices Safety Assessment..... N-2

Safety N-3
Be Safe..... N-3
S.T.A.M.P.E.D..... N-3

Pressure Recommendations .. N-4 to N-9

Corrosion Resistance N-10 to N-15

Dixon® Hose Coupling Workshops

In an effort to provide our customers with information regarding the proper and safe methods of assembling hose and couplings, Dixon® offers Hose Coupling Workshops suitable for a company's sales force and shop personnel.

Classes consist of lectures and/or hands-on demonstrations of coupling selection, hose preparation, coupling installation, assembly testing and maintenance procedures. Morning, afternoon and all day classes are available. For more information, please contact Dixon® at 800.355.1991.

We encourage you to share this information with anyone who may be affected by the selection, installation, maintenance or use of any hose assembly. Always use quality products to **Be Safe**.

Technical

Solutions on Site Vans by Dixon®



Our Solutions on Site (SOS) vans are outfitted with product samples, videos, literature and products representative of what Dixon® provides to specific markets. Call 800.355.1991 for additional information.

Best Practices Safety Assessment

Dixon®, in partnership with your industrial hose supplier, is pleased to offer a hose and coupling safety survey of your plant, at no cost to you, to assist in your efforts to make your facility as safe, efficient and productive as possible.

Today, plant safety is an enormous, ongoing endeavor in which it is impossible to be an expert in every field.

The use of damaged or misapplied hose couplings and related items occurs. To the untrained eye, these hazards may continue to exist until an accident happens, threatening not only plant machinery, but also the well-being of plant personnel.

Our program includes a visual inspection of hose assemblies and related accessories in your plant by trained technicians. A professionally written report containing our observations and recommendations for corrective action is subsequently provided to augment your own ongoing safety program. If desired, photographs of the areas of concern can be supplied with the report. As a follow-up, the program offers an educational hands-on seminar directly relating to the safety concerns in your facility.

Plant safety is coming under increasing scrutiny by various regulatory agencies. Let trained Dixon® personnel assist you in establishing and maintaining safety compliance in your plant.

The safety report is completely confidential and will only be shown to authorized plant personnel. For more information, please contact Dixon® at 800.355.1991.

Be Safe

Hose assemblies must be inspected prior to each use. Worn out fittings, attachment devices, hose and accessory items must be replaced. Retaining devices (safety devices) such as clips, cables or chains must be used. Clamps must be checked regularly to the specified torque found in Dixon® literature. Under no circumstance should any coupling be disconnected while under pressure unless the coupling is specifically designed to do so. Disconnecting couplings under pressure could result in serious injury or death, and destruction to property and equipment.

For all hose assemblies in use:

- Beware** - Hose assemblies when used improperly or in the wrong application can be dangerous. The maximum working pressure shown on the hose is not an indication of the working pressure of the assembly. Based on the hose, fittings and attachment method used, all assemblies should be permanently marked with the designed working pressure and the intended media. The assembly working pressure should be permanently displayed. Hose assemblies must be used for the intended service only. Never alter manufactured product or substitute component parts.
- Eliminate** - hazardous conditions by inspecting, maintaining and testing hose assemblies. Dixon® recommends that all hose assemblies be tested in accordance with the hose manufacturer's specifications. The application determines the regularity of the re-testing schedule.
- Secure** - and inspect hose, fittings, clamping devices and safety accessories before each use. Never take for granted that the coupling or attachment devices are properly installed.
- Always** - inspect and re-tighten the bolts of any bolt style clamping device to the manufacturer's torque specifications.
- Fittings** - hose and clamping devices that are worn out or damaged must be removed from service.
- Educate** - your employees about the proper use, care and potential hazards of hose assemblies. Take advantage of Dixon®'s free Best Practices Safety Assessment and the follow up Training Seminar to aid you in setting up your own inspection program. Any questions on applications, use or assembly call 800.355.1991 or email engineering@dixonvalve.com.

S.T.A.M.P.E.D.

When fabricating and specifying hose assemblies ask the following questions:

- Size:** What is the ID (Inside Diameter) of the hose? What is the OD (Outside Diameter) of both ends of the hose? What is the overall length of the assembly required?
- Temperature:** What is the temperature range of the media (product) that is flowing through the hose assembly? What is the temperature range of the environment that surrounds the outside of the hose assembly?
- Application:** How is the hose assembly actually being used? Is it a pressure application? Is it a vacuum (suction) application? Is it a gravity flow application? Are there any special requirements that the hose assembly is expected to perform? Is the hose being used in a horizontal or vertical position? Are there any pulsations or vibrations acting on the hose assembly?
- Media:** What is the media/material that is flowing through the hose assembly? Being specific is critical. Check for: abrasive materials, chemical compatibility, etc.
- Pressure:** What is the maximum pressure including surges (or, maximum vacuum) that this hose assembly will be subjected to? Always rate the maximum working pressure of your hose assembly by the lowest rated component in the system.
- Ends:** What couplings have been requested by the user? Are they the proper fittings for the application and hose selected?
- Dixon®:** Dixon® recommends that, based on the hose, fittings and attachment method used, all assemblies be permanently marked with the designed working pressure and intended media. Do not use other manufacturer's fittings or ferrules with Dixon® products due to the differences in dimensions and tolerances. We also recommend that all hose assemblies be tested frequently. *Be Safe:* Any questions on application, use or assembly call 800.355.1991 or email engineering@dixonvalve.com.

The images shown on these two pages are provided to assist in coupling and clamp or ferrule identification for the pressure recommendation chart.

Couplings

Technical



Dixon® Cam & Groove



Boss™ Couplings



Air King™ Universal



King™ Machined Medium Shank



King™ Machined Long Shank



Machined Short Shank

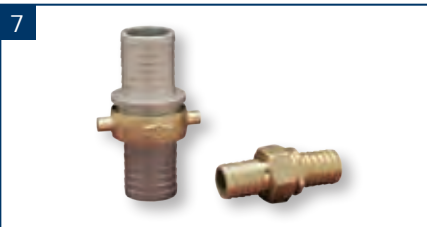

Cast Short Shank



Push-On



Reusable Brass



Holedall™ Swage / Crimp



Holedall™ Internal Expansion



Flow Chief / Sanitary



Holedall™ Internal Expansion Petroleum



King Crimp™ Couplings

⚠ WARNING

1. The chart is intended as a guide only. It only applies to metal couplings as shown for ambient temperature **70°F (21°C)** applications with true ID hose. It assumes new Dixon® supplied couplings, new Dixon® supplied clamps, new quality hose and proper installation by a qualified assembler using Dixon® procedures and equipment. Temperature can affect the coupling retention. For questions relating to temperatures other than ambient **70°F (21°C)** contact the hose manufacturer or Dixon® at 800.355.1991.
2. This chart does not apply to non-Dixon® products, with used hose, in non-approved or unsupported applications or in non-standard assemblies.
3. Do not use this chart if it conflicts with the hose manufacturer's recommendations.
4. All hose assemblies should be pressure tested to hose manufacturers or Rubber Manufacturers Association (RMA) specifications prior to being put into service.
5. Our test experience indicates that coupling retention can vary with changes in hose design. For pressure ratings other than those listed and shown, or if questions arise, please call Dixon® at 800.355.1991 for assistance.
6. All hose assembly components must be compatible with the materials and environments with which they are to come in contact.
7. Dixon® recommends that all hose assemblies be marked with the assembly working pressure and media of the intended application. Under no circumstances should the assembly working pressure exceed the working pressure of the lowest rated component (coupling, clamp, ferrule or hose).
8. For further safety information refer to page M-3.

Clamps and Ferrules



Boss™ Interlocking Clamps



Air King™ Interlocking Clamps

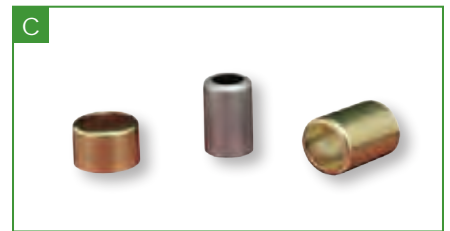

Light Duty Ferrules



Band & Buckle



Preformed Clamps



Double Bolt Clamps



Swage / Crimp



Internal Expansion



Internal Expansion Petroleum



King Crimp™ Sleeve



King Crimp™ Ferrule

Mark hose assembly with pressure from this chart or hose working pressure, whichever is lower.
 All pressure recommendations are in pounds per square inch (PSI).

Technical

- This chart is intended as a guide only. It only applies to metal couplings as shown for ambient temperature 70°F (21°C) applications with true ID hose. It assumes new Dixon® supplied couplings, new Dixon® supplied clamps, new quality hose and proper installation by a qualified assembler using Dixon® procedures and equipment.
 Temperature can affect the coupling retention. For questions relating to temperatures other than ambient 70°F (21°C) contact the hose manufacturer or Dixon® at 800.355.1991.
- This chart does not apply to non-Dixon® products, with used hose, in non-approved or unsupported applications or in non-standard assemblies.

Instructions continue at the top of the next page.

Hose (rubber covered)	DPL sect.	Group ID - Couplings	Couplings	Group ID - Clamps & Ferrules	Clamps & Ferrules	Assembly Procedure	1/4"	3/8"	1/2"	5/8"	3/4"	
Air textile reinforced rubber lined	E	3	Air King™ Universal	E	Prefomed Band Clamp	2102			150	150	150	
	E	3	Air King™ Universal	G	Swage/Crimp	2306			150		150	
	E	3	Air King™ Universal	C	Light Duty Ferrules	2307			150		150	
	F	6	Machined - Short Shank	C	Light Duty Ferrules	2304	200	150	150	100	100	
	F	6	Machined - Short Shank	E	Prefomed Band Clamp	2100-2101			150	100	100	
	G	9	Reusable - Brass	N/A	n/a	2305	250	250	250			
	F	4	King™ Machined - Medium Shank	E	Prefomed Band Clamp	2100-2101			250	200	200	
	F	5	King™ Machined - Long Shank	E	Prefomed Band Clamp	2100-2101			300	300	300	
Air textile or wire reinforced rubber lined	F	14	King™ Crimp ST - Ferrule	K	King Crimp™ Ferrule	4201						
	E	3	Air King™ Universal	B,A	Air King™ or Boss™ Interlocking Clamp	2000		150	150		150	
	E	3	Air King™ Universal	G	Swage/Crimp	2306			150		150	
	E	3	Air King™ Universal	C	Light Duty Ferrules	2307			150		150	
	D	2	Boss™ Couplings	A	Boss™ Interlocking Clamp	2000-2004	600	600	600	600	600	
	K	10	Holedall™ Swage/Crimp	G	Swage/Crimp	see Ram Manual	600	600	600	600	600	
Asphalt & Hot Tar	F	14	King Crimp™ ST - Ferrule	K	King Crimp™ Ferrule	4201						
	D	2	Boss™ Couplings	A	Boss™ Interlocking Clamp	2001-2002						
	F	4	King™ Machined - Medium Shank	E	Prefomed Band Clamp	2100-2101			125		125	
	F	4	King™ Machined - Medium Shank	D	Band & Buckle	2104						
	F	5	King™ Machined - Long Shank	E	Prefomed Band Clamp	2100-2101			150		150	
	F	5	King™ Machined - Long Shank	D	Band & Buckle	2104						
	A	1	Boss-Lock™ Cam & Groove	E	Prefomed Band Clamp	2100-2101			150		150	
	A	1	Boss-Lock™ Cam & Groove	D	Band & Buckle	2104						
	A	1	Boss-Lock™ Cam & Groove	G	Swage/Crimp	see Ram Manual					250	
	K	10	Holedall™ Swage/Crimp	G	Swage/Crimp	see Ram Manual			600		600	
	F	14	King Crimp™ ST - Ferrule	K	King Crimp™ Ferrule	4201						
	F	14	King Crimp™ ST - Sleeve	J	King Crimp™ Sleeve	4200						
	A	14	King Crimp™ Cam & Groove - Ferrule	K	King Crimp™ Ferrule	4201						
	Chemical plastic lined for liquid service	A	14	King Crimp™ Cam & Groove - Ferrule	K	King Crimp™ Ferrule	4201					
A		14	King Crimp™ Cam & Groove - Sleeve	J	King Crimp™ Sleeve	4200						
F		4	King™ Machined - Medium Shank	E	Prefomed Band Clamp	2100-2101			125		125	
F		4	King™ Machined - Medium Shank	D	Band & Buckle	2104						
F		5	King™ Machined - Long Shank	E	Prefomed Band Clamp	2100-2101			150		150	
F		5	King™ Machined - Long Shank	D	Band & Buckle	2104						
A		1	Boss-Lock™ Cam & Groove	E	Prefomed Band Clamp	2100-2101			150		150	
A		1	Boss-Lock™ Cam & Groove	D	Band & Buckle	2104						
A		1	Boss-Lock™ Cam & Groove	G	Swage/Crimp	see Ram Manual					250	
D		2	Boss™ Couplings	A	Boss™ Interlocking Clamp	2000-2004			600		600	
K		11	Holedall™ Internal Expansion	H	Internal Expansion	see Ram Manual						
F		14	King Crimp™ ST - Ferrule	K	King Crimp™ Ferrule	4201						
F		14	King Crimp™ ST - Sleeve	J	King Crimp™ Sleeve	4200						
A		14	King Crimp™ Cam & Groove - Ferrule	K	King Crimp™ Ferrule	4201						
A		14	King Crimp™ Cam & Groove - Sleeve	J	King Crimp™ Sleeve	4200						
Food Grade conforming to 3A		K	10	Holedall™ Swage/Crimp	G	Swage/Crimp	see Ram Manual			600		600
		K	12	Flow Chief Sanitary	H	Internal Expansion	see Ram Manual					
Food Grade rubber lined		F	4	King™ Machined - Medium Shank	E	Prefomed Band Clamp	2100-2101			125		125
	F	4	King™ Machined - Medium Shank	D	Band & Buckle	2104						
	A	1	Boss-Lock™ Cam & Groove	E	Prefomed Band Clamp	2100-2101			150		150	
	A	1	Boss-Lock™ Cam & Groove	D	Band & Buckle	2104						
	A	1	Boss-Lock™ Cam & Groove	G	Swage/Crimp	see Ram Manual					250	
	K	11	Holedall™ Internal Expansion	H	Internal Expansion	see Ram Manual						
	K	10	Holedall™ Swage/Crimp	G	Swage/Crimp	see Ram Manual			600		600	
	F	14	King Crimp™ ST - Ferrule	K	King Crimp™ Ferrule	4201						
	F	14	King Crimp™ ST - Sleeve	J	King Crimp™ Sleeve	4200						
	A	14	King Crimp™ Cam & Groove - Ferrule	K	King Crimp™ Ferrule	4201						
	A	14	King Crimp™ Cam & Groove - Sleeve	J	King Crimp™ Sleeve	4200						

3. Do not use this chart if it conflicts with the hose manufacturer's recommendations.
4. All hose assemblies should be pressure tested to hose manufacturers or Association for Rubber Products Manufacturer's (ARPM) specifications prior to being put into service.
5. Our test experience indicates that coupling retention can vary with changes in hose design. For pressure ratings other than those listed and shown, or if questions arise, please call Dixon® at 800.355.1991 for assistance.
6. All hose assembly components must be compatible with the materials and environments with which they are to come in contact.
7. Dixon® recommends that all hose assemblies be marked with the assembly working pressure and media of the intended application. Under no circumstances should the assembly working pressure exceed the working pressure of the lowest rated component (coupling, clamp, ferrule or hose).
8. For further safety information refer to page M-3.

Procedures can be found at dixonvalve.com or requested by calling 800.355.1991.

Hose (rubber covered)	1"	1¼"	1½"	2"	2½"	3"	4"	5"	6"	Notes	
Air textile reinforced rubber lined	150									(2) bands on ¾" or larger; Must use mating Dixon® Air King™ fittings with safety clip installed.	
	150									Coupling and ferrule are sold assembled. Must use mating Dixon® Air King™ fittings with safety clip installed.	
	150									(14) Coupling and ferrule are sold separately. Must use mating Dixon® Air King™ fittings with safety clip installed.	
	100										
	100										
											(2) bands on ½" to 1"
		150									
Air textile or wire reinforced rubber lined	300										
	400		350	300		300	300		230	(13) crimp length would be full length	
	150									Must use mating Dixon® Air King™ fittings with safety clip installed.	
	150									Coupling and ferrule are sold assembled. Must use mating Dixon® Air King™ fittings with safety clip installed.	
	150									(14) Coupling and ferrule are sold separately. Must use mating Dixon® Air King™ fittings with safety clip installed.	
	600	600	600	600	450	450	250		250		
Asphalt & Hot Tar	600	600	600	600	600	600	500	450	400		
	400		350	300		300	300		230	(13) crimp length would be full length	
	200	200	200	200	200	200	200			Consult Dixon®	
	125	125	125	75	75	50	50			(3) bands on 3" & 4"; (2) bands on 1½" to 2½"; (1) band on the rest	
		125	125	75	75	50	50			(3) bands on 3" & 4"; (2) bands on 1½" to 2½"; (1) band on the rest	
	150	150	150	125	100	75	75			(5) bands on 3" & 4"; (4) bands on 2" & 2½"; (3) bands on 1¼" & 1½"; (2) bands on the rest	
Chemical plastic lined for liquid service		150	150	125	100	75	75			(5) bands on 3" & 4"; (4) bands on 2" & 2½"; (3) bands on the rest	
	250	250	250	250	150	125	100				
		250	250	250	150	125	100				
	250		250	250	150	125	100			Requires properly matched stem and ferrule.	
	600	600	600	600	600	600	500				
	400		350	300		300	300		230	(13) crimp length would be full length	
	400		300	250		200	175		75	(13) crimp length would be full length	
	250		250	250		150	150		75	(13) crimp length would be full length	
	250		250	250		125	110		75	(13) crimp length would be full length	
	250		250	250		125	100			Requires properly matched stem and ferrule.	
Chemical rubber lined for liquid service	600	600	600	600	450	450	250				
	800	800	800	800	600	600	500			Consult factory for ratings on IXF48-3 to IXF48-5 & IXF64-2 to IXF64-5 ferrules. Internal Expansion is NOT recommended for XLPE, UHMWPE & Gum Rubber lined hoses.	
	400		350	300		300	300		230	(13) crimp length would be full length	
	400		300	250		200	175		75	(13) crimp length would be full length	
	250		250	250		150	150		75	(13) crimp length would be full length	
	250		250	250		125	110		75	(13) crimp length would be full length	
	600	600	600	600	600	600	500				
	Food Grade conforming to 3A										
	Food Grade rubber lined	125	125	125	75	75	50	50	25	25	(4) bands on 6"; (3) bands on 3" to 5"; (2) bands on 1½" to 2½"; (1) band on the rest
			125	125	75	75	50	50	25	25	(4) bands on 6"; (3) bands on 3" to 5"; (2) bands on 1½" to 2½"; (1) band on the rest
250		250	250	250	150	125	100	75	75	(3) bands on 6"; (2) bands on the rest	
		250	250	205	150	125	100	75	75	(3) bands on 6"; (2) bands on the rest	
250			250	250		125	100			Requires properly matched stem and ferrule.	
250			250	250	250	250	200				
600		600	600	600	600	600	500	450	400		
400			350	300		300	300		230	(13) crimp length would be full length	
400			300	250		200	175		75	(13) crimp length would be full length	
250			250	250		150	150		75	(13) crimp length would be full length	
250		250	250		125	110		75	(13) crimp length would be full length		

Pressure Recommendations

Technical

Hose (rubber covered)	DPL sect.	Group ID - Couplings	Couplings	Group ID - Clamps & Ferrules	Clamps & Ferrules	Assembly Procedure	1/4"	3/8"	1/2"	5/8"	3/4"
Material Handling <i>rubber lined</i>	F	7	Cast Short Shank	E	Prefomed Band Clamp	2100-2101					
	F	7	Cast Short Shank	D	Band & Buckle	2104					
	F	4	King™ Machined - Medium Shank	E	Prefomed Band Clamp	2100-2101					
	F	4	King™ Machined - Medium Shank	D	Band & Buckle	2104					
	F	5	King™ Machined - Long Shank	E	Prefomed Band Clamp	2100-2101					
	F	5	King™ Machined - Long Shank	D	Band & Buckle	2104					
	A	1	Boss-Lock™ Cam & Groove	E	Prefomed Band Clamp	2100-2101					
	A	1	Boss-Lock™ Cam & Groove	D	Band & Buckle	2104					
	A	1	Boss-Lock™ Cam & Groove	G	Swage/Crimp	see Ram Manual					
	K	10	Holedall™ Swage/Crimp	G	Swage/Crimp	see Ram Manual					
	K	11	Holedall™ Internal Expansion	H	Internal Expansion	see Ram Manual					
	F	14	King Crimp™ ST - Ferrule	K	King Crimp™ Ferrule	4201					
	F	14	King Crimp™ ST - Sleeve	J	King Crimp™ Sleeve	4200					
	A	14	King Crimp™ Cam & Groove - Ferrule	K	King Crimp™ Ferrule	4201					
A	14	King Crimp™ Cam & Groove - Sleeve	J	King Crimp™ Sleeve	4200						
Material Handling <i>no helical wire rubber lined</i>	F	7	Cast Short Shank	F	Double Bolt Clamp	2201					
	F	4	King™ Machined - Medium Shank	F	Double Bolt Clamp	2201					
	F	5	King™ Machined - Long Shank	F	Double Bolt Clamp	2201					
	F	14	King™ Crimp ST - Ferrule	K	King Crimp™ Ferrule	4201					
	F	14	King™ Crimp ST - Sleeve	J	King Crimp™ Sleeve	4200					
	A	14	King™ Crimp Cam & Groove - Ferrule	K	King Crimp™ Ferrule	4201					
	A	14	King™ Crimp Cam & Groove - Sleeve	J	King Crimp™ Sleeve	4200					
	D	2	Boss™ Couplings	A	Boss™ Interlocking Clamp	2000-2004					
	K	10	Holedall™ Swage/Crimp	G	Swage/Crimp	see Ram Manual					
	K	11	Holedall™ Internal Expansion	H	Internal Expansion	see Ram Manual					
Material Handling <i>cement rubber lined</i>	F	4	King™ Machined - Medium Shank	E	Prefomed Band Clamp	2100-2101			125		125
	F	4	King Machined - Medium Shank	D	Band & Buckle	2104					
	F	5	King Machined - Long Shank	E	Prefomed Band Clamp	2100-2101			150		150
	F	5	King™ Machined - Long Shank	D	Band & Buckle	2104					
	A	1	Boss-Lock™ Cam & Groove	E	Prefomed Band Clamp	2100-2101			150		250
	A	1	Boss-Lock™ Cam & Groove	D	Band & Buckle	2104					
	A	1	Boss-Lock™ Cam & Groove	G	Swage/Crimp	see Ram Manual					250
	K	11	Holedall™ Internal Expansion	H	Internal Expansion	see Ram Manual					
	K	10	Holedall™ Swage/Crimp	G	Swage/Crimp	see Ram Manual			600		600
	F	14	King Crimp™ ST - Ferrule	K	King Crimp™ Ferrule	4201					
	F	14	King Crimp™ ST - Sleeve	J	King Crimp™ Sleeve	4200					
	A	14	King Crimp™ Cam & Groove - Ferrule	K	King Crimp™ Ferrule	4201					
	A	14	King Crimp™ Cam & Groove - Sleeve	J	King Crimp™ Sleeve	4200					
	Air Craft Refueling <i>conforming to API 1529</i>	K	13	Holedall™ Petroleum Internal Expansion	I	Internal Expansion (Petroleum)	see Ram Manual				
Push-On	G	8	Push-On	N/A	n/a	2001-2002	350	350	350	350	350
Steam	D	2	Boss™ Couplings	A	Boss™ Interlocking Clamp	2000-2004			250		250
Water	E	3	Air King™ Universal	E	Prefomed Band Clamp	2100-2101			150	150	150
	E	3	Air King™ Universal	B,A	Air King™ or Boss™ Interlocking Clamp	2000-2001		150	150		150
	E	3	Air King™ Universal	C	Light Duty Ferrules	2307			150		150
	F	6	Machined - Short Shank	E	Prefomed Band Clamp	2100-2101			150	100	100
	F	6	Machined - Short Shank	C	Light Duty Ferrules	2304	200	150	150	100	100
	F	7	Cast Short Shank	E	Prefomed Band Clamp	2100-2101			150	100	100
	F	7	Cast Short Shank	D	Band & Buckle	2104					
	F	4	King™ Machined - Medium Shank	E	Prefomed Band Clamp	2100-2101			250	200	200
	F	5	King™ Machined - Long Shank	E	Prefomed Band Clamp	2100-2101			300	300	300
	A	1	Boss-Lock™ Cam & Groove	E	Prefomed Band Clamp	2100-2101			150		250
	A	1	Boss-Lock™ Cam & Groove	D	Band & Buckle	2104					
	A	1	Boss-Lock™ Cam & Groove	G	Swage/Crimp	see Ram Manual					250
	D	2	Boss™ Couplings	A	Boss™ Interlocking Clamp	2000-2002	600	600	600	600	600
	K	10	Holedall™ Swage/Crimp	G	Swage/Crimp	see Ram Manual	600	600	600	600	600
	F	14	King Crimp™ ST - Ferrule	K	King Crimp™ Ferrule	4201					
	F	14	King Crimp™ ST - Sleeve	J	King Crimp™ Sleeve	4200					
	A	14	King Crimp™ Cam & Groove - Ferrule	K	King Crimp™ Ferrule	4201					
	A	14	King Crimp™ Cam & Groove - Sleeve	J	King Crimp™ Sleeve	4200					
Water <i>no helical wire</i>	F	7	Cast Short Shank	F	Double Bolt Clamp	2201					
	F	4	King™ Machined - Medium Shank	F	Double Bolt Clamp	2201					
	F	5	King™ Machined - Long Shank	F	Double Bolt Clamp	2201					
	F	14	King™ Crimp ST - Ferrule	K	King Crimp™ Ferrule	4201					
	F	14	King™ Crimp ST - Sleeve	J	King Crimp™ Sleeve	4200					
	A	14	King™ Crimp Cam & Groove - Ferrule	K	King Crimp™ Ferrule	4201					
	A	14	King™ Crimp Cam & Groove - Sleeve	J	King Crimp™ Sleeve	4200					

Pressure Recommendations

Hose (rubber covered)	1"	1¼"	1½"	2"	2½"	3"	4"	5"	6"	Notes	
Material Handling <i>rubber lined</i>			75	75	50	50	50	25	25	(4) bands on 6"; (3) bands on 3" to 5"; (2) bands on 1½" to 2½"	
			75	75	50	50	50	25	25	(4) bands on 6"; (3) bands on 3" to 5"; (2) bands on 1½" to 2½"	
			125	75	75	50	50	25	25	(4) bands on 6"; (3) bands on 3" to 5"; (2) bands on 1½" to 2½"	
			125	75	75	50	50	25	25	(4) bands on 6"; (3) bands on 3" to 5"; (2) bands on 1½" to 2½"	
			150	125	100	75	75			(5) bands on 3" & 4"; (4) bands on 2" & 2½"; (3) bands on the rest	
			150	125	100	75	75			(5) bands on 3" & 4"; (4) bands on 2" & 2½"; (3) bands on the rest	
			250	250	150	125	100	75	75	(3) bands on 6"; (2) bands on the rest	
			250	250	150	125	100	75	75	(3) bands on 6"; (2) bands on the rest	
			250	250		125	100			Requires properly matched stem and ferrule.	
			600	600	600	600	500	450	400		
			800	800	600	600	500		400	Consult factory for ratings on IXF48-3 to IXF48-5 & IXF64-2 to IXF64-5 ferrules. Internal Expansion is NOT recommended for XLPE, UHMWPE & Gum Rubber lined hoses.	
		400		350	300		300	300		230	(13) crimp length would be full length
		400		300	250		200	175		75	(13) crimp length would be full length
	250		250	250		150	150		75	(13) crimp length would be full length	
	250		250	250		125	110		75	(13) crimp length would be full length	
Material Handling <i>no helical wire rubber lined</i>			75	75	50	50	50	25	25	(3) double bolt clamps on 5" & 6"; (2) double bolt clamps on 3" to 4"; (1) double bolt clamp on the rest	
			125	75	75	50	50	25	25	(3) double bolt clamps on 5" & 6"; (2) double bolt clamps on 3" to 4"; (1) double bolt clamp on the rest	
			150	125	100	75	75			(3) double bolt clamps on all sizes	
		400		350	300		300	300		230	(13) crimp length would be full length
		400		300	250		200	175		75	(13) crimp length would be full length
		250		250	250		150	150		75	(13) crimp length would be full length
		250		250	250		125	110		75	(13) crimp length would be full length
Material Handling <i>cement rubber lined</i>	600	600	600	600	450	450	250		250	Cement will erode ID	
	600	600	600	600	600	600	500	450	400	Cement will erode ID	
	800	800	800	800	600	600	500		400	Cement will erode ID Consult Dixon® for ratings on IXF48-3 to IXF48-5 & IXF64-2 to IXF64-5 ferrules.	
Petroleum Transfer	125	125	125	75	75	50	50	25	25	(4) bands on 6"; (3) bands on 3" to 5"; (2) bands on 1½" to 2½"; (1) band on the rest	
		125	125	75	75	50	50	25	25	(4) bands on 6"; (3) bands on 3" to 5"; (2) bands on 1½" to 2½"; (1) band on the rest	
	150	150	150	125	100	75	75			(5) bands on 3" & 4"; (4) bands on 2" & 2½"; (3) bands on 1¼" & 1½"; (2) bands on the rest	
		150	150	125	100	75	75			(5) bands on 3" & 4"; (4) bands on 2" & 2½"; (3) bands on the rest	
	250	250	250	250	150	125	100	75	75	(3) bands on 6"; (2) bands on the rest	
		250	250	250	150	125	100	75	75	(3) bands on 6"; (2) bands on the rest	
	250		250	250		125	100			Requires properly matched stem and ferrule.	
	800	800	800	800	600	600	500		400	Consult factory for ratings on IXF48-3 to IXF48-5 & IXF64-2 to IXF64-5 ferrules.	
	600	600	600	600	600	600	500	450	400		
	400		350	300		300	300		230	(13) crimp length would be full length	
	400		300	250		200	175		75	(13) crimp length would be full length	
	250		250	250		150	150		75	(13) crimp length would be full length	
	250		250	250		125	110		75	(13) crimp length would be full length	
Air Craft Refueling conforming to API 1529	300	300	300	300	300	300					
Push-On										Push-On fittings should ONLY be used on Push-On hose.	
Steam	250	250	250	250	250	250			250		
Water	150									(2) bands on ¾" or larger; Must use mating Dixon® Air King™ fittings with safety clip installed. Band & Buckle is NOT recommended for 1½" and smaller.	
	150									Must use mating Dixon® Air King™ fittings with safety clip installed. Band & Buckle is NOT recommended for 1½" and smaller.	
	150									(14) Coupling and ferrule are sold separately. Must use mating Dixon® Air King™ fittings with safety clip installed.	
	100									(1) band; Band & Buckle is NOT recommended for 1½" and smaller.	
	100										
	100	75	75	75	50	50	50	25	25	(4) bands on 6"; (3) bands on 3" to 5"; (2) bands on 1½" to 2½"; (1) band on the rest	
		75	75	75	50	50	50	25	25	(4) bands on 6"; (3) bands on 3" to 5"; (2) bands on 1½" to 2½"; (1) band on the rest	
	150	150	125	75	75	50	50	25	25	(4) bands on 6"; (3) bands on 3" to 5"; (2) bands on 1½" to 2½"; (1) band on the rest	
	300	300	150	125	100	75	75			(5) bands on 3" & 4"; (4) bands on 2" & 2½"; (3) bands on 1¼" & 1½"; (2) bands on the rest	
	250	250	250	250	150	125	100	75	75	(3) bands on 6"; (2) bands on the rest	
		250	250	250	150	125	100	75	75	(3) bands on 6"; (2) bands on the rest	
	250		250	250		125	100			Requires properly matched stem and ferrule.	
	600	600	600	600	450	450	250		250		
600	600	600	600	600	600	500	450	400			
400		350	300		300	300		230	(13) crimp length would be full length		
400		300	250		200	175		75	(13) crimp length would be full length		
250		250	250		150	150		75	(13) crimp length would be full length		
250		250	250		125	110		75	(13) crimp length would be full length		
Water <i>no helical wire</i>			75	75	50	50	50	25	25	(3) double bolt clamps on 5" & 6"; (2) double bolt clamps on 3" to 4"; (1) double bolt clamp on the rest	
			125	75	75	50	50	25	25	(3) double bolt clamps on 5" & 6"; (2) double bolt clamps on 3" to 4"; (1) double bolt clamp on the rest	
			150	125	100	75	75			(3) double bolt clamps on all sizes	
	400		350	300		300	300		230	(13) crimp length would be full length	
	400		300	250		200	175		75	(13) crimp length would be full length	
	250		250	250		150	150		75	(13) crimp length would be full length	
	250		250	250		125	110		75	(13) crimp length would be full length	

⚠ WARNING

The data on the following pages has been compiled from generally available sources and should not be relied upon without consulting and following the specific recommendations of the manufacturer regarding particular coupling materials.

Technical

Ratings

Metal
1 = Excellent 2 = Good 3 = Fair X = Not Recommended - = Contact Dixon®

Non-Metal
A = Acceptable X = Not Recommended - = Contact Dixon®

Gasket/Seal Material
T = PTFE V = FKM E = EPDM, EPR N = Neoprene B = Buna N

1. Ratings given are based at **70°F (21°C)**. Chemical compatibility varies greatly with temperature. For applications at temperatures other than **70°F (21°C)**, contact Dixon® for recommendations at 800.355.1991 or email engineering@dixonvalve.com.
2. Gasket / seal materials are not necessarily listed in order of preference.
3. Chemical resistance of a material does not necessarily indicate the suitability of a fitting in a given application due to variables such as improper clamp and coupling application, special hose construction, gasket material, etc.



Special caution should be taken when handling hazardous materials.

AGENT	Aluminum	Brass	Bronze	Hastelloy, C-276	Malleable Iron Carbon Steel	Monel	Stainless Steel, 304	Stainless Steel, 316	Nylon	Polypropylene	Seal Material
Acetate Solvents (Crude)	1	X	X	1	2	2	1	1	A	X	T
Acetate Solvents (Pure)	1	1	1	1	X	1	1	1	A	X	T
Acetic Acid (80%)	3	X	X	1	X	1	1	1	X	X	TEVNB
Acetic Acid (50%)	2	X	X	1	X	2	2	1	X	X	TEVNB
Acetic Acid (20%)	2	X	X	1	X	2	2	1	X	X	TEVNB
Acetic Acid (10%)	2	X	2	1	X	2	1	1	X	X	TEVNB
Acetic Anhydride	2	X	2	1	2	2	2	2	X	X	TNB
Acetone	1	2	2	1	2	1	1	1	A	X	TE
Acetylene	1	X	X	2	2	2	1	1	X	X	TEVNB
Alcohols											
Amyl Alcohol	2	2	2	2	2	1	2	2	A	A	TEVNB
Benzyl Alcohol	2	2	2	2	2	1	1	1	X	A	TVB
Butyl Alcohol	1	2	1	2	2	1	1	1	A	A	TEVN
Diacetone Alcohol	1	1	2	1	2	1	2	2	X	A	TE
Ethyl Alcohol	1	2	2	1	2	2	2	2	X	A	TEVNB
Hexyl Alcohol	-	-	-	1	-	-	-	-	A	-	-
Isobutyl Alcohol	-	-	-	-	-	-	-	-	A	-	-
Isopropyl Alcohol	2	2	2	2	2	2	2	2	A	A	TEVNB
Methyl Alcohol (Methanol)	2	2	2	1	2	2	2	2	A	A	TENB
Octyl Alcohol	-	-	-	-	-	-	-	-	A	-	-
Propyl Alcohol	2	2	2	1	2	2	1	1	X	A	TEVNB
Aluminum											
Aluminum Chloride (Aqu.)	X	X	X	1	X	X	X	X	A	A	TEVNB
Aluminum Fluoride (Sat.)	2	-	-	-	X	2	X	2	X	A	TEVNB
Aluminum Nitrate (Sat.)	3	X	-	-	X	-	2	2	A	A	TEVNB
Aluminum Potassium Sulfate (Alum)	2	2	2	2	X	2	X	2	X	A	TEVNB
Aluminum Sulfate (Sat.)	X	X	2	2	X	2	-	2	A	A	TEVNB
Ammonia											
Ammonia Anhydrous	1	X	X	2	1	1	2	1	A	X	TENB
Ammonia Gas	X	X	X	1	1	X	1	1	A	X	TENB
Ammonia Nitrate	-	-	-	-	-	-	-	-	X	-	-
Ammonium											
Ammonium Bifluoride	-	X	-	2	X	2	-	-	X	A	TEVB
Ammonium Carbonate (Sat.)	2	X	X	2	2	2	2	2	A	A	TEVNB
Ammonium Casenate	-	-	-	-	-	-	-	-	A	-	-
Ammonium Chloride (Sat.)	X	X	2	2	X	2	X	X	A	A	TEVNB
Ammonium Hydroxide (Sat.)	2	X	X	2	1	X	2	2	A	A	TEVNB
Ammonium Nitrate	2	X	X	-	X	X	-	-	A	A	TENB
Ammonium Phosphate (10-40%)	X	X	X	-	X	2	1	2	A	A	TEVNB
Ammonium Sulfate (10-40%)	X	X	3	2	X	2	X	2	A	A	TEVNB
Aniline	-	X	2	2	X	2	1	1	X	X	TV
Arsenic Acid	X	X	2	2	X	X	2	2	X	A	TEVNB
Asphalt	-	-	-	-	2	-	-	2	X	X	TV
Barium											
Barium Carbonate (Sat.)	X	2	2	2	2	2	2	2	A	A	TEVNB
Barium Chloride (Sat.)	-	2	2	1	-	2	X	-	A	A	TEVNB
Barium Hydroxide (Sat.)	X	2	X	2	2	1	2	2	A	A	TEVNB
Barium Sulfate	2	2	2	-	X	2	2	2	A	A	TEVNB
Barium Sulfide	X	X	X	-	2	X	2	2	A	A	TEVNB
Beer	1	2	2	1	2	1	1	1	A	A	TEVNB
Benzaldehyde	2	2	2	2	X	2	2	2	X	X	TE
Benzene, Benzol	1	2	2	2	2	2	2	2	A	X	TV
Benzine	-	-	-	-	-	-	-	-	A	X	-
Benzoic Acid	2	2	2	-	X	2	2	2	X	X	TVN
Black Liquor	X	X	X	X	-	2	2	2	X	A	TEVNB
Bleach (12.5% Active Chlorine)	X	-	-	1	X	-	-	X	X	A	TEVN
Borax	X	2	2	1	2	1	1	1	X	A	TEVNB
Boric Acid	1	X	2	1	X	2	-	-	X	A	TEVNB
Brine Acid	-	2	2	1	-	-	-	-	X	A	TEVNB
Bromic acid	X	X	X	-	-	X	-	-	X	A	TEVN
Bromine Liquid	2	-	-	-	-	-	X	X	X	X	TV
Butadiene, Butylene	2	2	2	2	2	1	2	2	X	X	TVNB
Butane	2	2	2	2	1	1	2	2	X	X	TV
Butyl Acetate	1	2	2	2	2	2	2	2	A	X	T
Butyric Acid	2	2	X	1	X	2	2	2	A	A	TV

Technical

Ratings given are based at 70°F (21°C).



Technical

AGENT	Aluminum	Brass	Bronze	Hastelloy, C-276	Malleable Iron Carbon Steel	Monel	Stainless Steel,304	Stainless Steel,316	Nylon	Polypropylene	Seal Material
Calcium											
Calcium Bisulfate	X	-	X	-	X	X	X	2	X	A	T
Calcium Bisulfide	-	-	-	-	-	2	-	2	A	A	TVB
Calcium Bisulfite	X	X	2	2	X	X	-	2	X	A	TVNB
Calcium Bromide	X	2	2	-	X	2	1	X	X	X	T
Calcium Carbonate	X	2	2	2	2	2	1	2	A	A	TEVB
Calcium Chloride (Sat.)	-	2	-	1	2	2	-	-	A	A	TEVNB
Calcium Hydroxide (Sat.)	X	2	X	-	2	2	2	2	A	A	TEVNB
Calcium Hypochlorite (Sat.)	X	X	X	-	X	X	X	2	X	A	TEV
Carbon											
Carbon Bisulfide	1	X	2	2	2	X	2	2	A	X	TV
Carbon Dioxide (Dry)	1	1	2	1	2	1	2	2	A	A	TENB
Carbon Dioxide (Wet)	1	X	-	2	3	-	2	2	X	A	TENB
Carbon Disulfide	1	X	2	2	2	X	2	2	A	X	TV
Carbon Monoxide	1	1	1	1	2	1	1	1	A	A	TEVNB
Carbon Tetrachloride	X	-	1	1	2	1	1	-	A	X	TV
Carbonic Acid	1	2	2	1	2	3	2	2	X	A	TEVNB
Castor Oil	2	2	2	1	2	1	2	2	X	A	TEVNB
Caustic Potash	X	-	-	1	X	-	-	2	A	A	TEVNB
Caustic Soda (see Sodium Hydroxide)											
Cellosolves	2	2	2	2	2	2	2	2	X	A	TE
Chlorine (Liquid)	-	-	-	1	2	2	-	3	X	X	TV
Chloroform	-	-	-	2	X	1	-	-	X	X	TV
Chlorosulfonic Acid	-	X	X	1	2	2	X	X	X	X	T
Clorox (Bleach, 5.5% CL)	X	-	-	-	X	-	-	2	X	-	TEVB
Chromic Acid (50%)	2	X	X	2	X	X	3	-	X	X	TVNB
Citric Acid	3	X	X	1	X	2	-	-	X	A	TEVNB
Coke Oven Gas	2	3	3	-	2	2	2	2	X	X	TEVN
Copper											
Copper Chloride	X	X	X	2	X	X	X	X	A	A	TEVNB
Copper Cyanide	X	X	X	1	-	X	2	2	X	-	TEVNB
Copper Sulfate	X	X	X	1	X	X	-	2	A	A	TEVNB
Cryslc Acid (Conc.)	2	2	X	-	2	3	2	2	X	X	TEV
Cyclohexane	2	2	2	2	2	1	2	2	A	X	TVB
Detergents	2	2	2	1	2	-	1	2	A	A	TEVNB
Dextrose	2	-	-	2	-	2	-	-	A	A	TEVNB
Diesel Fuels	1	1	1	2	2	-	1	1	A	X	TVB
Diethylamine	2	-	X	-	X	1	2	2	X	A	TN
Disodium Phosphate	-	-	-	-	1	-	-	1	A	A	TEV
Ethers	2	2	2	2	2	2	1	1	A	X	TB
Ethyl											
Ethyl Acetate	-	-	2	2	2	2	2	2	A	X	T
Ethyl Chloride	-	-	2	2	2	2	-	1	A	X	TEVB
Ethylene											
Ethylene Chloride	-	-	-	-	2	2	-	-	A	X	TV
Ethylene Dichloride	-	2	X	2	2	1	2	2	A	X	TV
Ethylene Glycol	1	2	2	1	2	2	2	2	A	X	TEVNB
Ethylene Oxide	X	X	X	1	3	2	2	2	X	X	T
Fatty Acids	1	3	3	1	X	2	-	1	A	A	TVNB
Ferric											
Ferric Chloride	X	X	2	2	X	X	X	X	X	A	TEVNB
Ferric Hydroxide	-	-	-	1	-	2	1	1	A	-	TEVNB
Ferric Nitrate (10-50%)	X	X	X	-	X	X	2	2	X	A	TEVNB
Ferric Sulfate	X	X	X	-	X	2	-	-	X	A	TEVNB
Ferrous											
Ferrous Chloride (Sat.)	X	X	2	2	-	X	X	X	X	A	TEVNB
Ferrous Sulfate	2	2	2	2	X	2	2	-	X	A	TEVNB
Fluboric Acid	X	-	-	1	1	2	-	-	X	A	TEVNB
Formaldehyde (50%)	-	2	2	2	X	2	1	1	X	A	TEN
Formic Acid (Anhyd.)	1	X	2	1	X	2	-	-	X	A	TEVN
Freon											
Freon 11	2	2	2	-	X	1	2	2	X	X	TVNB
Freon 12	2	2	2	1	X	2	2	2	X	X	TVNB
Freon 22	2	2	2	2	X	2	2	2	X	X	TN
Fruit Juices	2	2	3	1	X	1	2	2	A	A	TVNB
Fuel Oil	2	2	2	2	2	2	2	2	A	X	TVNB
Furfural	2	2	2	2	2	2	2	2	A	X	TEN

Corrosion Resistance of Coupling Material

N

AGENT	Aluminum	Brass	Bronze	Hastelloy, C-276	Malleable Iron Carbon Steel	Monel	Stainless Steel, 304	Stainless Steel, 316	Nylon	Polypropylene	Seal Material
Gasoline											
Refined Gasoline	2	2	2	2	2	2	2	2	A	X	TVNB
Sour Gasoline	X	2	2	2	2	X	2	2	A	X	TVNB
Gelatin	2	2	2	-	X	2	2	2	A	A	TEVNB
Glucose	2	2	2	-	2	2	2	2	A	A	TEVNB
Glue	2	2	2	1	2	2	-	2	-	A	TEVNB
Glycerine	1	1	2	1	2	1	1	1	A	A	TEVNB
Glycols	2	2	2	-	2	2	2	2	A	A	TEVNB
Green Liquor	-	-	-	-	2	-	-	-	-	A	TEVNB
Heptane	2	2	2	1	2	2	2	2	A	X	TVNB
Hexane	2	2	2	1	2	2	1	1	A	X	TVNB
Hydrobromic Acid (50%)	X	X	X	2	X	X	X	X	X	A	TEV
Hydrobromic Acid (20%)	X	X	X	1	X	X	X	X	X	A	TEV
Hydrochloric Acid (20%)	X	X	X	1	X	3	X	X	X	A	TEVNB
Hydrochloric Acid (38%)	X	X	X	1	X	X	X	X	X	A	TEVN
Hydrocyanic Acid	2	X	X	2	2	2	2	2	X	A	TEVN
Hydrofluosilicic Acid (10-50%)	X	2	X	2	X	2	X	2	X	-	TEVNB
Hydrogen											
Hydrogen Peroxide (50%)	-	X	X	2	X	2	-	-	X	A	TEV
Hydrogen Sulfide (Aqu.)	-	-	-	2	-	2	X	2	X	A	TE
Hydrogen Chloride (Dry Gas)	X	2	-	1	2	1	-	-	X	A	TEVN
Hydrogen Gas	1	1	1	1	-	1	1	1	X	A	TEVNB
Hypochlorous Acid	X	X	X	2	X	X	X	X	X	X	TEV
Iodine	1	X	X	-	X	1	X	X	X	A	TEV
Isopropyl Ether	-	2	2	-	-	2	1	2	A	X	T
Jet Fuel (JP4, JP5)	2	1	2	1	2	2	2	2	X	X	TV
Kerosene	2	2	2	2	2	2	2	2	X	X	TVNB
Ketones	2	2	2	1	2	2	2	2	A	X	T
Lactic Acid (25%)	3	2	2	1	X	X	-	-	A	A	TEVN
Lactic Acid (80%)	2	2	X	2	X	-	-	-	A	A	TEVN
Lard Oil	2	-	2	1	3	2	2	2	A	A	TVB
Lead											
Lead Acetate	X	X	X	2	X	2	2	2	X	A	TENB
Lead Chloride	X	-	-	2	-	-	2	2	X	-	TVNB
Lead Sulfate	X	-	-	2	X	2	2	2	X	-	TEVNB
Lime Sulphur	X	X	X	-	X	2	2	2	X	A	TEVN
Linoleic Acid	2	X	3	2	X	2	2	2	X	A	TVB
Linseed Oil	2	2	2	2	2	2	2	2	A	A	TVNB
Lubricants (Oil)	2	1	-	-	2	2	2	2	A	X	TVNB
Magnesium											
Magnesium Carbonate	2	-	-	-	-	2	2	2	X	A	TEVNB
Magnesium Chloride	X	X	2	1	-	-	-	-	X	A	TEVNB
Magnesium Hydroxide	2	2	2	1	2	2	1	1	X	A	TEVNB
Magnesium Nitrate	2	2	2	1	2	2	2	2	X	A	TEVNB
Magnesium Oxide	-	-	-	-	-	-	-	-	X	-	-
Magnesium Sulfate	2	-	2	-	-	1	2	2	X	A	TEVNB
Maleic Acid	-	2	3	2	X	-	-	2	X	A	TEV
Mercuric											
Mercuric Chloride	X	X	X	-	X	X	X	-	X	A	TEVB
Mercuric Cyanide	X	X	X	2	X	2	2	2	X	A	TEVB
Mercury	X	X	X	1	2	-	1	1	A	A	TEVNB
Methane	1	1	2	1	2	1	1	1	A	X	TEVNB
Methanol	2	2	2	1	2	2	2	2	A	A	TENB
Methyl											
Methyl Bromide	X	-	-	-	2	-	2	2	X	X	TV
Methyl Ethyl Ketone	2	2	2	2	2	2	2	2	A	X	TE
Methyl Isobutyl Ketone	2	2	2	2	2	2	2	2	A	X	T
Methyl Methacrylate	2	-	-	-	X	-	2	2	X	A	T
Methylene Chloride	-	2	2	X	2	-	-	-	A	X	T
Milk	1	X	X	1	2	X	1	1	A	A	TEVNB
Mineral Oil	2	1	-	-	2	1	1	2	A	A	TVNB
Muriatic Acid	X	-	-	1	-	X	X	X	X	A	TV
Napthalene	2	2	2	2	2	2	1	1	A	A	TV
Naptha	2	2	2	2	2	2	2	2	A	X	TVB

Technical

Ratings given are based at 70°F (21°C).



Technical

AGENT	Aluminum	Brass	Bronze	Hastelloy, C-276	Malleable Iron Carbon Steel	Monel	Stainless Steel, 304	Stainless Steel, 316	Nylon	Polypropylene	Seal Material
Nickel											
Nickel Chloride	X	X	X	-	X	2	-	-	X	A	TEVNB
Nickel Sulfate	X	X	-	2	-	-	2	2	X	A	TEVNB
Nitric											
Nitric Acid (100%)	1	X	X	2	X	X	2	-	X	X	TV
Nitric Acid (50%)	X	X	X	1	X	X	2	-	X	X	TV
Nitric Acid (30%)	X	X	X	1	X	X	1	-	X	X	TV
Nitrobenzene	1	2	2	-	2	2	2	2	A	A	T
Oils											
Castor Oil	2	2	2	1	2	1	2	2	A	A	TEVNB
Coconut Oil	2	-	2	-	3	2	2	2	A	A	TVB
Corn Oil	2	2	2	-	2	2	-	2	A	A	TVNB
Cotton Seed Oil	2	2	2	-	2	1	2	2	A	A	TVNB
Fuel Oil	2	2	2	2	2	2	2	2	A	X	TVNB
Linseed Oil	2	2	2	2	2	2	2	2	A	A	TVNB
Mineral Oil	2	1	-	-	2	1	1	2	A	A	TVNB
Silicon Oil	2	1	2	-	2	-	2	2	A	A	TEVB
Vegetable Oil	2	2	2	1	2	1	1	1	A	X	TVNB
Oleic Acid	2	3	2	2	2	1	-	1	A	X	TB
Oleum	2	X	X	-	2	X	2	2	X	X	TV
Oxalic Acid (Sat.)	2	-	2	2	X	2	X	X	X	A	TEV
Oxygen	2	2	2	-	2	2	2	2	X	X	TEVNB
Palmitic Acid (Sat.)	2	3	2	-	3	2	2	2	X	A	TVB
Paraffin	2	2	2	2	2	2	2	2	A	A	TVNB
Perchloroethylene	2	2	2	2	2	1	-	-	X	X	TV
Petrolatum	2	-	2	-	3	2	2	2	A	-	TVNB
Phenol (Carbolic Acid)	1	1	X	1	2	1	-	1	X	X	TV
Phosphoric Acid											
Phosphoric Acid (25-50%)	X	X	2	1	X	X	-	-	X	A	TEVN
Phosphoric Acid (50-85%)	X	X	X	1	X	3	-	-	X	A	TEV
Photographic Solutions	-	-	-	-	X	1	1	1	X	X	TVNB
Phthalic Anhydride	-	2	2	1	2	1	1	1	X	X	TEV
Picric Acid	1	X	X	2	X	X	2	2	X	-	TEVNB
Plating Solutions											
Brass Plating Solution	-	-	-	1	-	-	-	2	X	A	TEVNB
Cadmium Plating Solution	-	-	-	1	-	-	-	2	X	A	TEVNB
Chrome 40% Plating Solution	X	2	2	1	X	X	2	2	X	A	TEVN
Copper (Cyanide) Plating Solution	-	-	-	1	-	-	-	-	X	A	TEVNB
Gold Plating Solution	-	-	-	1	-	-	-	1	X	A	TEVNB
Iron Plating Solution	-	-	-	-	-	-	-	-	X	A	TEVB
Lead Plating Solution	-	-	-	-	-	-	1	1	X	A	TEVNB
Nickel Plating Solution	-	-	-	1	-	-	1	1	X	A	TEVNB
Silver Plating Solution	-	-	-	1	-	-	1	1	X	A	TEVNB
Tin Plating Solution	-	-	-	1	-	-	-	3	X	A	TEVNB
Zinc Plating Solution	-	-	-	1	-	-	-	-	X	A	TEVNB
Potassium											
Potassium Acetate	X	X	X	-	2	-	-	-	A	A	TEVB
Potassium Bicarbonate (30%)	X	2	-	2	2	2	1	1	A	A	TEVNB
Potassium Carbonate (50%)	X	2	X	2	2	2	1	1	A	A	TEVNB
Potassium Chlorate (30%)	2	X	X	-	2	2	2	1	X	A	TEVNB
Potassium Chloride (30%)	X	X	2	-	2	1	-	-	A	A	TEVNB
Potassium Chromate (30%)	2	2	2	2	-	2	2	2	X	A	TEVB
Potassium Cyanide Solution (30%)	X	X	X	2	2	2	2	2	X	A	TEVNB
Potassium Dichromate (30%)	1	2	2	2	2	2	1	1	X	A	TEVB
Potassium Hydroxide (90%)	X	X	X	2	-	2	X	-	X	A	TENB
Potassium Nitrate (80%)	1	2	2	2	2	2	2	2	X	A	TEVNB
Potassium Permanganate (20%)	2	2	2	1	2	2	2	2	X	A	TEVN
Potassium Sulfate (10%)	1	2	2	1	2	1	1	1	A	A	TEVNB
Propane	1	1	1	2	2	1	2	2	X	X	TVB
Propylene Gylcol	2	2	2	2	2	2	2	2	A	A	TVNB
Propylene Oxide (90%)	-	-	-	-	-	-	1	1	X	X	TE
Pyridine	2	2	2	-	2	2	2	2	A	X	T
Pyrogallic Acid	2	2	2	2	2	2	2	2	X	X	TVNB
Silver Nitrate	X	X	X	-	X	X	2	1	X	A	TEVNB
Soap Solutions	2	2	2	1	2	2	2	2	A	A	TEVNB

Ratings given are based at 70°F (21°C).

AGENT	Aluminum	Brass	Bronze	Hastelloy, C-276	Malleable Iron Carbon Steel	Monel	Stainless Steel, 304	Stainless Steel, 316	Nylon	Polypropylene	Seal Material
Sodium											
Sodium Acetate	1	2	2	-	X	2	2	2	A	A	TEN
Sodium Bicarbonate (20%)	2	2	2	1	3	1	1	1	A	A	TEVNB
Sodium Bisulfate	X	-	2	2	2	-	-	-	A	A	TEVNB
Sodium Bisulfite	X	2	X	2	X	-	-	-	A	A	TEVNB
Sodium Borate	2	2	2	2	3	2	2	2	A	A	TEVNB
Sodium Perborate (10%)	2	X	2	2	2	2	2	2	X	A	TEVNB
Sodium Carbonate	X	2	-	2	2	1	-	2	A	A	TEVNB
Sodium Chlorate (50%)	2	2	2	1	X	1	2	2	X	A	TEVNB
Sodium Cyanide	X	X	X	2	2	X	-	-	A	A	TEVNB
Sodium Dichromate	2	X	X	1	2	-	2	2	X	A	TE
Sodium Hydroxide (70%)	X	X	X	1	3	1	2	2	X	A	TENB
Sodium Hydroxide (50%)	X	X	3	1	3	1	1	-	X	A	TENB
Sodium Hydroxide (30%)	X	2	3	2	2	1	1	1	X	A	TENB
Sodium Chloride (30%)	X	2	2	2	2	1	-	-	X	A	TEVNB
Sodium Hypochlorite	X	X	X	-	X	X	-	-	X	A	TEV
Sodium Metaphosphate	X	X	2	-	X	2	2	2	X	X	TEVNB
Sodium Nitrate (40%)	1	2	-	-	2	2	1	1	A	A	TENB
Sodium Perborate (10%)	2	X	2	2	2	2	2	2	X	A	TEVNB
Sodium Peroxide (10%)	2	X	X	2	2	2	2	2	X	A	TEVNB
Sodium Silicate	1	2	2	2	2	2	2	2	A	A	TEVNB
Sodium Sulfate	-	2	2	2	2	-	-	1	A	A	TEVNB
Sodium Sulfide (50%)	X	X	X	2	2	2	2	2	X	A	TEVNB
Sodium Thiosulphate	2	X	X	2	X	2	2	2	A	A	TEVNB
Stannic Chloride	X	X	X	-	X	X	X	X	X	A	TEVNB
Stannous Chloride	X	X	X	2	X	-	X	-	X	X	TEVNB
Steam	-	-	-	-	-	-	-	-	X	-	-
Stearic Acid	2	3	2	1	3	3	2	1	A	A	TVNB
Stoddard's Solvent	2	2	2	1	2	2	2	2	X	A	TVB
Sugar Liquors (Cane)	1	2	1	-	2	2	2	2	A	A	TEVNB
Sugar Liquors (Beet)	1	2	1	-	2	1	1	1	A	A	TEVNB
Sulfate Liquors	2	X	X	2	3	2	-	2	X	A	TVNB
Sulfite Liquors	X	X	-	1	X	X	2	2	X	X	TVNB
Sulfur Chloride	X	-	X	2	X	X	-	-	X	X	TV
Sulfur Dioxide (Dry)	2	2	2	2	1	2	-	2	X	A	TE
Sulfur Trioxide	2	2	X	2	2	2	-	2	X	X	TEV
Sulfuric Acid (TO 10%)	X	2	X	1	X	X	X	X	X	A	TEVNB
Sulfuric Acid (100%)	X	X	X	1	2	X	-	-	X	X	TV
Sulfurous Acid	2	2	X	-	X	X	X	-	X	A	TV
Tannic Acid	X	-	X	-	X	2	2	2	X	A	TEVNB
Tanning Liquors	1	-	2	1	-	-	1	1	X	A	TVNB
Tartaric Acid	-	-	2	2	-	-	1	1	A	A	TVNB
Titanium Tetrachloride	X	X	X	2	2	2	-	2	X	X	TV
Toluene	1	1	1	1	1	1	1	1	A	X	TVB
Tetrahydrofuran	X	-	2	1	1	-	1	2	A	X	T
Tomato Juice	2	-	3	2	3	2	2	2	X	A	TEVNB
Trichloroethylene	1	-	2	1	2	-	-	-	A	X	TV
Triethanolamine	2	X	2	2	2	2	2	2	A	X	TEVN
Triethylamine	-	-	-	-	-	2	2	2	A	X	TVB
Trisodium Phosphate (10%)	X	2	-	1	2	2	1	1	A	A	TVNB
Turpentine	2	X	2	2	2	1	1	1	X	X	TVB
Urea (50%)	2	-	2	-	2	2	2	2	A	A	TEVNB
Urine	-	-	-	-	2	-	1	1	X	A	TEVNB
Vinegar	X	X	2	2	2	2	2	2	X	A	TEVN
Water Acid (Mine)	X	X	X	1	X	-	-	-	X	A	TEVNB
Water (Distilled)	X	2	2	1	X	X	2	2	A	A	TEVNB
Water (Sea)	2	2	2	1	X	2	2	2	A	A	TEVNB
Whiskey	X	2	2	1	2	2	1	1	X	A	TEVNB
White Liquor (Pulp)	2	-	X	2	X	X	2	2	X	A	TEVNB
Wine	X	2	2	1	X	2	1	1	X	A	TEVNB
Xylene	2	2	2	1	2	2	2	2	A	X	TV
Zinc											
Zinc Chloride	X	X	X	2	X	-	X	2	A	A	TEVNB
Zinc Nitrate	-	-	-	-	-	-	2	2	X	A	TEVNB
Zinc Sulfate (50%)	X	2	2	2	X	2	1	1	X	A	TEVNB

Technical

Ratings given are based at 70°F (21°C).

	Page #		Page #	Page #	
Index	A	<i>Air (cont.)</i>		B	
	Adapters	Receiver manifold, ASME	G-49	Back flow preventer	E-50, I-49
	Aviation	with King™ Safety Whipsock ...	G-48	Ball	
	Bayonet style dry disconnect	with Watts filter	G-50	Cone check valves	I-28
	Bevel seat	Sharkbite® push-fit fittings	J-71, J-72	Nozzles	K-2
	Boss™	Tool lubricant	G-51	Swivel connector	
	Brass	Air Chief		with Air Chief plugs	G-23
	Pin lug	ARO	G-25	Swivels	G-162
	J-80, J-81, J-84, J-86 to	Automotive	G-23	Valves	I-2 to I-14, J-77, J-78
	J-87, J-92, J-97, J-99	Ball swivel connectors		FNPT	I-11
	Rocker lug ... J-79 to J-81, J-85, J-92	with Air Chief plugs	G-23	Socket Weld	I-11
	to J-93, J-97	Industrial	G-17, G-19	150# flanged	I-15
	Brewery hose	Lincoln	G-26	Bronze	I-2, I-3
	British instantaneous	Quick disconnect	G-17 to G-20	Band clamp	
	Cam and groove	Stainless steel	G-17 to G-20	Band and buckle	F-9
	A-3, A-35, A-50	Air King™		Set screw	F-9
	to A-52, C-40 to C-41, D-9 to D-12, D-30,	Clamps	F-20	F series	F-6
	D-54 to D-55, D-60 to D-61	Compressor Y	G-51	K series	F-7
	Compression	Ferrules	F-22, G-5	Smooth ID	F-8
	J-63	Global	F-22, G-3, G-4	Tools	F-10
	Double male	Global 4-lug	G-4	Barbed push-on fittings	E-28 to E-31,
	J-95 to J-97	Lanyards	G-6	G-23, G-24	
	Dry disconnect	Safety clip	G-6	Bayonet style dry disconnects	A-5
	A-3, A-8	Safety pin	G-6	Bell reducers	J-45
	Dry gas	Universal couplings	G-2 to G-9	Bent stem swivels	G-45
	A-10	Washers	G-6	Best Practices Safety Assessment	N-2
	Female to male	with ferrules	G-5	Bevel seat fittings	J-155 to J-159
	J-87 to J-89	with gauge port	G-5	Blow guns	
	Fill pipe	Air line		Extended nozzle	G-56
	A-40	Shut-off valves	G-87, I-29, I-30	Extensions	G-57
	Flange	Swivels	G-45, G-162	High volume	G-58, G-59
	J-45	Aluminum		Pistol grip	G-56
	Flareless bite fittings	Adapters		Premium	G-55
	J-68 to J-69	Long handle	J-108, J-110, J-117	Safety	G-58-G-59
	Forestry	Rocker lug	J-108, J-110	Safety air booster	G-55
	E-69	Cam and groove adapters	J-99	Typhoon	G-59
	E-44 to E-46	Caps	J-101	Boss-Lock™	
	A-25	Breakable	J-103	Cam and groove C-39, D-12, D-15 to	
	Grooved	Manifolds connectors	G-50	D-18, D-21 to D-25, D-27 to D-29,	
	J-47	Plugs	J-104	D-51 to D-53	
	Hydraulic	Storz		EZ Boss-Lock™	C-39, D-14, D-18,
	H-75	Adapters	J-108, J-110, J-111	D-22, D-28	
	LIQUIfit™	Bracket	J-112	Boss™	
	J-75	Caps	J-112	Adapters	C-5
	LP gas hose	Rigid	J-107, J-109	Clamps	C-10, C-11
	J-52 to J-54	Swivels	J-108, J-110	Fittings with ferrules	C-4
	Nipple	ANSI split flange adapter	J-45	Ground joint seal couplings . C-2 to C-4,	
	J-47	Anti-freeze lubricant	G-51	C-41	
	Oxy-acetylene	API		Hose menders	C-9
	M-14	Certified couplings	C-29	Male stems	C-9
	Pipe	Coupler	A-24	Spud x hose shank	C-9
	J-47	Dust cap	A-25	Washer seal couplings	C-6 to C-7
	Polycarbonate	Rack cords	A-26	Wing nut caps	C-5
	Rocker lug	Valves	A-24	Boss™ LPS	
	J-87	ARO-speed quick disconnects	G-25	Hammer union caps and plugs	C-15
	Reducing	ASME air receiver manifold	G-48 to G-50	One-piece 150# flange to weld adapters	
	J-45	Automatic		C-16	
	Rubber hose	Drain	G-84	One-piece flange adapters	C-16
	J-174	Safety couplers	G-22	One-piece hammer union nuts	C-15
	Sanitary ... J-135 to J-138, J-157, J-167,	Automotive quick disconnects	G-23	Two-piece hammer union nuts	C-15
	J-174, J-177	Aviation, dry couplings	A-11, A-12	Vent-lock™ cam & groove	D-9
	Side seal	Axe	M-11		
	A-38	Axial restraint pipe couplings	J-34		
	Single male outlet				
	J-88				
	Steam service				
	A-9				
	Tank transport				
	A-35				
	Tuff-Lite™				
	E-55, J-21				
	with grounding tab				
	A-26				
	Adjustable hose bumper stops				
	L-26				
	Aero-seal				
	F-3 to F-4				
	Agricultural				
	Bauer quick connects				
	E-62 to E-66				
	Air				
	Blow guns				
	G-55 to G-59				
	Brake fittings				
	G-137 to G-142				
	Check valves				
	I-28 to I-30				
	Couplings				
	G-2, G-4, G-7, G-8, G-10,				
	G-11, G-13 to G-16, J-52, J-53				
	Gauges, process				
	G-121				
	Hose, polyurethane				
	L-35				
	Hose reel, manual				
	L-26				
	Hose reel, retractable				
	L-25				
	Hose, self-storing				
	L-34, L-35				

	Page #		Page #		Page #
Brass		Brass (cont.)		Cam and Groove (cont.)	
Adapters		Push-on fittings E-28, E-34		90° Type A adap x female NPT	D-37
Pin lug .. J-80, J-81, J-84, J-87, J-92, J-99		Reusable fittings E-36 to E-38		90° Type B coup x male NPT .. D-38	
Rocker lug .. J-79 to J-81, J-85, J-92, J-93, J-97		Sash chains with pull rings D-51		90° Type D coup x female NPT	D-38
Ball valves I-5 to I-6		Short shank fittings E-8, E-9		90° Type E adapt x hose shank .. D-39	
Barbed hose fittings E-21 to E-28, E-32 to E-34, E-53, G-23, G-24		Sleeves J-63		90° Type F adapt x male NPT .. D-39	
Boss™		Swivels J-80, J-81, J-92		EZ Boss-Lock™	D-18, D-19, D-31, D-33, D-40, D-41, D-46
Clamps C-10 to C-11		Tees G-132, G-135, G-136, G-140, G-145, G-146, G-150, G-153, G-160, G-161		EZLink™ armless D-7	
Male stems C-8		Threaded unions J-2, J-3, J-5, J-66		Flanged couplers and adapters A-30, A-31, A-48	
Caps J-100		Water regulators G-62, G-99		Gaskets A-32, A-51, D-47 to D-51	
Caps and plugs J-103, J-105		Break-away couplings		Global C-40, D-54 to D-62	
Combination nipples E-2 to E-3		Industrial A-14		Handles D-11, D-45, D-46, D-62	
Compression fittings J-59 to J-62		Marine A-13		Jump size D-60, D-61	
Connections		Breakaway couplings		King Crimp™ system D-4	
Roof J-119 to J-121		Bevel seat J-158		Locking caps D-27	
Connectors G-131, G-133, G-136, G-137, G-143, G-149, G-151, G-159, G-160, G-161		Clamps J-143		Notched fittings .D-16, D-17, D-19, D-24	
Dies F-24		Breakaways A-14		Phono finish D-18, D-23	
Domestic J-80, J-81, J-87		TTMA A-14		Pull ring D-51	
Dual lock G-14 to G-16		Breather vents G-163		Rail car unloading assemblies A-50	
Elbows G-131, G-134, G-138, G-139, G-144, G-145, G-150, G-152, G-154, G-159, G-161		Bulkhead couplings J-25		Reducing couplers & adapters D-35, D-36, D-60	
Ferrules F-23		Bulkhead fittings J-25		Specialty items A-30	
Flare J-65 to J-67		Bull plugs J-28		Spool adapters D-34, D-60	
Gauges G-121, G-127		Bull plugs with tap J-28		Spool couplers D-34 D-60	
Hex nipples J-79, J-87 to J-89, J-95, J-97		Butterfly valves I-19, J-47		Swaged D-19, D-24	
Hex plugs J-20				Tank car fittings A-48 to A-51	
Hydrant adapters J-84, J-86		C		TTMA slip on x socket flange A-30	
Identification plates J-122		Cables		Vapor recovery couplers A-28, A-29	
Inserts J-63		King™ G-46, G-48		Velcro straps D-52	
Jack chains with S-hooks D-52		Spillguard™ armored B-6		Vent-Lock™ D-9	
Lead free fittings		Cam and groove		Weld fittings D-41, D-42	
Adapters - NPT J-3, J-7		150# flange D-40		Witches hat strainers D-51	
Close pipe nipple - NPT J-9		Actuator style A-4			
Female hex couplings - NPT J-5		Adapters A-28, A-30, A-31, A-36 to A-38, A-50, C-40, C-41, D-9, D-10, D-12, D-23 to D-25, D-30, D-34, D-40, D-54, D-58, D-60, D-64		Caps	
Male hose x male hose x female pipe E-44		Boss-Lock™ D-33, D-34, D-44, D-45		Aluminum A-34, A-35, J-101, J-103	
Pipe cap - NPT J-19		Boss™ LPS D-9		API, dust A-25	
Reducer bushings - NPT J-7		Clips and lanyards G-6		Blank end J-47	
Reducer couplers - NPT J-3		Couplers A-2, A-28, A-29, A-31, C-39, D-7, D-9, D-10, D-13 to D-18, D-19 to D-22, D-31 to D-34, D-40, D-44, D-55 to D-57, D-62, D-64 to D-66		Boss™ wing nut C-5	
Long shank fittings E-12		Coupler x tube with 45° cut D-43		Brass J-100	
LP gas hose couplings and adapters J-52 to J-53		Crimped fittings C-40, C-42 to C-45, C-47, C-51		Breakable J-103	
Male swivel inserts E-21		Crimp sleeves C-42, C-43		British instantaneous J-124	
Nickel plated push-in fittings G-149 to G-151, G-155		Disk strainers D-51		Dix-Lock™ G-12	
Nipples		Dry disconnect A-2, A-3		Dust A-39	
Double male hex J-95 to J-97		Dust caps D-8 to D-10, D-26 to D-28, D-59, D-68		Dust, cam and groove D-10, D-26 to D-28, D-59	
Female to male hex J-87 to J-89		Dust plugs D-9, D-29, D-59, D-68		Fill pipe A-42	
Nozzles		Elbows		Flat face H-56	
Fog K-11 to K-15		45° adapter x coupler D-37		Gravity drop adapters A-26	
Rack K-12		45° coupler x coupler D-37		Hammer union C-15	
Nylon/nickel-plated push-in fittings G-151, G-154		90° adapter x coupler D-37		Hydrant, iron J-103	
Plugs J-105		90° coupler x coupler D-37		Instrumentation J-58	
Push-in fittings G-143 to G-148				Lockable D-27	

	Page #		Page #		Page #
Caps (cont.)				Couplings (cont.)	
Thermoplastic	J-102	Compression fittings	J-59 to J-64	Booster hose	E-68
Universal hose	J-102	Compressor Y valve	G-51	High density polyethylene	J-50
Vacuum relief	A-41	Conical mufflers/filters	G-163	Lightweight flexible	J-40
Vapor	A-41	Connections	I-61	Lite®	J-41
Vent	A-42	International shore	J-125	Quick release	J-38
Carded FRL's	G-90	Roof	J-119 to J-121	Rigid	J-42
Check valves		Single hydrant	I-61	Standard	J-39
800 PSI stainless steel	I-29	Single inlet	I-61	Straub	J-34, J-35
Ball cone	I-28	Single inlet residential sprinkler	I-61	Crimp	
In-line	G-157, G-158	Connectors, push-in	G-131 to G-133, G-143 to G-147, G-149, G-153, G-155	Collars	H-79
Spring loaded	I-29, I-30	Constant torque clamps	F-5	Crimped fittings	
Swing	I-30	Continuous spring guard	L-42	Cam and groove	C-40, C-42 to C-45, C-51
TrueSeal™	J-78	Contractor pressure gauges	G-123	Sanitary	C-36
Uni-directional	G-158	Corrosion resistance of coupling material	N-10 to N-14	DIN external crimp stem	C-37
Chicago type fittings	F-20, F-22, G-2 to G-6, G-46, G-49	Couplers		True ID	H-78, H-79, L-38
Clamps	F-2 to F-6, F-8, F-12 to F-20, H-80, H-81	API	A-24	Crimping tools	F-25, F-26
3 segment	J-131	Bayonet style dry disconnect	A-5	Cross	
Accessories	F-10	Legris	G-22	Schedule 80 polypropylene	J-23
Aero-Seal®	F-3, F-4	Parker E-z-mate	G-21	Crows foot type fittings	G-2 to G-5
Air King™	F-20	Quick connect	G-19, G-20, G-25, G-26		
Band	F-6	with grounding tab	A-26	D	
Bolted	F-15 to F-19	Couplings		Desiccant dryer, FRL	G-70
Boss™	C-10, C-11	Air King™ universal	G-2	Diameter tape	M-9
Center punch	F-6, F-8	A-series	G-42	Differential pressure indicator	G-86
Constant torque	F-5	Bayonet style dry disconnect	A-5	Digital gauges	G-128
Dairy	J-132	BR-series	G-41	DIN fittings	J-151, J-154
Double bolt	F-18	Cam and groove	A-2 to A-4, A-28, A-29, A-31, A-38 to A-39, C-39, C-40, D-9, D-10, D-13 to D-18, D-20 to D-22, D-31, D-55 to D-57, D-60, D-62	Disk strainers	D-51
HTM hi torque	F-5	CJ-series	G-36	Display, FRL	G-89, G-90
Hydraulic	H-76	DF-series	G-27, G-28, G-31	Dix-Lock™	
Kits	F-14	Dix-Lock™ quick acting	G-10 to G-13	Cap	G-12
Painted iron	J-43	Dry quick disconnects	A-13 to A-23	Converter	G-12
Pinch-on	F-12	D-series	G-28, G-29, G-31	Quick acting couplings	G-10 to G-13
Racks	F-14	Dual lock quick-acting	G-14 to G-16	D.O.T.	
Sanitary	J-130 to J-132, J-160	Equipment	C-17, C-31	Air brake tubing	L-31
Sanitary accessories	J-132	F-series	G-28 to G-31	Push-in fittings	G-131 to G-142
Service kit	F-13	Global Air King™ quick-acting	G-4	Double	
Single bolt	F-19	Global Air King™ universal	G-3	Bolt clamps	F-18
Smooth ID	F-8	Ground joint	C-12	Drip leg auto drain	G-106
Spiral	F-20	Insertor	M-4	Drum	I-87, I-88
Stepless ear	F-13	J-series	G-32	Faucets	I-87
T-bolt	F-15, F-16, J-131	Long shank	E-11, E-12	Gate valves	I-88
Toggle	J-131	LP gas hose	J-52 to J-54	Plug wrenches	I-87
Tools	F-10, F-13	L-series	G-38	Thread adapters	I-88
Wave seal	F-4	Lubricant	M-8	Dry	
Worm gear	F-2, F-14	M-series	G-34	Aviation	A-11, A-12
Marine grade	F-3	NK-series	G-40	Gas	A-10
Worm gear racks	F-14	N-Series	G-10 to G-13	Gauges	G-119 to G-122
Claw type fittings	G-2 to G-5	Pump hose	C-31	Quick disconnects	A-5, A-8
Close nipples	J-10	Safety break-away	A-13, A-14	Dryers	
Coil-Chief	L-34	Sand blast	G-7	Desiccant air	G-70
Combination nipples	C-47 to C-49, E-2 to E-4, E-6	SHD-series	G-37	Dry hydrant	
Global	E-4	Short shank	E-8 to E-10, E-52, E-55	Low level strainer	J-127
Sleeves	F-21	Spray hose	E-14, E-43	Strainers	J-126 to J-131
Combination units		Steam service	A-9	Dual Lock™	
Series 1	G-92, G-105	Surelock™ quick acting	G-8	Gaskets	G-16
Watts	G-116	Threaded both ends	J-4	Locking key	G-16
Wilkerson	G-64, G-79 to G-83	U-series	G-39	Quick-acting couplings	G-14 to G-16
Composite mini ball valves	G-156			Dust caps	A-39
Compound gauges	G-124				

<i>Dust caps (cont.)</i>	Page #	<i>Elbows (cont.)</i>	Page #	Page #
AG-series	H-27	Street	J-13, J-14	Index
Cam and groove	D-10, D-26, D-27, D-28, D-59	Suction	J-117	
CVV-series	H-54	Threaded	J-13	
Dry gas	A-10	reducing	J-17	
Gravity drop adapters	A-26	side outlet	J-15	
H-series	H-6	Threaded, 45°	J-15	
HT-series	H-11	Street	J-15	
K-series	H-25	Threaded, 90°	J-12, J-14, J-23	
PD-series	H-32	Threaded side outlet	J-17	
ST-series	H-35	Tuff-Lite™	E-53, E-56	
Threaded	A-5, J-24	Equipment		
T-series	H-51	Clamp tools	F-11, F-13	
VEP-series	H-48	Coupling inserters	M-4	
V-series	H-21	Crimpers	F-25, F-26	
W-series	H-42	Cutters	L-36	
WS-series	H-45	For push-on fittings	E-35	
Dust plugs	A-5, A-39, J-54	Test pumps	M-5	
AG-series	H-27	Exhaust muffler		
Aviation	A-11	Wilkerson	G-83	
Cam and groove	D-29, D-59	Expansion ring couplings ..	E-67, E-68, E-70	
CVV-series	H-54	Expansion unit assembly	E-67, E-68	
Dry quick disconnect	A-7	External crimp ferrules	C-44, C-45	
H-series	H-6	External drain cocks	I-24	
HT-series	H-11	Externally swaged fittings ..	C-19 to C-24, E-6	
K-series	H-25	EZ Boss-Lock™	C-39, D-9, D-14, D-18, D-22, D-28	
ST-series	H-35	EZLink™	D-7	
T-series	H-51	Bottle opener	D-8	
VEP-series	H-48	Dust caps	D-8	
V-series	H-21	Replacement gaskets	D-8	
W-series	H-42	Replacement kits	D-8	
WS-series	H-45	Safety clip	D-8	
E		F		
Elbows		Faucets	I-87	
Air brake	G-138, G-139	Compression bibb	I-87	
Angle	J-117	Ferrule crimping tools	F-25, F-26	
Bevel seat	J-158	Ferrules		
Coaxial	A-37	Air King™	G-5	
Compression	J-61, J-62	Bevel seat	J-156, J-157	
Continuous swivel	J-117	Brass	F-23	
Drop	A-25, A-36 to A-38	Clamp	J-133, J-134	
Flare	J-66, J-67	Crimped, sanitary	C-37	
Flareless bite fittings	J-68 to J-70	Externally swaged	F-22	
Grooved	J-46	Global Air King™	F-22	
Hydraulic	H-55, H-56, H-61 to H-62, H-63, H-65, H-66, H-68, H-69	I-line	J-161	
Instrumentation	J-56, J-57	Instrumentation	J-58	
LIQUIfit™	J-73 to J-77	Internally expanded	C-26	
Nickel plated	G-149	King Crimp™	C-44, C-45	
Nylon	E-53, E-56	Heavy duty	C-51	
Polypropylene	E-56	Short frac	C-14, C-49	
Push-in ... G-131, G-134, G-135, G-144, G-148, G-150, G-152, G-154, G-159, G-161		Notched	F-22	
Sanitary	J-138, J-139, J-158, J-170, J-171, J-172, J-176, J-177, J-191, J-192	Oxy-acetylene	M-14	
Sharkbite®	J-72	Petroleum	C-30	
Storz	J-110	Pipe size	J-165	
		Quick weld	J-143	
		Fill pipe		
		Adapter caps	A-42	
		Adapters	A-40	
		Filter/Regulators		
		Accessories	G-106 to G-111, G-117, G-118	
		Carded	G-90	
		FRL	G-62, G-63, G-75, G-99, G-100, G-113	
		Mini's	G-62, G-63	
		Series 1	G-99, G-100	
		Watts	G-113, G-114	
		Filters		
		Accessories	G-85 to G-89, G-106, G-107, G-117	
		Airline	G-65, G-66, G-92 to G-94	
		Carded	G-90	
		Disposable in-line nipple	G-53	
		Hydraulic		
		In-line	H-76	
		In-line, air/oil	G-52	
		Lubricator	G-53	
		Mini in-line	G-53, G-54	
		Oil removal	G-94	
		Watts	G-112	
		Wilkerson	G-61, G-69	
		Filters, regulators, lubricators ..	G-52 to G-54, G-61 to G-120	
		Filters / strainers		
		Wire cloth mesh over screens	J-188	
		Finger type clamps	C-10, C-11	
		Fire hose		
		Adapters	D-63, D-67, J-79, J-80, J-82 to J-87, J-90 to J-92, J-94, J-96, J-97	
		Pin lug ..	J-80, J-81, J-84, J-86, J-87, J-92, J-97, J-99	
		Rocker lug ..	J-79 to J-83, J-85, J-87, J-90 to J-94, J-97, J-98, J-108, J-110	
		Axe	M-11	
		British instantaneous fittings	J-123, J-124	
		Cabinet	L-24	
		Cam and groove	J-99	
		Caps	J-100 to J-103	
		Pin lug	J-100	
		Rocker lug	J-100	
		Cap test gauges	J-104	
		Connections	J-119 to J-121, J-125	
		Couplings	E-67, E-68	
		Elbows	J-117	
		Storz	J-110	
		Flange	J-110	
		Gaskets	K-13	
		Gauges	M-7	
		Hose	L-2 to L-16, L-3 to L-17	
		Forestry non weeping	L-14	
		Hose couplings	E-67, E-68	
		Hydrant		
		Caps	J-102, J-103	
		Wrenches	J-113 to J-115	
		Hydrants		
		Adapters	D-63, D-67	

	Page #		Page #		Page #
Fire Hose (cont.)		Flomax Connectors (cont.)			
Jacket	L-41	R series	A-20, A-23	Grease whip assemblies	M-12, M-13
Monitor	K-23	Service box	A-17	Grip-L couplings	J-34
Nipples	J-87 to J-89, J-95	Standard	A-18, A-23	Grooved couplings	J-43, J-46, J-47
Nozzles	K-11 to K-24	Flow chief food grade fittings ..	C-35 to C-37	Grooved fittings	
Pin rack	L-23	Flow control valves		End caps	J-47
Plugs	J-104, J-105	Legris	G-156, G-157	Lightweight	J-40
Pin lug	J-105	Fog nozzles	K-15	Mechanical tees	J-44
Rocker lug	J-105	Food grade fittings	J-130 to J-197	Nuts and bolts	J-49
Pump test headers	J-118	Foot valves	E-18	Quick release	J-38
Rack	K-12, L-12, L-13, L-23	Frac	C-13, C-14, C-16	Rigid	J-42
Reels	L-18 to L-21	FRL's		Series 45	J-46
Replacement swivel	J-106	Accessories	G-85 to G-88, G-106 to G-108, G-117, G-118	Series 90	J-46
Round identification plates	J-122	Carded	G-90	Series AN	J-47
Single jacket 500#	L-10	Combination units ..	G-64, G-79 to G-82	Series BE	J-47
Spanner wrenches ..	E-11, J-113 to J-116	Displays	G-89, G-90	Series EC	J-47
Sprinkler line tester	M-7	Series 1	G-54 to G-111	Series FA	J-45
Storz	J-107 to J-113, J-116, J-127 to J-129	Watts	G-112 to G-118	Series RA	J-45
Strainers	J-127 to J-129	Wilkerson	G-61 to G-89	Series SF	J-45
Suction	J-79, J-93, J-115, J-117	Fuel nozzles	A-15, A-16, K-7 to K-11	Series T	J-44, J-46
Swivels ..	E-71, I-41, J-80 to J-83, J-92, J-94, J-106, J-108, J-110, J-117, J-127	Fuel receivers	A-15, A-16	Standard	J-39
Tank	J-129			Grooved nipples	J-47
Washers	E-71			Grooved stem style ext. crimp ferrule	C-44 to C-45
Wrenches	J-113 to J-116			Grooved valves	J-47
Fire jacket for hose	L-41	G		Groove lube	J-49
Fire tape	L-41	Garden hose		Ground joint	
Flame retardant hose and cable protection ..	L-39	Adapters	E-44 to 46, J-8, J-11	Fittings	C-2 to C-4, C-12, C-41
Flange		Back flow preventer	E-50		
ANSI flat face	J-37	Compression bibb faucets	E-48	H	
Code 61 / code 62 hydraulic		Country Club® RT	L-29	Hammer unions	J-29 to J-31
Split flange kit	H-75	Coupler	E-49	Caps	C-15
Floating	C-48	Fittings	E-50	One-piece nut	C-15
Gaskets	A-32	GHT zinc hose	E-44	Plugs	C-15
Slip-on	A-30	Hex nut with knurl	E-47	Two-piece nut	C-15
Tube OD wall	J-190	Hot water rubber reinforced	L-28	Handles, cam and groove	D-62
Tube OD weld	J-181	Lok-on hose fittings		Hangers	
Flanged		Caps	E-35	Pipe	J-168
Adapters	C-16, J-37, J-45	Marine, camper, patio & pool	L-29	Tube	J-189, J-190
Combination nipple	C-48	Perfect water	L-28	Hex bushings	J-6
Dry aviation	A-12	Premium rubber	L-27	Hex manifolds	G-51
Dry break	A-3	Quick connectors	E-48	Hex plugs, brass	J-20
Dry quick disconnect	A-7, A-8	Round nut with knurl	E-47	Holedall™	
Quick-connect, fittings	E-58 to E-66	Rubber vinyl	L-27	Couplings	C-22, C-27, C-29
Storz	J-110	Shank fittings	E-39 to E-42	DIN external crimp stem	C-37
Tee	A-30	Top level PVC	L-28	Expander machine	C-31
Weld adapters	C-16	Valves	E-49	Female end	C-22
Flanges	J-36, J-37	Gas		Ferrules ..	C-26, C-28, C-30, C-35, C-37
Hydraulic		Dry couplings	A-10	Nipples	C-20, C-21
Pipe socket weld	H-74	Regulators	G-98	Petroleum	C-29 to C-31
Flare fittings	J-65 to J-67	Gaskets	A-32, A-34, A-51, C-31, E-15, E-68, G-16, J-25, J-26, J-37, J-43, J-45, D-48, D-49, D-50, J-48, J-53, J-112, J-144 to J-149, J-151, J-152, J-154, J-159, J-163, J-164, J-169	Swaging machines	C-17
Flareless bite fittings	J-68	Gauges	G-60, G-86, G-119 to G-128, J-186, M-7	Hookie - hook hose lifter	J-31
Flat face fittings	H-55	Line test	M-7	Horizontal swing check valves	I-30
Flexogen®, garden hose	L-27	PITOT	M-7	Hose	
Flexzilla®, garden hose	L-28	Sprinkler system	M-7	300# single jacket	L-9
Flomax connectors		Three way	M-7	500# single jacket	L-11
¾" series	A-22	Gravity drop adapters	A-25	500# single Jacket	L-10
Diesel fueling system	A-15	Dust caps	A-26	800# double jacket	L-11
Fuel vent	A-15, A-17			Air, self-storing	L-34, L-35
Gravity fill receiver	A-17			Braided rubber	L-8
High flow 1" series	A-22				

	Page #
<i>Hose (cont.)</i>	
Bumper stops	L-26
Cabinet	L-24
Chemical	L-16
Contractors	L-27
Crimper	F-26, F-27
Cutters	L-36
Diameter tape	M-9
Fire	L-2 to L-15
Fire jacket for hose	L-41
Fittings, barbed	E-21, E-34, G-23, G-24
Flexogen®	L-27
Flexzilla®	L-28
Hand crank reel	L-8
Hot water reinforced	L-28
Hot water washdown	L-8
Hydrostatic test pumps	M-5
Hydrotest pump	M-5
Knife	M-9
Mallet	M-9
Menders ...	C-9, E-19, E-20, E-54, E-57
Mill	L-2 to L-5
MSHA approved	L-12
Nitrile	L-6 to L-8, L-13, L-15
Nominal smooth bore	L-37
Non-collapsible	L-17
Potable water	L-12
Rack	L-13, L-23
Racks	L-22
Reels	L-21 to L-25, L-25, L-26
Room equipment	M-9
Spiral protection	L-39
Spray couplings	E-14, E-43
Storage	L-24
Swivels	G-5, G-45, G-162, H-77
True ID	L-38
Hose assembly tool	E-35
Hose couplings	
Booster	E-68
Expansion rings	E-70
Hose coupling workshops	N-2
Hot water washdown hose	L-8
Hydrant	
Adapters	J-84 to J-87
Caps	J-102, J-103
Wrenches	J-113 to J-115
Hydrant body	I-57
Concealed two way wall	I-57
Hydraulic	
Adapters	H-75
AG-series	H-26, H-27
BSPP fittings	H-72
Clamps	F-19
CM-series	H-28
Code 61 / 62 flanges	H-73
Code 61 / code 62 flange adapters	H-75
CVV-series	H-53
EA-series	H-40
E-series	H-38, H-39
E-Series	H-37
Filter	H-76
Flat face fittings	H-55
H-BOP-series	H-36

	Page #
<i>Hydraulic (cont.)</i>	
H-series	H-2 to H-5, H-7, H-8
HS-series	H-14
HTE-series	H-13
HT-series	H-9, H-10, H-11
K-series	H-24, H-25
Metric fittings	H-71
NPTF fittings	H-67, H-68
PD-series	H-32
Return line	H-76
Split flange kit	H-75
ST-series	H-33 to H-35
TR-series	H-52
T-series	H-50, H-51
Valves	
High pressure ball	I-14
VEP-BOP series	H-49
VEP-series	H-47, H-48
V-series	H-15 to H-20, H-22, H-23
WS-BOP series	H-46
W-series	H-41 to H-43
WS-series	H-44, H-45
I	
I-line fittings	J-160 to J-162, J-183
Industrial	
Internally expanded fittings ..	C-25, C-26
Quick connects	G-17, G-21, G-22
Safety break-away	A-14
Industrial fluid controls	
ADS	B-2
Outalarms™	B-2
Gauge rods	B-4
Open dome adapter	B-3
Outage gauge	B-3
with capacitance probe	B-2
with high temp. capacitance probe ..	B-3
Spillguard™ monitors	
Armored cables	B-6
Probes	B-6
Spillguard™ monitors	B-5
In-line	
Check valves	G-158
Desiccant dryers	G-70
Filter, air	G-52 to G-54, G-162
Filter, mini	G-54
Flow control	G-156, G-157
Lubricators	G-52, G-53
Swivels	G-162
In-line sight glass	D-43
Instrumentation fittings	J-55 to J-58
Interlocking clamps	C-10, C-11, F-20
J	
JIC fittings	E-32, E-33, H-60, H-61, H-64 to H-65, H-66, H-77
Joint sealant gasket material	M-3

	Page #
K	
Kevlar®	
Sleeves	L-40
King™	
BSPT end	E-5
Cables	G-46
Straps	G-47
Cam and groove	C-40
Adapters	C-41
Couplers	C-40
Combination nipples	C-47 to C-50, E-2 to E-4, E-6
Global	E-4
Sleeves	F-21
Crimp style	C-36, E-4, E-6 to E-9, E-11, E-20
150# ASA fixed (welded) flange	C-48
Adapters	C-41
Combination nipples	C-47
Combination nipples and sleeves	C-49
Ferrules	C-44, C-45
Global cam and groove	C-40
Nipples for floating flanges	C-48
Short frac ferrules	C-14, C-49
Sleeves	C-42, C-43
TTMA flange x King Crimp™	C-48
Ferrules	C-44, C-45
Heavy duty	C-51
Flanged	C-48, E-4
Floating flange	C-48
Frac	C-14, C-16
Hose menders	E-20
PF shank	E-6
Plastic pipe	E-5
Quick-acting	G-4
Shank couplings	E-8, E-9, E-11
Sleeves	C-42, C-43
Short	C-49
L	
Lanyards	D-53
Leak detector	M-3
Legris fittings	G-147, G-149, G-151, G-154 to G-159
Legris tubing	L-33
Lever external drains	I-24
Limit switches	I-86
Lincoln interchange quick disconnects ..	G-26
Line strainer	J-51, K-35
LIQUIfit™ fittings	J-73 to J-76
Lockable caps	D-27
Locking ball valves	I-3, I-4, I-9, I-10
Locking kit, dry disconnect	A-2
Lok-on fittings	
Caps	E-35
Long shank couplings	E-11, E-12

	Page #		Page #		Page #	
Index	LP			N		
	Boss™ male stems	C-9, H-76			Nipples	
	Gas hose coupling & adapters	J-52 to J-54			3500	G-44
	Metal acme caps	J-54			Brass female to male	J-87 to J-88, J-89
	Plastic acme caps	J-54			Brass male hex	J-95, J-97
	Plastic dust plugs	J-54			Close	J-10, J-22
	Wrench	J-53			Combination	E-2 to E-4, E-6
	Lubricants				Filters	G-53
	Air tool	G-51			hex	
	Anti-freeze	G-51			reducer	J-10
	Lubricators				straight	J-10
	Accessories	G-109 to G-111, G-118			Hex	E-7, J-10
	Carded	G-90			Hex welding	J-32
	EconOmist® compact	G-77			King™	E-4, E-6, E-7
	EconOmist® standard	G-77 to G-79			Notched turned back	E-5
	In-line	G-52, G-53			Octagon	J-32
	Mini	G-63			Pipe	J-8, J-32
	Series 1	G-101 to G-105			Polypropylene	J-22
	Micro-fog	G-101 to G-103			Swage	J-27
	Oil-fog	G-104			Nitrile washdown hose	L-6 to L-8
	Watts	G-115			Northline	J-98
	Wilkerson	G-63, G-77 to G-79			Notched	
					Cam and groove fittings	D-16, D-17, D-24
					Stems, Holedall™	E-6
					Turned back nipples	E-5
					Nozzle accessories	
					Multi-plane hose swivels	K-6
					Single plane hose swivels	K-6
					Nozzles	K-35
					Adjust-A-Power	K-30
					Ball	K-2
					Ball shut-off	K-17, K-19, K-20, K-22
					Break apart attack	K-16
					Constant flow	K-16, K-30
					Displays	K-30
					Constant Flow	K-30
					Dual gallonage	K-18
					Econo fog	K-15
					Electrical fire	K-11, K-13
					Fog	K-11 to K-16, K-18, K-19, K-21
			Forestry	K-18 to K-20		
			Fuel	K-2 to K-4, K-10		
			Garden hose	K-15		
			Holders	G-7		
			Industrial	K-11		
			Industrial grade	K-27		
			Injector	K-35		
			Master stream	K-23		
			Overwing aircraft	K-4		
			Penetrator	K-20		
			Pistol grip	K-19		
			Pistol grip adapters	K-17		
			Plain hose	K-22, K-24		
			Pressure	A-41, K-3, K-4		
			Pressure washing			
			Fixed quick coupling plugs	K-35		
			Line strainer	K-35		
			Nozzle holders	K-38		
			Quick connect nozzles	K-36		
			Spray guns	K-32		
			Nozzles (cont.)			
			Anti-fatigue	K-32		
			Kit with hose, nozzle & lance	K-32		
			Lances and extensions	K-33, K-34		
			Pressure	K-32		
			Spray nozzles	K-36		
			Swiveling quick couplings	K-34		
			Turbo nozzles	K-38		
			Inlet filter	K-38		
			Valves	K-39, K-40		
			Balance release	K-40		
			Safety release	K-39		
			Thermal relief	K-39		
			Unloader	K-39		
			Water broom	K-40		
			Rack	K-12		
			Refinery	K-14		
			Selectable gallonage	K-18		
			Adjustable Tri-Flo	K-18		
			Shut-off	K-17, K-19, K-20		
			Single gallonage	K-18		
			Spray	K-25 to K-28		
			Hot water washdown	K-25		
			Street cleaning	K-24		
			Sweeper	K-29		
			Temperature indicating	K-27		
			Tips	K-22		
			TriFlow	K-15		
			Twin tip straight stream	K-20		
			Twist	K-29		
			U.S. Coast Guard approved	K-21		
			Utility	K-3		
			Washdown	K-25 to K-30		
			Elevated temperature	K-28		
			Hot water	K-25		
			Industrial	K-27, K-28		
			Wand	K-26		
			Water	K-29		
			Insulated	K-29		
			Pistol-grip	K-29		
			Power flow	K-29		
			Water, flexible	K-29		
			NPT threaded fittings	J-6 to J-19, J-32		
			NYFD	I-31, I-35		
			Nylon fittings	J-21 to J-24, J-73 to J-76		
			Nylon protective sleeve	L-40		
			Nylon tubing	L-32		
			O			
			Octagonal nipples	J-33		
			Oil removal filter	G-94		
			Oil spill kits	M-8		
			Oil vapor removal filter	G-95		
			Open flex 1L couplings	J-35		
			Oxy-acetylene			
			Connecting spuds	M-14		
			Ferrules	M-14		
			Hose couplings	M-14		

	Page #		Page #		Page #
P		<i>Pneumatic (cont.)</i>			
Panel builder gauges	G-123	P-series	G-14 to G-16	Railroad tank car	
Parker Ez-Mate	G-21	SHD-series	G-37	Fittings	A-48, A-49
Petroleum fittings, API	C-29	U-series	G-39	Gaskets	A-51
Petroleum fittings, Holedall™	C-27 to C-30	Polished fittings		Reducer	
Phonograph finish fittings	E-6	Elbows, sweep	J-172	Bell	J-45
Pinch-on clamps		Polycarbonate		Combination nipples	E-4
Double ear	F-12	Hydrant adapters	J-87	Sanitary	J-141, J-158, J-174, J-179, J-194, J-195
Single ear	F-12	Polyethylene tubing	L-32	Tuff-Lite	E-52
Pin lug		Polypropylene		Reels	
Couplings	A-35, A-48 to A-50, E-8, E-9	Ball valves	J-51	Hand crank	L-8
Pipe		Bolted fittings	J-26	Reelcraft® hose	L-25, L-26
Adapters	J-47	Pipe fittings	J-21 to J-24	Reelcraft® static discharge	A-39
Caps	A-34	Sleeves	J-189	Reels, hose	
Couplings	J-39 to J-41, J-50 to J-52	Polyurethane		Continuous flow	L-20, L-21
Grip-L	J-34	Air hose	L-35	Swing type	L-19
Open-Flex 1L	J-35	Tubing	L-32, L-33	Heavy duty	L-19
Cross	J-18, J-23	Positioners	I-86	Pipe brackets	L-19
Crosses	J-18	Pressure recommendations	N-4 to N-9	V swing	L-18
Hangers	J-168	Pressure restricting	I-47	Regulators	
Nipples	J-8, J-9	Adjustable	I-47	Accessories	G-86 to G-89, G-108, G-118
Play pipes	K-24	Angle valves	I-48	Carded	G-90
Tips	K-24	Probes	B-2, B-3, B-6	Dial air	G-70
Plugs	A-5	Process gauges	G-121	Gas	G-98
Adjust-a-plug	J-104	PTFE		High flow	G-73, G-74
Aluminum	J-104	Gaskets	A-34	High pressure	G-71, G-72
Ball swivel	G-23	Hose		Manifold	G-98
Brass	J-105	Fittings	H-78	Mini general purpose	G-54
British instantaneous	J-124	Insertion tool and dies	H-77	Mini water	G-62, G-98
Bull	J-28	Sealant	M-3	Series 1	G-96 to G-99
Bull with tap	J-28	Tape	M-2	Water	G-99
Compression	J-63	Pump adapters	J-7, J-25, J-95	Watts	G-113, G-114
Dust, cam and groove	D-29, D-59	Punch style clamps	F-6 to F-8	Wilkerson	G-61 to G-63, G-70 to G-75
FDC	J-104	Push-in fitting kit	G-155	Replacement handles	
Hammer union	C-15	Push-in fittings	G-131 to G-133, G-143 to G-147, G-149, G-153, G-155	Cam and groove	D-62
Hex head	J-20, J-24	Push-on fittings	E-28, E-34, E-57		
Hydraulic flat face	H-56	Push to connect fittings	J-71, J-72		
Instrumentation	J-58	PVC tubing	L-30		
LIQUIfit™	J-75				
LP gas	J-54				
Push-in fittings	G-154, G-161	Q		S	
Quick-connect	G-17, G-18, G-23, G-25, G-26	Quick-acting couplings	G-4, G-8, G-10 to G-16	SAE fittings	E-34, F-2, F-5, F-14, H-55, H-57 to H-59, H-75
Square head	J-20, J-24	Quick connect		Safety	N-3
with pull handle	A-39	Air fittings	G-4, G-8, G-10 to G-43	Be safe	N-3
Pneumatic		Quick-connect		Blow gun	G-55
Air Chief ARO	G-25	Agri-Lock style	E-58 to E-61	Break-away couplings	A-13, A-14
Air Chief automotive	G-23	Quick release couplings	J-38	Cables	G-48
Air Chief industrial	G-17, G-19	Quick weld ferrules	J-143	Shackles	G-48
Air Chief lincoln	G-26			Check Valves	I-26
A-series	G-42			Clips and lanyards	D-52, D-62
BR-series	G-41			Locking pin	G-9
CJ-series	G-36			Pop-Off Valves	I-27
DF-series	G-27, G-28, G-31			S.T.A.M.P.E.D.	N-3
D-series	G-28, G-29, G-31			Tape and tag	M-10
F-series	G-28 to G-31			Vented ball valves	I-4
J-series	G-32			Whipsock	G-48
L-series	G-38			Sand blast couplings	G-7
M-series	G-34			Sanitary	
NK-series	G-40			Adapters	J-135 to J-138, J-157, J-167, J-174, J-177
N-series	G-10 to G-13				
		R			
		Racks			
		Fire hose	L-23		
		Hose	L-22		
		Worm gear clamp	F-14		
		Radiator bibb	E-50		
		Railcar unloading assemblies	A-31, A-33, A-48 to A-51		

Index



	Page #		Page #		Page #
Sanitary (cont.)				Stainless steel (cont.)	
Bevel seat fittings	J-139, J-155 to J-159, J-170	Sharkbite® push to connect fittings	J-71, J-72	Ferrules	C-24, J-58
Biopharm fittings ..	J-191 to J-194, J-196	Shore connections	J-125	Gate valves	I-17
Bolted clamps	J-131, J-160	Short shanks	E-8 to E-10, E-52, E-55	Gauges	G-120, G-123, G-125, G-126
Breakaway couplings	J-143, J-158	Shut-off		GHT adapters	E-44 to E-46
Caps J-135, J-152, J-153, J-157, J-162, J-166, J-177, J-183, J-196		Valves	G-87, I-29	Hose swivels	K-5
Clamp accessories	J-132	Siamese assemblies	I-59, I-60	Inserts	G-141
Clamp fittings	J-130 to J-150, J-165, J-167, J-170, J-171, J-186, J-191 to J-195	Double clapper concealed type	I-60	Lockable ball valves	I-9, I-10
Clamps	J-130 to J-132, J-160	Two way sidewalk	I-60	Menders	E-19
Crosses	J-141	Wall plate for double clapper	I-59	Notched shank cam and groove ...	D-16, D-17, D-24
DIN fittings	J-151, J-154	Siamese body	I-56	Pipe hangers	J-168
Elbows	J-138, J-139, J-158, J-170 to J-172, J-176, J-177, J-191, J-192	Reversible concealed angle	I-56	Push-in	G-147
European fittings	J-151 to J-154	Reversible concealed angle UL	I-56	Quick couplings	G-17 to G-21
Ferrules	J-133, J-134, J-143, J-156, J-157, J-161, J-162, J-165, J-166	Siamese connections	I-53 to I-55	Short shank couplings	E-10
Filters	J-188	Double clapper	I-54	Spray balls	J-182 to J-183
Flanges	J-181, J-190	Single clapper	I-53	Strainers	E-16, E-17
Gaskets	J-144 to J-149	Triple clapper	I-55	Swaged fittings	D-19, D-24
Gauges	J-186	Side-entry filter/strainer	J-187	Thermometers	G-129
I-line fittings	J-160 to J-164	Side-outlet reverse strainer	J-187	Threaded fittings	J-6 to J-12
Laterals	J-142, J-175	Sight flow indicators	A-32, A-33, A-52	Thread tape	M-2
Nuts ..	J-132, J-152, J-153, J-155, J-190	Flanged acrylic	A-33	Tube hangers	J-189 to J-190
Pipe hangers	J-168	Repair kits	A-33	Steam	
Quick weld ferrules	J-143	TTMA pattern	A-33	Gauge siphon	G-128
Reducers	J-141, J-158, J-174, J-179, J-194, J-195	Sight glasses	J-183, J-184	Hose couplings	A-9
Sight glasses	J-183, J-184	Single bolt clamps	F-19	Valve, 250 lb.	I-4
Spray balls	J-182	Skimmers	E-17	Storz	
Strainers	J-187, J-188	Sleeves	C-42, C-43, C-49, F-21, G-140, G-142, J-168, J-189	Accessories	J-112
Swivels	J-185	Sleeving	L-40	Adapters	J-107, J-108, J-111
Tees ..	J-140, J-173, J-178, J-192, J-193	Snoots	I-58, I-59	Bracket	J-112
True wyes	J-142, J-175	Clapper type	I-59	Caps	J-112
Tube hangers	J-189, J-190	Spring check type	I-58	Rigid	J-107, J-109
Tube OD fittings	J-170 to J-179	Solenoids	I-86	Swivels	J-108, J-110
U bends	J-142, J-175	Solutions on site vans	N-2	Storz fittings	J-113, J-116, J-128, J-129
Valves		Spanner wrenches	E-11, J-153	Strainers	E-16, E-17
3A sample	I-73	Special city threads	J-89	Barrel	J-128
Weld fittings J-133, J-134, J-143, J-150, J-156, J-157, J-161, J-162, J-165, J-166, J-167, J-170 to J-181, J-191 to J-196		Speed control mufflers	G-164	Basket	J-128
Wrenches	J-153 to J-155	Spill kits	M-8	Disk	D-51
Sanitary crimp fittings		Spiral		Floating	J-129
Ferrule, 304 stainless	C-37	Hose and cable protection	L-39	Low level	J-127
Sanitary (IX) fittings		Hose clamps	F-20	Polypropylene	J-51
Bevel seat	C-34	Spool adapters and couplers		T line	J-51
Clamp end	C-33	Cam and groove	D-60	Witches hat	D-51
Ferrule, flow chief	C-33	Spray balls	J-182	with spring loaded check valves	I-30
Male NPT	C-34	Spray hose		Y Line	J-51
Tube weld end	C-33	Couplings	E-14, E-43	Straps	
Scovill type fittings	C-27	Spray nozzles	K-26, K-27	King Cable™	G-47
Screw pitch gauge	M-9	Spring guard	L-42	Straub pipe couplings	J-34, J-35
Security chains	D-51	Spring return handle ball valves	I-3, I-11	Stretch straps	M-11
Self-storing air hose	L-34, L-35	Sprinkler system gauge	M-7	Suction hose couplings	E-8, E-9
Series 1 FRL's	G-54, G-90 to G-111	Squeeze Lok™ hose assembly tool	E-35	Super King™ shank couplings	E-11
Service station equipment	A-38 to A-52	Stainless steel		Surelock™ quick acting couplings	G-8
Set screw buckles	F-9	Ball cone check valves	I-28	Swaged fittings	C-4, C-19 to C-23
Shackles	G-48	Ball valves	I-9-I-11	Swage nipples	J-27
		Bolted fittings	J-26	Swivels	J-185
		Boss™		37° female	H-61
		Clamps	C-10, C-11	Air King™	G-5
		Ground joint .	C-2 to C-4, C-12, C-41	Air tool	G-45
		Male stem	C-8, C-9	Angled	G-45
		Combination nipples	E-2 to E-6	Angled industrial plugs	G-23
		Dry disconnect	A-7	Ball, with Air Chief plugs	G-23
		Dry quick disconnect	A-2, A-3, A-8	Ball, with hose barb	G-162
				Bent stem	G-45

	Page #		Page #		Page #
<i>Swivels (cont.)</i>		<i>Tees (cont.)</i>		<i>Unions (cont.)</i>	
Connectors for spray gun	K-25	Sharkbite®	J-72	Compression	J-60, J-62
Diesel fuel	A-17	Side outlet	J-17	Flare	J-66, J-67
Dubl-grip reattachables	C-32	Street service	J-17	Flareless bite fittings	J-69, J-70
Hose	K-5	Tuff-Lite	E-54	Hammer	C-15, J-29 to J-31
In-line	G-162	Test plugs and caps	M-6	Instrumentation	J-56, J-57
Joints	A-43 to A-49	Test pumps	M-5	LIQUIfit™	J-74
Loading arm	A-47	Thermometers		Push-in ... G-131, G-134, G-136, G-144, G-145, G-147, G-150, G-154, G-160	
Multi-plane hose	K-6	Bi-metal	G-129, G-130	Threaded	J-5
Single plane hose	K-6	Magnetic	G-130	TrueSeal™	J-78
		Thermowells, stainless threaded	G-130	Uni-range couplings	C-22
T		Thor style fittings	G-14 to G-16	Universal couplings	G-2 to G-9
Tag, hose	M-10	Thread		Unpolished fittings	
Tank car		Tape, PTFE	M-2	Flange	
Fittings, railroad	A-31, A-33, A-48 to A-51	Tape, stainless steel	M-2	Neck	J-181
Gaskets	A-51	Threaded			
Wrenches	A-51	Caps	J-19, J-24		
Tank truck		Elbows	J-12, J-23		
Adapter x round flange	A-31	Sch 80 polypropylene	J-21 to J-24		
API		Tees	J-16, J-17		
Coupler	A-24	Unions	J-5		
Valve	A-24	Reducing	J-5		
Coupler x round flange	A-31	Tight fill couplers and adapters	A-36	V	
Drop elbows	A-36 to A-38	Tire		Vacuum gauges	G-124
Elbows	A-36 to A-38	Inflator chuck	G-60	Valve	
Flanged tees	A-30	Inflator gauges	G-60	Actuated	
Gaskets	A-32	Pressure gauges	G-60	Accessories	I-86
Nozzles	K-2 to K-10	T line strainers	J-51	Valves	J-47
Pump adapters	J-7	Tools		3A sample	I-73
Swivels	A-44, A-47, H-77	Band clamp		3-way	I-14
Split flange	A-47	Jack type	F-9, F-10	3-way diverting	I-8
Tank truck equipment		Screw type	F-9	250 lb. steam	I-4
TTMA flange extensions	A-31	Brass ferrule crimper	F-25, F-26	500# angle	I-32
Tape	L-41, M-2, M-9, M-10	Dies	F-24, F-25	Angle	I-34, I-44, I-48
Fire	L-41	Hose cutters	L-36	Factory set pressure reducing ...	I-44
PTFE tape	M-2	Mallet	M-9	Angle, cast	I-31, I-33
Safety	M-10	Squeeze Lok™	E-35	API	A-24
T-Bolt clamps	F-15 to F-17	Torque wrenches	M-15, M-16	Automatic drain vent	I-50
Tees		True ID		Ball	I-2 to I-11, I-14, to I-16, I-42, I-62, I-63, I-74 to I-83
Air brake	G-140	Fittings	H-78	2-Way	I-42
Bull head	J-17	TrueSeal™	J-77, J-78	150# flanged	I-15
Compression	J-62, J-63	Tube hangers	J-189, J-190	Actuated	I-74 to I-83
Female reducing	J-17	Tubing		Electrically actuated	I-76
Female threaded	J-16	Braided	L-31	'T / L' port	I-77, I-78
Flare	J-67	Cutters	L-36	Electrically actuated 2-piece	I-74
Flareless bite fittings	J-70	D.O.T., air brake	L-31	Electrically actuated 3-piece	I-75
Grooved	J-46	Fluoropolymer FEP 140	L-33	Electrically actuated 3-way	I-77, I-78
Hydraulic	H-63	Nylon	L-32, L-33	Encapsulated	I-62
Flat face	H-56	Polyethylene	L-32	2-way 3-piece	I-62, I-63
NPTF	H-70	Polyurethane	L-32, L-33	Mann Tek full flow	I-12, I-13
ORB fittings	H-57 to H-59	PVC clear	L-30	Non-encapsulated	I-63
Instrumentation	J-57	Valves	G-156 to G-158	Pneumatically actuated	I-81
LIQUIfit™	J-74 to J-76	Tuff-Lite fittings	E-51 to E-55	'T / L' port	I-82, I-83
Mechanical	J-44	Adapters	E-55	Pneumatically actuated 2-piece	I-79
Push-in ... G-132, G-135, G-136, G-145, G-148, G-150, G-154, G-160, G-161		Tuff-Lite™ fittings	J-21 - J-24	Pneumatically actuated 3-piece	I-80
Sanitary	J-140, J-173, J-178, J-192, J-193	Turned back nipples	J-37	Pneumatically actuated 3-way ...	I-82, I-83
Sched. 80 polypropylene	J-23			Ball cone check	I-28
		U		Ball, global	I-6
		Unions		Ball, mini	I-7
		Air brake	G-138, G-139	Ball, with nozzle	I-16
				Ball, with NPT tap for drain	I-4
				Butterfly I-18, I-19, I-52, I-64, I-65 to I-67, I-84, I-85	

	Page #		Page #		Page #
Valves (cont.)		Valves (cont.)		Washdown (cont.)	
Actuated	I-84, I-85	High pressure hydraulic ball	I-14	Station	K-31
Clamp	I-66	Horizontal swing check	I-30	Hot and cold water mixing	K-31
Repair kits	I-66	Industrial wafer ball	I-12	Rack for mixing	K-31
Clamp end	I-64, I-65	In-line check	G-158	Water-steam	K-31
With infinite position handle	I-64	In-line flow control	G-156, G-157	Swivel connectors	K-25
With pull handle	I-64	Lead free brass ball	I-6	Washers	
With trigger handle	I-65	Locking handle	I-3	Air King™	G-6
Lug	I-85	Needle		Cam and groove	D-48 to D-50
Pneumatically actuated	I-85	Hydraulic		Garden hose	E-47
Male x female swivel	I-52	Bleed	I-23	Holedall™ petroleum	C-31
pneumatic canister style actuator	I-67	Block and bleed	I-23	Suction and shank fittings	E-15
Repair kits	I-65	Mini	I-22	Water regulators	G-62, G-98
Storz x female swivel	I-52	Multiport	I-22	Watts FRL's	G-50, G-112 to G-118
vertical double acting pneumatic	I-67	Piston intake relief	I-51	Wave seal clamps	F-4
Vertical spring return actuation	I-67	Pneumatic		WD-40	M-8
Wafer	I-84	Needle	I-25	Welding	
Pneumatically actuated	I-84	Polypropylene	I-15, I-16	Gauges	G-127
Wet-R-Dri™	I-18	Pressure reducing	I-46, I-47	Nipples	J-32
Button	I-24	Factory set	I-46	One-piece 150# flange to adapters	C-16
Check	G-158, I-28 to I-30, I-49, I-68 to I-70, I-74, I-74	Field adjustable	I-47	Sanitary	J-133, J-134, J-143, J-150, J-156, J-157, J-161, J-162, J-165 to J-196
800 PSI stainless steel	I-29	Push pull drain	I-50	Threaded fittings	J-32
Air blow	I-70	Quick exhaust	G-156	Wharf hydrants	I-40
Repair kit	I-70	Regulating	I-46	Whipsock	G-48
Groove x groove	I-49	Safety check	I-26	Wilkerson FRL's	G-61 - G-89
Spring	I-68	Safety pop-off	I-27	Witches hat strainers	D-51
Repair kits	I-68	Safety vented	I-4	Worm gear clamp rack	F-14
Y ball	I-69	Solder end	I-6	Worm gear clamps	F-2, F-3, F-14
Repair kits	I-69	Spring loaded	I-29, I-30	Marine grade	F-3
Chicago pattern	I-49	Sprinkler hose	I-50	Wrenches	
Compact polypropylene	I-16	Swing check, horizontal	I-30	Hex	J-155
Composite mini ball	G-156	Tank filler	I-24	LP gas hose	J-53
Compressor Y	G-51	Tank vent	I-71, I-72	Pin lug	A-51
Deadman handle	I-3, I-11	Air & vacuum relief	I-71, I-72	Spanner	E-11, J-113 to J-116
Domestic gate	I-17	TrueSeal™	J-78	Storz	J-113, J-116
Domestic swing check	I-30	Wye	I-40, I-41	Wrench grips	J-33
Drip	I-43	Forestry grade ¼ turn ball type	I-40	Wyes	I-42
Angled ball	I-43	Wyes		Plain	I-42
Straight ball	I-43	¼ turn ball type	I-41	With pin lugs	I-42
Dual Y ball	I-7	¼ turn plug type	I-41		
Flanged	I-15	Full flow ¼ turn ball type	I-41		
Flow control	G-156, G-157, I-20, I-21	Leader line ¼ turn ball type	I-41		
Metering	I-20	Vapor recovery couplers	A-28, A-29		
Foot	E-18	Velcro straps	D-52		
Gate	I-3, I-35 to I-39, I-88	Vent			
Hydrant	I-38	Breather	G-163		
with speed handle	I-38	Stationary	A-41		
Large diameter (LDH)	I-39	Vent-Lock™	D-9		
Non-rising stem wedge disc	I-35, I-36				
Rising stem wedge	I-36				
Single hydrant	I-37, I-38				
with handwheel	I-38				
with hand wheel	I-37				
with speed handle	I-37				
Globe	I-18, I-43, I-45				
Factory set pressure reducing	I-45				
Straight	I-43				
Grooved end iron butterfly	J-47				
High pressure	I-14				
		W			
		Wafer ball valves	I-12		
		Wall hydrant	I-61		
		Exposed two way	I-61		
		Wall plate	I-59		
		For concealed three way bodies	I-59		
		For double clapper Siamese assemblies	I-59		
		Washdown			
		Hose	L-8		
		Spray valves	K-28		

Y

Y, compressor	G-51
Y, connectors	G-136, G-161
Y, dual valve	I-7
Y line strainers	J-51
Y, unions	G-136

Part Number Index

Page #	Page #	Page #	Page #
•AGBF• H-26	•HBF•-S H-2	•ST-BMK H-35	•WSF•-SS H-44
•AGBF•-PV H-26	•HBF•-SS H-2	•STDP-A H-35	•WSF•-SS-BOP H-46
•AGDP H-27	•H-BRKIT H-8	•STF• H-33	•WSOF• H-44
•AGF• H-26	•H-BSKIT H-7	•STF•• H-33	•WS-RKIT H-45
•AGF•-PS H-26	•HDP-A H-6	•STF••-SS H-33	•WS-SKIT H-45
•AGF•-PV H-26	•HDP-H•DC H-6	•STF•-SS H-33	
•AGF•-PV-PS H-26	•HF• H-2	•STOF• H-33	••CVVBF•• H-53
•AGOF• H-26	•HF•-B H-2	•STOF•• H-33	••CVVDP H-54
•AGOF•-PS H-26	•HF•-BOP H-36	•ST-SKIT H-35	••CVVF•• H-53
•AGOF•-PV H-26	•HF•-S H-2	•TDP H-51	••EF••-B H-37
•AGOF•-PV-PS H-26	•HF•-SS H-2	•TM• H-50	••EF••-S H-37
•CM4B•-B H-30	•HF•-SS-BOP H-36	•TRBF• H-52	••EM••-B H-37
•CM4B•-B-E H-30	•HOF• H-2	•TRF• H-52	••E-SKIT H-39
•CM4S•-B H-30	•H-RKIT H-8	•TR-SKIT H-52	••HBF•• H-4
•CM4S•-B-E H-30	•HSBF•-B H-14	•VBF•-B-E H-18	••HBF••-B H-4
•CM9B•-B H-31	•HSBF•-S H-14	•VBF•-E H-18	••HBF••-S H-4
•CM9B•-B-E H-31	•HSF•-B H-14	•VBF•-SS-E H-18	••HBF••-SS H-4
•CM9S•-B H-31	•HSF•-S H-14	•V-BRKIT H-23	••H-BRKIT H-8
•CM9S•-B-E H-31	•H-SKIT H-7	•VDP-A H-21	••HDP-A H-6
•CMB•-B H-30	•H-SRKIT H-8	•VDP-V•DC H-21	••HF•• H-4
•CMB•-B-E H-29	•H-SSRKIT H-8	•VEPBF• H-47	••HF••-B H-4
•CMF•-B H-29	•HTBF• H-9	•VEPDP-A H-48	••HF••-S H-4
•CMF•-B-E H-29	•HTBF•• H-9	•VEPF• H-47	••HF••-SS H-4
•CMPC-B H-31	•HTBF••-SS H-9	•VEPF•-BOP H-49	••HOF•• H-4
•CMS•-B H-29	•HTBF•-SS H-9	•VEPOF• H-47	••H-RKIT H-8
•CMS•-B-E H-29	•HTDP H-11	•VF•-B-E H-18	••H-SKIT H-7
•CM-SKIT H-31	•HTF• H-9	•VF•-E H-18	••H-SRKIT H-8
•CVVBF• H-53	•HTF•• H-9	•VF•-SS-E H-18	••H-SSRKIT H-8
•CVVDP H-54	•HTF••-SS H-9	•VJM• H-16	••HTBF•• H-9
•CVVF• H-53	•HTF•-SS H-9	•VM• H-16	••HTF•• H-9
•CVVFM•••• H-53	•HTJB• H-11	•VM•-B H-16	••HTOF•• H-9
•CVVOF• H-53	•HTM• H-9	•VM•-B-E H-19	••KBF•• H-24
•EAF• H-40	•HTOF• H-9	•VM•-E H-19	••KF• H-24
•EBF•-B H-37	•HTOF•• H-9	•VM•-SS H-16	••K-SKIT H-25
•EF•-B H-37	•HTOM• H-9	•VM•-SS-E H-19	••STBF•• H-33
•EF•-S H-37	•HTRB• H-11	•V-RKIT H-23	••STF•• H-33
•EM•-B H-37	•KBF• H-24	•V-SKIT H-22	••STOF•• H-33
•EM•-S H-37	•KBF•-SS H-24	•V-SSRKIT H-23	••VBF••-B-E H-18
•ES•-B H-37	•KDP-K•DC ... H-21, H-25	•WBF•-B H-41	••VBF••-E H-18
•E-SKIT H-39	•KF• H-24	•WBF•-B-HN H-41	••VBF••-SS-E H-18
•HBF• H-2	•KF•-SS H-24	•WDP H-42	••VDP-A H-21
•HBF•-B H-2	•KOF• H-24	•WF•-B H-41	••VEPBF•• H-47
	•K-SKIT H-25	•WF•-B-HN H-41	••VEPDP-A H-48
	•PDF• H-32	•W-RKIT-V2 H-43	••VEPF•• H-47
	•PDM• H-32	•WSBF• H-44	••VEPF••-BOP H-49
	•STBF• H-33	•WSBF•-SS H-44	••VEPOF•• H-47
	•STBF•• H-33	•WSDP-A H-45	••VF••-B-E H-18
	•STBF••-SS H-33	•WSF• H-44	••VF••-E H-18
	•STBF•-SS H-33	•WSF•-BOP H-46	••VF••-SS-E H-18

In the following index, a (*) is used to represent a variable. Therefore, to find AD075EZ or AD400EZ, look for: AD***EZ

Index



Part Number Index

Index

	Page #		Page #		Page #		Page #
••VJM••	H-16	100-AA-••	D-34	10-DBHU-10	J-56	125-E-••	D-23
••VM••	H-16	100-A-HA	D-30	10-DCAP	J-58	125-F-••	D-25
••VM••-B	H-16	100-AL-••	D-40	10-DELU-10	J-57	125-G-••	D-48, D-49
••VM••-E	H-19	100AWBPSTSS	D-42	10-DFC-•	J-55	125-G-•••	D-48, D-50
••VM••-SS	H-16	100AWSPSS	D-42	10-DFPLUG	J-58	125GTFACC	D-50
••VM••-SS-E	H-19	100-B-••	D-13	10-DMC-•	J-55	125GTFVI	D-49
••V-SKIT	H-22	100-C-••	C-39, D-15	10-DTTT-10	J-57	125GTHK	D-48
••WBF••-B	H-41	100-D-••	D-20	10-DU	J-56	126-••••	E-23
••WBF••-B-HN	H-41	100D-90••	D-38	11-009-•••	G-99	126-••••C	E-23
••WDP	H-42	100DA-90••	D-37	1125A	K-2, K-3	128P•LJ15	C-21
••WF••-B	H-41	100-DC-••	D-26	112D	K-3	128P•SO15	C-21
••WF••-B-HN	H-41	100DHAN-AL	A-47	112DNS	K-3	129-••••C	E-24
••W-RKIT-V2	H-43	100-DL-••	D-40	112DSK	K-3	129-••••CLF	E-24
••WSBF••	H-44	100-DP-••	D-29	114/2D-TK	K-4	129-••••SS	E-24
••WSBF••-SS	H-44	100DWBPSTSS	D-41	1143A	K-2, K-3	12-DBHU-12	J-56
••WSDP-A	H-45	100DWSP••	D-41	114D	K-3	12-DCAP	J-58
••WSF••	H-44	100-E-••	C-40, D-23	114DAL-AV-16	K-4	12-DELU-12	J-57
••WSF••-BOP	H-46	100-E-HA	D-30	114DAL-AV-19	K-3	12-DFC-••	J-55
••WSF••-SS	H-44	100-F-••	D-25	114DAL-AV-25	K-4	12-DFE-12	J-56
••WSF••-SS-BOP	H-46	100-F-HA	D-30	114D-AV	K-4	12-DFE-8	J-56
••WSOF••	H-44	100-G-••	D-48, D-49	114D-AV-06ASM	K-4	12-DFPLUG	J-58
••WS-RKIT	H-45	100-G-•••	D-48, D-50	114DAVR	K-4	12-DMC-•	J-55
••WS-SKIT	H-45	100GTFACC	D-50	114DAV-SK	K-4	12-DMC-••	J-55
		100GTFVI	D-49	114DNS	K-3	12-DME-12	J-56
0•••	F-12, F-13, L-32	100GTHK	D-48	114DSK	K-3	12-DME-8	J-56
0••••	L-32	100-HP-SP	D-45	1204-••••	H-60	12-DRATT-16	J-56
0•••R	F-12	100PRSCSS	D-51	1208••	L-32	12-DRATT-8	J-56
001-••••	M-12	100TP	M-6	1217AR-•	G-49	12-DTMT-••	J-57
0304C-•	H-64	1010-6	L-41	1217AR-4••	G-49	12-DTTM-12	J-57
0304C-••	H-64	1012CIPUSH	M-4	1217AR-4AK-KSW	G-48	12-DTTM-8	J-57
0306-•	H-65	1015-DA-••	D-32	1217AR-4AKWF	G-50	12-DTTT-•	J-57
0306-••	H-65	102-••••BSPT	E-22	1217FRAME	G-49	12-DTTT-12	J-57
0318-•	H-64	102-••••C	E-21	1231-••••	H-57	12-DU	J-56
0318-••	H-64	102-••••CLF	E-21	1234-••••	H-61	12P•	C-22
0319-•	H-64	10210-64	L-41	1238-••••	H-58	12SFO	H-75
0319-••	H-64	1025P••••	G-160	124-••••K	E-23	12SFXO	H-75
0610-4	L-41	103-••••	E-21	1240-••••	H-59	1310-8	L-41
0817••	L-32	103-••••C	E-21	1250-94	K-4	134-••••	E-24
0817BL100	L-32	104-••••C	E-22	1250SK	K-4	134-••••C	E-24
09-31•-00001	J-125	104-••••CLF	E-22	1251-••H	H-71	139-••••	E-26
		104-••••SS	E-22	1254-••H	H-64	139-••••C	E-26
1•	F-19	105-••••	E-27	1255-••H	H-59	13BN	J-132
1••	F-12	105-••••C	E-27	125-A-••	D-12	13BNH	J-132
1•••	F-12, F-13, F-18, L-32	1091P••••	L-33	125-AA-••	D-34	13CB-••••	J-132
1••••	F-3, L-32	1091U••••	L-33	125-B-••	D-13	13H-G•••	J-155
1•••R	F-12	1091U••R00	L-33	125-C-••	D-15	13H-G•••RJT	J-153
1••R	F-12	1092T••••	L-33	125C-90••	D-38	13IB	J-132
1••R	F-12	1094P••••	L-33	125-D-••	D-20	13IB6	J-132
10-076-004	G-102	1094U••••	L-33	125D-90••	D-38	13ILB•••	J-160
100-A-••	D-12	1094U••R00	L-33	125-DP-••	D-29	13ILB••••••	J-160



Part Number Index

Page #	Page #	Page #	Page #
13ILH*** J-160	1405-.. H-68	14WMP-R** J-133	150F-.. J-66
13ILH***-... J-160	1405-... H-68	14WMP-R*** J-133	150F-90AL D-39
13LW J-132	1405-... H-68	14WMP-R**** J-133	150-F-ALH D-25
13MHHM*** J-130	14-19-G*** J-157	14WMV-R*** J-165	150-F-HA D-30
13MHHM**.. J-130	142-**** E-26	14WMX-R*** J-165	150-G-** D-48, D-49
13MHHM***... J-130	1420***C E-26	14WQ-G*** J-162	150-G-*** D-48, D-50
13MHHM***...SN J-130	143-**** E-26	15*0904C M-14	150GPCTF A-34
13MHHM**..SN J-130	1430***K E-26	1500SK K-5	150GTF** D-49
13MHHM***SN J-130	1430407KLF E-26	1501-.. H-69	150GTFACC D-50
13MHHM-3P*** J-131	144-**** E-27	1501-... H-69	150GTHK D-48
13MHHM-3P**** J-131	144***K E-27	1501-... H-69	150TP M-6
13MHHM-3P***** J-131	144F- J-67	1501-... H-69	1510-B-** D-35
13MHHM-DP*** J-130	145-**** E-27	1502-.. H-69	1510-C-** D-35
13MHHM-DP**** J-130	145***K E-27	1502-... H-69	1510-D-** D-36
13MHHM-DP***** J-130	149F-.. J-66	1503-.. H-69	1510DAAL D-32
13MHHM-Q** J-130	149F-... J-66	1503-... H-69	1510-DA-SS D-32
13MHHM-Q*** J-130	149F-... J-66	15030FXF**00000 A-44	1510-E-** D-36
13MHHM-Q***** J-130	14A-G*** J-156	150-A-** D-12	1520-AA-** D-34
13MHHV*** J-165	14A-R***DIN J-151	150A-90** D-37	1520-DA-** D-32
13MHLA*** J-131	14A-R***RJT J-153	150-AA-** D-34	1520-F-** D-36
13MHLA100-150 J-131	14A-R***SMS J-152	150-A-ALH D-12	1540***K M-14
13MHP** J-131	14MPHR-G*** J-136	150-A-HA D-30	156..... C-11
13MHPV*** J-165	14MPHR-G**** J-136	150-AL-** D-40	156-**** M-14
13MO*** J-131	14MPHR-G***** J-136	150AWBPST** D-42	1565U K-5
13MO**** J-131	14MPHRL** J-136	150AWSP** D-42	158-**** M-14
13MO100-150 J-131	14MPHR-R** J-136	150-B-** D-13	159F-.. J-67
13NHN-G** J-190	14MPHR-R*** J-136	150B-90** D-38	15A-G*** J-157
13NHN-G***... J-190	14MPHR-R**** J-136	150-B-ALH D-13	15A-R***DIN J-151
13PS-.. J-189	14MPHR-R***** J-136	150-C-** C-39, D-15	15A-R***RJT J-153
13PS-... J-189	14MPHR-R***** J-136	150C-90** D-38	15A-R***SMS J-152
13PV-... J-168	14MPHT-R** J-135	150-C-ALH D-15	15B15-**RBF L-17
13QLH*** J-160	14MPHT-R*** J-135	150CNOSSS D-16	15B15-100RBF L-17
13QLH***-... J-160	14MPW-R** J-134	150-D-** D-20	15R-G*** J-157
13RBN-G***RJT J-153	14MPW-R*** J-134	150D-90** D-38	15WI-G*** J-161
13R-G***DIN J-151	14PRF-G*** J-156	150DA-90** D-37	15WI-R*** J-161
13R-G***SMS J-152	14QMP-G*** J-143	150-D-ALH D-20	15WLI-G*** J-161
13RP J-132	14R-G*** J-156	150-DC-** D-26	15WLI-R*** J-161
13RP6 J-132	14RMP-G*** J-134	150-DC-ALH D-26	16-... H-2, H-6
13SLN J-132	14RMP-R*** J-134	150DC-L** D-27	16-...A H-6
13SN J-132	14VB-R*** J-179	150-DD-** D-34	1610-10 L-41
13WGC*** J-132	14WHRL-R*** J-174	150-DL-** D-40	163**00C J-20
13WGC100-150 J-132	14WI-G*** J-161	150-DP-** D-29	1630*00CLF J-20
13WN* J-132	14WI-R*** J-161	150-DP-ALH D-29	164C-** J-62
13WNX J-132	14WLI-G*** J-161	150DWBPST** D-41	164C-...-... J-62
13WNXM J-132	14WLI-R*** J-161	150DWSP** D-41	165-**** J-9
14003-.. H-23	14WLMP-G*** J-133	150-E-** C-40, D-23	165***C J-9
1404-.. H-68	14WLMP-R*** J-133	150-E-ALH D-23	165***CLF J-9
1404-... H-68	14WMP-G** J-133	150-E-HA D-30	165C-.. J-62
1404-... H-68	14WMP-G*** J-133	150ENOSSS D-24	166-**** J-8
1404-... H-68	14WMP-G**** J-133	150-F-** D-25	166***C J-8

Index



Part Number Index

Index

Page #	Page #	Page #	Page #
166••••CLFJ-8	176C-0402J-63	2..... F-19	200F-90SSD-39
166FSV-••J-66	177-••••E-25	2• F-19	200-F-ALHD-25
169-••••J-13	177••••CE-25	2•• F-12	200-F-HAD-30
1690•••CJ-13	177••••SSE-25	2••• F-12	200-G-••D-48, D-49
169C-••••J-61	177-••••SSE-25	2••••E-60, F-3	200-G-•••D-48, D-50
16A-G•••J-157	177C-0402J-62	2•••••G-107 to G-109	200GPC••A-34
16AI-14I•••J-162	178••••CE-20, E-40	2•••R F-12	200GTF••D-49
16AI-14I•••RJ-162	178••••SSE-20	2••R F-12	200GTFAccD-50
16AI-15I•••J-162	1780•0•CLFE-20	200••••CF-23	200GTHKD-48
16AI-15I•••RJ-162	179-••••E-25	2000LA-41	200-HRP-••D-45
16AMP-G•••J-135	179••••CE-25	200-A-••D-12	200-HSCRp-SID-45
16AMP-G••••J-135	179••••SSE-25	200A-90••D-37	200-LH-••D-45
16AMP-G•••••J-135	179-••••SSE-25	200-AA-••D-34	200-PC-••A-34
16AMP-R••J-135	1790••CLFE-25	200-A-ALHD-12	200PRSC••D-51
16AMP-R•••J-135	1790604BARBE-25	200-A-HAD-30	200-PV-9A-41
16AMP-R••••J-135	179C-••••J-61	200-AL-••D-40	200-TCA-••A-50
16AMP-R•••••J-135	18-•••H-26, H-27	200-AL-SSANSID-40	200TPM-6
16AMP-R•••DINJ-151	18-•••••G-109, G-111	200AWBPST••D-42	200YDAAALD-44
16AMP-R•••SMSJ-152	18•57G-118	200AWSP••D-42	2010-DA-••D-32
16AMV-G••J-166	180••••FE-38	200-B-••D-13	2015-A-••D-35
16AMV-R••J-166	180••••FSSE-38	200B-90••D-38	2015-B-••D-35
16AQ-G••J-162	182••••SE-38	200-B-ALHD-13	2015-B-ALNSTD-63
16-DBHU-16J-56	182••••SSE-38	200-C-••C-39, D-15	2015-C-••D-35
16-DCAPJ-58	183••••KE-36	200C-90••D-38	2015-D-••D-36
16-DELU-16J-57	183••••KSSE-36	200-C-ALHD-15	2015-DA-••D-32
16-DFC-••J-55	184••••AE-37	200CNOSSSD-16	2015-E-••D-36
16-DFE-16J-56	18-458-00017I-45	200-D-••D-20	2015-F-••D-36
16-DFPLUGJ-58	185-••••E-37	200D-90••D-38	2025-DA-••D-32
16-DMC-••J-55	185••••KE-37	200DA-45••D-37	2025-D-ALNSTD-63
16-DME-••J-56	187.....C-11	200DA-90••D-37	2025-F-ALNSTD-63
16-DTTM-••J-57	187-••••E-37	200-D-ALHD-20	2030-A-••D-35
16-DTTT-••J-57	187••••KE-37	200DBALK-24	2030-AA-••D-34
16-DUJ-56	188-••H-76	200-DC-••D-26	2030-B-••D-35
16SFOH-75	189.....J-114, L-24	200-DC-ALHD-26	2030-DA-••D-32
16SFXOH-75	189DHJ-114	200DC-L••D-27	2030-DD-••D-34
16STDP-AH-35	19-•••H-27	200-DD-••D-34	2030-F-••D-36
16STF16-SSH-33	1910-12L-41	200DD-45••D-37	2040-AA-••D-34
16ST-SKITH-35	1BRBF•-B-7G-41	200DD-90••D-37	2040-DA-••D-32
17-•••H-3, H-6	1BRF•-B-7G-41	200-DL-••D-40	206.....C-11
17-•••A.....H-6	1BRGM•-B-7G-41	200-DP-••D-29	207BH•J-25
17-016-107G-106	1BRM•-B-7G-41	200-DP-ALHD-29	207BH••J-25
170C-••••J-61	1BRS•••-B-7G-42	200DWBPST••D-41	20SFOH-75
171C-••••J-63	1HDPH-6, H-21	200DWSP••D-41	20SFXOH-75
172••••CJ-11	1-HR1004L-26	200-E-••C-40, D-23	211-••••CJ-20
172C-••••J-62	1-HR1004-3L-26	200E-90••D-39	212.....C-11
174-••••J-8	1-HR1004AL-26	200-E-ALHD-23	213••00CLFJ-19
1740•••CJ-8	1WAYBV••I-12	200-E-HAD-30	2143SEALBUA-25
176-••••J-11	1WAYBV•••SWI-12	200ENOSSSD-24	219-••••J-20
1760•••CJ-11	1WAYBV•••VICI-12	200-F-••D-25	219••00CJ-20
1765AF-25		200F90ALD-39	21MP-G••J-137



Part Number Index

Page #	Page #	Page #	Page #
21MP-G..... J-137	250-F-.. D-25	287-....SS E-33	2FF2 G-28
21MP-G..... J-137	250-G-.. D-48, D-49	2870407CLF E-33	2FM-B G-29
21MP-R.. J-137	250-G-... D-48, D-50	288-.... E-33	2FM2 G-29
21MP-R... J-137	250GTF.. D-49	288....C E-33	2FS-B G-30
21MP-R.... J-137	250GTHK D-48	288....CBC E-33	2FS-S G-30
21MP-R..... J-137	2510-16 L-41	288-....SS E-33	2FS2.5-B G-30
21MP-R..... J-137	2520-DA-.. D-32	289-.... E-33	2-HR1004-3 L-26
2210-14 L-41	2530-AA-.. D-34	289....C E-33	2-HR1005 L-26
225..... C-11	2530-DA-.. D-32	289-....SAE E-33	2J-B G-33
228-.... J-18	2540-AA-.. D-34	2890....SAE E-33	2JB-B G-33
228....C J-18	25H-... J-155	290-.... E-34	2JF-B G-33
22MP-G... J-138	25H-..... J-155	290....C E-34	2JS-B G-33
22MP-G..... J-138	2601-... H-63	2909....CBC E-34	2L*2-B G-38
22MP-G..... J-138	2601-..-.. H-63	292....C E-34	2MF-B G-34
22MP-R.. J-138	2601-..-..-.. H-63	292....CBC E-34	2MF-PL G-34
22MP-R... J-138	2603- H-63	292-0... E-34	2MM-B G-35
22MP-R.... J-138	2603-.. H-63	294-.... E-34	2MM-PL G-35
22MP-R..... J-138	268B... E-22	294....C E-34	2MS-B G-35
22MP-R..... J-138	269C-.... J-61	294....CBC E-34	2MS-PL G-35
230FXF..00000 A-44	2700LN- H-64	294-....SS E-34	2MS2.5-PL G-35
233..... J-113, L-24	2700LN-.. H-64	296....C E-30	2NKS2 G-40
234-80- K-3	2701LN- H-65	296....CBC E-30	2SHD.. G-37
2404-.. H-60	2701LN-.. H-65	296....SS E-30	2SHDS- G-38
2404-... H-60	270AT E-35	2CJBF-B G-36	2U-B G-39
2404-..-.. H-60	270AT-RPLBlade E-35	2CJBM-B G-36	2WAYBV... I-13
2405-.. H-60	271-.... E-28	2CJF-B G-36	2WAYBV...SW I-13
2405-... H-60	271....C E-28	2CJF2-B G-58	2WAYBV...VIC3 I-13
2405-..-.. H-60	272....C E-28	2CJM-B G-36	2WCA...F- I-60
2405-..-.. H-60	272....SS E-28	2CM4S2.5-B H-30	2WCA...F-SP- I-60
24PFX-... C-35	272....W E-35	2CM4S2.5-B-E H-30	2WSA...F I-60
24SFO H-75	2720...CLF E-28	2CM9S2.5-B H-31	2WSA...F-.. I-60
24SFXO H-75	273-.... E-29	2CM9S2.5-B-E H-31	
250..... C-11	273....C E-29	2CMS2.5-B H-29	3..... F-19
2500HB0000 C-31	274....C E-29	2CMS2.5-B-E H-29	3.. F-12
2500L A-41	274....CBC E-29	2D-B G-28, G-29, G-31	3... E-63, E-64, F-12
2500SFV A-42	275..... C-11	2D-S G-28, G-29	3.... E-63, E-64, F-3
2501-.. H-62	278....C E-30	2DB-B G-28	3...-.. G-106, G-108, G-109
2501-... H-62	2789...CBC E-30	2DB-B G-31	
2501-..-.. H-62	280-.... E-30	2-DFC- J-55	3...R F-12
2501-..-.. H-62	280....C E-30	2-DMC- J-55	3..R F-12
2503-.. H-63	280....CBC E-30	2DS-B G-30	30-... H-50
2503-..-.. H-63	282-.... E-31	2DS-S G-30	30-...DP H-51
2503-..-.. H-63	282....C E-31	2-DTMT-2 J-57	30..RDSSAP A-35
250-A-.. D-12	282....CBC E-31	2-DTTM-2 J-57	300-.. H-75
250-B-.. D-13	284-.... E-32	2-DU J-56	300-... H-75
250-C-.. D-15	286-.... E-32	2FB-B G-31	300-... H-75
250-D-.. D-20	287-.... E-33	2FBF-B G-28	3000... G-155
250-DC-.. D-26	287....C E-33	2FBM-B G-29	3002... G-129
250-DP-.. D-29	287....CBC E-33	2FF-B G-28	300300MAE A-38
250-E-.. D-23	287....SS E-33	2FF-S G-28	3004... G-129

Index



Part Number Index

Index

Page #	Page #	Page #	Page #
3004030MAE A-38	300F-90SS D-39	3020-F-•• D-36	3126•••• G-154, G-161
3006•••• G-129	300-F-ALH D-25	3020-RD-•• A-34	3129•••• G-152
3009•••• ... G-129, G-152	300-F-HA D-30	3025-A-ALNST D-63	3140•••• ... G-154, G-155, G-161
300-A-•• D-12	300FT•• J-16	3025-B-ALNST D-63	3140••••DOT G-136
300A-90•• D-37	300FT•••• J-16	3025-C-•• D-35	31440-225AL A-25
300-AA-•• D-34	300-G-•• D-48, D-49	3025-DA-•• D-32	3148•••• G-153
300-A-ALH D-12	300-G-•••• D-48, D-50	3025-D-ALNST D-63	3148••••DOT G-136
300-A-HA D-30	300GPC• A-34	3025-E-•• D-36	31665660DOT G-135
300-AL-•• D-40	300GTF•• D-49	3025-F-ALNST D-63	3175•••• ... G-151, G-155, G-159
300-AL-SSANSI D-40	300GTFACC D-50	30-300F H-50	31825600DOT G-135
300-ALT-•• A-31	300GTHK D-48	304••••C J-13	31835600DOT G-136
300ASSSAP A-35	300GTHKBF D-49	3040••••CLF J-13	3199•••• G-161
300AWBPST•• D-42	300GTTFBL A-32	3040-A-•• D-35	3210-20 L-41
300AWSP•• D-42	300GTTFCB A-32	3040-AA-•• D-34	322-•••• J-16
300-B-•• D-13	300GTTFK A-32	3040ALTAL A-31	322••••C J-16
300B-90•• D-38	300GTTFTK A-32	3040-B-•• D-35	322••••CLF J-16
300-B-ALH D-13	300H-PADBR D-46	3040-C-•• D-35	324-•••• J-18
300BR•••• J-2	300H-PADSS D-46	3040-DA-•• D-32	324••••C J-18
300-C-•• C-39, D-15	300-HRP-•• D-45	3040-DD-•• D-34	3240606CLF J-18
300C-90•• D-38	300-HSCRIP-SI D-45	3040DLTAL A-31	326-•••• J-18
300-C-ALH D-15	300-LH-•• D-45	3040-F-•• D-36	326••••C J-18
300CNOSSS D-16	300-MAE A-38	306..... C-11	3260404CLF J-18
300-D-•• D-20	300MICAP•• J-19	306-•••• J-15	32P•LJ15 C-21
300-D-ALPH A-39	300MICAP•••• J-19	3060-DA-•• D-32	32P•SO15 C-21
300D-90•• D-38	300MIU•• J-5	31•• G-51	32PFX•••• C-35
300DA-45•• D-37	300MIU•••• J-5	31-•••• H-50	32SFO H-75
300DA-90•• D-37	300-PC-•• A-34	31-••••DC H-51	32SFXO H-75
300-D-ALH D-20	300PC-••AP A-35	3101•••• G-160	330FXF••00000 A-44
300DAT••SS D-32	300PRSC•• D-51	3102•••• ... G-129, G-154, G-161	33155614..... G-155
300DBAL K-24	300RHC•• J-4	3102••••DOT G-134	340-•••• H-75
300-DC-•• D-26	300RHC•••• J-4	3103•••• G-153	35•• G-44
300-DC-ALH D-26	300-SFC-•• A-34	3103••••DOT G-136	35-•••••• E-48
300DC-L•• D-27	300SSSG K-27	3104•••• ... G-129, G-154, G-155, G-161	35-••••-10 I-87
300-DD-•• D-34	300-TCA-•• A-50	3104••••DOT G-135	35••WF G-44
300DD-45•• D-37	300-TFA A-40	3106•••• ... G-154, G-155, G-160	35••WF2 G-44
300DD-90•• D-37	300-TFG A-38	3106••••DOT G-134	350..... C-11
300-DL-•• D-40	300TP M-6	3108•••• G-153, G-160	3533•• D-43
300-DLT-AL A-31	3010-RC-SS A-34	3108••••DOT G-135	3534•• D-43
300-DP-•• D-29	3014•••• G-151	3109•••• ... G-152, G-155, G-159	3543•• D-43
300-DP-ALH D-29	3015-DA-•• D-32	3109••••DOT G-134	3544•• D-43
300DWBPST•• D-41	3015-F-•• D-36	3113•••• G-152	3601•••• G-149
300DWSP•• D-41	302••••C J-12	3114•••• G-159	3602•••• G-150
300-E-•• C-40, D-23	3020-A-•• D-35	3114••••DOT G-133	3604•••• G-150
300E-90•• D-39	3020-B-•• D-35	3115••••DOT G-133	3606•••• G-149
300-E-ALH D-23	3020-C-•• D-35	3116•••• G-154, G-160	3615•••• G-149
300-E-HA D-30	3020-D-•• D-36	3116••••DOT G-134	3675•••• G-149
300EL90•• J-12	3020-DA-•• D-32	3116••••DOT G-134	370••••C J-10
300EL90•••• J-12	3020DAT••SS D-33		3700••••CLF J-10
300ENOSSS D-24	3020-E-•• D-36		



Part Number Index

Page #	Page #	Page #	Page #
3701212CG-49	3S•-15U-GFB•SS J-186	400-DLT-ALA-31	40364BLA-32
3710•••CJ-5	3S•-2U-GFB•SS ...J-186	400-DP-••D-29	40364TFA-32
3710•••CLFJ-5	3TF3H-50	400-DP-ALHD-29	4050-AA-••D-34
373••••CJ-7	3TM3-PVH-50	400-DVR-ALA-29	4050-DA-••D-32
373••••CLFJ-7	3TM3-SSH-50	400DWPST••D-41	4050-DD-••D-34
375.....C-11	3TM3-SS-PVH-50	400DWSP••D-41	4055-3L-41
375••••CJ-7	3U••-BG-39	400DWX5TCA-49	4060-A-••D-35
375••••CLFJ-7	4.....F-19	400-E-••C-40, D-23	4060-AA-••D-34
377••••CJ-3	4••F-12, F-18	400E-90••D-39	4060-DA-••D-32
377••••CLFJ-3	4•••F-14	400-E-ALHD-23	4060-DD-••D-34
379••••CJ-10	4•••••G-106 to G-111	400-F-••D-25	40A-45TCALA-50
38025600.....G-148	4••••••G-107 toG-110	400-F-ALHD-25	40BS-H•••J-159
3804••••G-148	4•••••R .. G-106 to G-109	400-G-••D-48, D-49	40BS-O•••J-159
3805••••G-147	4•••••RFG-106	400-G-•••D-48, D-50	40BS-S•••J-159
3806••••G-147	4•••••RLG-109	400GAGFID-44	40IE•••J-163
3810-24L-41	4••••RF-12	400-G-BUSSA-48	40IH•••J-163
3816••••G-147	40••REV90I-56	400GPCTFA-34	40IT•••J-163
3889••••G-148	400-•-ALGTA-26	400GTF••D-49	40IV•••J-164
390-•••H-75	40022ALTALA-31	400GTHKD-48	40MP-E•••J-144
390-••••H-75	40022DLTALA-31	400GTHKBFD-49	40MP-EZ•••J-149
391137.....K-2	400-A-••D-12	400GTTFBLA-32	40MPF-E•••J-147
3CJBF•-BG-36	400A-90••D-37	400GTTFCBA-32	40MPF-E••••J-147
3CJBM•-BG-36	400-AA-••D-34	400GTTFKA-32	40MPF-SFY•••J-147
3CJF•-BG-36	400-A-ALHD-12	400GTTFTKA-32	40MPF-SFY••••J-147
3CJM•-BG-36	400-AL-••D-40	400-LH-••D-45	40MPF-U•••J-146
3D••-B .G-28, G-29, G-31	400-ALT-••A-31	400-PC-••A-34	40MPF-U••••J-146
3D••-SG-28, G-29	400-AS-ALD-44	400-TCA-••A-50	40MPF-UW•••J-146
3DB••-BG-28, G-29	400AWBPST••D-42	400-TLT-ALA-30	40MPF-XW•••J-147
3DS•-BG-30	400AWSP••D-42	400TPM-6	40MPF-XW••••J-147
3DS•-SG-30	400-B-••D-13	401.....C-11	40MP-G•••J-146
3FB•G-31	400-B-ALHD-13	401-01G-128	40MP-G••••J-146
3FBF3G-28	400-C-••C-39, D-15	401-01SG-128	40MP-GR•••J-148
3FBM3G-29	400C-90••D-38	4020-DA-••D-32	40MP-GRE•••J-148
3FF•G-28	400-C-ALHD-15	4025-DA-••D-32	40MP-SFY•••J-145
3FF3-SG-28	400-CVR-ALA-28	4030-A-••D-35	40MP-SFYZ•••J-149
3FM•G-29	400-D-••D-20	4030-B-••D-35	40MPS-U•••J-148
3FS3-SG-30	400-D•-ALPHA-39	4030-C-••D-35	40MP-U•••J-144
3-HR1004-3L-26	400D-90••D-38	4030-CVR-ALA-28	40MP-U•••DINJ-151
3-HR1005L-26	400DA-45••D-37	4030-D-••D-36	40MP-U•••RJTJ-154
3J••G-33	400DA-90••D-37	4030-DA-••D-32	40MP-U•••SMSJ-152
3JB•G-33	400-D-ALHD-20	4030-DAVR-ALA-28	40MP-UW•••J-144
3JF•G-33	400-DC-••D-26	4030-DVR-ALA-29	40MP-UZ•••J-149
3JS•G-33	400-DC-ALHD-26	4030-E-••D-36	40MPV-G•••J-169
3MF3-PLG-34	400DC-L••D-27	4030-F-••D-36	40MPV-U•••J-169
3MM•-PLG-35	400-DD-••D-34	4030-MAEA-38	40MP-XC•••J-145
3MS3-PLG-35	400DD-45••D-37	4030-RD-••A-34	40MP-XW•••J-145
3NBM4G-11	400DD-90••D-37	40321TFA-32	40PFX•••C-35
3NCS4G-11	400DD-90••D-37	40322TFA-32	40QH•••J-164
3NM4G-11	400-DDVR-ALA-28	40323BLA-32	40QT•••J-164
3N-SKITG-12	400-DL-••D-40	40323TFA-32	40SFOH-75

Index



Part Number Index

Index

	Page #		Page #		Page #		Page #
41440-225AL	A-25	46F-••	J-65	4NM•	G-11	500BFP	E-50
41450-DCAL	A-25	46F-•••	J-65	4NM•-B	G-11	500-C-••	D-15
4-1460-AL	A-32	4895••••	G-158	4NM6-S	G-11	500-D-••	D-20
418	C-11	48F-••	J-65	4NS•	G-11	500DA-90••	D-37
41FL-•	J-67	48F-•••	J-65	4NS•-B	G-11	500-DC-••	D-26
41FS-•	J-67	48F-••••	J-65	4NS•-B-WF	G-13	500-DD-••	D-34
4215-••	G-110	48P•LJ15	C-21	4NS•-S	G-11	500-DP-••	D-29
42777••-000•	G-123	48P•SO15	C-21	4NS•-WF	G-13	500DWBPSTAL	D-41
42F-•	J-66	48PFX••••	C-35	4N-SKIT	G-12	500DWSP••	D-41
42MP-E••	J-144	48SFO	H-75	4P•	C-22	500-E-••	D-23
42MP-G••	J-146	4D••-B	G-28, G-29	4PF•	G-14	500-F-••	D-25
42MP-GRE••	J-148	4D••-S	G-28	4PF•-FS	G-15	500-G-••	D-48
42MP-SFY••	J-145	4DB••-B	G-28	4PF6-B	G-14	500GH4VBK	E-50
42MP-U••	J-144	4-DBHU-4	J-56	4PF6-S	G-14	500GHV	E-49
42MP-UW••	J-144	4-DCAP	J-58	4PM•-FS	G-15	500GHY	E-49
42MP-XC••	J-145	4-DELU-4	J-57	4PS•	G-15	500GTCABF	A-51
42MP-XW••	J-145	4-DFC-•	J-55	4PS•-B	G-15	500GTCABU	A-51
430FXF••00000	A-44	4-DFE-2	J-56	4PS•-FS	G-15	500GTCATF	A-51
430TFTFLAL•••••	A-47	4-DFPLUG	J-58	4PS•-WF	G-16	500GTCATV	A-51
430TFXTFAL•••••	A-47	4-DMC-•	J-55	4PS6-9	G-15	500GTCAVI	A-51
4315-••	G-110	4-DME-•	J-56	4PS6-S	G-15	500GTCAVITHK	A-51
4316-50	G-110	4-DRATT-2	J-56	4PSG	A-33	500GTFWB	D-49
4328-50	G-110	4DS•-B	G-30	4RKOBU	A-47	500QCF	E-48
43HTFTFLAL•••••	A-47	4DS•-S	G-30	4RKOVIVI	A-47	500QCFSS	E-48
43HTFXTFAL•••••	A-47	4-DTMT-4	J-57	4SHD••	G-37	500QCFV	E-48
440TFXTFAL•••••	A-47	4-DTTF-4	J-57	4SHDS•	G-38	500QCFVOR	E-48
44-251-00006	I-40	4-DTTM-4	J-57	5.....	F-19	500QCFVSG	E-48
44HTFXTFAL•••••	A-47	4-DTTT-4	J-57	5••	F-12, F-18	500QCK	E-48
450	C-11	4-DU	J-56	5••••	F-11	500QCKSS	E-48
4500-5	A-25	4-DU-2	J-56	5•••••	F-11	500QCKV	E-48
4500RK	A-25	4EA-SKIT	H-40	5••-••	G-108	500QCM	E-48
4500RK-V	A-25	4FB•	G-31	5••••••	G-106 to G-109,	500QCMSS	E-48
450-4S	L-35	4FBF4	G-28		G-111	500QCSG	E-48
450TFXTFAL•••••	A-47	4FBM4	G-29	5•••LP	L-25	500YC	E-49
4510-28	L-41	4FF•	G-28	5••R	F-12	501••••C	E-46
452•••	G-52	4FF4-S	G-28	500•••••	G-129	502••••CLF	E-46
4530	A-25	4FM•	G-29	5000-•	H-68	50212••C	E-46
4530SG	A-25	4FS•	G-30	5000-••	H-68	50212••SS	E-46
4540	A-25	4FS4-S	G-30	5000-•••	H-68	5030-DA-••	D-32
4540DC	A-26	4HF4-HV	H-5	5000-••••	H-68	50312••C	E-46
4540DC-1200	A-26	4-HR1005	L-26	5000-24	A-25	504-••••	E-46
4540F	A-25	4K-•-DP	H-25	5000-24L	A-25	5040-C-••	D-35
4540SG	A-25	4KDP	H-25	5000-25	A-25	5040-D-••	D-36
4540SG-RK•	A-25	4N4N	G-12	500-A-••	D-12	5040-DA-••	D-32
45CIPUSH	M-4	4NBF•	G-10	500-AA-••	D-34	5040-E-••	D-36
45HTFXTFAL•••••	A-47	4NBF•-B	G-10	500AN•	K-29	50412••C	E-46
46-003-00001	J-106	4NBM•	G-11	500-AN7	K-29	50412••SS	E-46
46-011-00418	J-106	4NBM•-B	G-11	500AWBPST••	D-42	5060-AA-••	D-34
46-030-00025	I-40, I-45,	4NF•	G-10	500AWSP••	D-42	5060-DA-••	D-32
	I-47	4NF•-B	G-10	500-B-••	D-13	5061212C	E-46



Part Number Index

Page #	Page #	Page #	Page #
5061212CLF E-46	5400B A-24	5911•1•W E-47	600-E-ALH D-23
507-•••• E-45	5400G A-24	5911212F E-47	600-F-•• D-25
50712••C E-45	5404-• H-67	5911212N E-47	600-F-ALH D-25
5071208SS E-45	5404-•• H-67	592••••K E-39	600-G-•• D-48, D-49
5071212CLF E-45	5404-••• H-67	5921212KLF E-39	600GTFVI D-49
50812••C E-44	5404-•••• H-67	595••••K E-42	600-HRP-•• D-45
50812••SS E-44	5404-••••• H-67	5951616K E-12	6030-DA-•• D-32
5081208CLF E-44	5406-••• H-67		6040-A-•• D-35
509-••••• E-45	5406-•••• H-67	6..... F-19	6040-D-•• D-36
509••12C E-45	5406-••••• H-67	6•• ... F-18, G-144, G-145	6040-DA-•• D-32
5091212CLF E-44	5406C-• H-71	6••• G-144, G-145	6050-DA-•• D-32
5091212SS E-45	5406C-•• H-71	6•••• J-21, J-23, J-25,	60C-•• J-63
50-A-•• D-12	5500-• H-68	J-51	60NAB• G-140
50-B-•• D-13	5500-•• H-68		60NAB•• G-140
50-C-•• D-15	5502-• H-69	6•••• G-107	60PT-•• J-64
50-D-•• D-20	5502-•• H-69	6••••• G-111	60RB-•• G-142
50-DC-•• D-26	5504-• H-69	600-•••• H-75	61-••• I-28
50-DP-•• D-29	5504-•• H-69	6000-•• A-36	61C-•• J-64
50-E-•• D-23	56-••• H-24, H-25	6000-••C A-37	61CL-•• J-64
50-F-•• D-25	5600-• H-70	6000ASAL A-38	61NAB• G-141
50-G-•• D-48, D-49	5600-•• H-70	6000-SSA A-38	61NAB•• G-141
50-G-TF-VI D-49	5601-• H-70	600-A-•• D-12	61RB-•• G-142
50-HP-SP D-45	5601-•• H-70	600-AA-•• D-34	61RBSG-•• G-141
5110-32 L-41	5602-• H-70	600-A-ALH D-12	6200..... A-36
5111A F-25	5602-•• H-70	600-AL-•• D-40	6200• A-36
5131212C E-47	5602-••• H-70	600-ALT-AL A-31	6200•• A-36
5141212C E-44	5604-• H-70	600AWBPST•• D-42	6200•• A-36
5141212CLF E-44	5604-•• H-70	600AWSP•• D-42	62C-•• J-60
5141212SS E-44	5605-• H-70	600-B-•• D-13	62C-•••• J-60
520••••• G-129	5605-•• H-70	600-B-ALH D-13	62CBH-•• J-60
5200-SFI A-32	56RBSG-•• G-141	600-C-•• C-39, D-15	62NAB• G-138
5200-SFI-3 A-32	57-••• H-24, H-25	600-C-•• D-38	62NAB•• G-138
5200-SFI-3-RK1 A-33	572-•••• E-31	600-C-ALH D-15	62NABH• G-138
5200-SFI-3V-RK1 A-33	572••••C E-31	600-D-•• D-20	62NBH• G-138
5200-SFI-RK1 A-33	574-•••• E-31	600D-90•• D-38	62NBH•• G-138
5200-SFIV-RK1 A-33	574••••C E-31	600DA-45•• D-37	62NFBH• G-138
5201-SFI A-32	575-•••• E-31	600DA-90•• D-37	62NFBH•• G-138
5201-SFI-RK1 A-33	575••••K E-31	600-D-ALH D-20	6302••••WP2 J-74
5204..... A-24	578••••C E-40	600-DC-•• D-26	6304••••WP2 J-74
5204LNG A-24	585••12C E-40	600-DC-ALH D-26	6306••••WP2 J-74
5204LSNG A-24	586••12C E-40	600DC-L•• D-27	6315••••WP2 J-73
5204LSNGP A-24	587••••K E-40	600-DD-•• D-34	6316••••WP2 J-74
5204NG A-24	588••12C E-40	600DD-45•• D-37	6322••••WP2 J-76
5205-RK4 A-25	589••••K E-40	600DD-90•• D-37	6325•••••WP2 J-73
5300..... A-24	59-••• J-51	600-DL-•• D-40	6326••••WP2 J-75
5300B A-24	59•1616C E-12	600-DLT-AL A-31	6340••••WP2 J-74
5300BC A-24	590••••C E-39	600-DP-•• D-29	6351••••WP2 J-75
5300G A-24	590••12CLF E-39	600-DC-ALH D-26	6366••••WP2 J-76
5354K21 A-24	591••••C E-39	600DD-L•• D-27	6382••••WP2 J-76
5400..... A-24	591••12CLF E-39	600-DD-•• D-34	6388••••WP2 J-76
	591••12SS E-39	600DD-45•• D-37	
		600DD-90•• D-37	
		600-DL-•• D-40	
		600-DLT-AL A-31	
		600-DP-•• D-29	
		600-DP-ALH D-29	
		600DWBPSTAL D-41	
		600DWSP•• D-41	
		600-E-•• C-40, D-23	

Index

Part Number Index

Index

	Page #		Page #		Page #		Page #
639C-04	J-63	65NAB••	G-139	6-DMC••	J-55	75-F••	D-25
63NAB•	G-141	66••X•	G-143	6-DME••	J-56	75-G••	D-48, D-49
63PT••••	J-63	66••X••	G-143	6-DRATT••	J-56	75-G•••	D-48, D-50
640••••	H-75	66•X•	G-143	6DS•-B	G-30	75GTFACC	D-50
6400••••	A-37	6600••	H-63	6-DTMT-4	J-57	75-G-TF-VI	D-49
6401••••	H-57	6600•••	H-63	6-DTTT-6	J-57	75-HP-SP	D-45
6401••••	H-57	6602••	H-63	6-DU	J-56	75TH2R•••SS	G-130
6401••••	H-57	6602•••	H-63	6-DU-4	J-56	7600HP	L-25
6403••	H-57	66C••••	J-60	7••••	F-19	7610-48	L-41
6403•••	H-57	66NAB••	G-137	7••	F-18	7660••••	G-157
6405•••	H-58	66NAB•••	G-137	7•••LP	L-25	7665••••	G-157
6405••••	H-58	66NBH86	G-138	70••X•	G-144	77•••	H-42
6405••••	H-58	67RBSG••	G-142	70•X•	G-144	77••••	H-42
6408HHP••	H-59	68••X•	G-143	700013•••	G-52	7770••••	G-157
6408HHP•••	H-59	68••X••	G-143	7065••••	G-156	7775••••	G-157
6410•••	H-57	68•X•	G-143	70NAB••	G-138	78•••	H-41, H-42
6410••••	H-57	68•X••	G-143	70NAB•••	G-138	78••••	H-41
6410-40	L-41	6803••	H-59	71••X•	G-146	7800MP	L-25
64NAB•	G-140	6803•••	H-59	71••X••	G-146	79•••	H-42
64NAB••	G-140	682C••••	J-61	71•X•	G-146	79••••	H-42
64P•LJ15	C-21	688••	H-76	71NAB•••VS	G-140	7910••••	G-156
64P•SO15	C-21	68C••••	J-59	71NAB••VS	G-140	7982••••	G-156
64PFX••••	C-35	68CIPUSH	M-4	71S••X•	G-146	7994••••	G-158
6500••••	A-36	68NAB••••VS	G-137	71S••X••	G-146	7996••••	G-158
6500••	H-61	68NAB•••VS	G-137	71S•X•	G-146	79NAB•••VS	G-139
6500•••	H-61	68NAB••VS	G-137	71S•X••	G-146	79NAB••VS	G-139
6500••••	H-61	68RB••••B	G-142	72••X•	G-145	8••••	K-28
6500A	A-36	68RBSG••••	G-142	72••X••	G-145	8••••H	K-28
6501•••	H-62	69••X•	G-144	72•X•	G-145	8••••LP	L-26
6501••••	H-62	69••X••	G-144	72NAB•••VS	G-140	800-A••	D-12
6501••••	H-62	69•X•	G-144	72NAB••VS	G-140	800-AL••	D-40
6501••••	H-62	69•X••	G-144	72S••X•	G-146	800AWSPAL	D-42
6502••	H-62	690••••	H-75	72S••X••	G-146	800-B••	D-13
6502•••	H-62	6901•••	H-58	72S•X•	G-146	800-C••	D-15
6502••••	H-62	6901••••	H-58	750••••	C-11	800-D••	D-20
6503••••WP2	J-75	6901••••	H-58	7550-A••	D-12	800-DC••	D-26
650-4S	L-35	69NAB••••VS	G-139	7550-E••	D-23	800-DL••	D-40
6505•••	H-61	69NAB•••VS	G-139	7550-F••	D-25	800-DP••	D-29
6505••••	H-61	69NAB••VS	G-139	75-A••	D-12	800DWSPAL	D-41
6505••••	H-61	69S••X••	G-145	75AWBPSTSS	D-42	800-E••	D-23
6505••••WP2	J-73	69S•X•	G-145	75AWSPSS	D-42	800-F••	D-25
6506•••	H-61	69S•X••	G-145	75-B••	D-13	800-G••	D-48
6506••••	H-61	6D••-B	G-28	75-C••	D-15	800-HNP-BR	D-45
6506••••	H-61	6-DBHU-6	J-56	75-D••	D-20	801-A••	D-12
650-6S	L-35	6-DCAP	J-58	75-DC••	D-26	801AWBPSTAL	D-42
6508••••WP2	J-75	6-DELU-6	J-57	75-DP••	D-29	801AWSPAL	D-42
6509••••WP2	J-75	6-DFC••	J-55	75DWPSTSS	D-41		
6579••••WP2	J-73	6-DFE-4	J-56	75DWPSS	D-41		
65NAB•	G-139	6-DFPLUG	J-58	75-E••	D-23		



Part Number Index

Page #	Page #	Page #	Page #
801-DP-•• D-29	900TK K-3	A325100••• L-9	ADD••• D-34
801-E-•• D-23	900W••• K-3	A325-50••• L-9	ADD•••• D-34
801-F-•• D-25	9076M G-52	A330100••• L-9	ADH45F••F J-126
8060-DA-•• D-32	90CDMHCB••••• I-57	A330-50••• L-9	ADH45M••F J-126
80B••-100HAF L-16	90CREV•••• I-56	A5•••••UC L-10	ADH90F••F J-126
80B••-100HCF L-16	90DCS••••F I-54	A5••••UC L-10	ADH90M••F J-126
80B••-50HAF L-16	90DCS••••F-•• I-54	A5•••-50RAF L-24	ADHC•••F J-126
80B••-50HCF L-16	90DCS••••NYFD I-54	A5••U••CBF L-10	ADHP•••F J-126
8320605..... K-28	90DCS4025F-• I-54	A510100••• L-10	ADPW I-87
850..... C-11	90DCS4030NYFDSP I-54	A510-50••• L-10	ADS••GR B-4
850••• C-32	90FR3C•••• J-121	A515100••• L-10	ADS400 D-44
851••• G-52	90FR3C••••F J-121	A515-25••• L-10	ADV150F I-50
855..... F-26	90IRC•••• J-120	A515-50••• L-10	AFC•••F-TGWP J-104
855231..... G-16	90IRC••••F J-120	A515-75••• L-10	AFN••• K-15
855A F-26	90IRC4025G J-120	A515OR50RAF L-11	AFN•••NST K-15
856-• F-26	90IRC4025GF J-120	A515OR50RAS L-11	AG•• J-37
856-•• F-26	90ISCS4025F I-53	A515R50RAF L-11	AG•BF• H-27
860..... F-27	90PPA••• D-64	A515Y50RAF L-11	AG•BF•-PV H-27
861-•• F-27	90PPC••• D-65	A525100••• L-10	AG•DC H-27
875-4 K-3	90PPD••• D-66	A525-25••• L-10	AG•F• H-27
875-5 K-3	90PPF••• D-67	A525-50••• L-10	AG•F•-PV H-27
8-DBHU-8 J-56	90SCS4025F I-53	A525-75••• L-10	AG•OF• H-27
8-DCAP J-58	90TCS••••F I-55	A7•• J-47	AG•OF•-PV H-27
8-DELU-8 J-57	90TCS••••F-•• I-55	A7••• J-47	AH••• D-27
8-DFC-• J-55	915• H-76	AAPN75GHT K-30	AH•••EZ D-28
8-DFE-8 J-56	94••U•••• G-22	AB• G-2	AHA••••ADP J-99
8-DFPLUG J-58	968..... C-11	AB•• G-2, G-4	AHA••BSP••T J-7
8-DMC-• J-55	96P•LJ15 C-21	AB••• D-14	AHDBF75 I-87
8-DME-8 J-56	96P•SO15 C-21	AB•••EZ D-14	AHGV250 I-38
8-DRATT-12 J-56	A• F-20	ABC•• E-41	AHGV250F I-38
8-DTMT-• J-57	A•• F-20	ABC250 J-103	AHGV250F-H I-38
8-DTTM-• J-57	A•VC-•MG J-78	ABH•••••F E-68	AHGV250F-I I-38
8-DTTT-8 J-57	A100C••A B-2	ABN100• K-16	AHW J-113
8-DU J-56	A100DA B-3	ABN150• K-16	AHWPT J-114
8SFO H-75	A100HC••A B-3	AC••• D-16	AK3526-300FL K-23
8SFXO H-75	A100OGA B-3	AC•••EZ D-18	AK4450NST K-23
8STBF8-V2 H-33	A200CA3P•• B-6	AC1 G-6	AKSP1 G-6
8STDP-A-V2 H-35	A200PC••A B-6	AC200TUBE D-43	AKSP25 G-6
8STF10-V2 H-33	A200PHC••A B-6	AC7 D-52	AL••• . K-33 to K-35, K-38
8STF8-V2 H-33	A210-120 B-5	ACB304 E-66	to K-40
8ST-SKIT-V2 H-35	A210-24 B-5	ACL• D-53	AL•••XX K-33
8WF8-HN H-41	A210B-120 B-5	ACL8 G-6	AL455F K-35
9..... F-19	A210B-24 B-5	ACPSO150 K-17	AL9 K-32
9•• F-18	A3•••••UC L-9	ACPSO150F K-17	ALTG•••F M-7
900..... K-3	A3••••UC L-9	AD••• D-21	AL-TPR•••• K-38
900• K-3	A315100••• L-9	AD•••EZ D-22	AM• G-2, G-49
900•34 K-3	A315-50••• L-9	AD400ALEZMTC A-49	AM•• G-2, G-4
9000-48S G-59	A320100••• L-9	AD90400•• D-38	AM•SWIV G-5
900SK K-3	A320-50••• L-9	ADA•••• D-33	AM•WF G-5
		ADA••••EZ D-33	AM11WF G-5

Index



Part Number Index

Index

Page #	Page #	Page #	Page #
AM11WF-1G-5	ATS7838FG-45	B18-••MGG-75	B2KS-R••UJ-176
AM7TG-5	ATS7838MG-45	B18-••MGMBG-75	B2S-G•••PJ-170
AMF••G-50	ATTFST40CSC-48	B19MPX-R•••J-167	B2S-G•••UJ-176
ANH••G-7	AV•••I-31, I-34	B19WB-G•••J-177	B2S-R•••PJ-170
ANH•••G-7	AV••••I-31	B19WV-R•••J-167	B2S-R•••UJ-176
ANSI••J-45	AV•••-II-33	B19WX-R•••J-167	B2S-R••PJ-170
ANT•••K-19	AV•••-RBRI-31, I-34	B22WB-G•••J-177	B2S-R••UJ-176
ANT•••FK-19	AV•••SI-31	B23BMP-G•••J-135	B2SXL••-R•••J-172
APN••••J-32	AV•••-WI-45	B23BMP-R•••J-135	B2WCL-G•••PJ-170
APRD•••FI-47	AV•••-WRI-34	B23BMP-R••••J-135	B2WCL-G•••UJ-176
AQ62DOT•G-131	AV250NYFD-II-33	B24PS-G••J-189	B2WCL-R•••PJ-170
AQ64DOT•G-132	AV251NYCI-34	B24PS-G•••J-189	B2WCL-R•••UJ-176
AQ68DOT•X•G-131	AV251NYFDI-34	B24PV-G•••J-168	B2WCL-R••PJ-170
AQ69DOT•X•G-131	AV2531I-34	B24RG-G••J-189	B2WCL-R••UJ-176
AQ69DOTS•X•G-131	AV5-250FI-32	B24RG-G•••J-189	B2WK-G•••PJ-171
AQ71DOTS•X•G-132	AV5-250NYFDI-32	B24RPH-G••J-190	B2WK-G•••UJ-177
AQ72DOTS•X•G-132	AVAPR•••FI-48	B24RPH-G•••J-190	B2WK-R•••PJ-171
AR20831K-39	AVAPR•••F-II-48	B24RV-G•••J-168	B2WK-R•••UJ-177
AR3000-A2K-35	AVAPRF•••I-48	B25-G••••••J-190	B2WK-R••UJ-177
AR3500K-38	AVAPRF•••-II-48	B25-G•••••••J-190	B2WUL-R•••PJ-175
AR5000-1K-39	AVF•••I-31, I-34	B25-G••••••••J-190	B2WUL-R•••UJ-180
AR503830SSPL-8	AVF•••-II-33	B28-••AGG-76	B2WUMP-R•••J-142
AR-BROOM16K-40	AVF5-250I-32	B28-••AGMBG-76	B3114MP-G••••••J-141
AREP400ASJ-122	AVN••••-200J-47	B28-••MGG-76	B3114MP-R••••••J-141
AR-REEL100L-8	AWR14G-6	B28-••MGMBG-76	B3114MP-R••••••J-141
ARSMSA•••FJ-93	AWR4G-6	B28AMP-R•••J-142	B3115F-G••••••J-158
ARTEL18AK-34	AWS6G-6	B28BMP-R•••J-142	B31TP-G••••••J-158
ARTEL-BELTK-34	AWSGK-25	B28WA-R•••PJ-175	B31W-G••••••PJ-174
ASB••G-7	AWSG-TGK-28	B28WA-R•••UJ-180	B31W-G••••••UJ-179
ASB•••G-7	AWSG-WK-25	B28W-R•••PJ-175	B31WMP-G••••••J-134
ASBDV••I-43		B28W-R•••UJ-180	B31W-R••••••PJ-174
ASC•••G-7	B•C-3, C-6, C-10	B2CM-G•••J-170	B31W-R••••••UJ-179
ASHV1015FI-50	B•• ..C-3, C-6, C-10, C-11	B2CMP-G•••J-138	B31W-R••••••PJ-174
ASP••BVG-163	B••SCC-5, G-49	B2CMP-R••J-138	B31W-R••••••UJ-179
ASP310•-40G-53	B07-•••AGG-91	B2CMP-R•••J-138	B31W-R••••••PJ-174
AST•E-2	B07-•••MGG-91	B2CM-R•••J-170	B31W-R••••••UJ-179
AST••E-2	B07-202•GCG-91	B2E-G•••J-158	B3214MP-G••••••J-141
ASTB••E-3	B08-02AGG-63	B2F-G•••J-158	B3214MP-R••••••J-141
ASTB•••E-3	B08-02AGMBG-63	B2FMP-14-G•••J-139	B32W-G••••••PJ-174
ATC40ASSAPIA-50	B11-••WJCG-113	B2FP-G•••J-170	B32W-G••••••UJ-179
ATC40ASSDDAA-50	B11-••WJCRG-113	B2KM-G•••J-171	B32W-R••••••PJ-174
ATCA40A-48	B16-••••SH-14	B2KMP-G•••J-139	B32W-R••••••UJ-179
ATCF40A-48	B16-•••SH-14	B2KMP-R••J-139	B32W-R••••••PJ-174
ATCF40-90A-48	B16-•63H-2	B2KMP-R•••J-139	B32W-R••••••UJ-179
ATCG40-90A-48	B16W-G•••J-177	B2KM-R•••J-171	B3401-•••H-72
ATCGF40A-48	B17-••••SH-14	B2KS-G•••PJ-171	B3401-••••H-72
ATCS40A-48	B17-•••SH-14	B2KS-G•••UJ-176	B3455-•••H-72
ATCT••A-49	B17-•63H-3	B2KS-R•••PJ-171	B3455-••••H-72
ATN100X7A-47	B18-••AGG-75	B2KS-R•••UJ-176	B3800-•••H-72
ATS••••HG-45	B18-••AGMBG-75	B2KS-R•••PJ-171	B3800-••••H-72



Part Number Index

Page #	Page #	Page #	Page #
B3801-•••H-72	B54BMP-R•••J-183	BAC-•••A-5	BDS••H-72
B3801-•••••H-72	B54BMPS-GL•••J-184	BAS97•E-46	BEC••J-47
B38SL-G•••J-181	B54BMP-SK•••J-183	BB•C-10	BF••E-22
B38SL-R•••J-181	B54BMPS-SK•••J-184	BB••C-3, C-10	BF•••E-22, F-23
B38W-R•••J-181	B54G-P•••J-183	BB•••D-14	BF••••F-23
B45AB-R•••I-70	B6-1C-6	BB•••EZD-14	BF••SSE-22
B45AB-R•••••I-70	B72G-•AGG-99	BB3-0•AGG-62	BF30•-•••••J-188
B45AB-RKI-70	B72G-•AG-MBG-99	BB3-0•AGMBG-62	BF302•-•••••J-188
B45BC-R•••I-70	B72G-•MGG-99	BB3-0•MGG-62	BFC•••I-20
B45BC-R•••••I-70	B72G-•MG-MBG-99	BB3-0•MGMBG-62	BFC••••I-20
B45BY-R•••I-69	B73G-•AGG-100	BBFVW•••I-19	BFL•••F-23
B45BY-RK•••I-69	B73G-•AG-MBG-100	BBFVW•••EI-19	BFM•••BF-23
B45BY-SK•••I-69	B73G-•MGG-100	BBLV••G-49, I-3	BFMW••••F-23
B45BY-SKV•••I-69	B73G-•MG-MBG-100	BBLV•••I-3	BFN•••K-11
B45BY-TB•••I-69	B74G-•AG-MBG-100	BBU•C-10	BFN•••NSTK-11, L-24
B45CC-R•••I-70	B74G-•MG-MBG-100	BBU••C-10	BFN75K-11
B45CC-R•••••I-70	B7MP-G•••J-140	BBV••I-2	BFN75GHTK-11
B45MP-R••I-68	B7MP-R••J-140	BBV•••DTWI-8	BFNE150K-11
B45MP-RK•••I-68	B7MP-R•••J-140	BBV•••DWI-7	BFNE150NSTK-11
B46MP-R•••I-68	B7MPS-R•••J-140	BBV•••DWVI-7	BFO•••M-14
B46MP-RK•••I-68	B7RMP-G•••••J-140	BBV•••FPI-2	BFP200I-49
B5101E•••CC-AI-64	B7RMP-R•••••J-140	BBV•••LVI-4	BFS••E-23
B5101E•••CC-BI-64	B7RMP-R•••••J-140	BBV•••SRI-3	BFS•••E-23
B5101E•••CC-CI-65	B7RWWW-G•••••P J-173	BBV•••STI-4	BFVL•••I-19
B5101E•••CC-FI-67	B7RWWW-G•••••U J-178	BBV•••TWI-8	BFVL•••EI-19
B5101E•••CC-GI-67	B7RWWW-R•••••P J-173	BBV•••VTI-4	BFVW•••I-19
B5101E•••CC-HI-67	B7RWWW-R•••••U J-178	BBV••DTWI-8	BFW•••F-23
B5101-RKE•••I-65	B7W-G•••PJ-173	BBV••LVI-4	BFW••••F-23
B5101-RKS•••I-65	B7W-G•••UJ-178	BBV••SRI-3	BGB•C-2, C-3
B5101-RKV•••I-65	B7W-R•••PJ-173	BBV••STI-4	BGB••C-2, C-3
B5101S•••CC-AI-64	B7W-R•••UJ-178	BBV••TWI-8	BGE••G-57
B5101S•••CC-BI-64	B7W-R••PJ-173	BBV••VTI-4	BGE6G-57
B5101S•••CC-CI-65	B7W-R••UJ-178	BBV100I-2	BGF••C-2
B5101V•••CC-AI-64	B7WWW-G•••PJ-173	BBV75FPI-2	BGH••E-40
B5101V•••CC-BI-64	B7WWW-G•••UJ-178	BC••E-39	BGHF••E-40
B5101V•••CC-CI-65	B7WWW-R•••PJ-173	BC•••D-16	BGHM••E-40
B5102E•••-AI-66	B7WWW-R•••UJ-178	BC•••EZD-18	BGV••I-17
B5102-RKE•••I-66	B9MP-G•••J-141	BC61-•••A-5	BGV•••I-17
B5102-RKS•••I-66	B9MP-R•••J-141	BC62-•••A-5	BH•••D-27
B5102-RKV•••I-66	B9WWW-G•••PJ-175	BCC-•••J-142	BH•••EZD-28
B5102S•••-AI-66	B9WWW-R•••PJ-175	BCF••E-39	BH6D-45
B5102V•••-AI-66	BA••E-44	BCM••E-39	BHSC152D-45
B5121E•••0L-BBCI-85	BA•••E-45, E-46	BCN••J-10	BHSC175D-45
B5121E•••0L-BCCI-85	BA•F•FJ-5	BCN•••J-10	BHSC34D-45
B5121E•••0W-BBCI-84	BA31-•••A-5	BCC-•••A-5	BHT••••J-17
B5121E•••0W-BCCI-84	BA32-•••A-5	BCV•••I-28	BIA250•J-123
B5121E1•00L-BCCI-85	BA61-•••A-5	BCW-•••J-176	BIB250•J-123
B5121E1•00W-BBCI-84	BA62-•••A-5	BDC-10	BIC150J-124
B5416MP-A•••J-183	BA776E-44	BD•••D-21	BID250•J-123
B5416MP-A•••••J-183	BA97•E-46	BD•••EZD-22	BIDC250J-124

Index



Part Number Index

Index

	Page #		Page #		Page #		Page #
BIDP250	J-124	BPN***	E-28	BTB-T**Z	L-38	C03-0**MMB	G-64
BIE150	J-124	BR****	J-2, L-31	BTN75	K-29	C08-02A	G-64
BIF250*	J-123	BR****B	J-3	BU*	C-10	C11-**A	G-116
BIT-KIT	K-32	BR****FS	J-3	BU**	C-10, C-11	C11-**M	G-116
BL***	K-2	BR****G	J-2	BV2*	I-24	C119-**A	G-116
BL***NS	K-2	BR****SS	J-3	BV2BV-***11-**	I-76	C119-**AMB	G-116
BLCA152CS	D-52	BR1BF*-B-E-7	G-41	BV2BV-***11-BBC	I-81	C119-**M	G-116
BL-RK*	K-2	BR1F*-B-E-7	G-41	BV2BV-***11-BCC	I-81	C119-**MMB	G-116
BL-RK**	K-2	BR1GM*-B-E-7	G-41	BV2CV-***CC-A	I-62	C16-**A	G-79
BL-RK***	K-2	BR1M*-B-E-7	G-41	BV2GG-***CC-A	I-63	C16-**AMB	G-79
BLS**	E-12	BR1S*-**B-E-7	G-42	BV2HG-***11-**	I-74	C16-**M	G-79
BLS***	E-12, E-42	BRN150	K-12	BV2HG-***11-BBC	I-79	C16-**MMB	G-79
BLS***NST	E-13	BRN150NST	K-12	BV2HG-***11-BCC	I-79	C18-**A	G-80
BLS**NST	E-13	BRN150NST-I	K-12	BV2IC-***WW-A	I-12	C18-**AMB	G-80
BLS8*8	E-12	BRN150S-I	K-12	BV2IG-***11-**	I-75	C18-**M	G-80
BLT*****	J-49	BS**	C-11	BV2IG-***11-A	I-11	C18-**MMB	G-80
BM*	E-20	BS***	E-9, E-10	BV2IG-***11-BBC	I-80	C2	F-11
BM**	E-20	BS*-***-***	J-188	BV2IG-***11-BCC	I-80	C26-**A	G-80
BM*-*	E-20	BS*-***-***-***	J-188	BV2IG-***33-A	I-11	C26-**AMB	G-80
BMA***	E-46	BS-***-***-***	J-188	BV3BV*R-***1	I-78	C26-**M	G-80
BMAS***	K-25	BS**N	E-9	BV3BV*R-***1BBC	I-83	C26-**MMB	G-80
BMS*	C-8	BS61-***	A-5	BV3BV*R-***1BCC	I-83	C28-**A	G-81
BMS**	C-8	BS62-***	A-5	BV3IG*F-***1-**	I-77	C28-**AMB	G-81
BMV**	I-3	BS8*8	E-10	BV3IG*F-***1BBC	I-82	C28-**M	G-81
BMV100	I-3	BS818	E-39	BV3IG*F-***1BCC	I-82	C28-**MMB	G-81
BN*	K-22	BSB**	G-7	BVDSO***	K-18	C31-**A	G-81
BN**	E-21, K-22	BSB-**	L-37	BVDSO***NST	K-18	C31-**AMB	G-81
BN***	E-21, I-21	BSB***	G-7	BVFS**	I-30	C31-**M	G-81
BN****	I-21	BSB-**-**	L-37	BVSO***	K-18	C31-**MMB	G-81
BN***RU**	E-36	BSB-**-***	L-37	BVSO***NST	K-18	C31-08FRAME	G-83
BN***RU**SS	E-36	BSB-**-T	L-37	BVSO150-125	K-18	C33112*	L-26
BN**BSPT	E-22	BSB-**-T-***	L-37	BVSO150NST-125	K-18	CAB***	E-8
BN**F	K-22	BSB-20Z	L-37	BVTSO150	K-18	CAB***N	E-9
BN**NYFD	K-22	BSC***	G-7	BVTSO150-200	K-18	CAL**	D-53
BN**RU**	E-36	BSCCQ*-R***	J-187	BVTSO150NST	K-18	CAMOPENER	D-8
BN**RU**SS	E-36	BSCCQ3-R***	J-187	BVTSO150NST-200	K-18	CAP***F-C	J-101
BNH**	G-7	BSCCQ4-R***	J-187	BWSG	K-25	CAP***F-C-LH	J-101
BNH***	G-7	BSCCS*-R***	J-187	BWSG-TI	K-27	CAP***S-C	J-101
BNS**	K-25	BSKTST***F	J-128	BWSG-W	K-25	CB	C-3
BNS**SS	K-25	BSM**	J-11	BZ4051	A-40	CB6-**AG	G-75
BNT***F	K-22	BSO150-H	K-22	BZ4051S	A-40	CB6-**AGMB	G-75
BOC-T**	L-38	BSO150NST	K-22	C**	J-39	CB6-**MG	G-75
BP***	J-28	BSO150S	K-22	C***	J-39	CB6-**MGMB	G-75
BP***T***	J-28	BSS61-***	A-5	C****	M-15	CBB***	E-8
BPF**	E-29	BSS62-***	A-5	C***BU	J-39	CBC**	E-41
BPF***	E-29, I-21	BST*	E-2	C**BU	J-39	CBSR***	C-36
BPFS**	E-30	BST**	E-2	C**BU	J-39	CC	C-6
BPM*	E-30	BSVD-HC***B***	I-73	C03-0*A	G-64	CC***	L-34
BPM**	E-30	BSVS-HC***B***	I-73	C03-0*AMB	G-64	CC****B	L-34
BPN**	E-28	BTB-T**	L-38	C03-0*M	G-64	CCF****	F-22



Part Number Index

Page #	Page #	Page #	Page #
CCH50 L-29	CL..... L-30	CVS.. D-52	D8•Y100RAF L-11
CD C-10	CM•F• H-28	CVV•BF• H-53	D8•Y50RAF L-11
CDMHCB..... I-57	CM•F•-B H-28	CVV•DC H-54	D815100... L-11
CF••••CS ... C-44, C-45	CM•M•-B H-28	CVV•F• H-53	D815-25... L-11
CF••••SS ... C-44, C-45	CM•M•-B-L• H-28	CVV•BF• H-53	D815-50... L-11
CF••••CS ... C-44, C-45	CM•M•-B-L•• H-28	CVV•DC H-54	D815Y100RAS L-11
CF••••SS ... C-44, C-45	CM3M2-B-L11.5 H-28	CVV•F• H-53	D815Y50RAS L-11
CF400••CSHD C-51	CMF•• G-163	CVV•FM•••• H-53	D825100... L-11
CF400••CSHD C-51	CN A-18	CVV•OF• H-53	D825-25... L-11
CFB••••S K-14	CN••• J-10	CWG-C-•,•••• L-42	D825-50... L-11
CFB•••NST K-14	CN•••B J-9	CWG-S-•,•••• L-42	DAA•••AL A-12
CFB•••S K-14	CN•••G J-10	CWH50 L-27	DAA•••ALFL A-12
CFB75GHT K-14	CN•••SS J-10	D•• G-49, I-88, I-3	DAB• K-6
CFFR150 K-16	CNB75GHT K-30	D••• G-60	DAB•• K-6
CFFR150NST K-16	CNB75GHT-GD K-30	D••••• E-68	DAC•••• K-6
CFG•••NST K-14	CN-P A-18	D••••F E-68	DAC•••AL A-11
CFG•••S K-14	CN-PLUG A-18	D•••R G-162	DAC•••ALBSP A-11
CFR•• L-21	CPV•••F I-49	D•••S G-162	DADC250 A-12
CFR47-1-••• L-21	CR F-14	D•••U G-45	DADP250 A-11
CFR47-150-••• L-21	CR-C A-18	D••SC I-88	DATL•• G-51
CFR47-C• L-21	CR-CAP A-18	D•B• G-31	DATL•••W G-51
CFS800-•CS .C-14, C-49	CR-S A-18	D•BF• G-27	DAWS•• K-6
CG••• F-9	CRWC F-14	D•BM• G-27	DB• C-7
CGN•••NST K-21	CS••• F-9	D•F• G-27	DB•• C-7
CGSN•••F K-21	CS•••••AL ... C-42, C-43	D•M• G-27	DBA••••• A-3
CGSN•••S K-21	CS•••••CS ... C-42, C-43	D•M•-B G-27	DBAF••••• A-3
CH-B-• D-52	CS•••••SS ... C-42, C-43	D150SDB K-26	DBAF••••••• A-3
CH-B-•• D-52	CS•••••AL C-42, C-43	D150S-WAND K-26	DBAV73-2030 A-4
CH-C-•• D-52	CS•••••CS C-42, C-43,	D18-04M G-82	DBC••••• A-2
CH-SS-• D-52	F-21	D18-04MMB G-82	DBC•••••-GL A-2
CH-SS-•• D-52	CS•••••SS C-42, C-43	D2•• G-31	DBCL••• A-2
CI9 M-4	CSB••• E-9	D201 G-57	DBGV•• I-17
CI9311SML M-4	CSC-T••-1 H-79	D201RT G-56	DBGV••• I-17
CI96 M-4	CSC-T••-2 H-79	D204-30 G-55	DBS••••• A-2
CI96AH M-4	CSCTF25F30T-• I-59	D204-30P G-55	DBV-BL••• J-43
CILR••• C-36	CSCTM25F30T-• I-59	D204-30SB G-55	DBV-BN••• J-43
CJ•BF•-B G-36	CSES150F J-117	D263 E-68	DBV-WB••• J-43
CJ•BM•-B G-36	CSES150T J-117	D263F E-68	DC• G-19, G-24
CJ•BM•-LG G-36	CSES2015F J-117	D28-••MMB G-82	DC•• G-19, G-25, G-26
CJ•F•-B G-36	CSM••• E-9	D2B2-B G-31	DC••• G-24
CJ•M•-B G-36	CSN75 K-29	D2C••••• A-4	DC••••• .G-19, G-20, G-25
CJ•M•-LG G-36	CSS•••••CS F-21	D2F•-B G-27	DC••••L G-19, G-25
CJ2BF•-LG G-36	CSS•••••CS F-21	D2S•-B G-28	DC••••LSE G-21
CJ2F•-LG G-36	CSSR••• C-36	D34•• G-50	DC••••SE G-21
CJ2M2-B G-58	CSSR•••CS C-36	D-4HF4-S-FNS H-5	DC•••L G-24
CJ3BF• G-36	CSSTF••F••T-• I-58	D-4HF4-S-FSB H-5	DC••S G-28, G-29
CJ3BM• G-36	CSSTM25F30T-• I-58	D-4HF4-SS-FNS H-5	DC••SE G-21
CJ3F• G-36	CT•••L F-5	D-4HF4-SS-FSB H-5	DC•SE G-21
CJ3M• G-36	CTER••• C-36	D605 G-57	DC1045S G-30
CL•••• L-30	CV••• I-29	D75AL I-88	DC2•••S G-30

Index



Part Number Index

Index

	Page #		Page #		Page #		Page #
DC9S	G-29	DDSC•••SS	A-9	DHSSC6	J-126	DN7•OBF	K-9
DCB••	G-28, G-29	DDT1	M-9	DIN-SMS-60/90SP	J-154	DN7U•BF-NC	K-9
DCB•••	G-29	DEFN075	K-10	DIN-SMS90/155SP	J-154	DN7U•BF-NPNF	K-9
DCB••••	G-28 to G-30	DF16•••	J-115	DKC1	G-18	DNOG•	K-10
DCL••	M-8	DFC••	J-58	DL••	F-18	DNOG5-NL	K-10
DCM1	M-9	DFC•••	J-58	DL•••	F-18	DP2-01•••	G-86
DCP•	G-23	DFG•	G-60	DL••••	F-4	DPW	I-87
DCP••	G-17, G-25, G-26, G-36	DFN•••	K-8	DLB12	C-12	DRC••	J-58
DCP•••	G-23, G-27, G-32	DFN100••-NC	K-7	DLS••••	F-4	DRC•••	J-58
DCP••••	G-17, G-18, G-25, G-28	DFN100••-NPNF	K-7	DM•	E-19	DRK15	M-9
DCP••••L	G-18, G-25, G-31	DFN100••F	K-7	DM••	E-19	DRP-85-059	G-85
DCP•••L	G-23	DFN100F-NC	K-9	DM•••	E-19	DSB••	E-17
DCP••S	G-27	DFN100F-NPNF	K-9	DM•••••RAF	L-5	DSBV••	I-9
DCP••SWIV	G-23	DFN100-NC	K-8	DM•••••RAS	L-5	DSBV•••	I-9
DCP•SWIV	G-24	DFN100-NPNF	K-8	DM•••••RAT	L-5	DSCV••	I-30
DCP2023B	G-27	DFP••••	J-81	DM•••••UC	L-5	DSCV•••	I-30
DCP20B	G-27	DFP•••••F	J-81	DM••••RAF	L-5	DSK•••	M-8
DCP210•B	G-27	DFP•••••F-D	J-81	DM••••RAS	L-5	DST••	E-17
DCP214••	G-28	DFP••F••S	J-81	DM••••RAT	L-5	DSTW	M-10
DCS•	G-29	DFP••NYFD••NYFD	J-81	DM••••UC	L-5	DTW•••	E-71
DCS••	G-28, G-29	DFR••••	J-81	DM150SDB	K-26	DW••••	M-15
DCS••••	G-30	DFR•••••F	J-81	DMH••••	J-95	DWG050	K-27
DCS•••••F	I-54	DFVS••	E-18	DMH•••••D	J-97	DWL100	M-10
DCS•••••F••	I-54	DG•••	G-128	DMH•••••F	J-95	DX••••	L-21
DCS4025F••	I-54	DG••••	G-128	DMH•••••F-D	J-97	DXHDR25HC	L-19
DCS4030NYFD	I-54	DG•••••	G-128	DMH•••••NYFD	J-96	DXHDR25PB	L-19
DD	C-10	DGA•••SS	A-10	DMH••F••F	J-95	DXHDRC25HC	L-19
DDA•••••105	A-8	DGA•••SS•••	A-10	DMH••F••F-D	J-97	E••F••	H-38
DDA•••••105FL	A-8	DGA•••SSFL	A-10	DMH••F••S	J-95	E••F•••	H-38
DDA•••AL	A-8	DGC•••SS	A-10	DMH••F••S-D	J-97	E••F•••S	H-38
DDA•••AL••TTMA	A-8	DGD•••	A-10	DMH••NYFD••NYFD	J-96	E••M••	H-38
DDA•••ALFL	A-8	DGD••••	A-10	DMH••S••S	J-95	E••M•••	H-38
DDA•••BR	A-8	DGH7	E-48	DMH••T••S	J-95	E••M•••B	H-38
DDA•••BRFL	A-8	DGH7C	E-48	DMH••T••T	J-95	E••BF••B	H-38
DDA•••SS	A-8	DGH7CV	E-48	DMH20DR20	I-88	E••F••	H-38
DDA•••SSFL	A-8	DGH7P	E-48	DMH25F25NYFD	J-96	E••F•••	H-38
DDC•••••105	A-7	DGH7PSS	E-48	DMOCA••225F	I-61	E••F•••S	H-38
DDC••••AL	A-7	DGH7V	E-48	DMP•••••	J-97	E••M••	H-38
DDC••••BR	A-7	DGHW7	E-48	DMP•••••F	J-97	E••M•••B	H-38
DDC••••SS	A-7	DGLBV••	I-18	DMP••F••S	J-97	E••M•••S	H-38
DDC••••SSFL	A-7	DGLBV•••	I-18	DMP••F••T	J-97	E••S••	H-39
DDC400AL164TTMA	A-7	D-H4F4-S	H-5	DMP••S••T	J-97	E••S•••B	H-39
DDDC•••	A-8	D-H4F4-SS	H-5	DMR•••••	J-97	E73•••MB	G-105
DDDC300105	A-8	D-H4F4-SV-8	H-5	DMR•••••F	J-97	E73••A	G-105
DDDP•••	A-7	DHR•	L-22	DMR••F••S	J-97	E73••M	G-105
DDDP300105	A-7	DHS•••••	L-40	DMR••F••T	J-97	E74••A	G-105
DDSA•••SS	A-9	DHS•BF	J-126	DMR••S••T	J-97	E74••A-MB	G-105
		DHS159-1•••	L-40	DMXL••	E-19	E74••M	G-105
		DHS90•••	L-40	DN•	J-58	E74••M-MB	G-105
				DN••	J-58	EA•F•	H-40



Part Number Index

Page #	Page #	Page #	Page #
EC••• J-47	F••V-SKIT H-22	F72G•A G-92	FFBSO150 K-16
EK602• G-117	F•E-SKIT H-39	F72G•A-MB G-92	FFBSO150NST K-16
EK602VB G-117	F•H-BSKIT H-7	F72G•M G-92	FFBSON150 K-16
EL••••• E-64	F•H-SKIT H-7	F72G•M-MB G-92	FFBSON150NST K-16
EL••••• E-60, E-64	F•V-SKIT H-22	F73G•A G-93	FFC••• I-22
EL••H•M E-24	F03-0•A G-61	F73G•A-MB G-93	FFH•••F J-79
EL•F•F J-12	F03-0•AMB G-61	F73G•M G-93	FFH•••NYFD J-79
EL•H•M E-24	F03-0•M G-61	F73G•M-MB G-93	FFH••F•F J-79
EL•H•MSS E-24	F03-0•MMB G-61	F74C•A-MB G-94	FFH••T•S J-79
EL45•• J-15	F07•••A G-91	F74G•A G-93	FFH15NYFD15NYFD J-79
EL45••• J-15	F07•••M G-91	F74G•A-MB G-93	FFN••• K-19
EL90•• J-12	F07-200•C G-90	F74G•M G-93	FFN•••NST K-19
EL90••• J-12	F08-0•M G-61	F74G•M-MB G-93	FFN75GHT K-19
EL90•••B J-12	F08-0•MMB G-61	F74H•A-MB G-94	FFS••• I-22
EL90•••FS J-12	F08-02A G-61	F74V•A-MB G-95	FGH•• L-27
EL90•••G J-12	F08-02AMB G-61	FA•• J-45	FHCS150 J-115
EL90•••SS J-12	F16••A G-65	FAB••• E-8	FHHR•• L-22
EL90••FS J-12	F16••AMB G-65	FAB•••N E-9	FHHR-C L-22
EL90••G J-12	F16••M G-65	FAPRAV250F I-47	FHHR-C• L-22
EL90••SS J-12	F16••MMB G-65	FAPRAVF250 I-47	FHPR150 L-23
ENBG1 G-56	F17•••A G-94	FAPRAVG250• I-47	FHPR150••CBF L-23
ENBL A-18	F17•••M G-94	FAPRV•250 I-47	FHPR150-100CBF L-23
ENBL-P A-18, A-22	F18••A G-65	FBB••• E-8	FHPR2515 L-23
ENBL-P• A-22	F18••AMB G-65	FBSO100• K-19	FHR-C L-18
ENBL-PLUG A-18	F18••M G-65	FBSO100•-PG K-19	FHR-C1 L-18
ER•••• E-70	F18••MMB G-65	FBSO150• K-19	FHR-V• L-18
ER••••• E-70	F18-C00• G-94	FBSO150•-PG K-19	FJB-•••• H-77
ERJ A-18	F23-04M G-83	FBV•• I-5	FJB-20Z-20 H-77
ERJ-C A-18	F26••A G-65	FBV••• I-5	FJC-•••• H-77
ERS A-18	F26••AMB G-65	FBV•••SE I-6	FJC-20Z-20 H-77
ERS-C A-18, A-22	F26••M G-65	FBV••SE I-6	FJC45-•••• H-78
ERS-C• A-22	F26••MMB G-65	FBVG•• I-6	FJC45-20Z-20 H-78
ERS-CAP A-18	F28••A G-66	FBVG••• I-6	FJC90-•••• H-78
ETP M-5	F28••AMB G-66	FBVL•• I-5	FJC90-20Z-20 H-78
EZL•00-B-•• D-7	F28••M G-66	FBVL••• I-5	FJC-T•• H-78
EZL•00-C-•• D-7	F28••MMB G-66	FC••• J-100	FJR-T•• H-78
EZL•00-D-•• D-7	F30••A G-66	FC•••• E-62, E-64	FJS-•••• H-77
EZL•00-DC-•• D-8	F30••AMB G-66	FC••••• E-58, E-64	FJS-20Z-20 H-77
EZL•00-G-BU D-8	F30••M G-66	FC•••••ST••• E-58	FJS45-•••• H-78
EZL•00RPLKIT D-8	F30••MMB G-66	FC•••••ST•• E-63	FJS45-20Z-20 H-78
EZLCL400 D-8	F35-0•AMB G-66	FC•••F J-100	FJS90-•••• H-78
	F35-0•MMB G-66	FC•••F• J-100	FJS90-20Z-20 H-78
F• F-6, F-10	F-4EA-SKIT H-40	FC•••F-D J-103	FL••• C-23
F•• F-6, F-10	F-4N-SKIT G-12	FCB48 L-24	FL•••• C-23
F••• F-6, F-10	F602-••4A G-112	FCM•••• E-62	FLBV•••CS I-15
F•••• C-23	F602-••8A G-112	FCSB••• E-9	FLC0318-•• J-70
F••••• C-23	F602-••BJ G-112	FCSM••• E-9	FLC0319-•• J-70
F••E-SKIT H-39	F602-••BJR G-112	FD47-C2 L-20	FLC2402-•••• J-68
F••G-•••• C-37	F602-••WJ G-112	FD47IR-150-100 L-20	FLC2403-•• J-69
F••H-SKIT H-7	F602-••WJR G-112	FFB••• I-22	FLC2404-•• J-68

Index

Part Number Index

Index

	Page #		Page #		Page #		Page #
FLC2404-...••	J-68	FMR•••••	E-65		G-86	FST••	E-4
FLC2405-••	J-69	FMR•••••	E-65	FRP-96-•••	G-85	FST•••	E-4
FLC2405-...••	J-69	FMS•••	J-32	FRRE-T••	H-79	FST•••F	J-128
FLC2500-••	J-70	FMS••••	J-32	FR-RS	A-15	FST••CS	C-48
FLC2501-••	J-69	FN••NST	K-12	FR-RS-C	A-15	FSW•	J-115
FLC2501-...••	J-69	FN••S	K-12	FR-RS-R	A-15	FT••	J-16
FLC2603-••	J-70	FN600	A-15	FRR-T••	H-79	FT•••	J-16
FLG•••E	J-45	FN600B	A-15	FRS	A-15	FT•••FS	J-16
FM•••	J-32	FN600BL	A-15	FRS-C	A-15	FT•••G	J-16
FM••••	J-32, J-88	FN600BL-NI	A-16	FRSGX••	L-39	FT•••SS	J-16
FM••••F	J-88, J-89	FN600B-PLUG	A-15	FRSGX110	L-39	FT••B	J-16
FM••••F-D	J-87	FN600S	A-17	FRT••••	J-17	FT••FS	J-16
FM••••NYC	J-89	FNB••NST	K-12	FRX	A-16	FT••G	J-16
FM••••NYFD	J-89	FNB••S	K-12	FRX-C	A-16	FT••SS	J-16
FM••••T	J-88, J-89	FNB75GHT	K-12	FRXCAP	A-16	FT6••	A-27
FM••F••F	J-88, J-89	FNB75GHT-GD	K-30	FS•	F-6	FT6••••	A-27
FM••F••F-D	J-87	FNB75S	K-12	FS••	F-6	FT600	A-27
FM••F••NYC	J-89	FNBE150NST	K-13	FS•••	F-6	FT600•	A-27
FM••F••NYFD	J-89	FNBE150S	K-13	FS2403-•	H-55	FT600SC	A-27
FM••F••S	J-88, J-89	FNG••NST	K-13	FS2403-••	H-55	FT620•	A-26
FM••F••S-D	J-87	FNG••S	K-13	FS2404-•••	H-55	FTH100	L-41
FM••F••T	J-88, J-89	FNPSO150-••	K-20	FS2404-...••	H-55	FVFA••	E-18
FM••F••T-D	J-87	FNS	A-17	FS2408-•	H-56	FVL••	E-18
FM••NYFD••F	J-89	FNS2	A-17	FS2408-••	H-56	FVS••	E-18
FM••NYFD••T	J-89	FNSID	A-17	FS2501-•••	H-56	FVSP••	E-18
FM••S••	J-88	FO•	F-6	FS2501-...••	H-56	FWV••F••F	I-40
FM••S••F	J-88, J-89	FO••	F-6	FS2603-•	H-56	FWV••S••S	I-40
FM••S••F-D	J-87	FO•••	F-6	FS2603-••	H-56	FX1500	A-16
FM••S••T	J-89	FOS•	F-6	FS304C-•	H-56	FX1500P	A-16
FM••S••T-D	J-87	FOS••	F-6	FS304C-••	H-56	FX1500PLUG	A-16
FM25NYC25F	J-89	FOS•••	F-6	FS6400-•••	H-55	FX1500S	A-16
FM25NYC25T	J-89	FP•••	J-105	FS6400-...••	H-55	FX1500SP	A-16
FMB•••	J-32	FP••••	E-66	FS6500-•••	H-55		
FMB••••	J-32	FP•••••	E-60, E-66	FS6500-...••	H-55	G•••••HRPSS	D-62
FMBTFLY••F••F	I-52	FP•••F	J-105	FS6602-•	H-56	G••••-00	J-51
FMBV••F••F	I-42	FP•••F-•	J-105	FS6602-••	H-56	G••••-A-••	D-61
FMBV••S••S	I-42	FP•••F-D	J-105	FS6801-•••	H-55	G••••-AA-••	D-60
FMF•••	H-66	FP475S	K-23	FS6801-...••	H-55	G••••-C-••	D-61
FMF••••	H-66	FP500•	K-23	FSA••••F	J-107	G••••-DA-••	D-60
FMF••••-45	H-66	FR3C••••	J-121	FSA••••S	J-107	G••••E	J-48
FMF••••-90	H-66	FR3C6025F	J-121	FSA••••T	J-107	G••••-E-••	D-61
FMF••••-45	H-66	FRA	A-15	FSB	A-17	G••••T	J-48
FMF••••-90	H-66	FRA-C	A-15	FSCV••	I-29	G••••V	J-48
FMGR••F••F	I-51	FRA-NI-C	A-16	FSCV•••	I-29	G••••-A-••	D-54
FM •••••	E-65	FRC4025	J-119	FSGLBV••	I-18	G••••-AA-••	D-60
FM ••••••	E-65	FRC4025F	J-119	FSGLBV•••	I-18	G••••-A-ALNST	D-63
FM •••••••	E-65	FRC6025	J-119	FSGR•••F	I-51	G••••-B-••	D-55
FMR•••	J-32	FRC6025F	J-119	FSGV••	I-17	G••••-B-••••	D-55
FMR••••	J-32	FR-CAP	A-15	FSGV•••	I-17	G••••-B-ALNST	D-63
FMR•••••	E-65	FRP-95-•••	G-54, G-85,	FSGV•••F	I-39	G••••BL	J-43



Part Number Index

Page #	Page #	Page #	Page #
G...C... D-56	GBR... G-121	GLP... G-125	H...BU J-38
G...C... D-56	GBR... G-121	GLS... G-125	H...Y50SZ L-15
G...C...CR C-40	GBRW... G-127	GLSC... G-125	H...Y50UC L-15
G...D... D-57	GBRW... G-127	GLSS... G-126	H...BF... H-4
G...D... D-57	GBRW... G-127	GLSS... G-126	H...BF...-B H-4
G...D-ALNST D-63	GBRW30R G-127	GLSS... G-126	H...BF...-S H-4
G...DC... D-59	GC... C-2	GLSS... G-126	H...BF...-SS H-4
G...DC... D-59	GC... G-119, G-124	GLSSC... G-126	H...BU J-38
G...DD... D-60	GDB... C-4	GM... C-4	H...DC-A H-6
G...DP... D-59	GDB... C-4	GM... C-4, G-49	H...F... H-4
G...E J-48	GDF... C-12	GMAS... C-5	H...F...-B H-4
G...E... D-58	GDF... C-12	GMAS... C-5	H...F...-S H-4
G...E...CR C-41	GDL... C-12	GNB75GHT K-30	H...F...-SS H-4
G...F... D-58	GDL... C-12	GPA-95... G-87 to G-89	H...BF... H-3
G...F-ALNST D-63	GF... C-2	GPA-95-292 M-6	H...BF...-B H-3
G...HRP D-62	GF... C-2	GPA-96... G-88, G-89	H...BF...-S H-3
G...HRPSI D-62	GF... C-2	GPA-97... G-89	H...BF...-SS H-3
G...HRPSS D-62	GF...P... C-4	GROOVLUB32 J-49	H...DC-A H-6
G...N J-43, J-48	GF...P... C-4	GRP-95... G-85 to G-87, G-89	H...F... H-3
G...T J-43, J-48	GF26-1 C-2	GRP-96... G-85 to G-87, G-89	H...F...-B H-3
G...V J-48	GFAS... C-5		H...F...-BOP H-36
G...VB J-43	GFAS... C-5		H...F...-S H-3
G...A... D-54	GFN150 K-18	GS...-4 G-119	H...F...-SS H-3
G...B... D-55	GFN150NST K-18	GS...-4 G-119	H...F...-SS-BOP H-36
G...C... D-56	GFR... A-17	GS...-4 G-119	H...M... H-3
G...D... D-57	GFR... A-17	GSAFETYCLIP D-62	H...M...-S H-3
G...DC... D-59	GFR1... A-17	GSS... G-120	H...OF... H-3
G...DP... D-59	GFR1... A-17	GSS... G-120	H1DC H-6, H-32
G...E... D-58	GH... C-9	GSS... G-120	H4F4-HV H-5
G...F... D-58	GHC7 E-47	GSS... G-120	H5... C-27
G...HRP D-62	GHGN E-50	GSS...-4 G-120	H5...-BU C-27
G...HRPSI D-62	GHN75 K-15	GSS...-4 G-120	H5...NST C-27
G10 A-51	GHN75-B K-15	GSS...-4 G-120	H5...R100UC L-13
G3050 A-39	GHV E-49	GSS...-4 G-120	H5...R50UC L-13
G400-LT-AL D-60	GHY E-49	GSTC... E-4	H515R100... L-13
G5... C-27	GHYV E-49	GSTC... E-4	H515R50... L-13
G75HRPSS D-62	GIBFV... J-47	GWDGV250F I-35	H52...-A C-27, C-29
G9 A-51	GJ... C-12	GWH... M-12	H52...-A-BU C-27, C-29
GAM... G-3	GL... G-49, G-119, G-124	GWH... M-12	H52...L-A C-29
GAM... G-3, G-4	GL...FG G-122	GWH1*00R M-12	H52...L-A-BU C-29
GAS...NO F-22	GLBR... G-127	GWHC M-12	H525R100... L-13
GAS...NOS F-22	GLBR... G-127	GWH-C M-12	H525R50... L-13
GAS...TO C-24	GLBR... G-127	GWHC-FF M-12	H610Y50... L-15
GAW J-114	GLBR...-4 G-127	GWHZ... M-13	H615Y50... L-15
GB... C-2, C-3	GLBR...-4 G-127	GWHZ...R M-13	H625Y50... L-15
GB... C-2, C-3, C-41	GLBR...-4 G-127		HA... J-84
GB6-1 C-2	GLBR100004 G-127	H... J-38	HA...ADP J-99
GBA... C-12	GLBRC... G-127	H... C-32, J-38	HA...-D J-87
GBB... C-12	GLBRC... G-127	H... C-31	HA...F J-84
GBR... G-121	GLBRC... G-127	H...-BU C-31	HA...F-D J-87

Index



Part Number Index

Index

	Page #		Page #		Page #		Page #
HA***T	J-84	HGV250F-D	I-37	HSR**	L-19	HU100***BW	J-29
HA***T-D	J-87	HGV250-H	I-37	HSR***	L-19	HU1002***	J-30
HA**NYFD**F	J-86	HGV-HDWHL	I-38	HSRC**	L-18, L-19	HU1002***BW	J-30
HA**NYFD**S	J-86	HGV-KNOB	I-38	HSRC***	L-19	HU1502***	J-31
HA**NYFD76	J-86	HGVW250F	I-38	HSS*	F-2	HU1502***BW	J-31
HA**S**	J-84	HGVW250-W	I-38	HSS**	F-2	HU200***	J-29
HA**S**F	J-84	HHA****	J-86	HSS***	F-2	HU200***BW	J-29
HA**S**S	J-84	HHCI	E-35	HST**	E-2	HU206***	J-29
HA**S**T	J-84	HHD**P	H-81	HST**P	H-80	HU400***	J-30
HA**T**F	J-84	HHD**T	H-81	HST**T	H-80	HU602***	J-30
HA**T**S	J-84	HHP**M	J-20	HSTBC**	F-16	HU602***BW	J-30
HA023*	C-37	HHTP	M-5	HSTBC***	F-16	HUC207400	C-15
HA024*	C-37	HN	A-19	HT**BF**	H-10	HUF*****CS	C-13
HA0900-*	J-31	HN***SS	J-10	HT**F**	H-10	HUF206400FLG	C-16
HA2515F	L-24	HN**SS	J-10	HT**OF**	H-10	HUF206400FLG-45	C-16
HA25NYC76	J-86	HN**M**M	J-10	HT*BF*	H-10	HUF206400FLG-ST	C-16
HA25NYFD15NYFD	J-86	HNBGH**	E-40	HT*BF**	H-10	HUFALL***CS	C-13
HAB***EZ	D-31	HNBGHF**	E-40	HT*BF**-SS	H-10	HUM*****CS	C-14
HAC***EZ	D-31	HN-P	A-19	HT*BF*-SS	H-10	HUM206400FLG	C-16
HAD***EZ	D-31	HN-PLUG	A-19	HT*DC	H-11	HUM206400FLG-45	C-16
HB**	E-51	HP*	F-5	HT*F*	H-10	HUM206400FLG-ST	C-16
HB***	G-49, J-6	HPBV**	I-14	HT*F**	H-10	HUMF*****CS	C-13
HB***B	J-6	HPBV***	I-14	HT*F**-SS	H-10	HUP207400	C-15
HB***FS	J-6	HPBV***SAE	I-14	HT*F*-SS	H-10	HUS500RN	C-15
HB***G	G-49, J-6	HPBV**-3WAY	I-14	HT*JB*	H-11	HVF***-25	J-118
HB***SS	J-6	HPBV**SAE	I-14	HT*M*	H-10	HVG0***-25	J-118
HB*F*M	J-7	HPBV**SS	I-14	HT*OF*	H-10	HWH50	L-28
HBC**S	F-8	HPFN150	K-11	HT*OF**	H-10	HWH50-75	L-28
HBC*S	F-8	HPFN150NST	K-11	HT*OM*	H-10	HY*	C-8, H-76
HC30143	L-24	HPSG	K-32	HT*RB*	H-11	HY**	H-76
HC90	L-36	HPSGHD	K-32	HTBC**	F-16		
HC90RB	L-36	HPSGL	K-32	HTBG	G-58	IA***TP	M-6
HD1-*	F-19	HPSGW	K-32	HTBG*	G-58	IB**	D-14
HDBF75	I-87	HR	A-19	HTBG**	G-58	IBFVW***	I-19
HDPE***	J-50	HR1610	L-22	HTBG**EXT	G-58	IBFVW***E	I-19
HDPE***BU	J-50	HR1610-*	L-22	HTBG*EXT	G-58	IBR***	L-31
HDSSF75	I-87	HR-C	A-19	HTBG-CT	G-58	IBV**	I-14
HFN***	K-11	HRC-***	F-19	HTE*BF*	H-13	IBV***	I-14
HFN***NST	K-11	HR-CAP	A-19	HTE*BF**	H-13	IBV50BOV	M-6
HFN150NYFD	K-11	HS*	F-2	HTE*F*	H-13	IC**	D-16
HFN-P*	A-22	HS**	F-2	HTE*F**	H-13	ICL***	L-30
HFR-C*	A-22	HS***	F-2	HTE*OF*	H-13	ID**	D-21
HGB***NST	K-12	HS***AL	K-5	HTE*OF**	H-13	ID***TC	M-6
HGB100S	K-12	HS***SS	K-5	HTM***	F-5	IH**	D-27
HGCFB***NST	K-14	HS*BF*	H-14	HTSW	J-113	IH6	D-45
HGCFB150S	K-14	HS*BF*-B	H-14	HTW**P	H-80	IHC***F	J-103
HGG100NST	K-13	HS*BF*-S	H-14	HTW**T	H-80	IHSC152	D-45
HGG100S	K-13	HS*F*	H-14	HU*****N	C-15	IHSC34	D-45
HGV250	I-37	HS*F*-B	H-14	HU*****RN	C-15	IRC4025	J-119
HGV250F	I-37	HS*F*-S	H-14	HU100***	J-29	IRC4025F	J-119

Part Number Index

Page #	Page #	Page #	Page #
IRC4025GF J-119	KNW** E-15	L26-**AMB G-77	LSS** F-14
ISCS4025F I-53	KRH** L-28	L28-**A G-78	LSS*** F-14
ITD-** H-77	KRH*** L-28	L28-**AMB G-78	LV*N6D G-84
ITDH H-77	KRN*** E-7	L30-**A G-78	LV*NAD G-84
IXAN** C-34	KRN**** E-7	L30-**AMB G-78	LW**200 L-40
IXF** C-26	KRW* E-15, K-22	L606-**4B G-115	M* C-9
IXFDPLG*** C-33	KRW** E-15, K-22	L606-**B G-115	M** C-9
IXFS** C-34	KRW*** E-15	L606-**W G-115	M**** E-61
IXFS32-3A C-34	KS* F-7	L72M* G-101	M*****RAF L-3
IXH** C-25	KS** F-7	L72M*MB G-101	M*****RAS L-3
IXM** C-25	KS*** F-7	L73M* G-101	M*****RAT L-3
IXMS** C-34	KSS** G-48	L73M*MB G-101	M**-***UC L-2
IXPE32-3A C-33	KSV10-*** I-27	L74C* G-104	M**-**GAX L-4
IXSE** C-33	KSW** G-48	L74C*MB G-104	M**-**KAF L-4
IXSE**-3A C-33	KVW** E-15	L74M* G-102	M**-**KAS L-4
IXV** C-26		L74M*MB G-102	M**-**RAF L-3
	L** J-40	L74M*MBPX G-103	M**-**RAS L-3
J** F-18	L*** J-40, J-46	LCJS**-** M-3	M**-**RAT L-3
J** D-51	L**** J-46	LCJS12-15 M-3	M**-**UC L-2
J*B* G-33	L**-A-SS D-9	LCLD M-3	M*200 G-53
J*F* G-32	L**BU J-40	LCTS* M-3	M*F* G-34
J*M* G-32	L**-C-SS D-9	LCTS14 M-3	M*M* G-34
J*S* G-32	L**-DC-SS D-10	LDC2 I-24	M*S* G-34
J2F2-B G-32	L**-DP-SS D-10	LDCF2 I-24	M16**-A G-67
J2M2-B G-32	L**-E-SS D-10	LDCM2 I-24	M16**-M G-67
J47 C-12	L**-HSCRIP-SI D-11	LFV** I-6	M16-03A M-6
J844**-*-100 L-31	L**BU J-40	LFV*** I-6	M16-03M M-6
J844**-BL-100 L-31	L0*BL J-43	LHC95 L-36	M18**-A G-67
JS*** F-8	L03-0*A G-63	LHC95RB L-36	M18**-M G-67
JX** F-18	L03-0*AMB G-63	LHFS400F J-117	M2*2-B G-34
	L07-***A G-92	LHFS4045F J-117	M26**-A G-67
K* F-7	L07-200AC G-90	LHW J-115	M26**-M G-67
K** F-7	L08-02A G-63	LJ** J-36	M28**-A G-68
K*** F-7	L14AM7-G** J-133	LJ*** J-36	M28**-M G-68
K**BF** H-24	L14AM7-G*** J-133	LJR** J-36	M2B2 G-35
K**F** H-24	L14AM7-G**** J-133	LLBV2515F I-41	M30**-A G-68
K*BF* H-24	L14AM7-R** J-133	LOCKINGDEVICE J-112	M35-0*AMB G-69
K*BF*-SS H-24	L14AM7-R*** J-133	LOCKINGDEVICE6 J-112	M5834F E-44
K*F* H-24	L14AM7-R**** J-133	LP** C-9	M5834HM E-44
K*F*-SS H-24	L14AM7V-R*** J-166	LP*** C-9	M5834M E-44
K*OF* H-24	L14AM7X-R*** J-166	LPB** C-9	M7400-*** H-71
K4*-DC H-25	L16**-A G-76	LR*** E-66	M7400-*** H-71
K4DC H-25	L16**-AMB G-76	LR**** E-66	M7455-*** H-71
KB** C-3	L17-***A G-102	LR7 D-53	M7455-*** H-71
KHN*** E-7	L17-***D G-104	LRHEZ** D-11	MA*** E-8
KLW* E-15	L17-800APX G-103	LRHEZ34 D-11	MA***N E-9
KLW** E-15	L18**-A G-77	LRP-95-*** G-87	MAH* F-2
KM** E-20	L18**-AMB G-77	LRP-96-*** G-87	MAH** F-2
KM*** E-20	L2*2 G-38	LS** F-14	MB*** E-8
KNW* E-15	L26**-A G-77	LS*** F-14	

Index



Part Number Index

Index

	Page #		Page #		Page #		Page #
MBV••	I-7	MOC3025F-•	J-88	N36-••S••T	J-98	N54-••S••S	J-94
MC•••	I-23	MOCA250F	I-61	N36-••T••F	J-98	N54-••S••T	J-94
MC••••	E-62, E-63	MP••••	E-65	N36-••T••T	J-98	N54L-••F••F	J-94
MC•••••	E-59, E-62, E-63	MP•••••	E-61, E-65	N37-••F••F	J-90, J-91	N54L-••F••T	J-94
MC•••••ST•••	E-59	MPB-••••	H-77	N37-••F••G	J-90, J-91	N56-••F••F	J-85
MC•••••ST••	E-63	MPB-20Z-20	H-77	N37-••F••S	J-90, J-91	NAPRAV••F••	I-44
MCH50	L-29	MPC-••••	H-77	N37-••F••T	J-90, J-91	NAPRAVF•••••	I-44
MCM••••	E-62	MPC-20Z-20	H-77	N37-••G••F	J-90	NAPRAVGFT•••••	I-46
MCM••••XL	E-65	MPC-T••	H-78	N37-••G••S	J-90	NAPRAVGT•••••	I-46
MCS•••	E-9	MPR-T••	H-78	N37-••G••T	J-90	NAPRVF•••••	I-45
MD•••••T	E-68	MPS-••••	H-77	N37-••S••F	J-90	NAPRVFT•••••	I-46
ME•••	J-52, J-53	MPS-20Z-20	H-77	N37-••S••G	J-90	NAPRVGT•••••	I-45, I-46
ME•••••	J-54	MRCH••	J-4	N37-••S••S	J-90, J-91	NCS-CSF-STZ•••	J-110
ME••••••	J-52	MRCH•••	J-4	N37-••S••T	J-90, J-91	NCS-CSF-STZ•••C	J-110
ME•••••••	J-53	MS•	C-8, H-76	N37-••T••F	J-90, J-91	NF307Y50GHT	L-14
ME•••F••	J-54	MS••	C-8	N37-••T••S	J-91	NF307Y50GHT-KIT	L-14
ME•••FS••	J-54	MS•••	I-23	N37-••T••T	J-91	NF610Y100•••	L-14
ME•••S	J-52, J-53	MS•••••T	E-67	N3CS4	G-12	NF610Y50•••	L-14
ME•••S••	J-54	MS••X•	C-8	N4BF•	G-10	NF615100RAQT	L-14
ME•••S•••	J-52	MS••X••	C-8	N4BF•-B	G-10	NF615-50RAQT	L-14
ME109-NH3-1	J-54	MS•X•	C-8	N4BM•-B	G-11	NF615Y100•••	L-14
ME3162-32B	J-53	MS•X••	C-8	N4BM•-LS	G-11	NF615Y50•••	L-14
ME3162-32S	J-53	MSA••••F	J-109	N4DC	G-12	NFSGX••	L-39
ME502-12/8	J-52	MSA••••S	J-109	N4DC-B	G-12	NFSGX110	L-39
MEP120B	J-53	MSA••••T	J-109	N4F•	G-10	NG••	J-37
MEW•	J-53	MSBC•••SS	A-13	N4F•-B	G-10	NK2S2	G-40
MFB•••	I-22	MSBC•••SSFL	A-13	N4F•-B-LS	G-10	NORG74DISPLAY	G-90
MFC•••	I-22, I-23	MSBC•••SSMNPT	A-13	N4F6-S	G-10	NPT•••TC	M-6
MFC•••••	I-22	MSP•••	K-36	N4M•-B	G-11	NV•F	I-25
MFS•••	I-22, I-23	MSP4PAK	K-36	N4M•-B-LS	G-11	NV4M	I-25
MFS•••••	I-22	MSP-95-•••	G-85	N4M•-LS	G-11	NW••	J-37
MGC•	F-3	MT•••	G-130	N4M6-S	G-11	NW•••	J-37
MGC••	F-3	MT••••	J-44	N4M6-S-LS	G-11	NZ••••	K-36
MGC•••	F-3	MT•••••	J-44	N4S•	G-12	NZ••••S	K-36
MH•	F-2	MT••••••	J-44	N4S•-B	G-12	NZ6540QCS	K-36
MH••	F-2	MTP-95-•••	G-85	N4S•-B-LS	G-12	NZMMEG5P-•••	K-36
MIC••	J-18			N4S•-B-LS-WF	G-13	NZMQC5P-•••	K-36
MIC•••	J-18	N••	E-5	N4S•-B-WF	G-13		
MICAP••	J-19	N•••	E-5	N4S•-LS	G-12	O•••BU	C-14 to C-16
MICAP•••	J-19	N•••NO	E-5	N4S•-LS-WF	G-13	O246BU	A-33
MICAP•••G	J-19	N••CS	C-48	N4S•-S	G-12	O249BU	A-33
MICAP•••G	J-19	N•BM•	G-11	N4S•-S-LS	G-12	OA••	M-14
MIRU7550	J-5	N•M•	G-11	N4S•-WF	G-13	Oct-32	J-33
MIU••	J-5	N35-••F••F	J-83	N53-••F••F	J-82	OCTOE32	J-32
MIU•••	J-5	N35-••S••F	J-83	N53-••F••T	J-82	OCTOES32	J-32
ML•00M	G-53	N35-••S••S	J-83	N53-••S••S	J-82	OCTS••	J-33
MLS••	E-12	N36-••F••F	J-98	N53-••S••T	J-82		
MOC•••F••	J-88	N36-••F••T	J-98	N54••-25F25F	J-117	P••	F-24
MOC250NYC-P	J-88	N36-••S••F	J-98	N54-••F••F	J-94	P••E-SKIT	H-39
MOC250NYFD-P	J-88	N36-••S••S	J-98	N54-••F••T	J-94	P••H-SKIT	H-7

Part Number Index

Page #	Page #	Page #	Page #
P-••V-SKIT H-22	PGH50 L-27	PPA•• D-64	PVFP••• I-15
P-•E-SKIT H-39	PGS•• G-121	PPA••• D-64, E-55	PVFPN••• I-16
P-•H-BSKIT H-7	PGS••• G-121	PPB•• D-64	PVFPS200 I-16
P-•H-SKIT H-7	PGS•••• G-121	PPB••• D-64	PVFPSA200 I-16
P-•V-SKIT H-22	PHFA6 L-24, M-11	PPC•• D-65	PV-HDWHL I-51
P1A-•••A G-92	PHFA-B-A M-11	PPC••• D-65	PV-KNOB I-51
P1A-•••M G-92	PHL• G-15	PPCF•• E-55	PVN200 I-16
P-4EA-SKIT H-40	PHL••FS G-15	PPCM•• E-55	PW••F••F I-42
P4F• G-14	PHL••WF G-16	PPD•• D-66	PW••S••S I-42
P4F•-B G-14	PHL•FS G-15	PPD••• D-66	PW6••B100••• L-12
P4F6-9 G-14	PHL•WF G-16	PPDV75 I-50	PW6••B50••• L-12
P4F6-S G-14	PHL1• G-15	PPE•• D-67	PWH•• L-28
P4M• G-15	PHL12SS G-15	PPE••• D-67	PWH••• L-28
P4M•-B G-15	PHLB1• G-15	PPF•• D-67	PYLS•••• J-51
P4M6-9 G-15	PHW J-114	PPF••• D-67	PYLS••••• J-51
P4M6-S G-15	PL•• G-52	PPH•• D-68	
P8A-860• G-105	PL•••L G-52	PPH••• D-68	Q•CAP G-12
PAP250 J-104	PL400LWF G-53	PPH•00H D-68	QB• G-12
PBC250 J-103	PL400WF G-53	PPLSS•• E-53	QB•• G-11, G-12
PBLSS•• G-123	PLUG•••F-C J-104	PPM• E-54	QB••WF G-13
PBLSS••• G-123	PLUG•••S-C J-104	PPN•• E-51	QB•WF G-13
PBLSS•••• G-123	PM• G-15	PPN••• E-51	QB10• G-10
PD•F• H-32	PM•• G-15	PPP•• D-68	QB8• G-10
PD•M• H-32	PM12SS G-15	PPP••• D-68	QBM• G-12
PD•OM• H-32	PMB1• G-15	PPP•00H D-68	QM• G-12
PEDF200 I-87	PMB8 G-15	PPSO150• K-20	QM•• G-11, G-12
PEDF75 I-87	PML• G-14	PRC L-23	QM••WF G-13
PF• G-14	PML••FS G-15	PRN•••F L-23	QM•WF G-13
PF•• G-14	PML•FS G-15	PRWB L-23	QM10• G-10
PF12SS G-14	PML12 G-14	PS••• G-117, G-118	QM8• G-10
PFB•• G-14	PML12SS G-14	PS-12HF12-B H-14	QMCAP G-12
PFB8 G-14	PN•• J-32	PS403 G-85	QSS•• G-11
PFC250F J-102	PN•••• J-32	PS417B G-89	QSS103 G-10
PFC250U J-102	PN15 K-24	PS-H12F12-B H-14	QSS23 G-11
PFCW••• J-102	PN15F K-24	PSM•••• L-35	QSS4 G-12
PFCW•••F J-102	PNB75GHT K-29	PSN76 K-29	QSS83 G-10
PFCW•••F-Y J-102	PNS••• J-32	PSNP•••NYFD J-106	QTF••••-F E-69
PFL•• G-14	PNS•••• J-32	PSNP250••• J-106	QTF75GHT-F E-69
PFL••FS G-15	POLYHA•••• J-87	PSNP250S J-106	QTM••••-F E-69
PFL•FS G-15	POLYHA15S15F J-87	PSW J-113	QTM75GHT-F E-69
PFL12SS G-14	POLYHA2515F J-87	PSW• J-113	QTX150-F E-70
PFL8 G-14	POLYHA2520T J-87	PT•• G-130	
PFN4005• K-20	PP•VEU•-MG J-78	PTH-•••AG G-92	R•• F-24, J-42
PFNB•••S K-13	PP•VFC•-MG J-77	PTLS10040 J-51	R••• J-42
PFNB150NST K-13	PP•VFE•-MG J-77	PTLS7540 J-51	R•••BU J-42
PG700 G-56	PP•VMC•-MG J-77	PTP M-5	R••BU J-42
PG8083 M-7	PP•VME•-MG J-77	PTTF150• K-20	R••P• C-22
PGA•••NST K-17	PP•VTEU•-MG J-78	PU•••• L-35	R••P•LJR15 C-21
PGA150NPSH K-17	PP•VUC•-MG J-78	PV••• I-15	R••P•SOR15 C-21
PGH100 L-27	PP250F J-104	PVFP•• I-15	R03-0•R G-61

Index



Part Number Index

Index

	Page #		Page #		Page #		Page #
R03-0•RG	G-61	R515-50CBF/F	L-13	R-CR	A-20	RGF••P•	C-4
R07-•••R	G-91	R515U100•••/F	L-12	R-CR-C	A-20	RH•••BL	D-27
R07-•••RG	G-91	R515U100CBF	L-12	R-CR-CAP	A-20	RH•••EZ	D-28
R07-200RGC	G-90	R515U100CBF/F	L-12	RD•••BL	D-21	RHA••••	J-85
R08-02RG	G-62	R515U50•••	L-12	RD•••EZ	D-22	RHA••••F	J-85
R11-•••RG	G-97	R515U50•••/F	L-12	RD•••EZHD	D-22	RHA••••T	J-85
R11-••C	G-113	R515U50CBF	L-12	RD15•••	E-68	RHA••S••	J-85
R11-••CG	G-113	R515U50CBF/F	L-12	RD15193F	E-68	RHA••S••F	J-85
R119-••C	G-114	R72G••R	G-96	RDA••••BL	D-33	RHA••S••T	J-85
R119-••CG	G-114	R72G••RG	G-96	RDA••••EZ	D-33	RHA••T••F	J-85
R16-••R	G-71	R72M••R	G-98	RDA90•••EZ	D-37	RHC••	J-4
R16-••RG	G-71	R72M••RG	G-98	RDD••••EZ	D-34	RHC•••	J-4
R16-••RH	G-71	R73G••R	G-96	RDD•••EZ	D-34	RHC•••B	J-4
R16-••RHG	G-71	R73G••RG	G-96	RDL•••EZ	D-40	RHC•••FS	J-4
R17-•••R	G-97	R74G••R	G-97	RDM•	E-19	RHC•••G	J-4
R17-•••RG	G-97	R74G••RG	G-97	RDM••	E-19	RHC•••SS	J-4
R18-••R	G-71	R83-200R	G-98	RDWBPST•••EZ	D-42	RHC••B	J-4
R18-••RG	G-71	R91-221RG	G-98	RDWSP•••EZ	D-41	RHC••FS	J-4
R18-C05R	G-97	RA••	E-44	RE•••••••	D-24	RHC••G	J-4
R18-C05RG	G-97	RA•••	E-45	RE•••BT	J-150	RHC••SS	J-4
R200SS	D-51	RA79•	E-45	RE•••NO	D-24	RHEZ152	D-46
R21-••R	G-70	RAGG••••	J-45	RE•••PF	D-23	RHEZ175	D-46
R21-••RG	G-70	RAGG•••••	J-45	RE•••SE	J-150	RHEZ34	D-46
R26-••R	G-72	RAM•	G-2	REL••••	J-13	RHEZ6	D-46
R26-••RG	G-72	RAM••	G-2	R-EN	A-20	R-HN	A-21
R26-••RH	G-72	RAM•WF	G-5	R-EN-P	A-20	RHN••••SS	J-10
R26-••RHG	G-72	RAM7T	G-5	R-EN-PLUG	A-20	R-HN-P	A-21
R28-••R	G-73	RAS•••	E-46	REP•••AS	J-122	R-HN-PLUG	A-21
R28-••RG	G-73	RB•	C-6, C-10	REP•••AS•	J-122	R-HR	A-21
R30-••R	G-73	RB••	C-3, C-6, C-10	REP•••HY	J-122	R-HR-C	A-21
R30-••RG	G-73	RB•••BL	D-14	REP•••SP	J-122	R-HR-CAP	A-21
R30-••RH	G-73	RB•••EZ	D-14	REP•••SP•	J-122	RHS••	E-16
R30-••RHG	G-73	RB3-0•R	G-62	REP250PT	J-122	RHS•••	E-16
R364-••C	G-113	RB3-0•RG	G-62	REP400AS/SP	J-122	RHSC152	D-45
R364-••CG	G-113	RBU•	C-10	R-ER	A-20	RHSC175	D-45
R40-••RH	G-74	RBU••	C-10	R-ER-C	A-20	RHSC34	D-45
R40-••RHG	G-74	RC•••BL	D-16	R-ER-CAP	A-20	RIC150F	I-61
R40-0•R	G-74	RC•••BLNO	D-16, D-17	RES••	E-10	RJT-•••SP	J-153
R40-0•RG	G-74	RC•••BT	J-150	RES•••	E-10	RK•••	L-34
R43-•••RG	G-99	RC•••CEZ	D-17	RFC•••	J-100	RK••••	G-117
R46-•••R	G-54	RC•••EZ	D-18	RFC•••F	J-100	RKB605WB	G-118
R46-•••RG	G-54	RC•••EZ••	D-19	RFP•••F	J-105	RKHN•••	E-21
R504-••••	E-46	RC•••EZCR	C-39, D-18	RFST••	E-4	RKR•••Y	G-117
R515100•••	L-13	RC•••EZNO	D-18, D-19	RFST•••	E-4	RL••V	J-41
R515100•••/F	L-13	RC•••EZPF	D-18	RFST••CS	C-48	RLC•••EZ	D-9
R515100CBF	L-13	RC•••SE	J-150	RG••••	E-66	RLD200EZ	D-10
R515100CBF/F	L-13	RC••F•F	J-3	RG•••••	E-61, E-66	RLH•••EZ	D-10
R515-50•••	L-13	R-CN	A-20	RGB•	C-2, C-3	RLP••	C-9
R515-50•••/F	L-13	R-CN-P	A-20	RGB••	C-2, C-3	RM•	E-20
R515-50CBF	L-13	R-CN-PLUG	A-20	RGF••	C-2	RMA•••	E-46



Part Number Index

Page #	Page #	Page #	Page #
RMS• C-8	R-TN-PLUG A-21	SC•••ABS J-112	SF1631-••• A-52
RMS•• C-8	R-TR A-21	SC•••-NL J-112	SFBTFLY••••F I-52
RN•• E-5, E-21	R-TR-C A-21	SCCW••• F-20	SFC••• I-20
RN••• E-5, E-21	R-TR-CAP A-21	SCCW•••• F-20	SFC•••• I-20
RN•••NO E-5	RTW150 E-71	SCM•• G-164	SFMF••• H-66
RN••CS C-48	RWDGV250F I-36	SCS4025F I-53	SFMF•••• H-66
RNB150NST K-14	RWDGV3025F I-36	SCV••• I-28	SFMF••••-45 H-66
RNB150S K-14	RWF•• C-6	SCVH• I-26	SFMF••••-90 H-66
RNW•••-40 J-37	S•• E-8	SCVH•• I-26	SFMF•••-90 H-66
RNW••-40 J-37	S••• E-8, E-9	SCVJ• I-26	SFSA••••F J-108
RPA-95-••• G-86, G-89	S•••• E-67	SCVL• I-26	SFSA••••F-LH J-108
RPA-96-••• G-86	S•••••F E-67	SCVL•• I-26	SFSA••••S J-108
RPN•• E-28	S•••••X C-49	SCVM• I-26	SFSA30-••••F J-110
RRHS•• E-16	S•••X•••X120CS C-49	SCVM•• I-26	SFSA30-••••F-LH J-110
RRP-95-••• G-86, G-87	S•••X•••X090CS C-49	SCVR• I-26	SG••• F-9
RRP-95-590 G-89	S•••X•••X120CS C-49	SCVS• G-49, I-26	SGH•• L-27
RRP-96-••• G-86, G-87	S••N E-9	SCVS•• I-26	SGH••• L-27
RS15••• E-67	S6175 I-41	SCVV400 I-49	SGP••• J-112
RS15•••F E-67	S6175S I-41	SD•• E-11	SGS•••-NL J-112
RSDM•• E-11	S7100 I-41	SD•200 D-51	SGV••• I-39
RSE•••••F J-117	S7100-15 I-41	SD•300 D-51	SGV•••F I-43
RSE•••••F-C J-117	S7100-15S I-41	SD•400 D-51	SGVF••• I-43
RSF•••F J-80	S7337S I-41	SDMP•• E-11	SHD•S• G-38
RSF••F•T J-80	SA15Y57 G-118	SE•F•M J-13	SHD2•• G-37
RSFSA•••F J-79	SA161X57 G-118	SE45•• J-15	SHD4•• G-37
RSFSA••F•T J-79	SA200•W57 G-118	SE45••• G-49, J-15	SHP•• J-20
RSHR•• E-11	SA4050AL A-42	SE45•••G J-15	SHP••• J-20
RSK•• E-11	SAEB-•••• H-77	SE45••G J-15	SHP•••B J-20
RSM•••F J-92	SAEC-•••• H-77	SE90•• J-14	SHP•••FS J-20
RSM•••S J-92	SAHW J-113	SE90••• J-14	SHP•••G J-20
RSM••F•T J-92	SAP• E-5	SE90••B J-14	SHP•••SS J-20
RSMSA•••F J-93	SAP•• E-5	SE90••FS J-14	SHP••FS J-20
RSMSA250F-Z J-93	SAR10Y57 G-118	SE90••G J-14	SHP••G J-20
RSS•• E-16	SB•• E-8	SE90••SS J-14	SHP••SS J-20
RST• E-2	SB••• E-8	SEGC0-•••• L-42	SHS•• E-16
RST•• E-2	SB••N E-9	SEGC1-•••• L-42	SHS••• E-16
RST•••• E-4	SBC•••AL A-14	SEGS0-•••• L-42	SIC250F I-61
RST•••NOS E-6	SBC•••ALFL A-14	SEGS1-•••• L-42	SIC250F-• I-61
RST••A E-5	SBC•••ALMNPT A-14	SF•••F J-80	SJSS•••BB-20 J-185
RST••CS C-47	SBC•••ALTTMA A-14	SF•••F-• J-80	SJSS•••CC-20 J-185
RST••PF E-6	SBC•••SS A-14	SF•••F-D J-80	SK•• E-11
RSTB• E-3	SBC•••SSFL A-14	SF•••NYFD J-80	SK1098 F-13
RSTB•• E-3	SBC•••SSMNPT A-14	SF•••S J-80	SL•• G-9
RSTB••CS C-47	SBC-E300CC13 J-143	SF••F•T J-80	SL••• K-13
RSTV•• E-3	SBC-E300TP13 J-158	SF••F•T-D J-80	SL•••CR G-8
RSTV••CS C-47	SBCS G-7	SF•20FGXFGCS00 A-47	SL•••F G-8
RTCA•• A-48	SBDV•• I-43	SF•20FGXFGCS10 A-47	SL•••H G-8
RTCT•• A-49	SBG G-7	SF•20WXWCS00 A-47	SL•••M G-8
R-TN A-21	SC••• F-20	SF•20WXWCS10 A-47	SL075GHT K-13
R-TN-P A-21	SC•••• F-20	SF1471-••• A-52	SL150NST K-13

Index



Part Number Index

Index

	Page #		Page #		Page #		Page #
SLP1	G-9	SSBV**TW	I-8	STB***	E-3	SW***F	E-71, K-22
SLR•	G-9	SSC**	E-39	STB**CS	C-47	SW153	J-116
SLS***	E-12	SSCAP**	J-19	STBC***	F-15	SW1530	J-116
SLS4	C-3	SSCF**	E-39	STBC****	F-15	SW250	J-106
SLT10050	M-7	SSCF7**	E-39	STBC****L	F-17	SW300F	J-106
SM***F	J-92	SSC-T**-1	H-79	STBC***L	F-17	SWB-2	J-116
SM***F-D	J-92	SSC-T**-2	H-79	STC•	E-2	SWB-S•	J-116
SM***NYFD	J-92	SSCVIL***	I-29	STC**	E-2	SWCV**	I-30
SM***S	J-92	SSE**	M-11	STC***	E-2	SWCV***	I-30
SM**F**T	J-92	SSGV**	I-17	STC****	E-4	SWDS	K-31
SM**F**T-D	J-92	SSGV***	I-17	STC*****	E-4	SWDSHOSE**	L-8
SM**S**F	J-92	SSLBV**	I-10	STC**A	E-5	SWG300-4	M-7
SM515W50***	L-12	SSLBV***	I-10	STC**CS	C-47, C-49	SWMF***	K-5
SMB1525	J-112	SSLBV***SP	I-10	STC-180•-R***	J-182	SWMF-RK•	K-2
SMB450	J-112	SSLBV**SP	I-10	STC-360-R***	J-182	SWMF-RK**	K-2, K-5
SMV***	I-20	SSPM•	E-30	STC-RK***	J-182	SW-S400	J-116
SN***	I-21	SST**	J-17	STFC•	H-37	SZW2	J-116
SN****	I-21	SST***	J-17	STFC**	H-37	SZW2-NL	J-116
SN75	K-29	SST10	G-56	STFC•SS	H-37		
SO***	J-36	ST•	E-2	STFP•	H-38	T**	J-36, J-46
SO****	J-36	ST**	E-2	STFP**	H-38	T***	J-36, J-46
SOE**	J-17	ST***	E-2	STFP•B	H-38	T•DC	H-51
SOE***	J-17	ST**BF**	H-34	STFP•SS	H-38	T•F•	H-50
SOR***	J-36	ST**F**	H-34	STMC•	H-37	T•W7	E-47
SOT**	J-17	ST**OF**	H-34	STMC**	H-37	T16AMP-*****PL	J-196
SOT***	J-17	ST**PF	E-6	STMC•SS	H-37	T16AMP-*****PM	J-196
SP**	E-66	ST**SKIT	H-35	STMP•	H-38	T16AMP-***PL	J-196
SP***	E-61, E-66	ST•BF•	H-34	STMP**	H-38	T16AMP-***PM	J-196
SPA***	M-16	ST•BF**	H-34	STMP•B	H-38	T16W-***PL	J-196
SPA****	M-16	ST•BF**SS	H-34	STMP•SS	H-38	T16W-***PM	J-196
SPF***	I-21	ST•BF•SS	H-34	STR2***	J-34	T2CM-***PL	J-191
SRH360***-G***	J-182	ST•BF•-V2	H-34	STR3***	J-35	T2CM-***PM	J-191
SRH360***-R***	J-182	ST•DC-A	H-35	STR6648	J-35	T2CMP-***PL	J-191
SS***	E-14, E-43, F-9	ST•F•	H-34	STV**	E-3	T2CMP-***PM	J-191
SS***-	J-121	ST•F**	H-34	STV***	E-3	T2KM-***PL	J-192
SS16-•63	H-2	ST•F**SS	H-34	STV**CS	C-47, C-49	T2KM-***PM	J-192
SS2404-••	H-60	ST•F**V2	H-34	STW**	E-71	T2KMP-***PL	J-192
SS2404-***••	H-60	ST•F•SS	H-34	SUBV**	I-16	T2KMP-***PM	J-192
SS2405-••	H-60	ST•F•V2	H-34	SUBV***	I-16	T2KS-***PL	J-191
SS2405-***••	H-60	ST•OF•	H-34	SUBVN100	I-16	T2KS-***PM	J-191
SS2501-••	H-62	ST•OF**	H-34	SV**	G-162, I-27	T2S-***PL	J-191
SS2501-***••	H-62	ST•SKIT	H-35	SV***	G-49, I-27	T2S-***PM	J-191
SS337	C-6	ST16DC-A	H-35	SV***HD	I-27	T3114MP*****PL	J-194
SSA**	K-25	ST16F16-SS	H-34	SV***SS	I-27	T3114MP*****PM	J-194
SSA****	J-111	ST204B	F-9	SV**HD	I-27	T31W-*****PL	J-194
SSBV**	I-9	ST205G	F-9	SV**SS	I-27	T31W-*****PM	J-194
SSBV***	I-9	ST206R	F-9	SW**	E-11, J-116	T3214MP*****PL	J-195
SSBV***SR	I-11	ST8DC-A-V2	H-35	SW***	E-11, E-71, J-99,	T3214MP*****PM	J-195
SSBV***TW	I-8	STB•	E-3		K-22, L-24	T32W-*****PL	J-195
SSBV**SR	I-11	STB**	E-3	SW**••••••	J-27	T32W-*****PM	J-195



Part Number Index

Page #	Page #	Page #	Page #
T3F3-SSH-50	TL14AM7-...PLJ-133,	TSA••J-21	V••BF••H-17
T600-60FJ-37	J-196	TSE••J-23	V••BF••-BH-17
T7MP-...PLJ-193	TL14AM7-...PMJ-196	TSS••E-17	V••BF••-B-EH-20
T7MP-...PMJ-193	TLFS••E-53	TSSS••E-54	V••BF••-EH-20
T7RWWW-...PLJ-192	TLS••E-53	TSST••E-54	V••BF••-SSH-17
T7RWWW-...PMJ-192	TLSS••E-53	TT•50M-2	V••BF••-SS-EH-20
T7WWM-...PLJ-193	TLT••E-56	TT•75M-2	V••DC-AH-21
T7WWM-...PMJ-193	TM•E-54	TT•ASGA-33	V••F••H-17
T7WWMS-...PLJ-193	TM••C-20, E-54	TT•ASG-ETHA-33	V••F••-BH-17
T7WWMS-...PMJ-193	TM•••C-20	TT•ASGOEA-33	V••F••-B-EH-20
T7WWW-...PLJ-192	TM••••M-16	TT4ASG-ETHA-33	V••F••-EH-20
T7WWW-...PMJ-192	TM••-••C-21	TT4ASG-ETHOEA-33	V••F••-SSH-17
TA•••E-56	TM•••-••C-21	TTA50LPM-2	V••F••-SS-EH-20
TA••••M-16	TM502M-16	TTA50SSM-2	V••JM••H-16
TA•••FE-56	TML••C-20	TTB100M-2	V••M••H-16
TA502M-16	TML•••C-20	TTBP50M-2	V••M••-BH-16
TBC•••F-15	TML••-••C-21	TTC•J-24	V••M••-EH-19
TC97L-36	TMR••C-20	TTF•AL-•EMTA-30	V••M••-SSH-16
TC97RBL-36	TMR••••C-20, C-21	TTF•AL-•MTA-30	V••M••-SS-EH-19
TCF•J-24	TNA-19	TTF400SPA-30	V••OF••H-17
TCF••E-52, E-55	TN••E-51	TTF4AL-•FTA-30	V••BF•H-17
TCM••E-55	TN•••E-51	TTFS4AL-FP50A-31	V••BF•-BH-17
TCMR-T••H-79	TN••••E-51	TTFS4SSA-33	V••BF•-B-EH-20
TCN•••J-22	TN•••X•J-9	TTFST••CSC-48	V••BF•-EH-20
TCR-T••-••H-79	TN•••X•SSJ-9	TTFST••CS-THKC-48	V••BF•-SSH-17
TCS••••FI-55	TN-PA-19	TTPM••-•••M-2	V••BF•-SS-EH-20
TCS••••F-••I-55	TN-PLUGA-19	TTPM••-••••M-2	V•-BRKITH-23
TCT••A-49	TP••C-20	TTPM•••••M-2	V•DC-AH-21
TES-••-••H-78	TP•••C-20	TTPM••••••M-2	V•F•H-17
TETF4ALA-31	TP••-••C-21	TUN••FSJ-5	V•F•-BH-17
TETF4ALFP50A-31	TP••••C-21	TUN••SSJ-5	V•F•-B-EH-20
TETFG4ALA-31	TPF••E-57	TUN•FJ-5	V•F•-EH-20
TF••E-52	TPGM-9	TUN0••GJ-5	V•F•-SSH-17
TF••WF•-80C-22	TPL••C-20	TVPC200-300I-71	V•F•-SS-EH-20
TFKG-155	TPL•••C-20	TVS7-30E-47	V•JM•H-16
TFN150-•••K-15	TPM•E-57	TVSEC-G••I-72	V•M•H-16
TFN150NST-•••K-15	TPN••E-57	TWGV25M-7	V•M•-BH-16
TFS••E-52	TPP140K-39	TYP2501-••G-59	V•M•-B-EH-19
TFV••I-24	TPR••C-20	U•••J-71, J-72	V•M•-EH-19
TFV2HBI-24	TPR••-••C-21	UHGV250FI-37	V•M•-SSH-16
TG••C-20	TPS•J-24	UHGV250F-DI-37	V•M•-SS-EH-19
TG•••C-20	TPS••J-24	UHGV250-WI-37	V•OF•H-17
TG••-••C-21	TPX•J-24	UPP250FK-24, L-24	V•-RKITH-23
TG••••C-21	TPX••J-24	UPP250F-SPECK-24	V•-SSRKITH-23
TGL••C-20	TRA-19	UPPTK-24	V2DCH-21
TGL•••C-20	TR•••J-36	UPPT•••K-24	VEP••BF••H-48
TGL••-••C-21	TR•BF•H-52	USBGG-7	VEP••DC-AH-48
TGR••C-20	TR•F•H-52	USWJ-113	VEP••F••H-48
THB••J-21	TR-CA-19		VEP••F••-BOPH-49
THN••E-51	TR-CAPA-19		VEP••OF••H-48

Index



Part Number Index

Index

Page #	Page #	Page #	Page #
VEP•BF•H-48	W106-•••H-73	WDS1K-31	X02-04MBG-84
VEP•DC-AH-48	W106-•••••H-73	WDSRK-31	X03-02G-70
VEP•F•H-48	W4-•••••-UH-74	WF•C-6	X03-02MBG-70
VEP•F•-BOPH-49	W4-•••-UH-74	WF••C-6	X27F-19
VEP•OF•H-48	W43-•••••-UH-73	WF•••C-6	XLS-••A0120PI-86
VHC••• ..H-6, H-15, H-21	W44-•••••-UH-73	WF26-1C-6	XPO-•4FI-86
VHC••••H-15	W44-•••-UH-73	WH300-•D-51	XSO-4••••0AI-86
VHC•••BH-15	W45-•••H-73	WH400-•D-51	Y•••J-51
VHC•••NVH-18	W45-•••••H-73	WHYD••••FI-40	Y10075G-51
VHC•••SSH-15	W46-•••••-UH-73	WILK26DISPLAYG-89	
VHCN•••H-21, H-25	W46-•••-UH-73	WM•C-7	
VHN•••H-17, H-21	W48-•••••-UH-73	WM••C-7	
VHN••••H-17	W48-•••-UH-73	WN••J-33	
VHN•••BH-17	W49-•••H-73	WN•••J-37	
VHN•••NVH-20	W49-•••••H-73	WN1000J-37	
VHN•••SSH-17	W59-•••••-UH-74	WOC-T••L-38	
VN•••••-200J-47	W59-•••-UH-74	WP2H-••••I-59	
VNR•••••-200J-47	W60-•••H-74	WP2H••••I-59	
VR4030CS-ALA-28	W60-•••••H-74	WP2H-ASSP-•I-59	
VR4040CS-ALA-28	W61-•••H-74	WP3H••••I-59	
VR4040CSRK•A-28	W61-•••••H-74	WS••BF••H-44	
VR4050ALA-41	WA•G-46	WS••BF••-SSH-44	
VR4050PLA-41	WA2BG-46	WS••DC-AH-45	
VR4086A-40	WA2SSG-46	WS••F••H-44	
VR4086-BYA-40	WA4FL12X•••••C-16	WS••F••-BOPH-46	
VR6200A-37	WA4FL12X•••••••C-16	WS••F••-SSH-44	
VR6200NPA-37	WB•G-46	WS••F••-SS-BOPH-46	
VRC3000ALA-28	WB1CG-46	WS••OF••H-44	
VTA-17	WB1SSG-46	WS•BF•H-44	
VT7A-17	WBCC-7	WS•BF•-SSH-44	
VT9A-17	WBN•••G-47	WS•DC-AH-45	
VTTA-17	WD•01ALVBI-18	WS•F•H-44	
VTXA-17	WD•04ALVBI-18	WS•F•-BOPH-46	
VTX-9A-17	WD40M-8	WS•F•-SSH-44	
W•C-7	WDGV•••FI-35, I-36	WS•F•-SS-BOPH-46	
W••C-7	WDGV250NYFDI-35	WS•OF•H-44	
W••-•••-UH-73	WDGV3025FI-36	WSB-••L-37	
W••BF••-BH-42	WDH••BK••GAXL-7	WSB-••••L-37	
W••-BMFH-42	WDH••BK••KAFL-7	WSB-•••••L-37	
W••DCH-42	WDH••BK••KASL-7	WSB-••TL-37	
W••F••-BH-42	WDH••BK••RAFL-6	WSB-••T-•••L-37	
W••-RKIT-V2H-43	WDH••BK100RAFL-6	WSB-20ZL-37	
W•BF•-BH-42	WDH••BK100RASL-6	WSR•G-46	
W•-BMFH-42	WDH••BK100RATL-6	WSR•SSG-46	
W•DCH-42	WDH••BK100UCL-8	WSR1•G-46	
W•F•-BH-42	WDH••BK50RASL-6	WSS••F-4	
W•-RKIT-V2H-43	WDH••BK50RATL-6	WTB-T••L-38	
W104-•••H-73	WDH••BK50UCL-8	WTB-T••ZL-38	
W104-•••••H-73	WDN150K-28		
	WDN150NSTK-28	X02-04G-84	



Limited Warranty

DIXON VALVE AND COUPLING COMPANY (herein called "Dixon") warrants the products described herein, and manufactured by Dixon to be free from defects in material and workmanship for a period of one (1) year from date of shipment by Dixon under normal use and service. Its sole obligation under this warranty being limited to repairing or replacing, as hereinafter provided, at its option any product found to Dixon's satisfaction to be defective upon examination by it, provided that such product shall be returned for inspection to Dixon's factory within three (3) months after discovery of the defect. The repair or replacement of defective products will be made without charge for parts or labor. This warranty shall not apply to: (a) parts or products not manufactured by Dixon, the warranty of such items being limited to the actual warranty extended to Dixon by its supplier; (b) any product that has been subject to abuse, negligence, accident, or misapplication; (c) any product altered or repaired by others than Dixon; and (d) to normal maintenance services and the replacement of service items (such as washers, gaskets and lubricants) made in connection with such services. To the extent permitted by law, this limited warranty shall extend only to the buyer and any other person reasonably expected to use or consume the goods who is injured in person by any breach of the warranty. No action may be brought against Dixon for an alleged breach of warranty unless such action is instituted within one (1) year from the date the cause of action accrues. This limited warranty shall be construed and enforced to the fullest extent allowable by applicable law.

Other than the obligation of Dixon set forth herein, Dixon disclaims all warranties, express or implied, including but not limited to any implied warranties of merchantability or fitness for a particular purpose, and any other obligation or liability. The foregoing constitutes Dixon's sole obligation with respect to damages, whether direct, incidental or consequential, resulting from the use or performance of the product.

Some products and sizes may be discontinued when stock is depleted, or may require a minimum quantity for ordering.

Limits of Liability

This catalog is intended as a product offering. It is not intended to be a user or technical manual. Information in this catalog is subject to change without notice. All users and distributors of products sold through this catalog should contact Dixon® with questions of use, compatibilities, coupling procedures and life of product. Our full-time engineering and test staff are always available to recommend uses and to assist distributors and users with any questions.



Safety



Safety logos, which appear throughout our catalog, are used as a reminder that the user should carefully review for the appropriateness of the product for the media, application and environment in which it will be used.

NOTE: Because of the health hazards associated with contamination and lead content in drinking water systems, Dixon® couplings, unless otherwise specifically approved, are not recommended for potable water service and should not be used in applications where drinking water will contact the wetted surfaces of the coupling.

Warning: Dixon® products may contain chemicals known to the State of California to cause cancer, birth defects, or other reproduction harm.

Trademarks

Delrin® and Zytel® are registered trademarks of E.I. duPont Nemours and Company.

Kalrez® is a registered trademark of DuPont Dow Elastomers.

All other trademarks appearing in the Dixon® Illustrated Price List are the property of their respective owners.

Copyright

Copyright © 2017 by Dixon Valve and Coupling

All rights reserved. This book is copyrighted material. Use, reproduction or copying of it by anyone other than Dixon® is strictly forbidden without its express written consent.

NOTE: Reasonable care has been taken in preparing this Illustrated Price List. Dixon Valve & Coupling Company reserves the right to make corrections and price changes.

DPL417 INDEX

A Engineered Fluid
Transfer Couplings
pages Aiv - A52

B ADS Industrial
Fluid Controls
pages Bi - B6

C Coupling Systems
pages Ci - C51

D Cam & Groove
pages Dii - D-68

E Industrial Hose
Fittings
pages Ei - E72

F Clamps, Sleeves
and Ferrules
pages Fi - F27

G Pneumatic Fittings
pages Gii - G164

H Hydraulic Fittings
pages Hi - H81

I Valves
pages Iii - I88

J Pipe, Welding and
Tube Fittings
pages Ji - J197

K Nozzles, Spray Guns
and Accessories
pages Kii - K40

L Hose and Tubing
pages Li - L42

M Maintenance and
Repair
pages Mi - M16

N Technical
pages Ni - N15

O Index
pages O2 - O40

United States

Albany, NY
ph 518.725.0998
178A Corporate Drive
Gloversville, NY 12078
fx 518.725.8542

Atlanta, GA
ph 770.486.9619
101 T.D.K. Boulevard
Suite A
Peachtree City, GA 30269
fx 770.486.9813

Dallas, NC
ph 704.376.5755
2925 Chief Court
Dallas, NC 28034
fx 704.376.1557

Chestertown, MD
ph 800.355.1991
800 High Street
Chestertown, MD 21620
fx 800.283.4966

Chicago, IL
ph 630.323.3716
1011 N. Hilltop Drive
Itasca, IL 60143
fx 630.323.4120

Cleveland, OH
ph 330.425.3000
1900 Enterprise Parkway
Twinsburg, OH 44087
fx 330.425.1527



The Right Connection®

Dixon®
ph 877.963.4966
fx 800.283.4966
dixonvalve.com



Houston, TX
ph 713.678.4291
6525 Homestead Road
Houston, TX 77028
fx 713.678.8105

Kansas City, MO
ph 816.221.0064
1244 Saline Street
N. Kansas City, MO 64116
fx 816.221.1108

Los Angeles, CA
ph 909.605.6400
8840 Flower Road
Suites 150/160
Rancho Cucamonga, CA 91730
fx 909.605.6200

Portland, OR
ph 503.289.0400
2642 North Marine Drive
Portland, OR 97217
fx 503.289.0600

Salt Lake City, UT
ph 801.972.1180
McGillis Ind. Pk. Bldg., #4
1972 South 4370 West
Salt Lake City, UT 84104
fx 801.972.8063

Tampa, FL
ph 813.247.3500
5120 Adamo Drive
Suite E
Tampa, FL 33619
fx 813.247.7910

International

**Edmonton, Alberta,
Canada**
ph 780.469.5444
fx 780.463.9205

**Innisfil, Ontario,
Canada**
ph 705.436.1125
fx 705.436.6251

**Montreal, Quebec,
Canada**
ph 514.422.9292
fx 514.422.0166

**Wingfield SA,
Australia**
ph 61.8.8202.6000
fx 61.8.8202.6099

Preston, England
ph 44.1.77.232.3529
fx 44.1.77.231.4664

**Troisdorf-Spich,
Germany**
ph 49.2241.84406.0
fx 49.2241.8440679

Monterrey, Mexico
ph 52.81.8354.5649
fx 52.81.8354.8197

dixonvalve.com



customer service

